

REVISIONS

| ISSUE | DATE | AUTH. NO. |
|-------|----------|-----------|
| X2 | 6-25-62 | 73965 |
| X3 | 7-13-62 | 73938 |
| X4 | 9-26-62 | 74652 |
| X5 | 10-29-62 | 74963 |
| X6 | 2-12-63 | 75851 |
| X7 | 3-13-63 | 76027 |
| 8 | 6-24-65 | 87329 |
| 9 | 11-25-66 | 91976-1 |
| 10 | 5-2-67 | 93362 |

NO. NOTES

1. WIRING LEGEND:

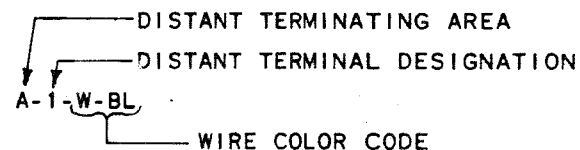

2. COLOR CODE:

- | | |
|------------|--------------------|
| BK - BLACK | W-BK - WHITE-BLACK |
| BR - BROWN | W-BR - WHITE-BROWN |
| R - RED | W-R - WHITE-RED |
| O - ORANGE | W-O - WHITE-ORANGE |
| Y - YELLOW | W-Y - WHITE-YELLOW |
| G - GREEN | W-G - WHITE-GREEN |
| BL - BLUE | W-BL - WHITE-BLUE |
| P - PURPLE | W-P - WHITE-PURPLE |
| W - WHITE | W-S - WHITE-SLATE |
| S - SLATE | |

3. CONNECTOR VIEWED FROM BOTTOM.

4. * ASTERISK DENOTES 18 GA. WIRE

5. THE 195648 STRAP IS NOT PRESENT IN EARLY MANUFACTURED UNIT.

F
 192013 KEYBOARD
 CONNECTOR (SEE NOTE 3)

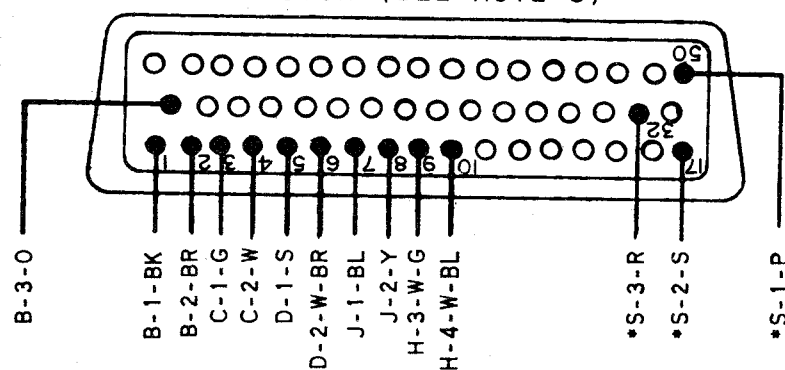

E
 151329
 BACKSPACE SWITCH

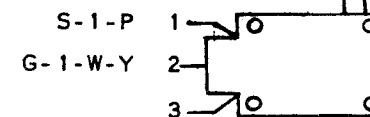

D
 178144 KEYBOARD
 UNIVERSAL CONTACT

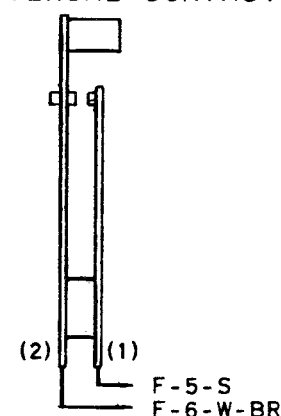

S
 151415
 MOTOR TERMINAL BLOCK

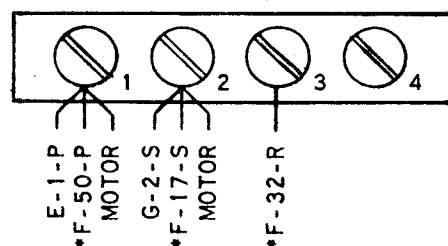

B
 176352
 KEYBOARD
 SIGNAL GENERATOR

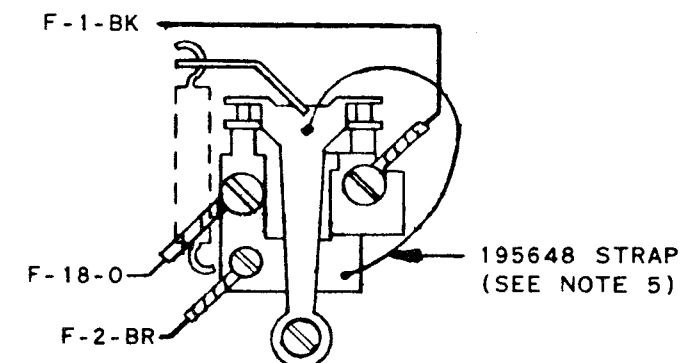

G
 BACKSPACE MAGNET

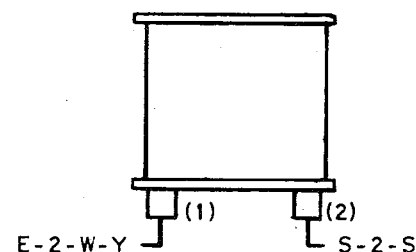

C
 324010
 192485 OR 319946
 TIMING CONTACT

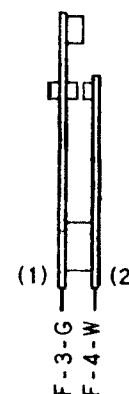

H
 REPERFORATOR SELECTOR
 MAGNETS

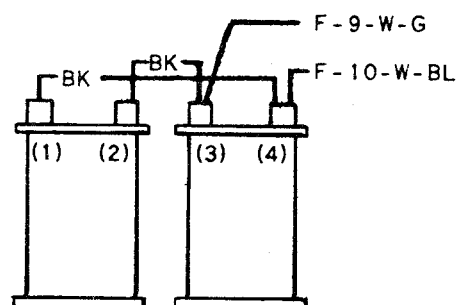

J
 END OF LINE
 INDICATOR SWITCH

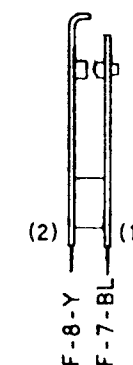

ACTUAL
 WIRING DIAGRAM
 FOR MODEL 35
 KEYBOARD
 LAK803

APPROVALS

D AND R
 E OF M

E-NUMBER

PROD. NO. 5811WD

DATE: 3-28-62

P.D. FILE NO. 1-30.151AA

DRAWN. V.E.S. CHKD.

ENG. W.M.B. APPD.

TELETYPE
 CORPORATION

RTTY ELECTRONICS
 TELETYPE=Sales-Service-Parts
 PO Box 20101 El Sobrante, Ca.
 94820. (510)222-3102
 mr_rtty@pacbell.net