

- NOTES**
1. WIRING LEGEND:
  2. NOTE NO.2 IS LOCATED IN LOWER CENTER OF DRAWING.
  3. MOTOR POWER FUSETRON OR FUSTAT AND ALTERNATE FUSE PROTECTION:  
 MOTOR FUSETRON OR FUSTAT ALTERNATE FUSE  
 115V A.C. - 60 CYCLES 57M. 3.2 AMP. 6 AMP.  
 115V A.C. - 60 CYCLES 60V. 1.6 AMP. 3 AMP.
  4. ASSOCIATED CABLES:  
 --- 136527 CABLE, CONTROL  
 --- 136551 CABLE, DRAWER  
 --- 136539 CABLE, BLINKER (MOD. KIT ONLY)  
 STRAPS ON TERMINAL BLOCK - 3952ERM.
  5. WIRE COLOR CODE AND SYMBOLS:  
 BK - BLACK O - ORANGE W - WHITE  
 BL - BLUE R - RED Y - YELLOW  
 BR - BROWN S - SLATE  
 G - GREEN V - VIOLET
  6. CONNECTORS SHOWN FROM PRONG AND SLOT ENDS.
  7. COLOR CODED STRAPPING INCLUDED IN ASSOCIATED CABLE.
  8. STRAPPING INDICATED BY DOUBLE LINE (====) IS NOT INCLUDED IN FORMED CABLE.
  9. TERMINAL DESIGNATIONS ENCLOSED IN PARENTHESIS ARE NOT MARKED ON COMPONENTS.
  10. WHEN MODIFICATION KIT NO. 136021 (FOR BLINKER OPERATION OF OUT-OF-TAPE LAMPS) IS USED, REMOVE THE FOLLOWING STRAPS:  
 WI03 TO WI09 WI04 TO WI10 WI05 TO WI11  
 WI06 TO WI12 WI07 TO WI13 WI08 TO WI14  
 AND CONNECT 136539 CABLE, BLINKER - TO THE 120-POINT TERMINAL BLOCK (LOCATED AT "W"), AS INDICATED.
  11. WIRING TO BE FURNISHED BY CUSTOMER IN THE FOLLOWING AREAS MARKED -  
 X AA AD AG AK  
 Y AB AE AH AL  
 Z AC AF AJ AM
  12. WIRING, TO BE FURNISHED BY CUSTOMER, SHALL BE CONNECTED IN THE FOLLOWING MANNER:  
 1. TERMINALS AA13, AB13 & AC13 SHALL BE STRAPPED TO EACH OTHER AND SHALL BE CONNECTED TO TERMINAL U2.  
 2. TERMINALS AA16, AB16 & AC16 SHALL BE STRAPPED TO EACH OTHER AND SHALL BE CONNECTED TO TERMINAL U1.

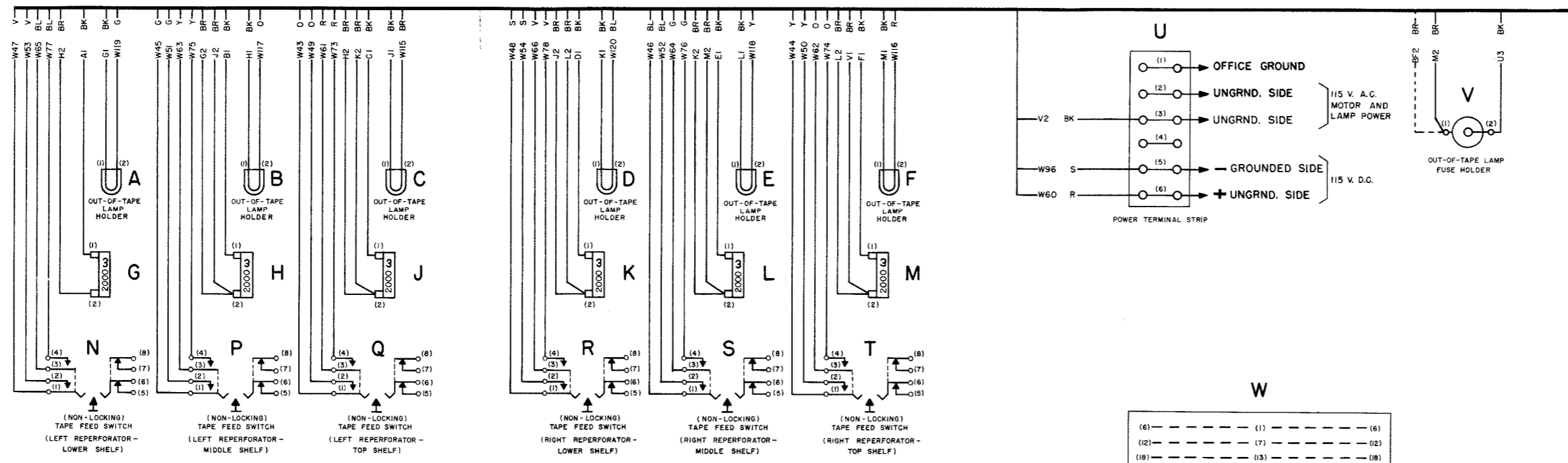

THE ABOVE WIRING OF THE LEFT HAND CONTROL PANEL AS VIEWED FROM THE FRONT OF THE CABINET WITH THE CONTROL PANEL FULLY OPENED (SHOWING BACK OF PANEL)

THE ABOVE WIRING OF THE RIGHT HAND CONTROL PANEL AS VIEWED FROM THE FRONT OF THE CABINET WITH THE CONTROL PANEL FULLY OPENED (SHOWING BACK OF PANEL)

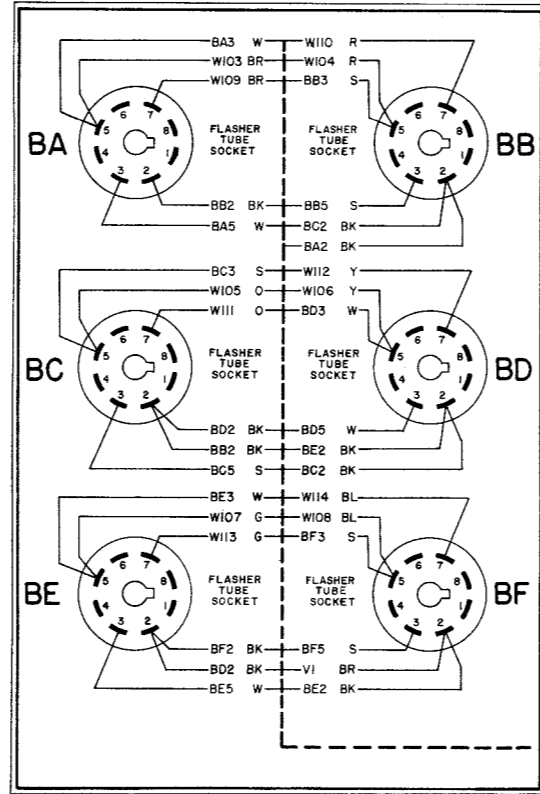
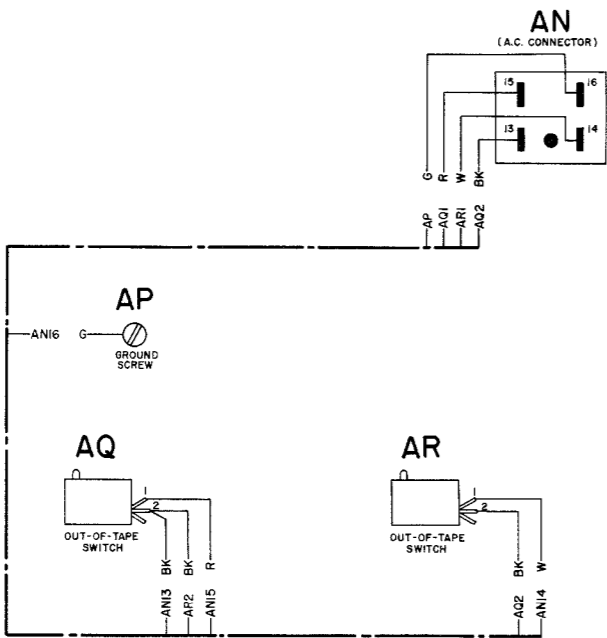

WIRING OF NO. 136021 MODIFICATION KIT

SEE NOTE NO. 10

NOTE NO. 2

TERMINAL NUMBER	TERMINAL POINT	COLOR	LEADS CONNECTED TO RIGHT SIDE OF 120-POINT TERMINAL BLOCK (VIEWED FROM REAR OF CABINET)		
1	25		49 Q 2 O 73 Q 4 R 97		
2	26		50 T 2 Y 74 T 4 O 98		
3	27		51 P 2 G 75 P 4 Y 99		
4	28		52 S 2 BL 76 S 4 G 100		
5	29		53 N 2 W 77 N 4 BL 101		
6	30		54 R 2 S 78 R 4 V 102		
7	31		55	79	103 BA 5 BR
8	32		56	80	104 BB 5 R
9	33		57	81	105 BC 5 O
10	34		58	82	106 BD 5 Y
11	35		59	83	107 BE 5 G
12	36		60 U 6 R 84	108 BF 5 BL	
13	37		61 Q 3 R 85	109 BA 7 BR	
14	38		62 T 3 O 86	110 BB 7 R	
15	39		63 P 3 Y 87	111 BC 7 O	
16	40		64 S 3 G 88	112 BD 7 Y	
17	41		65 N 3 BL 89	113 BE 7 G	
18	42		66 R 3 V 90	114 BF 7 BL	
19	43	Q I O	67	91	115 C 2 BR
20	44	T I Y	68	92	116 F 2 R
21	45	P I G	69	93	117 B 2 O
22	46	S I BL	70	94	118 E 2 Y
23	47	N I V	71	95	119 A 2 G
24	48	R I S	72	96 U 5 S	120 D 2 BL

NO. 136021 MODIFICATION KIT CONNECTIONS (SEE NOTE NO. 10)

X (SEE NOTE NO. 11)

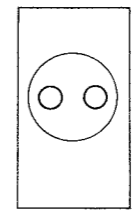

Y (SEE NOTE NO. 11)

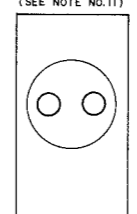

Z (SEE NOTE NO. 11)

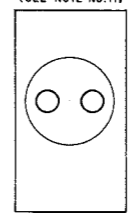

AA (SEE NOTE NO. 11)

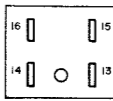

AB (SEE NOTE NO. 11)

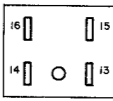

AC (SEE NOTE NO. 11)

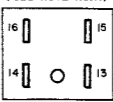

AD (SEE NOTE NO. 11)  
 CONNECT TO OFFICE GROUND

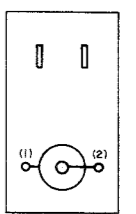

AE (SEE NOTE NO. 11)

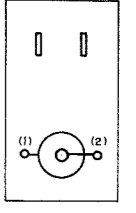

AF (SEE NOTE NO. 11)

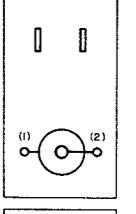

AG (SEE NOTE NO. 11)

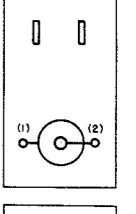

AH (SEE NOTE NO. 11)

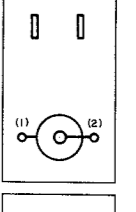

AJ (SEE NOTE NO. 11)

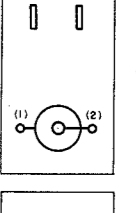

AK (SEE NOTE NO. 11)

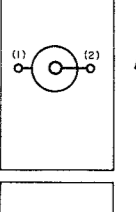

AL (SEE NOTE NO. 11)

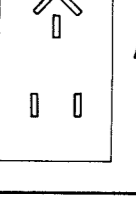

AM (SEE NOTE NO. 11)