

MOD-U-LINE CABINETS, ST-6 style MCP 3-17-12 \$27.97. Now shipping gray color in 24 hours. All Sizes available, but some not stocked. 1 day to 6 weeks delivery on some special sizes in tan or blue. Special sizes in gray or black 2-6 weeks. UT2 and UT4 Components available. Send stamp for our free catalog. NuData Electronics, Dept. B, 104 N. Emerson St., Mt. Prospect, IL 60056.

SALE: 28KSR MARK V III Keyboard \$75.00, 28 RO Base \$25.00, 28 KSR floor cabinet \$60.00, Typebox \$15.00, LESU \$15.00, and 28KSR 1/20 H.P. motor \$10.00 Wanted: Friction feed platen assem. for Mark III printer. Ed Wagner, 159 Lakewood Garden La., Madison, WI 53704.

TELETYPE PAPER, SINGLE SHEET rolls, not surplus. 12 roll case, white, 4 1/2 inch rolls, \$26.10 per case plus shipping (case wt. 36 lbs.) \$2.50 per single roll. N & S Print, P.O. Box 11184, Phoenix, Arizona 85061.

THE BEST IS EVEN BETTER: Topeka FM Engineering has unveiled its new 2 meter RF preamplifier. A successor to the legendary HF 144, the HF 144W employs the same reliable, low noise, dual gate MOS FET circuitry in a much smaller package. It occupies only two thirds of a cubic inch. True 19 dB gain with less than 2.5 dB insertion noise. Complete kit (\$12.00) includes drilled and etched P.C. board, connectors, mounting hardware, parts and instructions. Wired and Tested; only \$17.00. Order from Flesher Corp., P.O. Box 902, Topeka, Kansas, 66601. BankAmericard, Master Charge telephone orders accepted (913-234-0198) No COD.

WANTED: SELETRIC I/O, including interface, RS-232 or TTY, ASCII or BCD. B. Thurman, W8ISG, Galesburg, MI. 49053. (616)665-7071

PERFORATOR TAPE 11/16 w., case of 40 rolls - \$8.00 FOB. Limited quantity. Paul Davis, 1830 Toepfer Rd., Akron, Ohio 44312.

FIRST CLASS MAIL



RTTY JOURNAL
P.O. Box 837
Royal Oak, MI. 48068

RTTY September 1976

JOURNAL

EXCLUSIVELY AMATEUR RADIO TELETYPE

Volume 24 No. 7

35 Cents

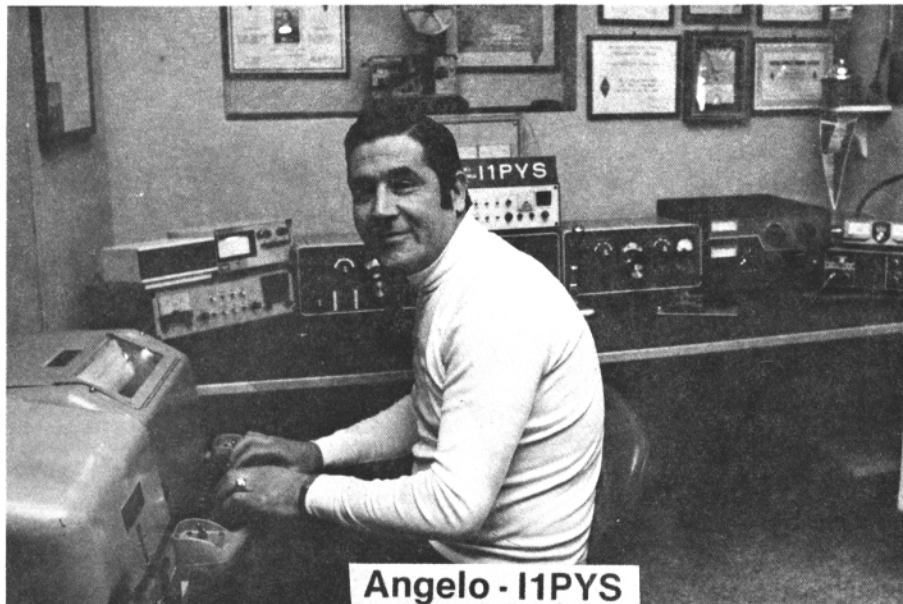

Angelo - I1PYS

Winner RTTY Championship.

CONTENTS-

CARTG DX SWEEPSTAKES - - - - -	2
RESULTS-VOLTA DX CONTEST - - - - -	2
HAL'S DX3000 KSR - - - - -	3
NOTES ON HAL DKB DUAL MODE KEYBOARD	4
LOOP SWITCHING - - - - -	6
MAINLINE EC-1 -EC-2 ERROR CORRECTOR	7
1 FINGER LTRS-FIGURES RETURN - - -	8
VHF NEWS - - - - -	9
NOISE IN GOVERNED MOTORS - - - - -	9
DX NEWS - - - - -	10
DXCC CERTIFICATE FROM ARRL. - - - -	11

CARTG. "Olympics" DX SWEEPSTAKES.

The Olympics are over but the big RTTY Olympics will be starting soon. The Canadian Amateur Radio Teletype Group (CARTG) RTTY DX Sweepstakes start October 2nd. Full rules and details below. This is usually the largest of all RTTY contests and this year promises to be bigger and better than ever. Many plaques, medallions and certificates await the various winners. Work some new countries, renew old friendships and have lots of fun by participating. Log sheets or further information is available from CARTG, 85 Fifeshire Rd., Willowdale, Ont. Canada - M2L 2G9. See you during the contest. Enclose IRS coupons for log sheets.

THE CANADIAN AMATEUR RADIO TELETYPE GROUP (VE3RTT) SPONSORS THE 16th ANNUAL W/W RTTY DX "OLYMPICS 21" SWEEPSTAKES

- Saturday, October 2nd, 0200 GMT to Monday, October 4th, 1976 0200 GMT. Not more than 30 hours of operation is permitted. Non-operating periods can be taken at any time during the Contest. Summary of times on and off must be submitted with score.
- BANDS** - All amateur bands 3.5 to 28 MHz.
- COUNTRY STATUS** - ARRL Country List - KLT, KH6, and VO to be considered as separate countries.
- CLASSIFICATIONS** -
 - Single Operator (one transmitter)
 - Multioperator (one transmitter)
 - SWL Printer
 Individual operators of multi-operated stations may submit their Logs singly instead of a Group Log.
- MESSAGE** - Message number, Time GMT and Zone.
- EXCHANGE POINTS** -
 - all points.
 - All others will receive points listed in Zone Chart (same as last year)
 - Stations may not be contacted more than once on any one band. Additional contacts counted on different bands.
- MULTIPLIERS** - Each country contacted including ones own on each band, e.g., If one country worked 3 bands, three multipliers given. **EACH USA and Canadian District will be considered a separate country.**

- SCORING** - Total Exchange Points x Number of countries worked x number of Continents (max. 6.) Canadian Bonus Points added last - 100 Bonus points for each VE/VO contact on all bands. Use separate Log Sheet for each band. Log Sheets and Zone Charts available for SAE or IRC's. Logs must be received before December 1st 1976 to qualify.

AWARDS

- Plaque - "C.A.R.T.G."
- Plaque - "RTTY JOURNAL"
- Plaque - "C.A.R.T.G."
- Plaque - "RTTY JOURNAL"
- Plaque - "C.A.R.T.G." Member
- Plaque - "C.A.R.T.G."
- Plaque - "RTTY JOURNAL"
- Plaque - "C.A.R.T.G."
- Plaque - "RTTY JOURNAL"
- Plaque - "C.A.R.T.G."
- High Score USA - Gold Medallion & Ribbon - "RTTY JOURNAL"
- High Score Canada - Gold Medallion & Ribbon - Director "C.R.R.L."
- Most 2-way RTTY contacts made with USA STATIONS - all bands - USA Bicentennial Plaque - "RTTY JOURNAL"
- Green RTTYer - (First RTTY Contest) Sidney Burnett Memorial Plaque
- Most 2-way RTTY contacts made with Canadian stations - all bands - Plaque - "VE2JR"
- SWL Printer - Plaque - "C.A.R.T.G."
- Multi-operated station high score - Plaque "RTTY JOURNAL"
- Most 2-way RTTY 40m contacts Plaque - "C.A.R.T.G."
- Low Power (under 100w) Plaque - "RTTY JOURNAL"
- Certificates for top scores in each USA & Canadian District and each Country.

All Plaques & Medallions to be engraved with winner's call.

Send Logs - Summary & Scores to:
Canadian Amateur Radio Teletype Group
85 Fifeshire Road
Willowdale, Ontario
CANADA M2L 2G9

Results - "VOLTA" DX RTTY CONTEST.

Score						S W L	
1) i8AA	44,535.600	23) SK5AA	1,396.271	45) VU2KV	48.960	1) Paul T. Menadier	6,035.328
2) W3EKT	28,519.670	24) G3ZWW	1,192.632	46) VE2QO	48.880	U.S.A.	
3) DL6TD	16,067.796	25) i1COB	1,036.800	47) SM6CAL	37.180	2) Horst Ballenberger	5,819.294
4) DL1VR	9,488.640	26) SM6EZD	973.028	48) G3TLC	36.110	West Germany	
5) HASKBM	7,679.182	27) ON4CK	787.136	49) IA1FFX	33.930	3) Wolfgang Geller	4,031.664
6) K4AGC	7,645.734	28) FO8BS	767.448	50) DJ2YE	33.744	West Germany	
7) W9HHX	7,307.400	29) K4CIW	767.232	51) CE3EX	30.140	4) Roberto Giannello	3,153.276
8) ZS6BNF	6,406.686	30) OK1MP	644.003	52) DK1AQ	27.324	i3-13018 Italy	
9) i5WT	5,970.432	31) DM2AYO	639.450	53) VE3BPM	25.536	5) Mario Tosolini	2,804.400
10) WA2JVB	5,708.430	32) OZ6SM	553.280	54) F6BIQ	12.000	i3-14258 Italy	
11) PJ3AR	5,487.768	33) OZ4DZ	503.470	55) DJ9IR	9.880	6) D.R. Hare	2,388.091
12) W3CRG	5,353.920	34) W4JNY	414.656	57) DL1OW	8.918	BRS-27239 Englar	
13) K6WZ	5,032.368	35) EA3AHM	344.432	58) HA0KDA	6.435		
14) W1GKJ	4,759.272	36) K9KXP	284.012	59) SM6ANW	4.015		
15) WA3JTC/ZP3	4,229.280	37) K1YGF	236.880	60) PA0WWDW	3.564		
16) HB9AVK	3,846.480	38) DL8VX	143.232	61) SM6GDL	3.024		
17) DL6QH	2,220.660	39) WA2YVK	129.584	62) PA0CWI	2.000		
18) CT1EQ	2,136.084	40) G3RDG	117.744	63) i6SNP	1.660		
19) W9OEQ	2,028.670	41) SM0OS	110.112	64) OZ8GA	1.550		
20) W9NLR	1,872.108	42) F6BEX	104.496	65) W8TCO	1.60		
21) W9BLUK	1,778.400	43) KZ5OD	96.600				
22) SM6ASD	1,647.135	44) G4ALE/A	63.336				

HAL'S DX 3000 KSR.

Ed TREGO, W9WKC
517 Market St.
Hoopeston, IL 60942

Several years ago in my original article in the RTTY Journal in which I described Hal's initial efforts at making the move from mechanical to electronic RTTY; I stated that to have something upon which to improve, something had to be in existence. At that time Hal came out with their RVD-1002 (character generator) and their RKB-1 (keyboard). Since that time progress has been rather rapid. The next generation of equipment was the RVD-1005 and the Morse-RTTY keyboard, DKB-2010.

Comes now, the DS-3000 KSR Video Display Terminal. With this unit we now have an exact duplicate of the usual mechanical KSR plus many more features not available in machines.

The design of the DS-3000 is such that the keyboard is very low and I find that when used at an ordinary desk height, it is quite comfortable for typing with no need to resort to special typewriter desks or those with a sunken recessed portion for a typewriter. The display can be permanently mounted on the keyboard with furnished brackets or mounted anywhere up to 100 ft. away, if one is so inclined.

The DS-3000 receives and transmits both ASCII and Baudot codes with either switch selectable. Baudot from 45 baud to 100 baud, 60 wpm, to 132 wpm ASCII from 110 to 1200 baud, 10 to 120 characters per second. The standard baud rates are selected in sequence from the slowest to the fastest with the rate in use appearing in the upper left hand corner of the screen. Such as, when first turning on the screen and terminal unit, the upper left hand corner of the screen exhibits BAUD-45. This article will only concern itself with the Baudot code since the only use we have for ASCII at the present time is to copy commercial stations.

Some of the features of the RVD-1005 and DKB-2010 combination have been improved upon. The display format is now 16 lines of 72 characters instead of 25 lines of 40 characters. Auto CR and LF is inserted at the end of the 72nd character. Non-over-print is achieved by ignoring received CR codes and generating LF as well as CR whenever a LF is received. Unshift on space is still switch selectable. The "Here is" key is now user programmable up to 255 characters and the program will remain in memory until the unit is turned off. The bell signal is translated into an audible tone instead of the former picture of a bell printed on the screen.

The cursor is now completely under control of the operator. It can be positioned anywhere on the screen. There are four keys with arrows in upper case which tell the direction in which it can be moved. Each depression of an arrow key moves the cursor up, down, backward or forward one space at a time. If a lot of

movement of the cursor is required it is much easier to use an arrow key in conjunction with the repeat key. There is one key which sends the cursor "home" and at the same time wipes the screen clean of anything behind the cursor. The cursor indicates where the next character is to be sent or received.

A 256 character buffer is now incorporated to accommodate typing "over runs", or enough for 3.5 lines of display; a very considerable improvement over the DKB-2010 storage capacity.

The completely new features of the DS-3000; not found in Hal's previous equipment or mechanical KSR's either, are "Word" transmission, "Line" transmission, "Page" transmission, "Word-wrap-around", and "Blankfill". None of these features are operative in the continuous transmission mode when each character is transmitted simultaneously with the actuation of each key.

The "word mode" is attained by placing the unit in "line" mode and then activating the proper keys at which time the words "Word Mode On" appear on the screen. When typing in the "word mode" a word is typed, but not transmitted, until the space bar is depressed, at this signal the word is then sent at the operating Baud rate in use. There are some secondary gains from using the word mode since a word is being typed, but not transmitted, it is subject to editing by the "rub-out" key which just simply backs up the cursor erasing a letter at a time. The word can then be corrected for spelling or accidental hitting of wrong keys before transmitting for public consumption. The "blankfill" can also be used in this mode and blanks will be transmitted whenever there is a pause in the typing. When the word mode is used this way with the "blankfill" the over-all impression at the receiving end is that tape transmission is being used since everything is sent at a fixed baud rate. I have also found that with the blankfill there is some help in keeping the receiving operator's machine in sync under adverse propagation or QRM conditions. The blankfill is switch selectable.

One of the nicest features of the DS-3000 is "word-wrap-around" which means simply that there are no split words at the end of the line. If more than 72 characters are typed between two CR's, the characters after the last space signal are moved down to the next line. It certainly makes for more pleasant reading than having all lines end at 72 characters regardless of whether the words do or not. This particular feature is available in both word and line modes, and is operable when receiving in continuous mode.

Line transmission operates in the same way as word transmission except that a complete line is sent minus any characters dropped to the next line because of the word-wrap-around at the baud rate in use after a CR.

In Page mode a whole screen can be typed

and edited and is not transmitted until the proper controls are actuated.

I have made no mention of what controls are used to put the DS-3000 into its various modes, memories, baud rates, etc., since it is of no interest to anyone not owning a DS-3000, and if he does, he has a big fat manual anyway. Suffice it to say, there is one key at the left of the keyboard marked CTL which is always used in conjunction with an letter key and sometimes also a shift key. For example: to enter data into the "here is" memory, a CTL, shift and letter "P" key are depressed simultaneously, the data entered, the same three keys again depressed and the data is permanently in the memory which is available at any time via the "Here is" button.

There are a few other little goodies not heretofore mentioned: a repeat key, a QBF test message and a keyboard operated switch which can be used to control the transmit-receive functions of the station.

I think we all have a way of coming to grips with our equipment, and each of us in his own way. My solution of the problem of calling CQ with a minimum of typing is to type one line of a

CQ into the "Here is" memory and then punch the "Here is" key for the required number of lines. If I get no answer I place the unit into "page mode", reposition the cursor under the top left "C" of the first CQ and retransmit the whole screen of CQ's. This can be done for any number of repetitions. The cursor moves through the screen indicating which character is being transmitted.

From the above, it is apparent that the DS-3000 KSR has the same capability as a mechanical typing-reperforator, at least up to 16 lines of 72 characters. Anything which appears on the screen can always be put on the air regardless of how it got there, whether from the keyboard or an incoming signal.

It now seems such a short way to go to make the DS-3000 KSR into an ASR. All that is required is a fairly extensive memory and a means of connecting the keyboard to it while receiving over the air print on the screen. I feel certain Hal will come up with something in this direction in the way of plug-ins or add-ons. Then the operator can in effect "pull tape" while receiving.

Notes on the HAL DKB 2010

JOHN POSSEHL, W3KV
PO Box 73
BLUE BELL, PA. 19422

Dual Mode Keyboard.

We would like to bring to your attention two simple modifications to this popular solid state keyboard. Both mods require a minimum of parts, are extremely easy to apply, and if you are a fairly slow typist like myself you will enjoy using this excellent piece of gear more than ever before. First a word about the keyboard. In basic form it has a three character buffer memory with optional 64 and 128 character memories available. When you have typed 64 letters, figures, or spaces, a lamp lights and an audio tone on the speaker tells you that you have reached the end of the line and to use the CR/LF keys. In addition there are extra keys programmed to automatically send "CQ", "DX", "Here is", "QBF" etc., when you depress the proper key. In the information to follow we will be only interested in the "AUX" key which is usually factory programmed to send "DX". The modifications themselves do not require getting into or changing any of the existing circuitry in any way with the exception of re-programming the diode matrix of the "AUX" key as you will see later. Only four wires are tack soldered to specific points on the logic circuit board. Both modifications are explained and shown on an overlay of Dwg. B-1025 of the manual (Fig. 1), however, due to the drawing density and the need to photo reduce it to get it on the page here it may be difficult to see, so the mods will be spelled out in text also.

Mod. Nr. 1, by Heinz Schilling, DJ1XK.

This modification will automatically insert a "Ltrs" or a "Figs" signal between each character typed and depending whether you happen to be in upper or lower case at the time. Parts required are a 10K 1/4 watt resistor,

4 SEPTEMBER 1976

a germanium diode (1N270), a .001 disc capacitor, and a miniature on/off switch.

- Connect the diode and 10K resistor in parallel and then connect the cathode end of this junction to one side of the switch.
- The anode side of the junction goes to the .001 capacitor.
- The remaining side of the capacitor goes to the junction of C1, C2, R10, R11 on the logic board. Tack solder.
- The remaining side of the switch goes to Pin G of I.C. 19 (7404). Tack solder.

With the switch open the keyboard functions normally. With the switch closed a "FIGS" or "LTRS" signal will be inserted between each character typed. For the operator it allows for more relaxed typing as you will only have to type at about half the baud rate you happen to be using, on the receiving end the printed characters come out at a rhythmic rate with what appears to be a pause between each printed character. If you happen to have one of the optional 64 or 128 character buffer memories installed you will find that you can easily load the storage and at sign off you can open the switch and the storage will dump out at the standard speed without the "diddle". All four selectable baud rates on the keyboard act in the same way and the mod has no effect at all on the CW mode.

Mod Nr. 2, by Paul Kung, HB9AVK.

This modification will automatically transmit CR/LF after 64 characters and/or spaces are typed. This will occur at the same time that the lamp lights and the tone sounds in the speaker. This mod only requires a single silicon diode (1N4148, 1N914, etc.)

- Cathode end of diode to Pin 13, IC 23 (7373). Tack solder.

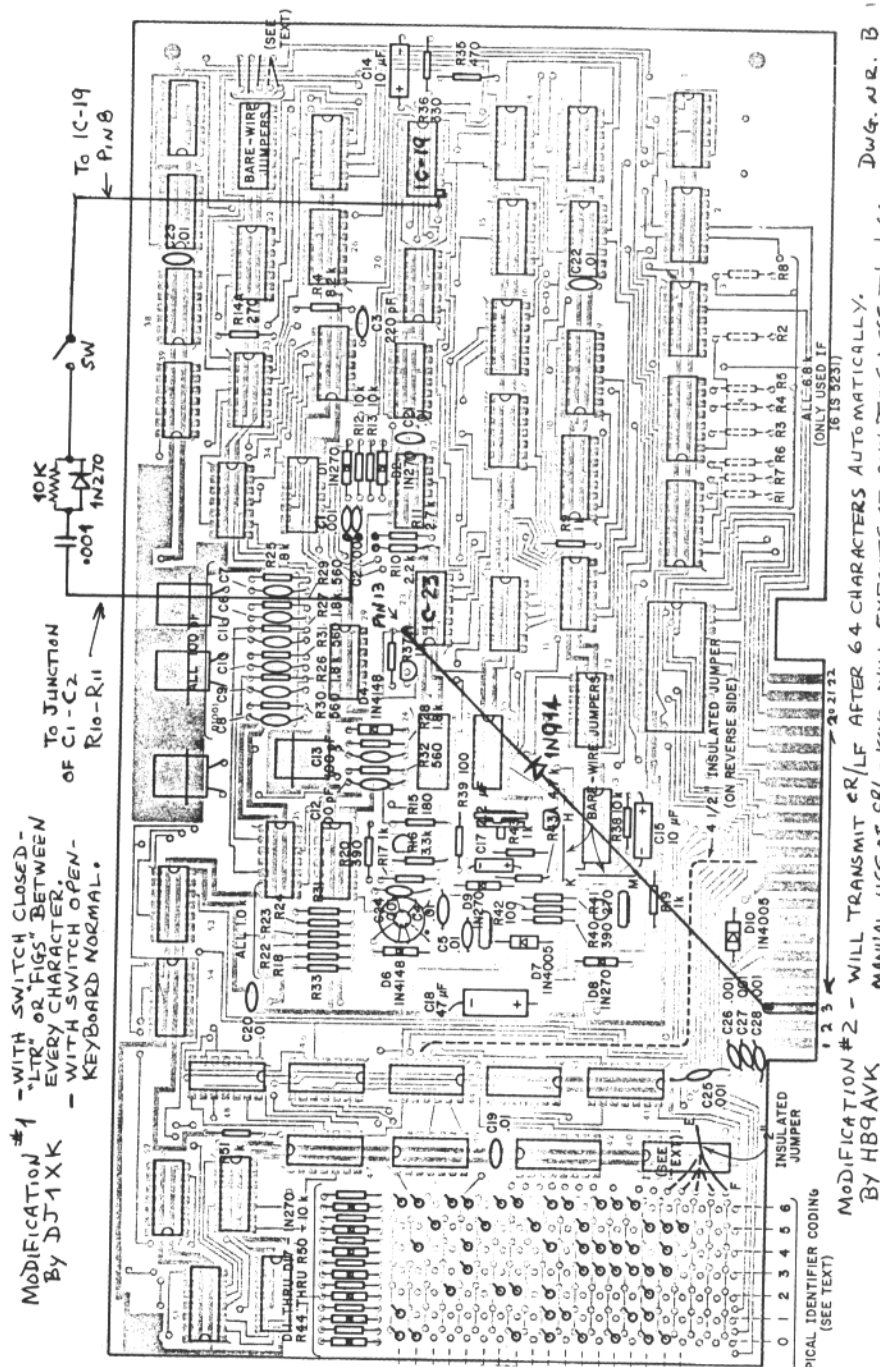

Dwg. Nr. B-1025
 MANUAL USE OF CR/LF KEYS WILL EXECUTE AT ANY TIME LESS THAN 64 CHAR. FIG. 1

- B. Anode end of diode to Pad #3 of the 22 pad edge connector on the logic PC board. Tack solder.
- C. One additional requirement is that it is necessary to program the "AUX" diode matrix as shown in Fig. 2...

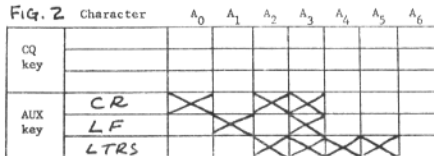

The "AUX" key is usually factory set to send DX when pressed and this is done using six 1N270 diodes. To program it for CR, LF, LTRS, you will need three additional diodes or a total of nine. With the aid of "solder wick" obtainable at any Radio Shack store it will be a simple matter to remove the diodes without damaging them. We refer you to Page 5-34, Para 5.13 of the manual on how to program the diode matrix. Read it carefully as the AO to A6 lines are in reverse to that shown on Fig. 2.

This mod relieves the operator of having to manually press the CR/LF keys at the end of

the line, however, you can still manually perform CR/LF at any time less than 64 characters by merely hitting the proper keys or the "AUX" key. Should you happen to be typing in the middle of a word at the 64 character count, the remainder of the word will appear on the next line less one letter which will be eliminated by the CR/LF signal.

Closing comments. We have installed both mods as above and we would not now be without them. It certainly allows for a much more relaxed approach to typing and we find that we can almost fill the 128 character buffer storage and we have never been able to do that previously in the course of a QSO, and this is without preloading the buffer. Also in the event of severe QSB or QRN or QRM conditions where many hits would normally occur the injection of the LTRS or FIGS between each character allows for better copy on the receiving end, a particular asset in a contest. While all of the above applies to the keyboard mentioned, there are a great many homebrew keyboards of solid state design presently in use to which the same principles would apply. Finally, our Thanks to DJ1XK and HB9AVK for sharing their expertise with us by allowing us to translate their efforts here.

LOOP SWITCHING

GARY BUDA, WA0NDN
301A 5621 Quebec Ave. N.
New Hope, MN. 55428

Here is a simple circuit that will allow you to increase the versatility of your station. I have always wanted to be able to switch various pieces of gear in and out of two different loops. I don't have the room for a 28ASR in the closet, nor can I afford one, but with this switching arrangement I have more than the versatility offered with an ASR without the cost or size.

There are two basic methods by which I can switch gear in and out of two different loops. One is to use a number of plugs and jacks in a "cord board" arrangement and the other is to use switches. Each have their own advantages and disadvantages.

Using a "cord board" arrangement is popular and simple, yet it offers some disadvantages. The wires and plugs must be in plain sight which detracts from the appearance of the station, the wires often get tangled, and Murphy requires the wires to break at the most critical of moments, and finally when switching a printer from one loop to another the machine runs open and when the current is reapplied there is a hit. This can be frustrating in the middle of a tape where errors are not wanted.

I wanted to be able to use switches since it is neater in appearance, there are no wires to get tangled or break, and the machine doesn't run open for the moment it takes to switch a printer in and out of loops. The biggest problem is to find a switch that will do the job without a great deal of overkill. There never seem to be enough in the junk box.

6 SEPTEMBER 1976

The switching arrangement eliminates the problems associated with a "cord board" arrangement. In the circuit the rheostats remain in the circuit since it is possible to remove all resistance out of one loop and blow a fuse. The gear can be switched entirely out of both loops by adding a shorting switch.

As I said, finding the proper switch seems to be the greatest obstacle to many. I have come across a supply of the switches and wafers. Most of them are new. They are \$1.25 for the wafers and \$3.00 for the entire switch, postpaid in the 48.

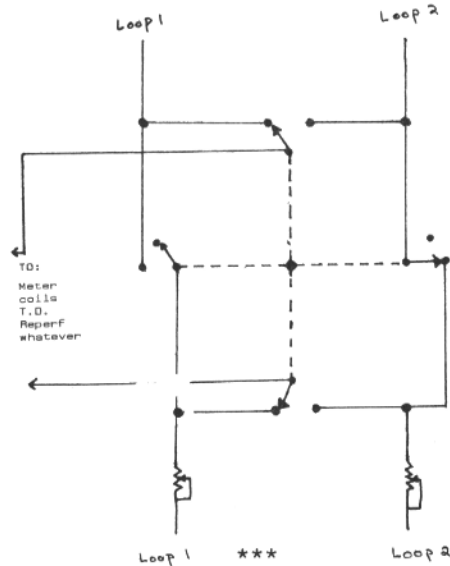

Mainline EC-1 and EC2 Error Corrector.

RON LIGHT, WB0NSR
1129 N. Geyer Rd.
KIRKWOOD, MO. 63122

Since the advent of the UT-4 there has been some discussion of how nice it would be to have some method of correcting typing errors. This is not as difficult as some may think and can be done with the use of a Fifo. This Fifo can be one that is external to the UT-4 or it can be one of the two existing Fifos in the UT-4. If one of the existing Fifos is used, the UT-4 system would then be cut down to a 40 character memory rather than its normal 80 characters.

The theory is relatively simple in that you type

and the characters are stored in this new Fifo. If the word is correct, you simply allow the word to leave the Fifo into the UT-4's main Fifos. If the word is not correct, the word storage Fifo would be reset and the word typed over again. The word Fifo would also have to be allowed to output on an end of line function as it would be too easy to erase this leaving the other fellow hung up on the old line.

The following two schematics are offered for experimental purposes only, as they have not been built up and debugged. It is suggested that you do not build either of these two up unless you are familiar with digital and debugging techniques. These schematics are offered hoping that someone will be able to produce a workable unit that may be shared with all. If time permitted, I would be able

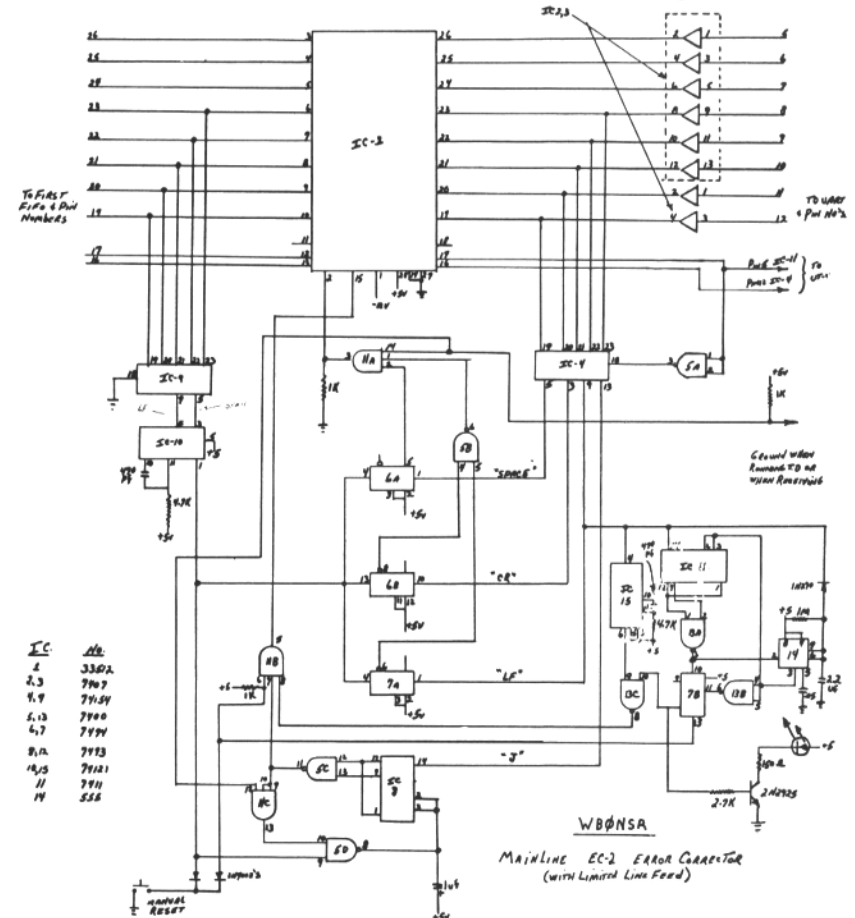

WB0NSR
Mainline EC-2 Error Corrector
(with Limited Line Feed)

to do this. But at present it is out of the question. However, I did want to get these schematics into the hands of the people most concerned and who had the available time. Good luck and good correcting.

**SHORT FORM CIRCUIT DESCRIPTION
(WITHOUT LINE FEED VERSION)**

IC-1 is the word Fifo, IC 2-3 are non-inverting buffers to provide fan out from the UART lines.

IC-4 is a 4-16 line decoder whose output lines will provide one half of the Baudot functions.

IC 5A is set up to inhibit this decoder during receive or when a T.D. is run. On transmit it serves as a deglitcher for IC-4. During code changes of IC-4, the possibility of an erroneous character producing a pulse on the output lines of the

decoder is extremely great during transition from one letter to another. IC 5a inhibits all outputs during this transition.

IC 9 is set up on a similar basis and its function is to recognize that the word has been fully outputted from the Fifo. Its outputs fire IC-10 which resets the Fifo to inhibit again.

IC 6 and 7a form the latches to enable the Fifo's output. They are set to enable from IC-4 and reset to inhibit from IC-9 and 10.

IC-8 and 5c form the erase function with IC-8 counting how many J's are sent, 5c recognizing 3 J's and pulsing the Fifo reset line. IC 5d resets the J counter to zero everytime three J's have been sent or whenever a word is outputted from the Fifo.

MAINLINE IC-1 ERROR CORRECTOR FOR UT-4
(WITHOUT LIMITED LINE FEED)

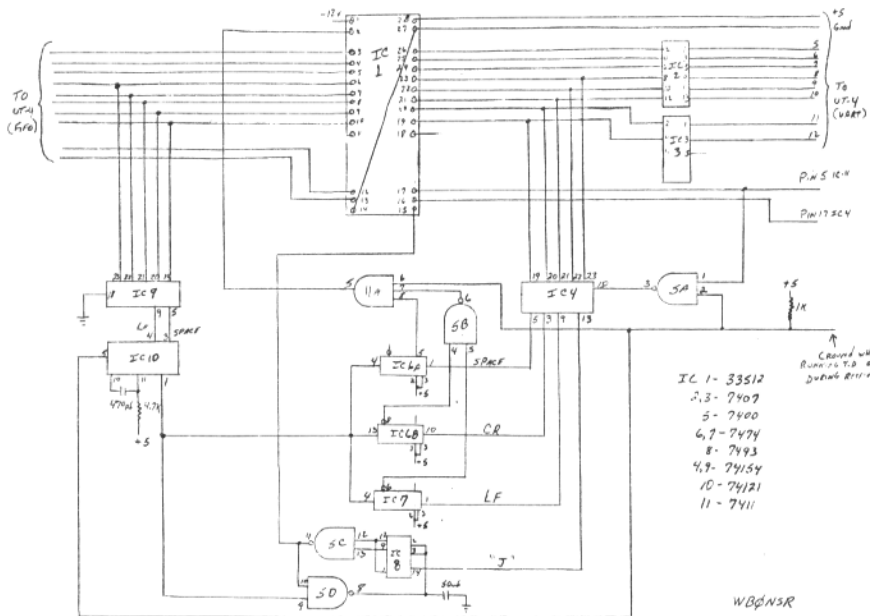

1 Finger Ltrs, Figures Return.

J. H. MCADAMS, K4GJW
2304 Dogwood Lane
Huntsville, AL. 35810

One of the most exasperating troubles with RTTY is for a machine to go to letters when it should print figures or vice versa. The down space on shift only half remedies the problem or maybe adds to it. I added on both the letters and figures keys, a simple switch to disable the term unit while actuating the appropriate character series in the machine transmitting loop thus forcing the machine back to upper or lower case as required. The added switch is adjusted to make contact

somewhat ahead of the mechanical release. The two switches are connected in parallel and to the remote or standby circuit of the TU. The switches are best made of spring steel or piano wire so that they are long enough and springy enough to prevent adding tension to the key. Only one spring is actually needed per key since the remote circuit ground can be completed thru the key lever arm. A simple plastic insulator bolted to the frame of the machine supports the fixed end of the spring. I have used this on Model 15 and 28 machines.

A few figures or letters are lost while the machine regains synch but it is better than many, as usual. Of course the system will act as the machine "mute" if pressed down until the switch only is operated.

VHF RTTY NEWS



Ron Guentzler, W8BBB, Editor
212 Grandview Blvd.
Ada, OH. 45810

The Double, G8CDW, 89, Linden Gardens, Enfield, Middlesex, England, sent word on the coming 8th BARTG VHF RTTY Contest. Although it is limited to amateurs in Zones 14 and 15 we thought it would be worthwhile to mention it here. The contest will take place on Saturday, 1976 SEP 11 from 1800-2300 GMT and on Sunday, SEP 19 from 0700-1200 GMT. Operation is permitted on both 144 MHz and 432 MHz. It is recommended that 45-Baud signalling speed be used. For further information, please contact G8CDW.

The following VHF RTTY information comes from Warren "Buck", Buchanan, WA0LEM, in Kansas City: "Effective 1976 JUL 04, the Kansas City Area went to 170 Hz shift (2125 Mark - 2295 Space). Most stations have 850-Hz shift capability, but all autostart and normal communications are 170 Hz. The WR0AHR repeater, 146.100 MHz in, 146.700 MHz out, is voice and RTTY accessible. All mobile operators in the area are invited to call and 'talk' RTTY while in the area, as several of the stations monitor for voice calls." Thanks, Buck.

Melvin Leibowitz, W3KET, has the following news that shows how versatile hams are becoming: "We have a new repeater in the Wilmington, DE, area that is especially intended for special purpose uses such as RTTY, SLO-SCAN, and Fax. The call is WR3ACV and the frequencies are 147.825 MHz in, 147.225 MHz out. Narrow shift RTTY is used. Power output is 40 watts which will be increased to 120 watts. The repeater is jointly owned and operated by WA3QPX and WA3QLS. The antennas are only 80 feet above sea level, but experience with the site indicates that we should have coverage well into the New York City Area. Antennas consist of a Phelps-Dodge Station Master plus two rotatable beams. Primary coverage will be NE-SW from Wilmington thus putting our main pattern to Philadelphia and New York and to the Baltimore and Washington areas. We do have two stations on 24-hour autoprint. Operators along the East Coast are invited to listen for the machine. The owners feel that this is a unique machine in that it is one of the first high-powered special purpose repeaters. Activity is needed and all operators are invited to use the machine."

Finally, we have a current-awareness item: John Sheetz, K2AGI, has the following article in the 1976 AUG issue of QST, pp. 32-33: "Rid Your Model 28 TD of Distortion." The history behind the article is quite interesting. As we

understand it, it came about when John monitored an on the air signal which was full of distortion.

Well, that's it for this month. Please keep the information coming.

73, ES CUL, RG.

Noise from a Governed Motor.

I had one problem that I thought you might like to hear about. I have a model 15 machine and it has a series governed motor. This motor generates a lot of noise. It was almost half scale on the receiver! In checking with some local experts I tried using an SCR to control the motor current instead of switching the full load with the governor contacts. Low and behold, it worked. I now have almost no noise from the motor. This is a lot easier than putting a synchronous motor in.

Glen Charnock WB6JKM
560 W. Gonzales Rd. #22
Oxnard, Ca. 93030

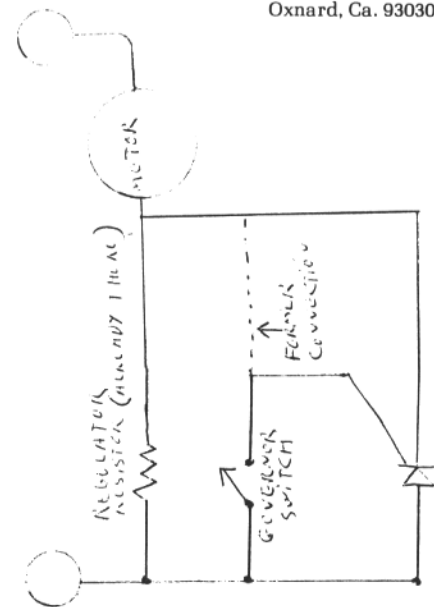

RTTY-DX

John Possehl, W3KV, Editor

P.O. Box 73, Blue Bell, PA 19422

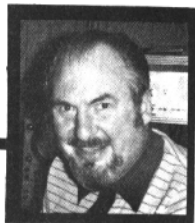

Hello there . . .

As the saying goes, "after the Boom comes the Bust", and the tremendous DX activity of early Summer has settled down to the normal routine with new countries few and far between. Also, one might well ask the question; where did everybody go? A few short weeks ago the boys were burning the midnight oil looking for stations like JY4JW, FL8KW, 9B5AN, ZD8PL, ZD8RD, 5B4YK, 5Z4TV, TA2MM, 8P6AY, 8P6HE, 8P6GC, TG9AD, TG9GI, P2 9DJ, P2 9MO, and many more. To be sure, they are all for real as we have had QSL cards pass through here for all of them but JY4JW and 5Z4TV for DXCC credit. As usual of course band conditions were a contributing factor to the decline as they have been in quite poor shape for several weeks. However, there were some rewards for those that kept their printers clacking. Early June brought RTTY activity for the first time from a really rare spot, Malaysia. Mal. 9M2MW, fired up and has been logged by many of the boys in Japan and adjacent areas. He has even penetrated to West coast USA but so far has not crossed the Rockies in North America or for that matter into western Europe. We have been advised by Gin that Mal has a linear and a beam in the works so he should be copy into most all areas, soon, conditions permitting. Dusty informs us that he has subscribed to the Journal so that may mean that he intends to stay with the mode for a while. Two more stations may soon come up there also, 9M2CL and 9M2ML and we hope to keep you advised as things develop.

Sid was quite active from his home call of G4CTQ while on a few weeks leave in the U.K. He returned to A4XGB in Oman in late June and hopes that he can persuade the authorities to lift the present ban on RTTY. Watch for Sid at any time now.

Early June saw a rare appearance by Sigge, OH /NI, from Aland Island.

P29MO has been reported quite active and Graham, P2 9DJ is very prompt in sending out his QSL.

With some able assistance from Dick, WA3JTC/ZP5, both ZP5XT, and ZP6AT were quite active early in the summer and you can QSL to them either direct or via Dick.

A real surprise in mid July was the excellent signal from JY9BB in Amman. Blackie was trying out his new Hal video and solid state keyboard and it sure was doing a great job for him. W9OEQ was his first contact stateside and QSL's are requested via his stateside QTH at W4TA, and that is . . .

Bruce Blackburn
9001 Old Courthouse Rd. N.E.
Vienna, Virginia 22180

10 SEPTEMBER 1976

5B4BK on Cyprus was reported active the same day using 45 band and 850 hz shift, Peter, 5B4YK, is now QRT and has returned to Finland. Any QSL's sent now should go to his home call which is OH2BCA.

Unfortunately this info arrived here too late for the last issue and is over by the time you read about it here. Pierre, F2PY, made his annual trip to Andorra as C3 1CA where he was active between 2 and 7 of August. If you were fortunate to have made contact he requests QSL's be sent to his home QTH . . .

Pierre Pollidoro, F2PY
82 Montpezat - DU - Quercy
France

Those trying for WAS might listen for KL7HAQ who has been active this Summer.

Cz 2 O was the official Olympic station operating from the site of the Games in Montreal. QSL cards were requested via the VE2QSL bureau.

Roy, PJ3AR, has been back home now for several weeks and expresses regret that he was unable to operate RTTY from PJ7/FS7 during his six week stay on the island. All is not lost, however, as Roy will be moving to there permanently around October or November. He has already applied for the call sign FS7RR. Once he is settled at his new QTH he assures us that RTTY will soon follow.

ZD8EW has been reported active from Ascension so it would seem that a high percentage of the active amateurs on the island are going RTTY.

RTTY activity from North Ireland has always been quite difficult to find. GI4AMP has now been joined by GI3GXP who has been putting an excellent signal into the States. From the Republic of Ireland your best bet is still Paul, EI5BH, who seems to be the only active station on the HF bands at present. He can usually be found at around 12-1300z daily.

The last listing of the Honor Roll had W8JIN in the No. 1 spot with 97 countries confirmed. A few days after publication the mail brought 101 QSL cards confirming . . .

Plaque Nr. 23 for 100 RTTY DXCC
TO

Jim Ringland W8JIN

Jim was first licensed in 1933 at age 15 and has held W8JIN the entire time. A 40 Meter QSO with a CT2 in 1934 gave him the DX fever from which he has never really recovered. Regular DXCC was first made in 1947 and he now has the very difficult 5 Band DXCC Award. Over 100 countries have been confirmed on all bands, 10 thru 80 on both fone and CW with 50 countries confirmed on 160 meters. Jim collects Awards like most of us collect QSL's and he was first in the World to

receive the Arne Trossman Trophy for his collection of over 200 Awards. Jim is presently hot after DXCC via Oscar but you are sure to find him in the middle of the pile-up when a new one shows up on RTTY. When not chasing DX Jim is the man responsible for the big TV signal coming out of Channel 12 in Cincinnati, Ohio.

Congratulations are extended to the following amateur . . .

W A C A L 14 MHZ
Nr. 31 Angelo Lo Re 1PYS

At the time Dusty authorized the issuance of a DXCC Award for RTTY it was decided that the basis for country count would be the ARRL DXCC Countries list. The ARRL publication covering the subject in detail is called "Operating Aid Nr. 7" and can be obtained upon request by sending either a SASE or 2 IRC's (for DX) to ARRL Headquarters. From time to time changes in the existing country count are revised due to either political or geographical considerations and the list that you had last year could very well be obsolete this year. As anyone having an insurance policy knows, it is the "fine print" that contains all the important information and Operating Aid Nr. 7 is no exception in this respect. Reading the fine print in the foot notes could get you a couple of additional countries. We will try to bring you up to date on some of the important revisions and perhaps answer some of the questions most frequently asked.

DELETED COUNTRIES

Germany — DA, DJ, DK, DL, DM — Only contacts made BEFORE 17 Sept. 1973 will count.

Ryukyu Is. — KR6, 8, JR6, KA6 — Only contacts made BEFORE 15 May 1972 will count. After 15 May counts same as Japan.

Papua Territory — P2, VK9AA-MZ — Only contacts made BEFORE 16 Sept. 1975 will count.

New Guinea Terr. — P2, VK9AA-MZ — Only contacts made BEFORE 16 Sept. 1975 will count.

Swan Island — KS4 — Only contacts made BEFORE 1 Sept. 1972 will count. Sept. 1 and after counts same as Honduras (HR6).

Newfoundland, Labrador — VO — Only contacts made BEFORE 1 April 1949 will count. After 1 April counts same as Canada.

CURRENT COUNTRIES

Fed. Rep. Germany — DA, DJ, DK, DL — Contacts 17 Sept. 1973 and after will count.

Dem. Rep. Germany — DM, DT — Contacts 17 Sept. 1973 and after will count.

Papua New Guinea — P2 — Contacts 16 Sept. 1975 and after will count.

So what does it all mean? We will try (!?) to make it clear with a few examples that apply to the RTTY mode.

1. If you had a QSO with DK3CU and DM2AYO before 17 Sept. 1973 it counts (1) one country for DXCC.
2. If you had a QSO with DK3CU and DM2AYO on 17 Sept. 1973 or after it counts as (2) two countries for DXCC.
3. Total countries equals (3) for DXCC.

Another example —

1. If you had a QSO with VK9GG and VK9MC before 16 Sept. 1975 it counts as (2) two countries for DXCC.
2. If you had a QSO with P29DJ 16 Sept. 1975 or after it counts as (1) one country.
3. Total countries equals (3) for DXCC.

We hope that all of the above will help to put your totals slightly and perhaps in some cases to put you over the top.

The SARTG Contest is about over now and hope we can have a report next month. Coming up real soon is the CARTG "Olympics 21 SS", 2-4 October. Log sheets and Zone matrix available from CARTG. Send SASE or IRC's.

73 de John

DXCC Certificate from ARRL.

We have just received word that the ARRL has decided to offer a DXCC certificate with RTTY endorsement. Details are not known but should be available by listening to W1AW, or in a near future issue of QST. As soon as we get all details John will have the rules in his DX column. The JOURNAL will continue to offer a plaque and endorsements as in the past for DXCC. NO charge for the Plaque.

FURTHER DETAILS--

The ARRL will issue a DXCC Certificate endorsed for RTTY one a once only basis (no further endorsements will be entered). Send only 100 cards with maybe an extra in case of disqualification of a card.

Cards will be accepted on November 1st 1976, and cards received before that date will be set aside and not processed until a later date.

There is no charge for the certificate but postage for return of cards must be enclosed. \$1.00 if you have a street address via United Parcel. If only a box number \$4.00 for registered mail . . .



From The Editor
and
his Mail

After a reprint of 500 copies of the UART articles, and then receiving a number more from Clyde Keenan we thought we would never use them up. We were wrong! We are completely out of them but still get requests. If someone really needs a copy, we have made arrangements with R. Wilson, WBØESF, 4011 Clearview Ave., Cedar Falls, IA 50613, to supply them on an individual basis for \$2.00 a set postpaid. There are 12 8½ x 11 pages containing all 4 UART articles. We sent Red our last copy to use as master so have only the original articles in our Journal File. Red also does a good job on duplicating any past issue of the Journal. The duplicates are done on both sides of the paper and except for some halftone reproductions, are hard to tell from the original. \$1.00 per issue, pp. We mention this as a service to readers looking for back issues as there are very few we can supply.

The Dayton Hamvention is April 29-30 and May 1st next year. The RTTY JOURNAL room will be at the same spot. Kings Room, at the IMPERIAL NORTH MOTEL. If this seems like a long time ahead, we mention it in case you wish to reserve a room at that motel. It is always sold out completely months ahead. We suggest you send a \$25 deposit - name - number of nights a room is wanted and how many in the room - NOW. Deposits will be returned if you cannot use the room. Imperial North Motel - 175 and Needmore Rd., Dayton, OH.

Most readers are probably aware of the changes in allowable power in the novice bands - Limit of 250 watts, regardless of license. Since there has been some RTTY action about 7140 in the past, and this is in the novice band, watch your power if operating around this frequency. 7040 and 7090 are other frequencies used but very seldom do we hear any RTTY on this except during contests.

If "gh" stands for "p" as in "hiccough"; "ough" for "o" as in "dough"; "pht" for "t" as in "phthisis"; "eigh" for "a" as in "neighbor"; "tte" for "t" as in "gazette"; and "eau" for "o" as in "beau" - the correct spelling of "potato" must be - "ghoughphttheighteeau".

That looks like some of the copy at times received on the teletype paper especially during a RTTY Contest!

"C.A.R.T.G."

Beginners RTTY Handbook.

Price \$2.50 pp.

RTTY JOURNAL

PO Box 837

Royal Oak, MI. 48068

BACK ISSUES -

New subscriptions and classified ads are cash in advance as we have no method for billing. New subscriptions will be started with the current issue and one back issue, if requested. Please do not ask us to start any further back than this. Back issues - if available - may be ordered at 35 cents each at time of subscription. The JOURNAL is mailed about the 20th of the month preceding the dated month. May and June are a combined issue and July-August is a combined issue.

The ONLY back issues available are listed below. 35 cents each.

1972-Oct.-Nov.-Dec. - [3]
1973-Jan.-Feb.-Mar.-April.-
May.-Jul.-Sept.-Nov. [8]
1976.-Feb.-Apr.-May.-Jul. - [4]

Subscription Rates

RTTY JOURNAL

Editor & Publisher "Dusty" Dunn, W8CC

Box 837- Royal Oak, MI 48068

U.S. Canada, Mexico, 1st Class \$3.50

Canada, Mexico, Air Mail 4.00

Surface Mail 4.00

Other Countries - Air Mail 8.00

CLASSIFIED ADS-- 30 words \$2. Additional words 4¢ ea.

Cash with copy, Deadline 1st of Month.

MORE RTTY! ONLY HAM RADIO MAGAZINE consistently brings you more RTTY articles and better RTTY articles than any other general amateur magazine. You need RTTY Journal, but you need HAM RADIO also. \$10.00 per year, \$20.00 for 3 years. Ham Radio, Greenville, NH 03048.

HAL COMMUNICATIONS CORP. Headquarters for electronic RTTY equipment. In demodulators, choose from the incomparable ST-6 or, for a low cost beginning in RTTY, the ST-5. Tailor either to your requirements by selecting the 425 Hz press discriminator, the XTK-100 or AK-1 AFSK oscillators and the ST-5AS autostart for the ST-5. Full details available in our current catalog. Compare before you buy. BankAmericard and Master Charge plans available. HAL COMMUNICATIONS CORP., Box 365RJ, Urbana, Illinois 61801. Phone 217-367-7373.

QSL CARDS - Double Style, forward info, then recipient acknowledges on lower half. For contests or any use. Use singly also. Write or stamp your call, etc., on forms 100/\$5.00 post-paid. D T Printing - RJ, 390 Lincoln Ave., Newark, N.J. 07104

TELEPRINTER GEARS, COMPONENTS, Modification kits, tools, manuals, parts, ribbons, supplies, paper. Toroids SASE for list AB. Typetronics, Box 8873, Ft. Lauderdale FL 33310. We buy all unused parts and late unused machines.

DOVETRON MPC-1000R (E Series) REGENERATIVE RTTY TERMINAL UNIT retains all the features of the MPC-1000/MPC-1000C Terminal Units plus the benefits of the TSR-100 Teleprinter Speed Converter-Regenerator. Front panel controls permit signal speed selection (60, 67, 75, 100 WPM Baudot and 110 Baud ASCII), Memory Functions (Unload, Reset, Preload and Recirculate), and Character Rate Over-ride. Two front panel LEDs indicate the status of the Memory Section (Full or Empty) and the state of the TD inhibit line. The latter is controlled by a unique automatic memory unload circuit that prevents character over-runs even when pulling tape. The BLANK diddle character is generated by the tri-state mode of the UART regenerator and prevents a signal time-delay or first character error on the outputted signal. MPC-1000R: Commercial: \$995.00. Amateur: \$745.00. Shipping and Insurance: \$9.50 Continental USA. Delivery: 30 days ARO. DOVETRON, 627 Fremont Avenue, South Pasadena, California, 91030. 213-682-3705.

MINI-MANUALS ON FOLLOWING EQUIPMENT, \$2.95 each - M15/19 Wiring Hints and Diagrams. CV-89/URA-8 FSK Converter. IDA-2 Stelma Teletype Distortion Analyzer. AN/SGC-1 FSK Converter. Teletype Gear Guide for all Teletype Corp. equipment. SASE for surplus list. Jim Cooper W2BVE, POB 73, Paramus, NJ 07652.

HAL COMMUNICATIONS CORP. announces the DS-3000 and DS-4000 series of KSR Video Display Terminals for Baudot and/or ASCII code. Offering error correction capability, multi-speed operation, and 16 lines of 72 characters per line, these terminals employ the 8080 microprocessor in what we believe is the first microprocessor based product offered to the amateur radio communications market. Request data sheet for full information. HAL COMMUNICATIONS CORP., Box 365RJ, Urbana, IL 61801. Phone 217-367-7373.

RTTY OPERATORS: HAVE MINIATURE TELEPRINTERS & other teletype equipment. Call Al at 416-266-2623 after 8 P.M. or send SASE to Mills, Box 851, Stn A, Scarboro, Ontario, Canada.

NEWS-NEWS-NEWS-Amateur Radio's Newspaper, "Worldradio", Trial subscription - Two issues for one dollar. "Worldradio" 2509-F Donner Way, Sacramento, Calif. 95818

WANTED: 28-ASR Teletype Terminal, 100-WPM, with Bell 83B3 Stunt-Box and CE-10-034 Polling Assembly. Will pick up within 200 miles. Dealer inquiries invited. M. Bardfield, W1UQ, 879 Beacon St., Boston, Mass. 02215

HAL COMMUNICATIONS CORP. announces the ST-6000 RTTY Demodulator/Keyer. The ST-6000 is ideally suited for amateur or commercial service offering fixed 850, 425, and 170 Hz shifts for ease of tuning. Standard low and high tone frequency pairs are available, and active filter design allows the use of any set of tone pairs between 1200-3000 Hz. Crystal controlled tone keyer for stability. Self-contained loop supply RS-232C, and MIL-188-C levels for I/O. Scope or meter tuning. Keyboard operated switch. Selectable ATC, and new DTH (decision threshold hysteresis) circuitry allows optimum performance under the most demanding conditions. Complete flexibility in the inter-connection of the demodulator and tone keyer allows separate, half duplex, or full duplex operation. Usable at all data rates up to 110 baud ASCII in standard form. The ST-6000 carries the usual HAL one-year warranty, and is an ideal companion to our new DS-3000 KSR microprocessor based communications terminal. Write today for full details. HAL Communications Corp., Box 365RJ, Urbana, Ill. 61801. Phone 217-367-7373.

AUTOMATIC CW ID UNITS. Programs up to 32 dots, dashes, or spaces, easily programmed. All on one board. Less supply, kit \$12.95; wired and tested \$17.95 (your call must be supplied). Interface for above for ST5 or ST6, AFSK or FSK, Kit \$4.50, wired and tested \$5.50. 10 minute automatic resettable timer for ID unit, kit \$8.95, wired and tested \$11.95. 5V 1A fully regulated, short proof TTL supply, with transformer and plug in or hard wired board, kit \$12.69, wired and tested \$16.69. SAVE on all four units, package of above reg. \$39.09, kits sale price \$35.95. Reg. wired & tested price \$51.09, sale price \$47.00. Cabinet for above, unpunched (dozy E box) \$7.25 each. NuData Electronics, 104 N. Emerson St., Mt. Prospect, IL 60056.

0A-5 SOLID STATE TU includes autostart and AFSK oscillator. See February and September 1974 issues of "RTTY Journal". Drilled and plated boards, \$15.00; board with parts, \$110.00; completed unit, \$225.00 FOB. Ken Simpson, WA8ETX, 3700 Mountview, Alliance, Ohio 44601.

HAVE FULL SET OF RTTY JOURNALS, Will duplicate any issue \$1.00 PP. Also duplicate of all 4 UART articles with large drawings. \$2.00 PP. U.S., Canada, Mexico. Other countries 25 cents extra. R. Wilson, WBØESF, 4011 Clearview Dr., Cedar Falls, IA. 50613.

THRU-HOLE PLATED UT-4 PC BOARDS - Commercially made. Set of four thru-hole plated, solder coated, G-10 epoxy glass boards. 2-7/8" X 7" with provisions for 12 pin edge connectors. Boards include XB-6 Dual Clock, Two UT-4 boards, and power supply board including plus 5 volts, minus 12 volts, and plus 12 volts. All boards two sided with the exception of the power supply. Boards ready for immediate shipment. \$22.50. Postpaid in U.S. Clyde Keenan K7WTQ, Rte. 1 Box 309, Lakebay, Washington, 98349 1-206-884-3838

**Additional Classified
See Next Page -**

FRIDEN SFD FLEXOWRITER has 8 level tape punch and reader. Connector for remote typing, etc. Types capital alphabet, numerals, symbols. Mechanically excellent. \$125 crated. Friden STRA-SD paper tape reader. Reads or searches for control character on 8 level paper tape. Table top cabinet with its own motor, etc. Complete, but may require minor adjustment. \$25 boxed for shipping. Teletype LRB 201AB 8 level paper tape punch. Serial input. Self contained in table top cabinet. 125 boxed for shipping. Good shape. Teletype KSR-15 in large floor cabinet. Good shape. \$100 carted. Teletype KSR-15 bare — no cabinet. Mechanically like new. \$75 crated. DURA MACH 10 — an IBM Selectric type and keyboard and 8 level paper tape punch and reader all in one office style typewriter case. Recently tuned up by IBM trained serviceman. These are used as computer 1/0. \$300 crated. All items plus shipping. L. Lawler, 3101 Justin Way, Concord, CA 94520. (415) 689-1655 evenings.

TELETYPE: WANT M32/M33 teleprinters — complete or incomplete. Good prices paid for your old and used equipment. Will buy "as is". Bruher Teletype Service, P.O. Box 247, Dumont, N.J. 97628.

TELETYPE MODEL 28ASR \$600 automatic carriage return and line feed, gear shift 60-66-100 WPM, answerback.

Teletype 28KSR — Auto carriage return and line feed \$250. Teletype Model 28 Typing reperfector, gear shift 60-75-100 WPM — \$150. Both 28ASR and reperf for \$650. Both 28KSR and reperf \$200. KWS-1 and 75A3 with product detector both \$500 good operating condition. Frank C. White, W3PYW, 2706 Harmon Road, Silver Spring, Maryland 20902. (301) 933-2257.

MODEL 28 ASR's — KSR's, Repurfs - Keyboards, TD's - Printers, Parts - All priced for Hams. All in excellent condition. A.D.M. Communications, Inc., 1322 Industrial Avenue, Escondido, Ca. 92025. (714) 747-0374

SALE: MODEL 28 LPR RECEIVE ONLY Typing Reperf. On stand alone base complete with 3 speed gear shift (60-75-100). AC Syn Motor, and cover. Good condition \$165; Model 28 LXD Transmitter Distributor, stand alone type, complete with AC Syn Motor and cover. Good condition \$125.00; Model 28 RO Base complete with 115 V AC Syn motor, and intermediate gear assembly. Good condition \$69.00; Model 28 RO Table Top Cover, Good condition \$39.00; Model 28 LP Stuntbox Mark 111 with stunt bars still in place, \$24.00; LPW paper winder 300, Good Condition \$39.00; Model 28ASR machines complete with Reperferator and T.D. \$495.00. Other machines available so let us know what you need. WE ALSO BUY MACHINES, PARTS, MANUALS: ATLANTIC SURPLUS SALES, 3730 Nautilus Ave., Brooklyn, New York, 11224. Tel.: (212) 372-0349.

HAL COMMUNICATIONS CORP. announces the MCEM-8080 microcomputer. The MCEM-8080 is a complete operating system on a single PC board, including serial I/O at RS-232C levels or 20-60 ma current loop, 3 parallel I/O ports, 1024 bytes of RAM, 1024 bytes of ROM containing the system monitor program, and switches and indicators to manually control all bus and control lines. The powerful 8080A CPU and its family of chips are used. The system monitor allows the use of either Baudot or ASCII terminals, and enables the user to load hex files, dump or display memory, insert data in memory and transfer program control to a specific location. Whether you are a RTTY operator turned computer hobbyist, or a computer hobbyist turning to RTTY for a communications link, the MCEM-8080 should be your choice. Write today for full details. HAL Communications Corp., Box 365RJ, Urbana, Ill. 61801. Phone 217-367-7373.

ST-5's WITH AUTO-START. AK-1 and manuals. HAL kits, ready-to-run in lettered cabinet. \$185 or \$25, balance UPS COD. David Tancig, 618 W. White St., Champaign, IL 61820

RTTY PICTURE PERF TAPES: Over 575 different available. Special of the month; includes 10 different, 5 hours 28 minutes running time of nudes, \$10.00. Send for free catalog to: Al Perkins, 217 Cedar St., Galesburg, IL. 61401

UT-4 COMPONENTS. Still stocked in depth. UART's \$7.00, FIFO's \$14.00, each. MC3408L D/A \$4.50. All postpaid. Others, see July-August ad. Peter Bertelli, W6KS, 5262 Yost Place, San Diego, CA 92109. (714) 274-7066.

MODEL 28 TELETYPE MOTORS, 1/12 & 1/20 HP. Approx. 700, as removed from service. Gordon, 1334 Lake, Chicago, IL 60607. (312) 421-5940

HAL-DKB 2010 DUAL MODE KEYBOARD — excellent condition, with instruction manual. Make offer — asking \$300. Bob Doersam, W8OEM, 2745 Bristol Road, Columbus, OH 43221. (614) 457-2797.

MODEL 28 KSR, Newly cleaned-adjusted floor model, \$200; Model 19, complete. Auto car/line feed-table, \$80; Model 14 typing reperf complete. Original wood case. Like new condition, \$40; Model 19 without TD-w/old metal. Table partially rewired, \$50; Model 15, good working condition w/metal table, \$40; Model 15 w/wooden table - good machine, keyboard rough, \$25; 15 Keyboard - mechanical WRU, \$10; SB30-SB400, \$400; Northern TU scope & meter, \$50; CV 89/URA-8A-TU, \$50; 7 ft. Rack with roller base - hvy duty, \$30; Misc. bases - typing units, etc. For parts. Write: C. W. Prindle, W6J0X, 401 Carrillo St., Santa Rosa, CA. 95401

DOVETRON TSR-100 TELEPRINTER SPEED CONVERTER-REGENERATOR is a 6" by 7" PC card designed to mount inside of any MPC Series Terminal Unit and is intended to provide signal regeneration and UP-DOWN speed conversion. The 18 socket-mounted CMOS devices include a Uart, two FIFO Ripple Memories (80 characters), a programmable crystal-controlled Dual-Clock, and a bilateral steering section that permits solid-state switching between Transmit and Receive. All Uart functions including Parity are switch-selectable. Both sections of the Dual-Clock are programmable for 60, 67, 75, 100 WPM Baudot and 110 Baud ASCII codes. All 8 parallel data lines are available at the output of the Memory section. The TSR-100 also offers Variable Character Rate, BLANK Diddle and memory functions of Preload, Recirculate and Reset. The BLANK Diddle is Uart-generated (Tri-state mode) and does not contribute time delay or first character errors. A unique Memory Unload circuit prevents character over-runs and provides a TD Inhibit. A pair of LEDs indicate Memory status. All signal input and output ports are fully buffered for easy interface to other terminal units. Power requirements: +5/+15 volts at 85 mls and -12/-15 volts at 10 mls. TSR-100: \$195.00. POSTPAID Continental USA. Delivery: 30 days or less. DOVETRON, 627 Fremont Avenue, South Pasadena, California, 91030. 213-682-3705.

SALE: BLACK NYLON RIBBONS for all your Teletype machines; Box of 12 for \$5.90; Red and Black nylon ribbons, Box of 12 for \$9.75; Ribbon Re-Inkers for your Model 14, 15, 19 and Kleinschmidt machines; Print nice and dark and stop straining your eyes for only \$3.90 a Kit. (Specify for which machine.) White Roll paper for \$2.25 per Roll. Toroids, 88 millihenry, center tapped, never potted, 5 for \$4.00; Female jack panels containing 144 jacks on a 19" panel \$16.00; Female jack panel containing 24 jacks, Fannestock type 218A on a 19 inch panel \$6.50. Also available Machines, Parts, and Supplies. Write stating your needs. Atlantic Surplus Sales 3730 Nautilus Ave., Brooklyn, New York 11224. Tel: (212) 372-0349.

PC BOARDS FOR THE UT-4, double sided, thru-hole plated, plug-in edge connectors. Write for details. AK-2 kit for \$19.95. XK-2 XTAL AFSK kit \$34.95. ELECTRONIC DEVELOPMENT, INC. P.O. BOX 951, SALEM, OREGON 97308, (503) 399-9660.

SELL: Viking Ranger II Xmttr 160-6 meters \$150; FRXD-20 with climbing TD head \$75; TS-969/U Dual Stroboscope \$90; Scope Cart \$25; BC-221 with modulation and PS \$35; SRR-13A general coverage receiver 2-32 MH AM, CW, SSB, FSK \$115; CV-60 TU\$75; CV-89 TU \$75; HP-606A \$650; URM-25 \$150; TS-505D \$40; R-390 \$300; R-390A \$350; R-1052/FRR general coverage receiver 30-60 MH/60-260 MH AM, FM, CW \$450; Collins CV-157 \$250; Collins 32-RS-1C SSB Transceiver \$275; Watkins-Johnson VHF Receiver Model 441-3-21 \$50; New 28-ASR Cable/connector set #158264 \$40; TMC Vox-3 \$75; Eldico R-100 2-32 MH Xtal-Controlled Receiver \$100; TS-659 \$50; DAC-6A \$600; TS-1920A \$35; TS-1618 \$75; RAK-6 \$30; HP-417A \$65; Hallicrafters SP-44 Panadapter \$25; O-203A Xtal Synthesizer 200-40 MH \$125; WU 6-Level Stock Ticker \$100; USM-116A VTVM \$100; ALL PICKUP ONLY SAN DIEGO/LOS ANGELES AREA, W6CRG 11007 Explorer Road, La Mesa, California 92041

FIVE MODEL 35 (8 LEVEL) Narrow tape (3/8") Printers with model 35 ASCII Keyboard complete except for motor. Takes standard 35 or 28 type motor. Can be converted to model 35 (8 level) reperf. Model 28KSR, excellent condition, rewired ready to plug in, \$300.00 Model 28ASR including TD and perf, excellent condition, rewired ready to plug in \$400.00. Model 28LBD stand alone TD including cover, rewired and ready to plug in \$100.00. Bill Parker, 984 Amelia Ave., Akron, OH, 44302.

NS-1A PLL TU (Journal 1/76 Ham Radio 8/76) Wired/tested \$29.95 ppd. Board \$4.75 ppd. Parts only \$15.00 ppd. SASE for info. Nat Stinnette Electronics, Tavares, FL, 32778

TELETYPE MACHINES, SERVICE, PARTS. Large selection of 5 level equipment. Write about your needs. SASE for equipment list. P.A. Anderson, 2448 N. Wilson, Royal Oak, MI. 48073. (313) 398-5922.

\$85.00 WILL BUY A 4" x 6" x 2", solid state, self-contained 30 mhz/khz readout. Dick Arthur, 5343 West Earll, Phoenix, AZ, 85031. (602) 247-8866.

MODEL 28 ASR's \$600.00 ea. excellent condition. Write or call A.D.M. Communications, Inc., 1322 Industrial Ave., Escondido, Ca. 92025, 714-747-0374.

TECH MANUALS - \$6.50 each: TT-63A/FGC, CV-591A/URR, TS-2/TG; following manuals \$8.50 each: R-388/URR, TH-5/TG, USM-50; other manuals - TGC-14/14A, \$12.50, TD-298A/B, TT-299A/B, UGC-38, 40, 41 - \$15.00. Model 14 TD manuals, \$3.00 each. All manuals mostly new, unused. Thousands more in stock. Send 50 cents (coin) for large 22-page listing. W3IHD, 7218 Roanne Drive, Washington, D.C. 20021.

YOUR COMPUTER IMAGE (10 x 12): Have your favorite full head photo printed by our computer system for only \$4.00 per picture. (\$2.00 for each additional copy.) Send your photo to - The Computer Hut, 7702 Richmond Hwy., Alexandria, VA, 22306 -- Only full head photos are acceptable.

HAL COMMUNICATIONS CORP: Announces PRICE REDUCTIONS on the proven RVD-1005 Video Display unit, and the DKB-2010 Dual Mode Keyboard. You'll have a quiet, reliable, system allowing you to transmit and display BAUDOT Code at all our standard speeds, and at a very attractive price. Write or call for full details. HAL COMMUNICATIONS CORP., Box 365 RJ, Urbana, Illinois 61801. Phone 217-367-7373.

MODEL 19 TELETYPE, \$150.00. Model 14 Typing reperf \$50.00. Converter, W2PAT type, \$25.00. All in very good condition. Shipping not included. Hank Hunt, W10RI, 6 Pine Tree Lane, Glastonbury, CN. 06033. (203) 633-2723.

MODEL 28 KSR's - \$145, ASR's - \$395, Loads of 15's and 19's - \$25 - up. Crating and shipping available. C.B. Goodman Co., 5454 South Shore Dr., Chicago, IL 60615. Phone anytime/312-752-1000.

SPECIAL SUMMER TELETYPE PAPER SALE for RTTY JOURNAL readers only! Just one year ago we first advertised in RTTY JOURNAL and your response has been fantastic! To show our appreciation, we have set aside a special lot of 50 cases of our regular white 4 1/2" diameter TELETYPE paper at a special price for R/J readers only. A case of 12 rolls for only \$15! Offer good for this month only or until special stock is gone. Stock up now for winter! ZTY-RTTY PAPER CO. PO BOX 147, CORUNNA, MI 48117

DOVETRON MPC-1000 (E Series) MULTIPATH-DIVERSITY RTTY TERMINAL UNIT. The new E Series represents the sixth generation and adds Automatic CRT Intensity Control, Keyboard Actuated Autostart, Automatic Threshold Control for unattended operation, Fast-Slow Autostart, and Autostart Delayed-Timeout to the MPC's MULTIPATH CORRECTOR, IN-BAND DIVERSITY MODES, and the continuously variable Mark and Space channels. All IC's, transistors and CMOS logic elements are mounted in low-profile sockets for ease of servicing and maintenance. Interfacing to the TSR-100 or UT-4 speed converter/regenerator is accomplished by removing two jumpers at the rear panel. Your QSL brings full specifications. MPC-1000 (Amateur) \$495.00. MPC-1000C (Commercial) \$795.00. Shipping and Insurance: \$7.50 Continental USA. Delivery: 30 days or less. DOVETRON, 627 Fremont Avenue, South Pasadena, California, 91030, 213-682-3705.

MODEL 28 KSR'S, FRICTION-FEED X'telco units in good condition, crated ready for shipment. Quantities available. \$200 each FOB N.H. Satrak Telemetering, Martin Geisler WA6TIC, 11300 Hartland St., North Hollywood, CA 91605.

HAL COMMUNICATIONS CORP. will display the line of RTTY and microcomputer equipment at the New England ARRL Convention (Boston), Radio Expo 76 (Chicago), Cincinnati, Peoria, Illinois, and Findlay, Ohio. See you at the show.

RTTY PICTURE PERF TAPES. Hundreds, including nudes, cartoons, animals, works of art, landscapes, all of the RTTY Art Contests entries. Chad type (fully punched, no lids) 11/16 inch standard Amateur 5-level paper tape. Guaranteed COMPLETELY error-free. Run times from 2 minutes to 10 hours. Listing and info free if request typed on 5-level printer, otherwise send 24 cents in STAMPS. For "Intro Pack" of ten picture tapes of the best, various subjects, various lengths (total run time - 2 hours 12 minutes), send \$6.00, immediate delivery, POST-PAID, listing included. Due to popularity of above, "Intro Pack Deluxe" now offered, run time 12 hours 44 minutes, \$30.00, shipped PRIORITY mail in USA, surface postpaid overseas. Joe Dickens, WA9UGE, 601 S. Dodson, Urbana, IL 61801.

LOOK, NO TOROIDS! Audio frequency shift oscillator uses active filter instead of toroid inductors. IC oscillator insures stable operation. Switchable 170 Hz or 850 Hz shift. CW ID keying input. Wire in direct or use PC edge connector. Plug-in replacement for AK-1. Universal mounting. PC board measures 2 5/8" x 2 7/8". Complete kit (\$21.00) includes etched and drilled PC board, all necessary parts and instructions. (Power supply not included.) Wired and tested; \$29.00. Order FS-1 from Fleisher Corp., P.O. Box 902, Topeka, Kansas 66601. Master Charge, BankAmericard, telephone orders accepted (913-234-0198).

GIVE YOUR KEYBOARD, KEYPAD, AND SUPPORT electronics a handsome home with the UNIVUE keyboard and instrumentation enclosure. Only \$32.95 plus shipping on 17 lbs. Stamp brings additional information. ADS, P.O. drawer 1147, Marion, OH 43302. (614) 382-7917.

CLASSIFIED ADS--See Page 16