

RTTY AT THE ARRL CONVENTION IN PHOENIX

The Southwest Division ARRL Convention was held in Phoenix during the time May 26-27-28, 1961. Approximately 2,000 people attended, as judged by the size of the crowd at the banquet in the auditorium room of the Hotel Westward Ho. Some idea of the size of this room may be had by the fact that there was a "diminutive" full sized 40-meter two-element beam fully assembled and hanging from the ceiling — the beam being one of the raffle prizes. Some effort was made, unsuccessfully, though, to get W6AEE to win this beam in order to put a better signal into the Bay area from down South.

When Merrill and Margaret and I arrived in Phoenix at nine p.m. Friday evening after an eight-hour trip across the desert from Los Angeles, we found a sizeable crowd already present. The next morning when the Convention rooms opened, we found two teleprinter machines already set up and in more or less use for routine communications between the main floor and the eleventh floor offices of the ARRL Convention. I began setting up the gear we brought along — a Mark IIIB TU with its just-finished Oscillo-analyzer unit and a BC-348Q receiver to tie into the landline circuit for some real honest-to-goodness RTTY reception.

We met Jerry W7VMN and George K7BXS — the owners and operators of the Model 15 and 19 printers in the landline. It was indicated to them that we desired to operate a RTTY receiving station, and they cooperated with us simply by disabling the landline loop supply and patching into the TU system. As a result, RTTY reception was had on various commercial and amateur signals all day both Saturday and Sunday. The equipment was placed in full public eye, and as usual the RTTY equipment, in action, drew a large crowd. Excellent reception of signals from such stations as K6DLK in Pasadena, and various W7's, W5's and W0's were had thus demonstrating the effectiveness of Amateur RTTY.

In the afternoon, a RTTY session was held in one of the hotel rooms, and about 75 people were present to hear Merrill, W6AEE, discuss the principles behind RTTY and talk about some of the new terminal units recently developed. The Mark IIIB TU as well as the W2JAV transistor converter were on display, and copies of circuits were passed around.

About 50 people were present at the RTTY Breakfast the next morning. An excellent meal was had, and afterwards W6AEE again gave another talk. Afterwards

we joined in the usual Convention activities, and toured the manufacturers displays. Particular note was taken of the SX-115 receiver, the various panadaptor units, and the many interesting displays of homebuilt gear arranged on the stage of the auditorium room. Some of the crowd took dips in the hotel's pool, and others lounged in the patio in the center of the fabulous Westward Ho.

The banquet was held at four p.m. at which several speakers of note, such as Senator Barry Goldwater, Mayor Mardigan of Phoenix, Ray Meyers, W6MLZ, the Southwest Division Director, gave very illuminating speeches. All in all, the activities of this Convention indicated a dynamic and progressive Amateur Radio, and there was a pervasive feeling that there are many frontiers yet to be explored. During the time a visit was made to the Mummy Mountain Radio Club in Scottsdale, Arizona, and we were treated to the sight of K7LJA's equipment — three complete 1-kw stations, along with a variety of antennas and beams, fully adjustable in direction and height. All in and around a specially built Ham Clubhouse in a landscaped desert setting.

We left for home immediately after the Banquet, and arrived in the L.A. area about 3 a.m. — tired but happy in the feeling that we had a most enjoyable time in Phoenix, and that we had a successful RTTY show. I would like to express our deepest appreciation to W7VMN and K7BXS as well as others concerned for their magnificent cooperation in helping us with teleprinter equipment, etc. And I am deeply grateful to Merrill, W6AEE, for his interest and help in getting information RTTY-wise across to the crowd.

de Bob W6NRM



W6AEE Showing the W2JAV Transistorized TU



RTTY Breakfast, ARRL Convention, Phoenix, May 1961



Floyd, W7FKK taking a peek at copy.

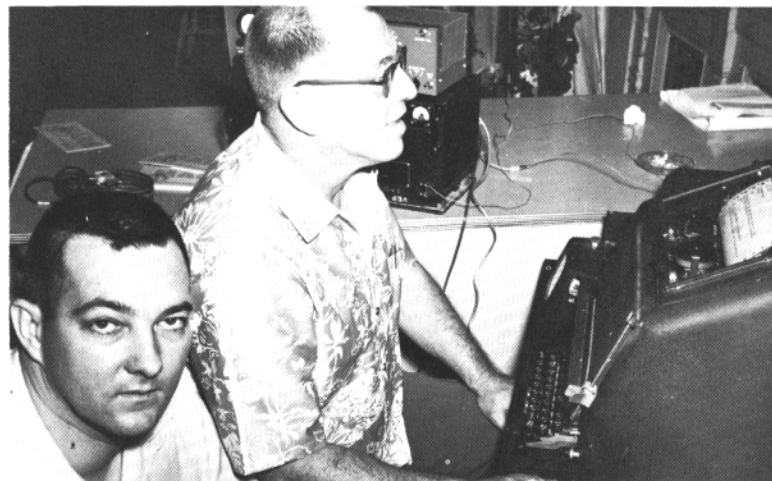

Jerry, W7VMN and George K7BXS

U. S. Senator, Barry M. Goldwater, ex-6BPI, in his appearance before the South-west Division Convention, May 28, 1961, in Phoenix, Arizona, told 1,100 amateurs that "complete communications between the peoples of the world will be the only solution to peace." The Senator further challenged the hams, "wouldn't it be great for hams here in the United States to discuss this country's ideals with other hams around the world?" He added, "that once the U. S. begins to show other countries that Americans want no advantage over them, that we are all "created equal," then we will have taken the first big step toward world understanding.

He further pointed out that this could be done by hams who know what America is and what it stands for, and suggested

that we could find out very easily.

The Senator admitted that he has an SX-88 receiver hidden in a handy spot so he can listen to us and used the experience to praise those who take a few faltering steps in the direction of speaking Spanish on the air to Latin American contacts.

Commenting on the damage of past American "boasting" material possessions rather than spiritual assets, he added, "If we can pass on how simple and how beautiful the feeling of Americans are, we can erase this ugly image of the American that now exists.

The Ham fraternity picked up a strong ally when the Senator promised us full support in the move for reciprocal licensing. It was a well-place plug with the representatives from the seven countries which took part in the convention.



SENATOR Barry Goldwater, ex-BPI, Ray Meyers W6MLZ, ARRL SW Division Director.

FIRST "WORLD-WIDE RTTY SWEEPSTAKES"

This is a competition between all stations throughout the world to determine their ability to exchange messages via two-way radio teleprinter.

SWEEPSTAKES RULES

1. **Test period:**
0200 GMT Oct. 21st to 0200 GMT Oct. 23rd, 1961.
2. **Bands:**
This test will be conducted in the 3.5, 7.0, 14.0, 21.0 and 28.0, MCS. Amateur Bands.
3. **Stations may not be contacted more than once on any one band. Additional contacts may be made with the same station if a different band is used. In the interest of encouraging multi-band DX operation, the same country may be claimed more than once if contacted on different bands. The same state worked on more than one band may only be claimed once.**

4. **Country Status:**
For the purpose of this contest, KH6, KL7 and VO will be considered separate countries in addition to the ARRL country list.

5. **Stations will exchange messages consisting of:**
 - (A) Message Number
 - (B) Check (RST)
 - (C) Time in GMT
 - (D) State of foreign country

6. **Points:**
 - (A) All two-way RTTY contacts by North American countries including KH6 will earn a maximum of two points (one sent plus one received).
 - (B) All two-way RTTY contacts by countries other than in (A) above will receive a maximum of ten points (five sent plus five received).
 - (C) All stations receive 200 points per country worked not including their own.

7. **Scoring:**

INCLUDES ALL NATIONS

 - (A) Two-way plus one-way exchange points times total states worked.
 - (B) Total country points per band times number of continents worked.
 - (C) Add item (A) and (B) above. (This is your total test score.)

8. **Sample score sheet:**

| | | | |
|---------------------------|------------------|--------|--------------------|
| | (196) | (40) | (7,840) |
| (A) Exchange points | Times states | equals | |
| | (800) | (3) | (2400) |
| (B) Country points | times continents | equals | |
| | | | (10240) |
| (C) Add (A) and (B) above | | | (Total Test Score) |

9. **Sample Log:**

| W6TPJ | | | | | | 21, Oct. 1961 | | | |
|-----------------------------|-----|------|------------|---------|----|----------------------------------|------|------------|----------------|
| Station Log of _____ (Call) | | | | | | Date _____ | | | |
| SENT | | | RECEIVED | | | STATE OR EXCHANGE COUNTRY POINTS | | | |
| NR | RST | TIME | BAND | STATION | NR | RST | TIME | COUNTRY | POINTS |
| 1 | 589 | 0200 | 14 | W6CG | 2 | 589 | 0204 | Calif. | 2 |
| 2 | 509 | 0230 | 14 | VK3KF | 6 | 579 | 0231 | Australia | 2 |
| 3 | ? | ? | 14 | W6NRM | 4 | 359 | 0240 | - | 1 |
| 4 | 599 | 0300 | 14 | W2JAV | 7 | 599 | 0259 | New Jersey | 2 |
| 5 | 579 | 0514 | 7 | VK3KF | 22 | 509 | 0514 | Australia | 2 |
| Total exchange points (9) | | | States (2) | | | Countries (2) | | | Continents (2) |

| VK3KF | | | | | 21, Oct. 1961 | | | | |
|-----------------------------|-----|------|------------|---------|---------------|-------------------|------|-------------|----------------|
| Station Log of _____ (call) | | | | | Date _____ | | | | |
| SENT | | | RECEIVED | | | STATE OR EXCHANGE | | | |
| NR | RST | TIME | BAND | STATION | NR | RST | TIME | COUNTRY | POINTS |
| 1 | 599 | 0201 | 21 | ZL3HJ | 1 | 599 | 0202 | New Zealand | 10 |
| 2 | 589 | 0204 | 21 | W6CG | 1 | 569 | 0205 | Calif. | 10 |
| 3 | 589 | 0210 | 21 | W6NRM | 3 | 569 | 0210 | - | 10 |
| 4 | 569 | 0220 | 14 | W6AEE | 2 | 569 | 0222 | - | 10 |
| 5 | 579 | 0224 | 14 | VE7KX | 9 | 589 | 0225 | Canada | 10 |
| Total exchange points (50) | | | States (1) | | | Countries (3) | | | Continents (2) |

NOTE:

Log the state only once the first time contacted. Log the country the first time contacted on each band. (See Sample Log para. 9.)

10. Logs and score sheet should be received by RTTY, Inc., 372 West Warren Way, Arcadia, California by December 1, 1961 to qualify.

ARMED DAY FORCES DAY RATT MESSAGE

CQ CQ CQ DE NSS NSS NSS
BT

All amateur radio operators are invited to copy the message to follow and submit the transcribed copy to Armed Forces Day Contest CMM RM BE1000 CMM the Pentagon CMM Washington 25 DC PD A Certificate of Merit will be sent to each participant who submits a perfect copy made from the Radioteletypewriter Transmission of this message.

BT

CQ CQ CQ DE NSS NSS NSS NR 2

R 202130Z

FM Washington, DC

To all radio amateurs

GR 115

BT

The rapid expansion and growth of the amateur radio teletype service during the past year is a particular tribute to those radio amateurs who pioneered the early development of this highly technical but most efficient communications medium PD Today amateur radio teletype networks span the entire nation providing the means and opportunity for further developments in this specialized field and at the same time offering an emergency communications network with greatly increased traffic handling capability PD The chiefs of the Armed Forces Communications Services and your fellow radio amateurs in the Armed Forces join me in extending congratulations for your accomplishments and best wishes for continued success SGD. Robert S. McNamara CMM Secretary of Defense.

BT

CQ CQ CQ DE NSS NSS NSS CQ CQ
CQ this is NSS NSS Washington D.C. K
CQ CQ CQ CQ DE NSS NSS NSS listening
near 3620 Kc and 21090 Kc break in at
any time we have two receivers listening
at all times and are scanning near those
frequencies.

W6AEE W6AEE this is NSS NSS Hi
Merrill you ole scoundrel!!! You are busting
our ears here. Sure would appreciate your
putting out QST QST on this freq to tell
gang to work us. Ole Floyd sitting here
hanging over me and scanning 3620 and
Phil the cat over on 7375 scanning 7140.
Here is Floyd.

Hi Merrill and hello. If I can't work you
from home I go where the power is.

Subscription Rate \$3.00 Per Year
RTTY is the Official Publication
of the
RTTY Society
of Southern California
and is published for the benefit of all
RTTY Amateur and Experimenters

Permission to copy is granted
provided credit is given.
For "RTTY" Information:
W6DEO W6CG W6AEE

A NEW RTTY SERVICE

We are very pleased to announce a new service for the operators of amateur RTTY gear throughout the U.S.A. and its possessions. Since parts for these machines seem either hard to come by, or not knowing where to obtain them, we have persuaded the commercial teletype men, that recondition our machines, to set up a parts service for the amateurs. We suggested that they call it "Amateur Printer Repair & Supply" which they have done. If you need a part, please write Amateur Printer Repair & Supply or APH&S P.O. Box 290, Independence, Missouri. They have advised me that they will give very prompt service (48 hours) and the part will be on its way to you. The charges will be along the amateur scale and far below the actual list price of the article. There is one exception to this, and that is, if they have to order the part from Teletype, then they in turn will have to charge accordingly.

They will stock most parts for the MOD

15 machine which will include the 60 speed gears (74912 & 74913), the conversion kits from "C" to "A" type, plus all the other parts the amateur will need. They will repair your machine if broken down, should you desire it.

You may order by Teletype number or send in a description of the function the parts play in the printer operation. If you have the old part, (broken or damaged) you might send it along if you don't know the part number.

They will not sell to commercial interests, so I would suggest that you include your amateur call with your order, so that they will not have to verify that you are qualified to receive parts from them; thereby eliminating any delay.

So remember, if you need a part, your machine reconditioned or repaired, write to Amateur Printer Repair & Supply (APR &S) P.O. Box 290, Independence, Missouri.

DE A6YJG KKK

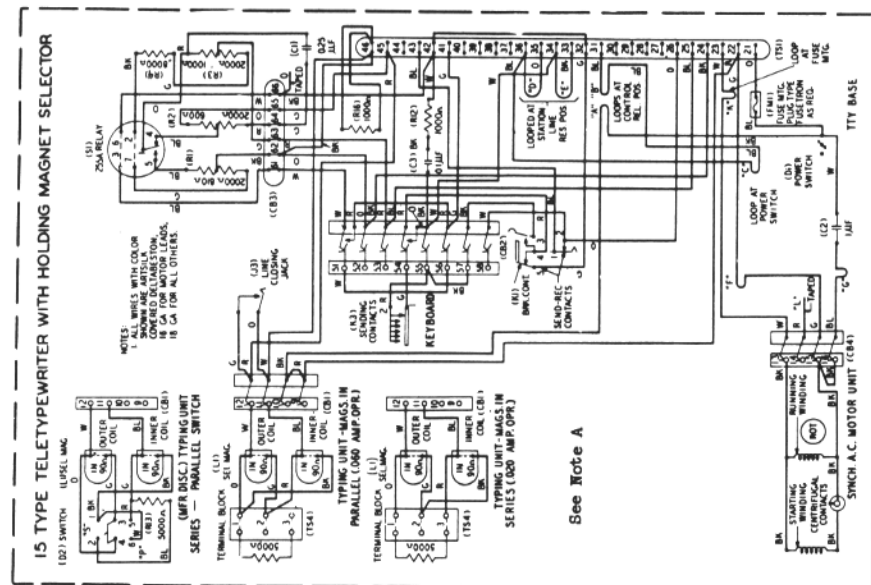

TWO NEW HIGH-SPEED TAPE UNITS BY THE TELETYPE CORPORATION

Two, high-speed 100-character-per-second tape units are being introduced by the Teletype Corporation. This equipment is designed for use in message and data communications, including various computer applications and other data handling communications uses.

Designated the "BRPE" tape punch and the "CX" tape reader, these units operate as a complementary "matched pair" for use in high-speed, tape-to-tape communications systems. They also can be used as input and output devices for computer and other data communications installations.

The CX, which reads either fully perforated or chadless tape, can be used to transmit data collected from the BRPE or slower speed equipment. The BRPE's tape output, in turn, can be relayed by the CX or by compatible equipment at slower speeds.

The CX and BRPE operate on parallel-wire signals which can be serialized by Teletype electronic equipment. With these facilities, and additional terminal equipment, the units can be used for high-speed

communications over conventional voice channels. These sets are capable of inter-operating with transistorized or vacuum tube circuits.

Each unit is equipped with a pulse generator which has a timing cycle that is adjustable throughout 360 degrees to actuate control circuits. This synchronizing pulse controls the accurate timing of intelligence to and from associated equipment.

The BRPE punch produces fully perforated tape and is available in two models, one of which operates at a 5 level code, and the other adjustable to 6, 7, or 8 code levels. The set weighs 28 lbs. and measures 12 inches high, 8 inches wide and 16½ inches deep.

The CX reader adjusts to 5, 6, 7, or 8 levels. The entire unit is 5 inches high, 6 inches wide, 11 inches deep, and weighs 12 lbs.

Descriptive literature is available from the manufacturer. Write to Teletype Corporation, Dept. SP-12, 5555 Touhy Ave., Skokie, Illinois.

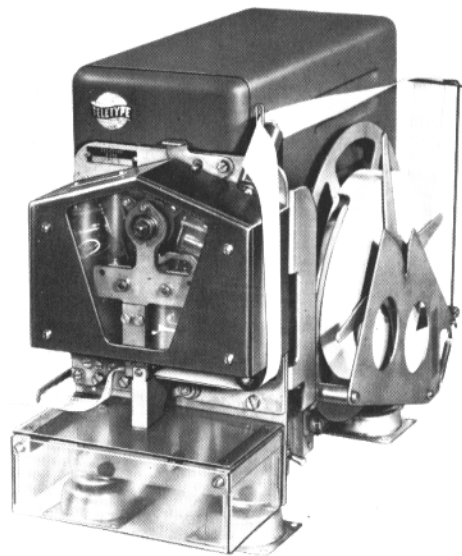

FSK ADAPTOR FOR HEATH APACHE

By C. A. (COLE) ELLSWORTH, KR6MF/K50LU

A quick and easy method of modifying the Apache, TX-1 for FSK was needed. Several FSK circuits from RTTY and CQ were considered and we finally chose the W6-AEE Heathkit VFO FSK modifications as the circuit with the most desirable features of operating convenience and stability consistent with a minimum number of components. This circuit provides the keyboard contacts with sufficient voltage to breakdown any oxide or oil film, thus reducing pulse distortion. The 6AL5 provides stable electronic switching and standard "mark low" keying. An externally mounted 1 meg pot allows precision adjustment of shift. All necessary operating voltages are ob-

tained from the Apache power circuits.

A particularly pleasing aspect of the adaptor is that no holes need be drilled in the Apache. The adaptor may be removed in five minutes with a soldering iron and screw driver.

In the original version of this adaptor, the Apache was rack mounted so it was easy to use a 3 circuit phone jack and plug to connect the adaptor to the keyboard. For standard cabinet mounting of the Apache the connections to the keyboard may be made through the TX-1 accessory socket.

For those who are experimentally inclined, silicon diodes with sufficiently high PIV should work equally as well as the 6AL5.

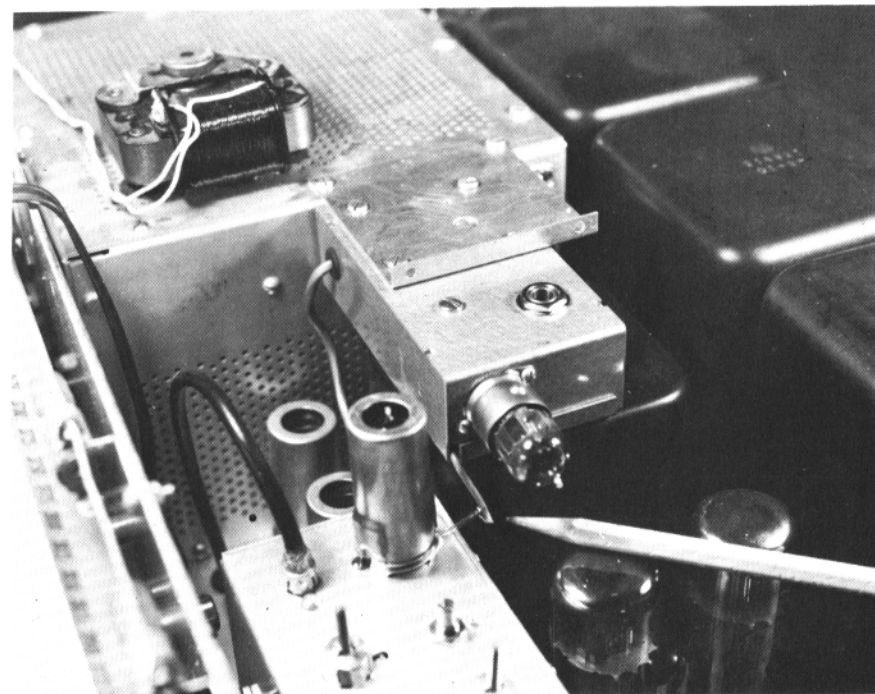

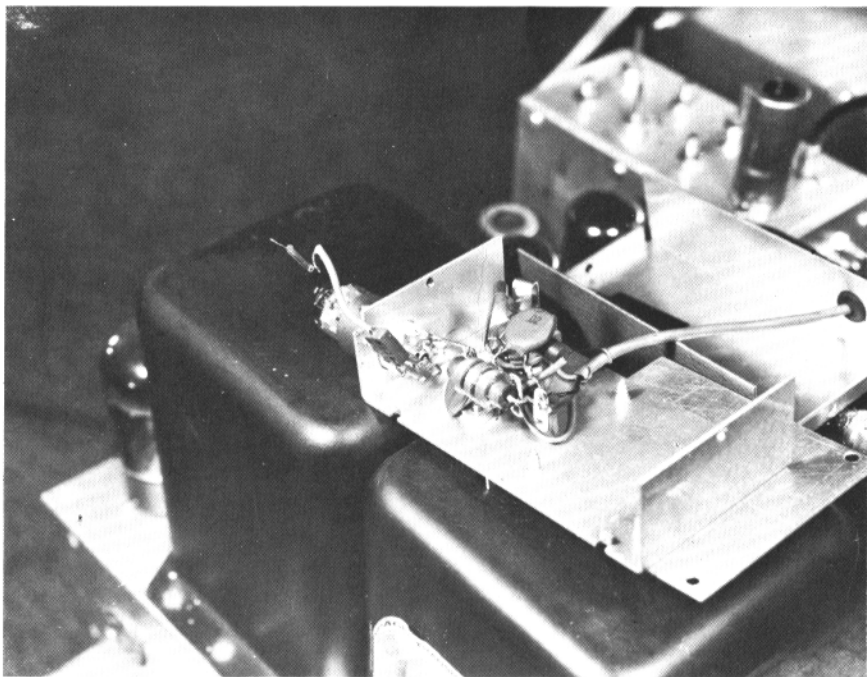

KR6MF

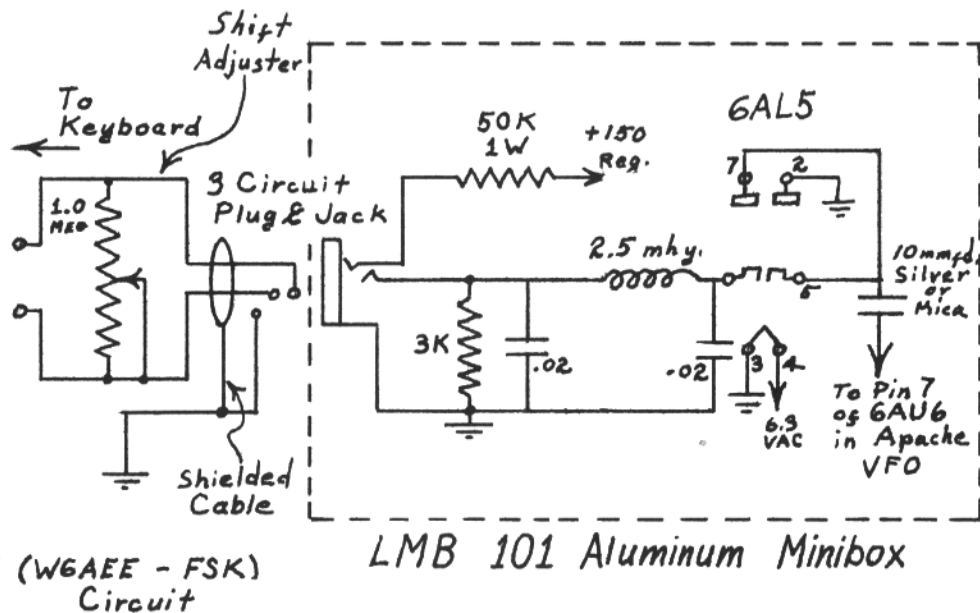

"DX RTTY"

By JERRY EDMISTEN, W6TPJ
9127 E. Valley Blvd., Rosemead California

Hi Gang:

Looks like what started out to be a good case of Spring Fever with your regular DX reporter Bud, W6CG, turned out to be an infection that the Doc is still trying to analyze. Bud will be in the Hospital for a week or ten days and should be back with us for the next issue. This all happened about four days before the deadline for the DX column as Bud usually holds off on writing the column until the last minute to bring you all the latest information. As a result of this I will try to bring you what information I could dig up going through Bud's correspondence.

For you that have never visited Las Vegas, Nevada, and had the opportunity to hit the jack pot on a Silver Dollar machine, here is about as close as you can get. Bill, G3CQE managed to hook PY1KU and VS1HU by two-way RTTY both in the same day! Bill needed both of these continents to fill in his RTTY WAC. This makes Bill the first station in England to receive this award as well as the first G to PY contact. Congratulations, Bill. Bill is off on a new job away from his home in Norwich and for the time being will only be able to occasionally operate on the week-ends.

For those of you that need South America for your WAC, Edwin, PY1KU has been active during the week-ends and another station OA4BN, Frank showed up for the first time on May 31 at 0530 GMT. His first contacts were W4MJI and myself. During the QSO he said his machine was making so much noise he was afraid the neighbors would complain and call the cops. He was going to show up the next night after he cleaned up some of the haywire and put a thick rug under the machine. Haven't heard him since! Frank is very interested in making as many QSOs as possible so if he ever gets back on you will have no trouble working him as he puts in a very nice signal. PY1KU does all right in the signal department also as G3CQE said his signal was the strongest DX signal he had ever heard.

Doc, G2UK informs us that BARTG has an official status now that it became affiliated to the RSCG in April. About 100 members enrolled with about 20 of these active mostly on the VHF and 80 meter bands. Doc also reports lots of activity within DL, but apparently only DL1GP has

managed to bag a contact outside DL. The other DL Stations are using the Hell-scriber system. DL1GP is trying to stimulate some interest in Switzerland.

VK3KF, ZL3HJ, ZL1WB and KM6BU are still active around 0500-0800 GMT on 14.090 Saturday evenings. VK2EG hopes to meet Eric, VK3KF at the annual reunion of the Antarctic Club in June. VK2EG, Bill hopes to be active soon.

KG6AAY was heard testing on RTTY late one Saturday evening on 14 mcs. He was not printing too well because of either speed or distortion troubles but did manage to get his call a few RYs and a QRZ. Called him but couldn't make a contact of it. Sounds like the boys on Guam are getting ready to launch an offensive!

KR6MF, Cole who holds the call of W50LU has been running CQ tapes for the past three weeks on 14.095 mcs. between 0830-0930 and 1300-1500 GMT without a single W station taking the bait! Only RTTY contact to date has been KM6BU. Cole could keep the boys on the RTTY WAC committee busy printing WAC certificates. Asia is probably the most needed continent for a lot of us so let's give Cole on Okinawa some business.

The "First World Wide Sweepstakes" contest rules have just been completed and will be published in an up-coming issue of RTTY. Copies of the rules will be sent to CQ, QST, and SWM (Short Wave Magazine). Tapes of the contest rules will be sent to stations throughout the world requesting that they be transmitted from time to time until the contest date of Oct. 21, 1961. By the time the contest takes place, everyone should have the information necessary for scoring and logging. This will be a completely new contest encouraging DX activity as well as W/K participation. The contest committee would like to thank the many stations who took the time to submit their suggestions to make this contest possible. Awards for this contest have not been decided upon as yet, but I can assure it will be a worthwhile one.

We all hope Bud will be back in the saddle again next issue and feeling up to his old self again. So, as my friend Bud would say "Keep Your Powder Dry" and BCNU next month.

73—Jerry, W6TPJ

RTTY SOCIETIES

Left on the cutting room floor, were the following Societies.

NCARTS

Northern California Radio Teleprinter Society, Art Slopper, W6MXJ, 436 Madrid Street, San Francisco 12, Calif.

SLATS

St. Louis Amateur Teleprinter Society, Robert E. Ford, W0MPF, 5422 Bermuda Avenue, Normandy 21, Mo.

One other society was mentioned, but as far as your editor knows, there have been no meetings of its members. The above listings are active groups who meet regularly, and are not selling gear only.

THINKING OUT LOUD

It has been recently brought to my attention, that plans are under way to form a Federation of Amateur Radio Teletype Societies. This at first sounds like a great idea, but — let's take another look see. We, amateurs already have an excellent national group which represents us. I am talking about the AMERICAN RADIO RELAY LEAGUE. It has stood the test of many factions in the past who were not satisfied with its actions but before we attempt to start another group to represent us, why not do as is done in other types of clubs. If you don't like what they do, join and make your wishes known. Take part, write your director, SCMI, and above all take part in their activities. W1AW is on RTTY and has taken part in past RTTY SS contest, they have asked for material to be used in QST. Five of the Directors, present at the last Board Meeting are on RTTY. The general manager was directed to file necessary papers to obtain removal of the dual identification (CW) requirement. Those who read the Communications Department each month, have read material printed on RTTY doing at various times. Getting behind ARRL for action on RTTY matters would seem to your Editor to make good sense. A group, such as has been proposed would hardly be able to do as much as we can expect from ARRL.

I am sure that there are those who will not agree with me, so let's hear from you.

—30—

RTTY FREQUENCIES

3620 7040 14090 21090

Last month we printed the above suggested frequencies, in order to stir up some comments. So far, nothing has been heard. The main change is the 7040 kcs frequency on forty meters. There are many reasons for this frequency, first, our fellow amateur in other lands, do not have RTTY on the old portion which we have been using (7140) so in order to communicate with each other, a new frequency seemed in order. After a lot of letter writing and listening on the parts of the committee, the 7040 spot was selected. Again, please let us know, your thoughts, gripes etc.

—30—

Every once in a while a situation will arise which seems to satisfy the need of US DX for the occasional "thrill" of discovering a new station hitherto unheard. While I am not the first to QSO the one in question I think this is his first complete outside QSO of any great length. I refer to PY1KU in Rio de Janeiro, Brazil.

I have been looking for a South American QSO for sometime and this was my first. He told me he had worked another W station whose call he didn't remember. But he did recall that the man told him about a "Mr. Merrill." This feller "Merrill" had lots of info on RTTY for hams but that was all my friend Edwin Rivera learned from the previous QSO. PY1KU is the "Mr. Merrill" of Brazil and since I find the whole QSO quite interesting from the standpoint of his background as well as the difficulties he and his friends — PY1LM and PY1JB have had in getting their RTTY on the air. Apparently the first outside station he heard was Bruce ZL1WB but he explains they were using tape to transmit thru a 14 TD and till they got the tape punched and in the excitement they failed to come back to Bruce's call in time to get the QSO. Edwin wants to be the first PY ham to work the states on forty meters and he and I have a sked. Friday nite on 7040 he went to great lengths to show me that no other freq. would be any good for the South Americans. I am taking the liberty of including the copy from PY1KU since I think with my help in red pencil for deciphering it you will find a great deal of charm in his story . . . At least what you can read of it. Condx to Europe have been terrible for the past month. I haven't hrd one RTTY signal from England in that time.

Have had a number of fine QSOs with Eric on fifteen and twenty meters recently and he tells me he has applied for forty meter clearance for 7044 but thinks 7040 would be fine. Alec ZL3 HJ and Bruce come thru better lately and things are looking up out their way. Won't belabor you with miles of typing but wanted you to know condx to the West Coast have been mighty poor . . . fifteen is very dependable anyway and lately it hasn't bother to open for days around these parts.

Here is an airmail subscription of "RTTY" for —

Edwin F. Rivera, PY1KU
Rua Real Grandeza 59
Bloco 12
Botafogo
Rio de Janeiro
Brazil

Any back issues you might spare would be so greatly appreciated by the Brazilian RTTY guys. I hope you can find some and airmail them to Edwin for use in interesting other "hands". As he says in the enclosed copy — "We will welcome because there are more people being contaminated, here and I will be glad to help" . . .
Ed, K3GIF

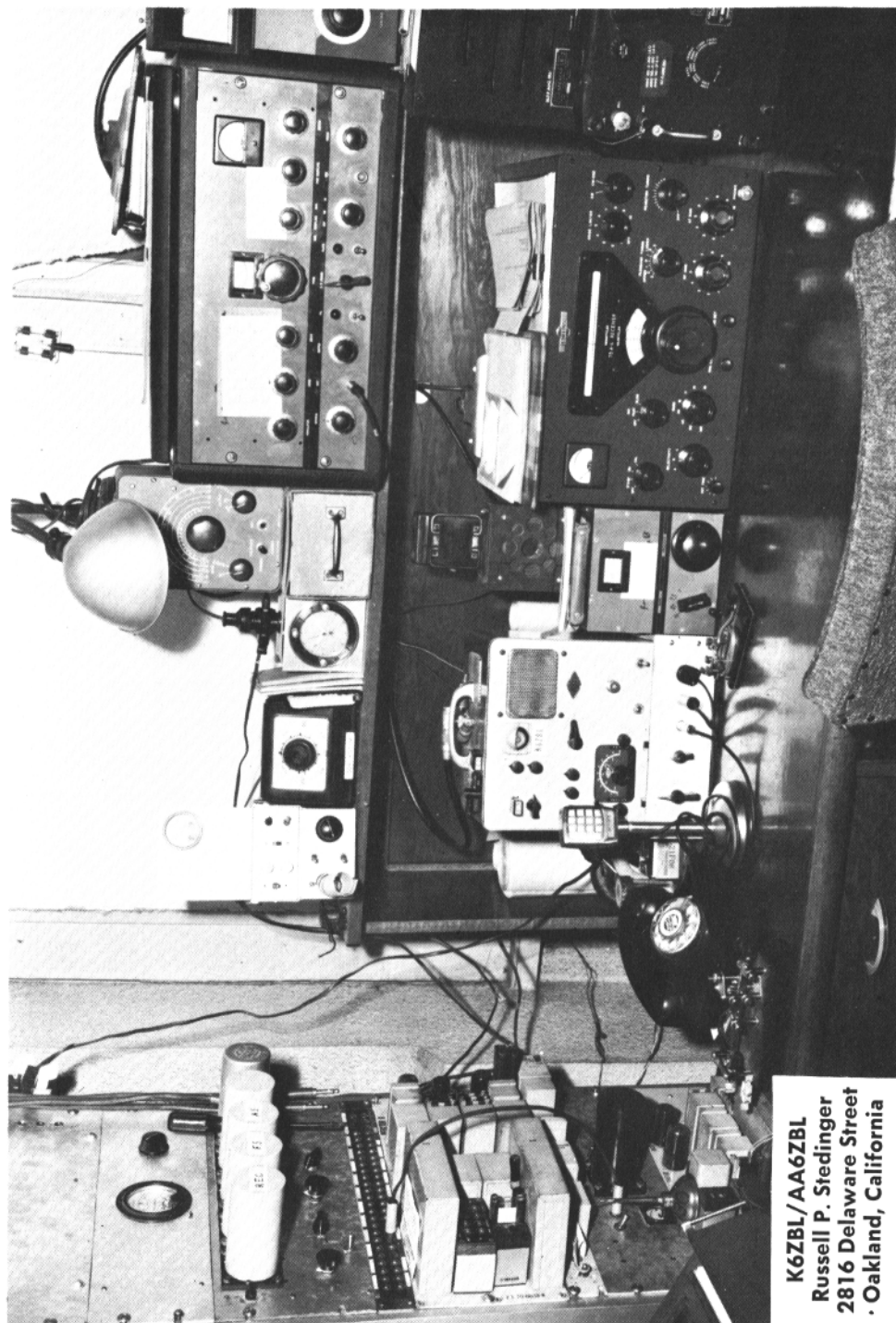

K6ZBL/AA6ZBL
Russell P. Stedinger
2816 Delaware Street
Oakland, California

