

BELL SYSTEM PRACTICES
Teletypewriter and Data Stations

SECTION P34.355
Issue 3, August, 1963
AT&TCo Standard

28-TYPE TAPE TYPING UNITS, 28-TYPE TAPE TELETYPEWRITER BASES, AND 28-TYPE TAPE TELETYPE- WRITER COVERS

WIRING DIAGRAM

1. GENERAL

1.01 This section shows the wiring for the 28LA and 28LA-1 tape typing units, 28LA, 28LB, and 28LC tape teletypewriter bases, and 28LA and 28LB tape teletypewriter covers for use in 28KSR tape teletypewriters. The 28LB and 28LC bases are equipped with a 28-type keyboard and are designed to mount a 28LA-1 tape typing unit. A 28E motor unit is used with the 28LB base and a 28C motor unit is used with the 28LC base. The 28LA tape teletypewriter cover is designed to be used with the 28LA teletypewriter base and 28LA tape typing unit.

1.02 This section is reissued to release modified wiring diagrams for the 28LA, 28LB, and 28LC tape teletypewriter bases, the 28LA and 28LB tape teletypewriter covers, and the 28LA and 28LA-1 tape typing units.

28LA AND 28LA-1 TAPE TYPING UNITS

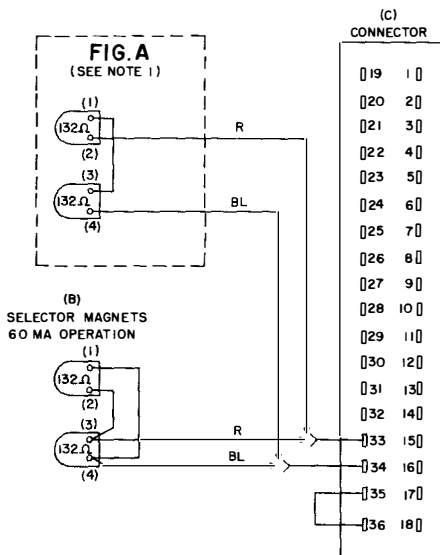

NOTES:

1. FOR 20 OR 30 MA OPERATION CONNECT SELECTOR MAGNETS AS SHOWN IN FIG. A

28LA and 28LA-1 Tape Typing Units

28LA TAPE TELETYPEWRITER BASE AND 28LA TAPE TELETYPEWRITER COVER

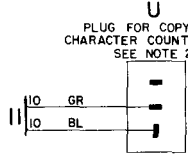
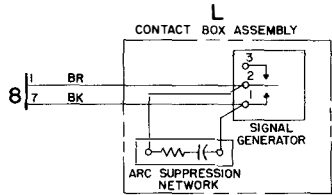
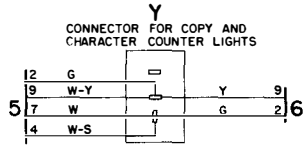
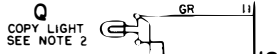
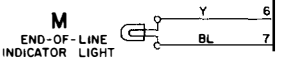
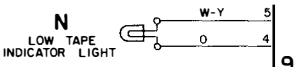
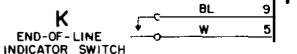
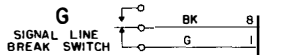
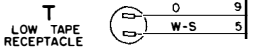
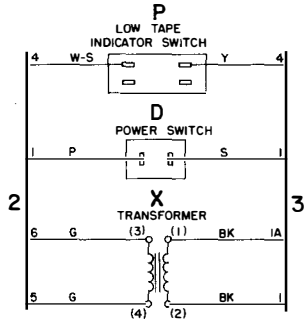
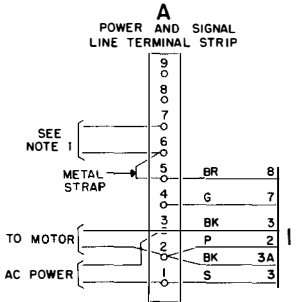

NOTES:
1 FOR CONNECTION TO SELECTOR MAGNETS
WHEN 36 PIN CONNECTOR IS NOT USED
2. COPY LIGHT (Q), CHARACTER COUNTER
LIGHT (R) AND PLUG (U) ARE PART OF
28LA TAPE TELETYPEWRITER COVER.

28LA Tape Teletypewriter Base and 28LA Tape Teletypewriter Cover

TAPE TYPING UNITS,
TAPE TTY
BASES,
P34.355 AND TAPE
Page 3 TTY COVERS

28LB TAPE TELETYPEWRITER BASE AND 28LB TAPE TELETYPEWRITER COVER

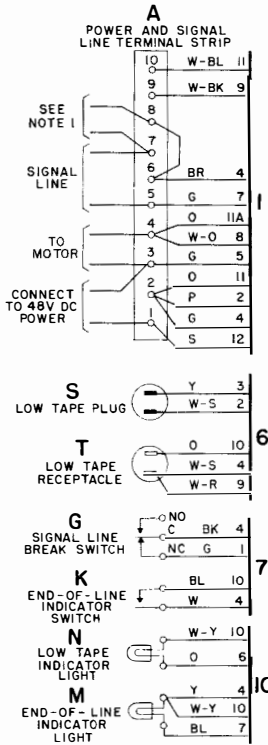

NOTES:

1. FOR CONNECTION TO SELECTOR MAGNETS WHEN 36 PIN CONNECTOR IS NOT USED.
2. (Q) COPYLIGHT, (W) CHARACTER COUNTER LIGHT AND (X) PLUG ARE PART OF 28LB TAPE TELETYPEWRITER COVER.

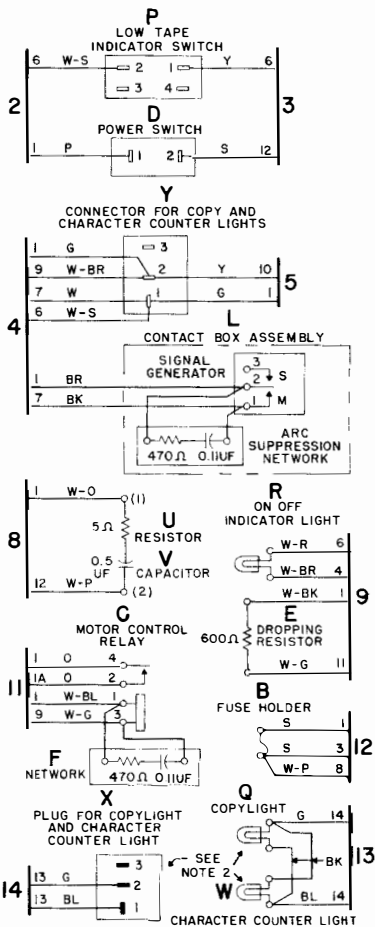

28LB Tape Teletypewriter Base and 28LB Tape Teletypewriter Cover

28LC TAPE TELETYPEWRITER BASE AND 28LA TAPE TELETYPEWRITER COVER

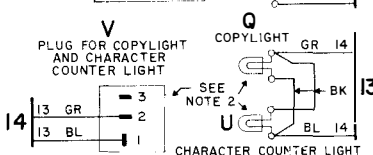
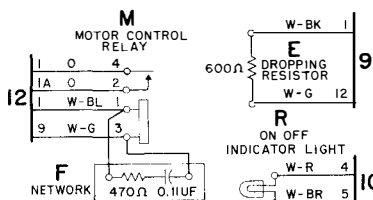
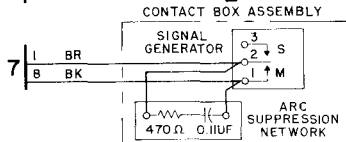
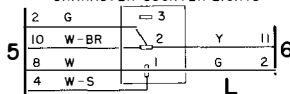
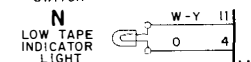
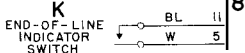
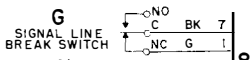
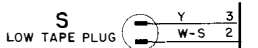
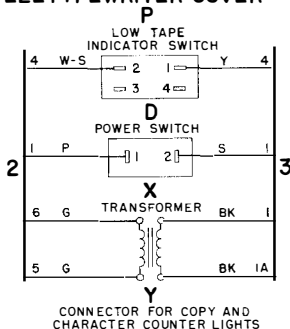
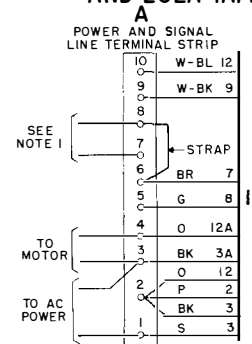

NOTES:

- FOR CONNECTION TO SELECTOR MAGNETS WHEN 36 PIN CONNECTOR IS NOT USED.
- (Q) COPYLIGHT, (U) CHARACTER COUNTER LIGHT AND (V) PLUG ARE PART OF 28LA TAPE TELETYPEWRITER COVER.

28LC Tape Teletypewriter Base and 28LA Tape Teletypewriter Cover

TAPE TYPING UNITS,
TAPE TTY
BASES,
AND TAPE
TTY COVERS

P34.355

Page 5
5 Pages

