

Bulletin No. 112
Issue 2
October, 1941

TELETYPE

PRINTING TELEGRAPH SYSTEMS

APPARATUS NOT USED BY
BELL SYSTEM

MULTIPLEX
SYSTEM

TELETYPE

CORPORATION

SUBSIDIARY OF

Western Electric Company

CHICAGO, U.S.A.

TELETYPE

PRINTING TELEGRAPH SYSTEMS

MULTIPLEX SYSTEM



CORPORATION
SUBSIDIARY OF
Western Electric Company
CHICAGO, U.S.A.

TELETYPE MULTIPLEX PRINTING TELEGRAPH SYSTEM

CONTENTS

	Page
General	1
Signaling Code	1
Transmission	1
Duplex Circuit	2
Reception	3
Transmitting Distributor Speed Control	4
Receiving Distributor Speed Control	5
Synchronism	5
Corrector Circuit	5
Correction Signals when Tape Transmitters are Idle	7
Complete Correction Circuit	7
Automatic Speed Control Units	8
Orientation	9
Synchronizing	10
Synchronizing by Count	10
Synchronizing Lamps	11
Distributor Tables	12
Relays	12
Line Relay Vibrating Circuit	12
Functions of Switches on the Distributor Table	13
Transmitting Locking Key	13
Line Battery and Ground Switch	13
Corrector Switch	13
E. Switch	13
Line Switch	14
Sounder Switch	14
Condenser Switch	14
Phasing Switch	14
Auto Speed Motor Switch	14
Operating Tables	14
Auto Stop Circuits	15
Auto Stop Circuits (For Transmitters with Two Pair of Magnets)	15
Auto Stop Circuits (For Transmitters with One Pair of Magnets)	15

	Page
Test Table	16
Test Distributor	16
Starting A Teletype Multiplex Circuit	16
Relay Contact Tongue Travels	17
Operating Table Switches	17
Distributor Table Switches	17
Fork Weights	17
Starting Distributors and Forks	18
A. C. Balance	18
Speed Setting	18
Speed Setting by Count	18
Speed Setting with Synchronizing Lamps	19
Phasing	20
Orientation Setting	20
Final Test	20
Three Channel Multiplex	21
Transmitting	21
Receiving	21
Speed Setting	21
Orientation Setting	22

TELETYPE MULTIPLEX PRINTING TELEGRAPH SYSTEM

General

The purpose of this bulletin is to describe the Teletype multiplex system and to provide information concerning its installation, operation, and maintenance.

The Teletype multiplex printing telegraph system consists of apparatus for automatically transmitting electrical signals and receiving and translating them into printed characters. This system when applied to send and receive two, three or four traffic channels simultaneously over a single line wire is called "multiplex." It is arranged to accommodate the equipment required for either two, three or four channel operation. The operation in each case being similar, this bulletin describes, theoretically, the two channel multiplex.

The message for transmission on each channel is first prepared on a paper tape by means of a perforator which is equipped with a keyboard similar to that of a typewriter. The tape is then automatically fed through a transmitter which in conjunction with a distributor transmits the signals, as represented on the tape, to the line. The received signals actuate relays. The signals from these relays are passed through the receiving distributor to the proper selector magnets in the printer. The printer translates these signals into printed characters.

Signaling Code

The signaling code used to transmit characters and functions is known as the five unit code with which a total of thirty-two combinations of operating and nonoperating intervals are possible. Hereafter operating and nonoperating intervals will be referred to as marking and spacing impulses, respectively.

Marking impulses or those which operate the corresponding selectors of the printer are represented in the tape by perforated holes, whereas the impulse positions on the tape for spacing impulses (those which do not operate selectors) are not perforated (Fig. 1). The sequence of transmission of the impulses on the tape is from the upper to the lower edge. Therefore, the first horizontal row of marking or spacing impulses represent the first impulse; the second horizontal row, the second impulse. The small holes below the second row are feed holes and are for the purpose of advancing the tape through the perforator and transmitter. The remaining three horizontal rows of perforations are the third, fourth, and fifth impulses, respectively.

Each vertical row represents the five intervals of a complete unit of time during each of which the current transmitted may be either positive or negative.

TRANSMISSION

Figure 2 shows theoretically the connections between the distributor and the two sets of transmitter contacts TA and TB used on A and B channels, respectively. The distributor cams which control the contact operation are located on a common shaft and are driven by a rotary converter.

The opening and closing of each pair of contacts is controlled by a cam through the medium of a plunger into the end of which fits a small fibre pin

(Fig. 3). The other end of the pin passes through a hole in the contact stop and moves against the contact spring. When the plunger rides on the high part of the cam, the contact spring will be held away from the contact stop. When the plunger drops into the cam notch, the contacts are permitted to close. From right to left, the cam controlled contacts CA and CB are connected to the five contact tongues of the A and B channel transmitters, respectively, (Fig. 2). The contact stops are connected together through the A.C. switch and A.C. contacts to the line and artificial line through the milliammeter and windings of the main line relay.

During one-half a revolution of the cam cylinder, cams CA closing contacts 1 to 5 in sequence will connect consecutively the five contact tongues of transmitter contacts TA to the line, thereby sending the combination of signals set up in the A channel transmitter. The combinations set up in the transmitter are determined by the perforated tape which positions the contact tongues against either the upper or lower contacts. Then cams CB will, in a similar manner, cause the combinations in transmitter contacts TB to be carried to the line during the remaining one-half revolution of the cam cylinder. At the same time cam A will allow its contacts to close and open completing the circuit from battery to the A channel transmitter magnets TMA, causing the tape to be advanced one character. During the time the next A channel combination is being sent to the line, cam B in a similar manner advances the tape in the "B" channel transmitter. It is to be noted that contact stops 1, 3, and 5 in the CA group and 7 and 9 in the CB group are connected together through the A.C. switch and through the "C" #11 A.C. contacts to the line. The #11 A.C. contacts will be permitted to close by their cam each time any of the contacts which are connected to them close.

A similar circuit exists in connection with the remaining contacts in the CA and CB groups and the #12 A.C. contacts. The low portions of the cams of the CA and the CB groups are slightly longer than one-tenth of their circumference, whereas the low portions of the A.C. cams are exactly one-tenth of their circumference. Therefore, the A.C. cams will do the actual making and breaking of the transmitted signals. Any slight irregularities in the adjustment of the CA and CB contacts will therefore not affect the length of the line signal impulses. The A.C. contacts may also be used for the purpose of sending alternating current to line up repeaters and for setting speed. It should be noted that the marking signals of the first four impulses of the A channel are positive and the fifth is negative. The first four marking impulses of the B channel are negative and the fifth is positive. The purpose of this arrangement is to provide reversals of current when no tape is being fed through the transmitter (as described under "Correction Signals when Tape Transmitters are Idle.")

From the foregoing it may be seen that the code combination set up in the A channel transmitter is distributed to the line during one-half of each distributor cam cylinder revolution and the B channel combination during the remaining one-half revolution.

DUPLEX CIRCUIT

In order to obtain simultaneous operation in both directions over one wire, a differential duplex circuit is used on the Teletype multiplex. Refer to Bulletin 131, "Duplex Printer Operation."

Figure 4 shows theoretically the differential duplex. At each end of the circuit is a differential line relay which has two similar windings. A terminal of one winding is connected to the artificial line and a terminal on the other winding is connected to the main line. The two other terminals of the

windings are connected to a milliammeter as indicated. The center connection of the milliammeter is connected to a pole changer. The resistance and capacity of the artificial line are adjusted so as to balance the resistance and capacity of the main line. Thus the outgoing signals will not affect the relay at the sending station.

The current applied to the main line at station B will unbalance the circuit and unequal currents will flow thru the two windings of the relay at station A causing it to operate. Similarly the relay at station B is operated by current applied to the line at station A. If both stations are sending at the same time the relays will be in positions corresponding to signals sent out by the distant station. The main line relay in operating actuates the printer relay which transmits the incoming signals to the printer.

RECEPTION

The receiving distributor is equipped with a series of contacts and cams similar to the transmitting distributor. Figure 5 shows the theoretical wiring and arrangement of the cams and contacts. Both contacts of the printer relay are utilized and the wiring from these contacts is arranged so as to rectify the reversed transmitting signals described under transmission. The left hand contact of the printer relay is connected to numbers one to four of the contact stops of CA group and #10 of the CB group. The right hand contact of the printer relay is connected to numbers six to nine contact stops of the CB group and to 5 of the CA group. Positive battery transmitted from the distant station will cause the printer relay tongue to move against the left hand contact and negative battery will cause it to move against the right hand contact. The contact springs of the CA group are connected to the A channel printer selector magnets and the contact springs of the CB group are connected to the B channel printer selector magnets. From the foregoing it may be seen that the printer relay tongue against either the right or left contact may cause printer selector magnets to be energized.

The cams on the receiving distributor must hold a certain phase relation with those on the transmitting distributor. Also both cam cylinders must be running at exactly the same speed in order that the receiving contacts corresponding to those of the transmitting distributor be closed simultaneously.

Tracing the circuit for the reception of the letter "Y" on the A channel, the sequence of operation is as follows: During the transmission of the first impulse (marking or positive battery) from the distant station, the printer relay tongue, to which battery is applied, is pulled up against the left hand contact applying current through the number one cam contacts to the first pulse selector magnets in the A channel printer. The second transmitted impulse (spacing or negative battery) will cause the printer relay tongue to be pulled against the right hand contact. Inasmuch as no circuit will be made from the printer relay tongue the second impulse printer magnet will not be energized. The third impulse (marking or positive battery) will again pull the printer relay tongue against the left hand contact, establishing a circuit through the number three cam contacts to the third selector magnets. The fourth transmitted impulse (spacing or negative battery) will cause the printer relay tongue to be pulled against the right hand contact. As in the case of the second impulse no circuit will be established to the fourth selector magnet. The fifth, a marking impulse (negative) of reversed polarity in relation to the first four impulses pulls the printer relay tongue to the right. Tracing the circuit from the right hand contact of the printer relay it will be seen that when the fifth cam contacts are closed the fifth pulse selector magnets in the printer will be

energized. The first, third, and fifth pulse magnets having been energized, the letter "Y" is set up in the printer during the first half revolution of the cam cylinder. During the second half revolution, the CB group of contacts are closed similarly to the CA group. Immediately following the closing and opening of the fifth contact in the CA group the A-6 contacts will close applying local battery to the sixth pulse magnets of the A channel printer. The sixth pulse magnets of the "B" channel printer are operated by the B-6 contacts which close immediately following the opening of the fifth impulse contacts of the CB group.

TRANSMITTING DISTRIBUTOR SPEED CONTROL

Figure 6 shows the transmitting distributor motor (rotary converter) and its associated apparatus for maintaining constant speed. DC is the direct current side of the armature which is connected to a direct current source of power through a rheostat. The shunt field is connected directly to the direct current source of power. AC is the alternating current side of the rotary and is connected to the primary side of a transformer in series with a lamp. The secondary winding of the transformer has a center tap which is connected to negative battery. The ends of the secondary winding are connected to two contacts on the transmitting fork. These contacts are alternately connected to battery through the contact spring C1 mounted on the left hand tine of the fork.

The fork is caused to vibrate by a magnet "M", the circuit of which is made and broken by the vibrations of the contact spring C2 (on the right hand tine of fork). The rate of vibration of the fork is determined by the weights "W" which may be set to give the desired speed.

It should be assumed that the weights "W" have been set to give the proper speed of vibration of the fork. If the fork is started it will continue to vibrate due to the making and breaking of the circuit through magnet M. The C1 contact spring moving against its right and left hand contacts will alternately send current through the two halves of the secondary winding of the transformer in opposite directions. This reversing of the current in the secondary winding will induce an alternating voltage in the primary winding of the transformer which is connected to the alternating current brushes of the rotary converter.

If the rheostat is adjusted so that the direct current will operate the converter at such a speed that the frequency of the current generated at the AC side is near the frequency of the alternating current produced by the action of the fork, the alternating current produced by the action of the fork will "pull" the rotary converter into synchronism with it. It is evident, therefore, that this motor will continue to run synchronized with the alternations produced by the fork.

Due to the fact that the speed of the fork is constant, the speed of the rotary will also remain constant. The lamp acts as a stabilizing load for the rotary and as an indicator, showing when the frequency of the rotary is the same as that of the fork. If the rotary and the fork are not in phase, the lamp will flicker due to the two out of phase currents, one produced by the rotary and the other by the fork. As soon as the two currents are in phase the lamp will be constant in its brilliancy.

RECEIVING DISTRIBUTOR SPEED CONTROL

The circuit for the receiving distributor motor control is similar to that which is used for the transmitting distributor as shown in Fig. 6. The receiving fork controls the speed of the receiving distributor as described in the preceding chapter.

The receiving fork has a pair of corrector magnets in addition to the driving magnet. The corrector magnets are mounted above and below the tines, on the receiving fork. If current is passed through the windings of these magnets, the magnetic effect upon the fork tines will increase the rate of vibration, thus increasing the speed of the rotary. The corrector magnets are used in connection with maintaining synchronism between the transmitting and receiving distributors.

SYNCHRONISM

Synchronism between the transmitting and receiving distributors is maintained as follows: The speed of the transmitting distributor is set at a predetermined value by placing the fork weights at the proper position for that speed. The speed of the receiving distributor is set so that it is slightly less than that of the transmitting distributor when the corrector magnet circuit is open. When the corrector magnet circuit is closed, the receiving distributor will run slightly faster than the transmitting distributor.

An automatic means is provided to open the corrector magnet circuit when the receiving distributor cam cylinder is slightly ahead of that of the transmitting distributor and to close the corrector circuit when the receiving distributor cam cylinder is slightly behind that of the transmitting distributor. It is obvious that the relation of the receiving distributor cam cylinder will oscillate between limits slightly in advance and behind that of the transmitting distributor. This variation is very small, the position of the receiving cam cylinder never advancing or lagging more than a few degrees from that of the transmitting cam cylinder. The application of current through the corrector magnets is controlled by the incoming signals.

Corrector Circuit

The corrector contact stops (Fig. 5) are wired together and are connected to the tongue of the line relay. The left and right hand contact springs are connected to the switch relay and to the corrector condenser respectively, for the purpose of controlling the operation of the corrector relay which in turn controls the corrector magnet circuit.

The right and left hand corrector contacts close and open alternately. That is, the right hand contacts open at the same instant that the left hand contacts close and vice versa. The length of the indents of the corrector cams is equal to one-half the length of a transmitted impulse. Therefore, when the receiving distributor cam cylinder is in phase with and running at exactly the same speed as the transmitting distributor cam cylinder, the right and left hand corrector contacts will close and open once (without any overlap) during each transmitted impulse. Obviously, any overlap of the operation of the corrector contacts in relation to the received signal impulses indicates an out of phase condition which will be corrected.

Figure 7 shows, graphically, the theory of the synchronizing circuit. Ten switch and corrector relay circuits are shown for the purpose of more clearly explaining the operation of the circuit, but in practice only one of each is used. The divisions 1 to 10 represent the ten impulses comprising one complete revolution of the transmitting distributor cam cylinder, together with a portion of the #10 impulse of the preceding revolution and a portion of the #1 impulse of the succeeding revolution. LR represents, graphically, the received line signals as they are conducted to the corrector contacts from the tongue of the line relay. The intervals CC, labeled A and B, represent the time intervals during which the left and right hand corrector contacts are closed. It should be noted that there is an out of phase condition existing between the received signals and the B corrector contact intervals as shown in the 3rd, 5th and 6th impulse divisions. The intervals B overlapping the impulse intervals as shown indicates that the receiving distributor cam cylinder is slightly behind that of the transmitting distributor and the receiving distributor will be speeded up.

The switch relay SR is connected to B (corrector contact) so that positive battery from LR (line relay) will cause the SR tongue to move against its left hand contact, and negative battery will cause the SR tongue to be moved against its right hand contact. The coils of corrector relay CR are connected to positive battery and through the contacts of SR in such a manner that CR tongue will be caused to move against its left hand contact (applying battery to corrector magnets CM) should relay SR tongue be caused to change its position during any B interval. The tongue of CR, however, will not be caused to move until the interval A of the succeeding impulse becomes effective. The direction in which the tongue of CR is moved is determined by the direction of current flow through either of its windings. The direction of current flow is determined by whether the condenser is charging or discharging and the position of the SR tongue.

It is to be noted that the positions of the SR tongue are shown as positioned by the preceding impulse, i.e. tracing the circuits shown in the first impulse interval, SR tongue is against the left hand contact as positioned by the preceding (Number 10) positive impulse LR. During interval A positive battery is applied to the condenser with no current flowing inasmuch as the condenser has been previously discharged. The tongue of CR is against the right hand contact with correction OFF and no current is being supplied to CM.

Interval B of the first impulse continues to hold SR tongue against the left hand contact. During interval A of the second impulse (negative) the condenser is charged, the current flow through the left winding of CR being in such direction as to effect no change in the position of its tongue, correction remaining OFF.

During interval B of the second impulse the tongue of SR will be moved against the right hand contact. Impulse three being negative, the CR-condenser circuit remains unchanged with the condenser still charged and correction OFF.

Near the end of Interval B, third impulse, there is a change in the polarity of LR indicating that the receiving distributor cam cylinder is lagging. The tongue of SR will be moved against the left hand contact, changing the characteristics of the CR-condenser circuit so that: During interval A of impulse 4 (positive), the condenser will be short-circuited, discharging through the left hand winding of CR in a direction to cause its tongue to move

against the left hand contact, correction ON.

During interval B of the fourth impulse there is no change in the SR circuit. Interval A of impulse 5 being the same as that of impulse 4, there will be no change in the CR circuit and correction remains ON.

Interval B of the fifth impulse changing to negative near its end, the tongue of SR will move against the right hand contact. During interval A of impulse 6 (negative), the condenser will be charged, current flowing through the right hand winding of CR in a direction to cause its tongue to be held against the left hand contact, correction remaining ON.

Interval B of the sixth impulse changing to positive near its end, SR will be moved against the left hand contact. During interval A of impulse 7 (positive), the condenser will be discharged through CR in a direction to continue to hold correction ON.

SR is unchanged during interval B of the seventh impulse remaining against its left hand contact where it was positioned by the impulse LR 7 overlapping into B 6. It should be noted that there is no overlap of signals at the end of interval 7 and correction will now be removed. During interval A of impulse 8 (negative), the condenser is charged, current flowing through the left hand winding of CR in a direction to cause its tongue to move against the right hand contact, correction OFF.

During interval B of the eighth impulse the tongue of SR is moved against the right hand contact.

During impulse 9 (negative) there will be no change in either CR or SR, correction remaining OFF.

During interval A of impulse 10 (positive), the condenser will be discharged, current flowing through the left hand winding of CR in a direction to hold its tongue toward the right, correction remaining OFF.

During interval B of the tenth impulse the tongue of SR will be pulled against the left hand contact, positioned for the first impulse of the succeeding revolution of the distributor cam cylinder.

Correction Signals when Tape Transmitters are Idle

Inasmuch as the operation of the corrector circuit depends upon incoming reversals, the receiving distributor would soon go out of phase with the transmitting distributor, if no reversals were sent.

To provide reversals during idle periods the fifth impulse of each channel is reversed as previously described under "Transmitting Distributor."

COMPLETE CORRECTION CIRCUIT

Figure 8 shows the complete correction circuit. The corrector contact stops are shown connected to the 1 mf. condenser and to coils of the switch relay SR respectively as previously explained. In the discussion of the corrector circuit it was stated that the corrector relay CR connected the

corrector magnet to battery. In practice, however, the corrector relay does not connect the magnet direct to battery but operates the corrector magnet through the medium of a secondary holding relay. It was also stated that the line relay was connected to the corrector contacts on the receiving distributor. In practice, the line relay operates the corrector control relay, the tongue of which, in turn is connected to the corrector contacts.

The right and left hand contacts of the corrector relay are connected to terminals on the right and left hand windings respectively, of the holding relay. The tongue of the corrector relay is connected thru the local contacts on the distributor to battery. Let us assume that the corrector relay has its tongue against its left hand contact and that the local contacts are closed for the first corrector operating interval. Current will then flow through the local contacts through the tongue and left hand contact of the corrector relay, through the windings of the holding relay to ground. The holding relay will move its armature against its left hand contact and connect battery to the corrector coils.

If the corrector relay has its tongue against the right hand contact a circuit will be made through the second windings of the holding relay to ground, causing the armature of the holding relay to move against its right hand contact and open the corrector coil circuit.

AUTOMATIC SPEED CONTROL UNITS

The following pertains only to those sets which are equipped with Auto Speed Control Units and Auto Speed Control Relays:

It should be noted that the coils of the holding relay and auto speed control relay are in series and that the tongues of the two relays operate in the same direction (Fig. 9).

The adjusting magnets are connected to battery through the rheostat which is controlled by the auto speed control motor. The motor turning in one direction will increase the resistance of the rheostat circuit and turning in the opposite direction will decrease the resistance, regulating the current through the adjusting magnets. A resistance is connected to each contact of the auto speed control relay. The opposite ends of these resistances are joined together and connected to one side of the auto speed control motor. Positive battery is connected to the left hand contact of the relay. One side of the motor field is connected to negative battery and the other side to the right hand contact of the relay. Assuming that the tongue of the relay is against its left hand contact, positive battery will be applied through the left hand contact and tongue of the relay through the motor armature, right hand resistance and motor field to negative battery as shown in Figure 9. The motor will revolve, in this case, so that the rheostat will decrease resistance and increase the current through the adjusting coils thus increasing the speed of the fork. If the armature of the relay is against its right hand contact negative battery will be applied through the motor field, right hand contact and tongue of the relay through the armature of the motor (in the opposite direction to that when the tongue was against its left hand contact), through the left hand resistance to positive battery. The current flowing oppositely through the motor armature and in the same direction as previously through the field will cause the motor to revolve in the opposite direction,

increasing the rheostat resistance, decreasing the current through the adjusting coils and lowering the speed of the fork. The auto speed control motor is geared to the rheostat so that 3000 revolutions of the motor will rotate the rheostat one revolution. Therefore a large number of revolutions of the motor will cause only a slight displacement of the rheostat. Since the auto speed control relay follows the holding relay it should be noted that the current through the auto speed control motor is continually being reversed and that the rheostat will revolve first in one direction and then in the other. The purpose of the adjusting coils is to take care of slight changes in the fork speed which may cause slight speed changes in the receiving rotary. If the correction signals come in regularly the auto speed control motor is reversed regularly, and the rheostat remains practically at a fixed point. If the speed difference between the two stations is so great that correction is on for a considerable time, the auto speed control motor will continue to rotate until the current through the adjusting coils brings the speed of the fork back to such value as to make the correction come in at regular intervals.

ORIENTATION

Orientation or the positioning of the closed intervals of the selector contacts on the receiving distributor with respect to the distant station's transmitted impulses, so that the mid portion of the transmitted impulse will be received at the time of this interval, is determined experimentally. It is done by moving the correcting contacts with reference to the receiving contacts.

From the explanation of the correction circuit it is to be noted that the receiving distributor cam cylinder will oscillate between two limits, one slightly ahead and the other slightly behind the transmitting distributor cam cylinder position. This is due to the fact that normally with the corrector off, the receiving distributor cam cylinder is running slightly slower than the transmitting distributor cam cylinder and when the corrector magnet is energized, the receiving distributor is running slightly faster than the transmitting distributor.

Condition X in Figure 10 shows a pair of correcting intervals a and b, so positioned that the middle point of a closed interval of the receiving selector contact S is in line with the middle point of ab. The solid line from A to B represents the received line impulses when the receiving distributor cam cylinder is in exact synchronism with the transmitting distributor cam cylinder. Since the receiving distributor is set to run slightly slower than the transmitting distributor with correction off, the condition shown by the dotted line A' to B' will presently exist. Under this condition the corrector magnet will be energized and the speed of the receiving distributor increased until it attains that of the transmitting distributor or slightly greater. In the latter case, the relationship of the line signal will assume the position A" to B". When this condition is reached, the corrector magnet will be de-energized, the speed of the receiving distributor reduced and the line signal will gradually move to the position shown by the dotted line A'B'. Thus the closed interval of the selector contacts will oscillate with reference to the line impulse between the positions A' and A".

Referring to condition Y in Figure 10 it is assumed that the correcting contacts have been moved to the left to the position shown. At the

instant the contacts are moved to the left, the selector cam contacts S will of course be closed in advance. This is the same condition that would exist if the receiving cam cylinder had gotten ahead of the line impulse AB. In this case the correcting mechanism would immediately disconnect the corrector magnets and permit the cam cylinder to fall back so that the corrector intervals a and b would coincide with the received signal shown as a solid line. The cam cylinder would then oscillate between A' and A" as in case X. It should be noted that in Y the selector contact interval S is in such a position that its edge will fall on the edge of the received signal and that a further displacement of the corrector contacts to the left would move the intervals S out of range of the received signal impulses and they would not operate the proper magnets in the printer. This is one limit of the corrector contacts position.

Case Z shows the condition brought about by moving the corrector contacts to the right. In this case the receiving contacts would be retarded and would then oscillate between the two positions A'A" and the interval S would be brought to its other extreme.

If the corrector contacts are first moved to the right until the printer fails to print correctly and then moved in the opposite direction until the printer fails, it is obvious that a position mid-way between these extremes would be the one in which the selector contact closed interval would fall on the middle of the received signal, (as shown in "X"). This is, of course, the best condition for reception.

SYNCHRONIZING

There are two methods of adjusting the speed of receiving distributors. On those receiving distributors equipped with lamps, the speed may be adjusted by timing as explained under "Synchronizing Lamps."

Synchronizing By Count

The following description pertains to the method of adjusting the speed of distributors NOT equipped with synchronizing lamps:

Fig. 11 (A) shows graphically the idle signals (all spacing) of the A and B channels for two complete revolutions of the transmitting distributor cam cylinder. The first four impulses of the A channel are negative and the fifth positive. The first four impulses of the B channel are positive and the fifth negative.

When the receiving distributor is not running at the same speed as the transmitting distributor, the receiving distributor contacts will close out of relation to the corresponding transmitting distributor contacts. The impulses of the idle signals which are being received will not be distributed properly because of the out of phase condition. Instead of the printer remaining idle, letters will be printed or functions will be operated. The sequence in which these letters and functions appear indicate whether the receiving distributor is running faster or slower than the transmitting distributor. Refer to Figure 11 (B).

Assuming that the receiving distributor is running slower than the transmitting distributor, the first out of phase operation of the sequence on the A channel printer will be the carriage return. Instead of distributing the

five A channel impulses to the A channel printer the receiving distributor will set up a circuit for the second, third, fourth and fifth impulses of the A channel and the first of the B channel. Because the fourth selector magnet will receive the fifth impulse (positive) the carriage return will be operated on the A channel printer. The next condition will be that of the third, fourth and fifth A channel impulses and the first and second of the B channel being received on the A channel printer. The third and fourth impulses being received as positive the letter N will be printed. This will be followed by C, K, etc. as shown on Fig. 11(B).

When the receiving distributor is running faster than the transmitting distributor, the same characters will appear on the A channel printer in a reversed sequence.

The number of each of the characters in the cycle recorded on the printer will be an indication of the difference in speed between the transmitting and receiving distributors. The nearer the speed of the receiving distributor is to that of the transmitting distributor, the greater will be the number of each character.

From the foregoing it may be seen that the sequence in which the letters are received will indicate whether the receiving distributor is running faster or slower than the transmitting distributor. Inasmuch as the number of times each letter is printed indicates the speed difference between the distributors, speed may be set by count as explained under "Speed Setting."

Synchronizing Lamps

Two lamps are connected to the printer relay and to two cam contacts on the receiving distributor in such a manner as to cause them to light or become dark in a certain sequence when the receiving distributor is not in exact phase with the transmitting distributor. This sequence will disclose whether the receiving distributor is slower or faster than the transmitting distributor. The duration of time that the lamps remain lighted or unlighted will indicate the amount of speed difference.

Fig. 12 (A) shows a theoretical speed indicating lamp circuit connected to the AC contacts of a transmitting distributor. It may be seen that the two AC cams, when revolving, will cause the positive and negative battery connected to the right and left hand contact springs respectively to be alternately transmitted to the line at a frequency determined by the speed of the distributor. Tracing the printer relay tongue circuit it will be seen that when the tongue is against the left hand contact, battery will be available to both lamps L' and L". Should either of the cam contacts LC' or LC" be closed, the corresponding lamp will be lighted.

Each AC cam has five low and five high portions of equal length. They are assembled on the cam cylinder of the transmitting distributor so that their high and low portions are staggered as shown in Figure 12 (A).

Each LC cam has five indents of approximately one fourth the length of the AC cam indents. They are assembled on the cam cylinder of the receiving distributor so that their indents will allow their respective contacts to close alternately. Fig. 12(B) shows the relationship of the alternating current impulses to the closed LC cam internals.

Fig. 12 (A) shows the transmitting distributor AC circuit sending positive battery to the line, causing the tongue of the printer relay at the receiving station to be moved against the left hand contact, closing the circuit through L' and contact LC'. This same condition is shown graphically in Fig. B at the beginning of impulses 1, 3, and 5 during L' intervals of LC. It should be noted that L' and L" intervals of LC (in phase) receive current during the transmission of the odd numbered or positive impulses when the transmitting and receiving distributors are in phase. Both lamps will therefore be continually lighted.

Speeding up of the receiving distributor would create a condition as shown by LC FAST. Intervals L' and L" occur during the first impulses so that current is supplied to both lamps as in condition LC. During impulse 3 because of the difference in speed interval L' having partially moved out of range of impulse 3 will receive current for a short period only. During impulse 5 interval L' has moved completely out of range and is out, whereas L" is receiving current and is lighted. It may be seen that as the receiving distributor continues to advance in relation to the transmitting distributor there will soon be a period when both lamps are out. This will occur when the intervals L' have advanced into the 2 and 4 impulse intervals. Following the interval when both lamps are out, L' will be lighted by moving into positive intervals again, L" remaining out. The cycle which indicates that the receiving distributor is running at a greater speed than that of the transmitting distributor is as follows: Both lamps L' and L" lighted, both lamps out, L" lighted and L' out.

Slowing down of the receiving distributor will be indicated by a reversed cycle; both lamps lighted, L' lighted and L" out, both lamps out, L" lighted and L' out.

The greater the difference in speed between the transmitting and receiving distributors the faster the lamp cycle will change. therefore the lamps will indicate how to properly set the speed of the receiving distributor.

DISTRIBUTOR TABLES

Refer to diagram #1422 for the theoretical wiring of a typical multiplex distributor table.

For actual wiring diagrams that show detailed wiring and location of equipment, refer to the prints which are supplied with table.

RELAYS

Wiring diagrams showing the internal wiring of the polar relays used on the Teletype Multiplex are supplied with the relays.

LINE RELAY VIBRATING CIRCUIT

Figure 13 shows the theoretical connections of the line relay circuit. In addition to the regular operating windings, these relays are provided with auxiliary windings known as the accelerating windings and opposing windings.

The operating windings are connected to the line in the usual manner. The accelerating windings and opposing windings are connected together and to the condenser and resistances as shown in Figure 13. With this circuit the speed of operation of the relay is greatly increased.

When the tongue reaches the spacing contact a rush of current passes to the condenser through the accelerating windings in such direction as to hold the tongue against the spacing contact. At the same time current flows through the opposing windings in such direction as to tend to move the tongue toward the marking contact, giving an opposing effect to the current in the accelerating and operating windings. The condenser charging current, however, diminishes to zero, while the current through the opposing windings increases to a steady value which will cause the tongue to move towards the marking contact, when the line current diminishes at the moment of reversal.

As soon as the tongue leaves the spacing contact, battery is cut off and the condenser discharges through the accelerating and opposing coils in a direction to assist the motion of the tongue, thus shortening the transit time. When the tongue reaches the marking contact, the same cycle of operations is repeated, the tongue, of course, tending to move in the reverse direction.

FUNCTIONS OF SWITCHES ON THE DISTRIBUTOR TABLE

Transmitter Locking Key

The cam key located on the rear right hand corners of the table top is for the purpose of locking the transmitters when alternating current, idle signals, or letters E are being sent to the line. The transmitter coils are connected to the tongues of the cam key and normally when the cam key is in its rear or operating positions the coils are connected to the transmitter contacts on the distributors. When the key is in its forward or locked position the transmitter magnets are connected to battery through a resistance.

Line Battery and Ground Switch

The two outer levers on the line battery and ground switch when in the left hand or normal position connect the line battery to the transmitters and when to the right, disconnect the line battery. The center lever on this switch is for the purpose of connecting the line to either the transmitting equipment or to ground, through a 300 ohm resistor; the line being connected to the transmitting equipment when the switch is to the left.

Corrector Switch

When the corrector switch is thrown to the left, the corrector magnets on the receiving fork are connected so that the magnets are controlled by the holding relay contacts. When the corrector switch is in its center position the corrector magnets are disconnected from the holding relay contacts, opening the circuit. When the corrector switch is thrown to the right the contacts of the holding relay are short circuited so that battery is permanently applied to the corrector magnets. The left hand position of the corrector switch is the normal operating position, the center position is used when setting the receiving distributor for its slow speed value, and the right hand position for setting it at its fast speed.

E. Switch

The E. switch in its normal left hand position connects the first impulse tongue of the A channel transmitter to the number one cam contact on the transmitting distributor. When the E. switch is in its right hand position, marking (positive battery) is connected permanently to the number one contact on the transmitting distributor. Letter E is then transmitted continuously

to the line and is used as an indicator for phasing as explained under that heading.

Line Switch

When the line switch is in its normal left hand position it connects the line to a winding of the main line relay. In the right hand position the line is connected direct to ground.

Sounder Switch

The sounder switch when in its left or normal position connects the printer relay contacts to the receiving distributor, and in its right hand position connects the printer relay contacts to the sounder.

Condenser Switch

Some tables are equipped with a condenser switch. When this switch is in its left hand normal position it connects the ground to the artificial line condensers. In its right hand position the ground is disconnected.

Phasing Switch

The phasing switch is located on the shelf to the right of the receiving fork. It is used when phasing in order to quickly bring the receiving and transmitting distributor into proper phase relation. The phasing switches on tables not using the auto speed control have wires connected to the left and center terminals only while on those tables which are equipped with the auto speed control all three terminals are used.

Those phasing switches having only two wires connected to them when in their left or normal position connect the A.C. circuit of the rotary to the transformer. When in the middle or right hand position this circuit will be opened allowing the rotary to speed up.

The phasing switches that use three terminals are wired in the auto speed control rheostat and adjusting magnet circuit. When this switch is in its left or normal position the auto speed control rheostat is connected in the adjusting magnet circuit. With the switch in the center position the adjusting magnet circuit is opened, causing the rotary to slow down. With the switch to the right the rheostat is short circuited, causing the rotary to speed up.

Auto Speed Motor Switch

On tables equipped with auto speed control units, an auto speed motor switch is provided on the shelf to the right of the phasing switch. It is used for the purpose of turning the auto speed control unit motor on and off.

OPERATING TABLES

Refer to actual wiring diagram furnished with the table.

Panel box wiring diagram (glued inside of distributor panel box cover) shows the inter-connections between the operating tables and the distributor table.

AUTO STOP CIRCUITS

A means is provided on the operating table for automatically stopping the transmitter by means of raising the auto stop lever. The purpose of the auto stop is to prevent tearing of the tape at times when the operator does not perforate the tape fast enough to supply the transmitter. It also may be used in connection with signalling the distant station.

There are two different auto stop systems in use. One of the systems is used in connection with transmitters equipped with an additional pair of magnets. The other system is used in connection with those transmitters which have operating coils only.

Auto Stop Circuit (For Transmitters with Two Pairs of Magnets).

Normally the auto stop lever is down and its contacts closed (Fig. 14A). It should be assumed that the auto stop lever has been moved upward by the tape or manually. In this case when the transmitter operating contacts are closed battery will flow through the transmitter operating coils and right hand winding of relay M150. The circuit through M149 is open at the auto stop contacts and this relay is therefore not operated. Current will then flow through the tongue and contact of relay M149; through the tongue, contact, and locking winding of relay M150, and through the windings of the transmitter locking coils, thus operating the transmitter locking magnets, and locking the relay M150.

The transmitter locking coils will remain operated until the auto stop contacts are again closed and an impulse is received from the transmitter operating contacts, which will operate relay M149 and disconnect battery from the locking magnets.

It should be noted that the relays operate only when the transmitter operating contacts are closed and that it is impossible to operate the transmitter locking coils or the relays during the time that any of the signal impulses are being transmitted. The transmitter operating coils receive an impulse every time the transmitter operating contact is closed, but due to the fact that the locking coils are holding the transmitter in a locked position it has no effect on the transmitter.

Auto Stop Circuit (For Transmitters with One Pair of Magnets).

Fig. 14B shows the auto stop relay circuit using a transmitter having operating coils only. With the auto stop contacts closed, the transmitter operating impulses from the transmitter operating contacts on the distributor, passing through the right hand contact tongue of the auto stop relay, energize the transmitter magnets. The auto stop relay windings also receive current through the auto stop contacts and left hand contacts of the auto stop relay. The relay is wound differentially and the current is applied so that the windings oppose each other, the relay therefore remaining unoperated.

With the auto stop lever raised (contacts open), current will flow only through the right hand winding of the auto stop relay when the transmitter operating contacts on the distributor are closed. The relay contacts will be pulled up and locked in by battery applied to the left hand contact tongue and

right hand winding. The transmitter coils will be energized continuously by battery applied through the right hand tongue.

When the auto stop contacts are closed again, current from the transmitter operating contacts on the distributor will energize the left hand auto stop relay winding, neutralizing the effect of the right winding, and allow the relay contact tongues to drop back to their normal position.

TEST TABLE

Refer to the Wiring Diagram accompanying the test table for the actual wiring. Figure 15 shows the theoretical circuit of a test table. The two commutators shown are on the test distributor. The two brushes are attached to the same shaft and are continuously rotated by the motor. The short selecting segments and the sixth pulse segment of the outer ring of the receiving disc are connected to the five selecting magnets and the 6th pulse magnet of the printer. The first four segments of the inner ring are connected to the left hand contact of the relay and the fifth to the right hand contact.

The five segments in the outer ring of the transmitter disc are connected to the five tongues of the transmitter. The first, second, third and fourth marking and the fifth spacing contact are connected in a group and the first, second, third, and fourth spacing and fifth marking transmitter contacts are connected in another group. Each group is connected to one of the windings of the polar relay. The inner ring on the transmitting disc is divided into two segments, the shorter one being connected to the transmitter magnet and the other to battery.

If the first tongue of the transmitter is against its spacing contact battery will flow from the inner ring on the transmitting disc, to the first segment when the brush passes over it, through the tongue and spacing contact of the transmitter, through the winding of the relay to negative battery. This will cause the relay tongue to move against its right hand contact. The receiving brush will at the same time be passing over the first receiving segment, but since the relay tongue is against its right hand contact no current will flow through the first selector magnet due to the fact that the inner segment corresponding to the first selecting segment is connected to the left hand contact on the relay. If, however, the first pulse is marking, the relay will move its tongue against the left hand contact and as the receiving brush passes over the first selecting magnet segment battery will be connected to this magnet. In this way, the receiving printer is operated through the distributor. When the receiving brush passes on to the 6th pulse segment, battery is connected to the 6th pulse magnet. On the transmitting disc, the transmitting brush passes on to the transmitter operating segment after the transmission of the five impulses and the transmitter is operated.

The auto control circuits used on test tables are identical with those of the operating tables.

TEST DISTRIBUTOR

Refer to actual Wiring Diagram supplied with the distributor.

STARTING A TELETYPE MULTIPLEX CIRCUIT

It is assumed that all the units on the distributor and operating tables are properly adjusted.

Refer to the following Teletype adjustments and description bulletins:

Transmitter Unit Adjustments (For those transmitters using one pair of magnets)	No. 103
Description and Adjustments of the Tape Perforator	108
Description of the Typebar Page Printer (Model 12)	109
Adjustments Page Typebar Printer (Model 12)	110
Transmitter Unit Adjustments (For those transmitters using two pairs of magnets)	113
Adjustments of Multiplex Transmitting and Receiving Forks- Automatic Speed Control - Transmitting and Receiving Distributors	116
Care and Adjustment of Teletype Polar Relays	118
Care and Adjustment of Polar Relays (Teletype RY20-W.E. 215A)	120
Multiplex Auto Control Relay Adjustments (for those units using two relays)	121
Description and Adjustments Multiplex Tape Printer	139
Multiplex Auto Control Relay Adjustments (for those units using one relay)	145

Relay Contact Tongue Travels

The contact tongue travel of the relays is as follows:

Line Relay:	.004"	Corrector Control Relay:	.004"
Printer Relay:	.004"	Switch Relay	.006"
Corrector Relay:	.012"	Holding Relay	.012"
Auto-speed Relay:	.012		

Operating Table Switches

The printer switches on all operating tables should be turned OFF.

Distributor Table Switches

When making a resistance and static balance with the distant station the sounder and pole-changer key switches should be thrown to the right so that Morse signals may be sent and received over the line. For detailed explanation of line balancing refer to Teletype Bulletin 131, Duplex Printer Operation.

Fork Weights

The weights on the transmitting fork should be set according to the following table:

<u>Approximate words per minute</u>	<u>Weights</u>	<u>Distance from stop</u>
33	1 Large, 2 Small	Against
37	1 Large, 1 Small	Against
41	1 Large	Against
45	2 Small	2"
53	2 Small	Against
55	1 Small	1-3/4"
61	1 Small	Against

The weights on the receiving forks should be set approximately 1/4" farther out from the stops than those on the transmitting forks.

Starting Distributors and Forks

The transmitting and receiving distributor switches should be turned on and the forks set into vibration. Turn the transmitting distributor motor rheostat to its extreme clockwise position. Then slowly turn the rheostat counter-clockwise until the indicating lamp stops flickering and lights at a constant brilliancy. With the rheostat in this position the motor speed has been reduced to that of the fork. The receiving distributor motor rheostat should be adjusted in the same manner.

A.C. Balance

In order to transmit A.C. to the line for refining balance or lining up repeaters the switch on the transmitting distributor should be moved to the rear, the transmitter locking cam key forward and the pole-changer key switch to the left.

The jack on the top of the distributor table may be used in connection with one of a number of line balancing indicating devices. The jack is normally open circuited and connected across the coils of the line relay. An audible line balancing indicator may be made up of a telephone receiver in series with 130 ohms resistance and an 0.1 mf condenser. When plugged into the jack a perfect line balance will be indicated by the elimination of A.C. reversal sounds in the receiver.

SPEED SETTING

After the line has been balanced and the repeaters lined up, the two ends of the circuit should be synchronized. As previously explained, the receiving distributor speed is set so that it will run slightly slower than the transmitting distributor when the corrector magnet circuit is open and slightly faster when the corrector circuit is closed. The speed difference between the two distributors is ascertained by either one of the following methods:

Speed Setting by Count

Place the corrector switch lever in the center position (OFF). Move the adjustable weights to a position approximately midway between their extreme forward and rear positions. The distant station should run "IDLE". The A channel printer should now be turned on and the receiving fork weights should be set so that the sequence of letters printed show the speed to be slow (should the sequence of letters indicate fast speed, move the weights forward). See Figure 11. The final position of the weights should be such that approximately 100 of each letter are printed before the change to the next letter occurs (move the weights forward if more than 100 letters are printed or to the rear if less than 100 letters are printed). The adjustable weights may be used for the purpose of attaining the final adjustment without stopping the fork.

Place the corrector switch lever in the right hand position (steady correction). This will increase the speed of the receiving distributor and reverse the sequence in which the letters appear on the printer. If the corrector magnets are properly adjusted, approximately 75 of each letter will be printed. If more than 75 of each letter are printed insufficient correction

is indicated and the corrector magnet pole pieces should be moved nearer to the fork tines. If less than 75 of each letter are printed, the correction is too great and the pole pieces should be moved away from the fork tines. The corrector magnet pole pieces, when once properly set should not require further adjustment unless the speed of the circuit has been changed.

Place the corrector switch lever to the left (normal). The distributor will now hold synchronism. Refinement of the speed should be made while observing the action of the corrector meter. If the meter needle favors the right hand position (correction on) move the adjustable weights slightly to the rear. If the needle favors the zero position (correction off) move the adjustable weights slightly forward. When the corrector meter needle is operating so that it remains on either side for an equal period of time, the speed is properly adjusted.

Speed Setting with Synchronizing Lamps

Turn the auto speed control motor OFF. Place the corrector switch lever in the center position (Off). Position the auto speed control rheostat indicator so that it points vertically upward. The distant station should send A.C. The receiving fork weights should be set so that the synchronizing lamps on the receiving distributor indicate that speed is slow. This is indicated by the front lamp lighting before the rear lamp after any dark (both lamps out) interval. Should the rear lamp light after any dark interval the speed is fast and the weights should be moved forward. The receiving fork weights should be finally set so that the interval from dark to dark or light to light of either lamp is from 60 to 90 seconds. If the time interval is more than 90 seconds, move the weights forward and to the rear if the time interval is less than 60 seconds. When the receiving fork weights have been adjusted so that the lamp interval is near the required time, the auto speed control rheostat may be used to make the final adjustment without stopping the fork. The auto speed control rheostat knob should be turned clockwise to decrease the interval and counter-clockwise to increase the interval. If when the final adjustment with the auto speed control rheostat is made, the indicator is more than 45° from its vertical position, it will be necessary to readjust the weights.

Place the corrector switch to the right (steady correction). This will increase the speed and reverse the sequence in which the lamps are lighted (the rear lamp lighting first after any dark interval). Adjust the corrector magnet rheostat so that the interval from dark to dark or light to light of either lamp is from 25 to 35 seconds. If the interval is greater than 35 seconds turn the rheostat in a clockwise direction and in a counter-clockwise direction if less than 25 seconds. If the rheostat is turned to its extreme clockwise position and the lamp interval still exceeds 35 seconds it will be necessary to move the corrector magnet pole pieces closer to the fork tines. If, however, the rheostat is turned to its extreme counter-clockwise position and the interval is less than 25 seconds it will be necessary to move the corrector magnet pole pieces away from the fork tines.

Place the corrector switch to the left (normal). The distributor will now hold speed. Refinement of the speed should be made while observing the action of the corrector meter. If the meter needle favors the right hand

position (correction on) turn the auto speed control rheostat counter-clockwise. If the needle favors the zero position (correction off) turn the auto speed control rheostat clockwise. When the corrector meter needle is operating so that it remains on either side for an equal period of time the speed is properly adjusted.

Phasing

After the speed of the receiving distributor has been properly set, it is necessary to bring it into phase with the transmitting distributor. Set the range finder so that the indicator is on 18. The distant station should send "E". The two stations are in phase when the letter "E" is received on the A channel printer. As previously explained, there are two methods in which phasing switches are wired. They are used as follows:

On those tables which are not equipped with auto speed control, if the letter "E" is not being printed when the distant station is sending E, the phasing switch should be thrown to the right momentarily. This will cause the receiving distributor cam cylinder to advance. This should be repeated until the letter E appears on the printer. The switch should then be thrown to the normal left hand position.

On those tables equipped with the auto speed control, if the letters printed indicate that the receiving distributor cam cylinder should be slowed down, the phasing switch should be placed in the center position. See Fig. 16 for phasing cycle. If the distributor speed should be increased, the switch should be thrown to the right until the letter E is printed when it should be returned to its left hand normal position.

Orientation Setting

It is now required to refine the phase relation between the two ends of the line, that is, to bring the receiving cam cylinder in such a position so that it is closing a contact when the best part of the transmitted signal is received. The distant station is asked to send RY - they will throw their transmitter locking key toward the rear or operating position and run an RY tape through the transmitter on the first channel. The range finder on the receiving distributor is moved slowly to the right until the printer fails to print RY. The position of the indicator is noted and the range finder moved slowly to the left until the printer does not print RY correctly and the position of the indicator again noted. The indicator is then set midway between the two extremes found.

Final Test

After the range finder has been set in its best position, the switches on both operating tables should be turned on, all switches on the distributor table are moved to the left, and the distant end asked for test. They will then send a test tape through the transmitters on all channels. When both ends are receiving test copy correctly on all channels the circuit is ready for business.

THREE-CHANNEL MULTIPLEX

Transmitting

To compensate for slight irregularities in the adjustments of the impulse contacts of the three channel distributor, the alternate impulses pass through a pair of definition contacts before going to the line. This is accomplished on the 2 channel distributor by the "A.C." contacts. However, on the 3 channel distributor as the fifteen impulse contacts of the distributor constitute an odd number, only fourteen pulses may be defined by the pair of definition contacts. One sending pulse (the 5th on C) is not defined and passes directly from the sending contact to the line.

There are sixteen cam cuts for the "A.C." transmitting contacts which give the signals for balancing a slightly higher frequency than the regular operating signals.

To provide reversals for correction when running idle, the contacts of the three transmitters are connected as follows:- The 1st, 2nd, 3rd, 4th on "A", the 5th on "B" and the 1st, 2nd, 3rd, 4th on "C" channel are connected to positive battery for marking and negative for spacing. The 1st, 2nd, 3rd, 4th on "B", the 5th on "A", and the 5th on "C" are connected to negative battery for marking and positive for spacing.

Receiving

To rectify the reversed transmitting impulses, the printer operating pulses are received from the printer relay as follows:- The 1st, 2nd, 3rd, 4th on 'A', the 5th on 'B', and the 1st, 2nd, 3rd, 4th on 'C', are connected to the left-hand or spacing side of the relay.

The 1st, 2nd, 3rd, 4th on 'B', the 5th on 'A' and the 5th on 'C' are connected to the right-hand or marking side of the relay.

Speed Setting

The speed of the receiving distributor should be adjusted so that with the corrector switch in the 'OFF' position 65 characters are printed before a change in the character occurs, and the sequence of characters show that the receiving distributor is running slower than the sending. With the corrector switch in the 'ON' position, 35 characters should be printed before a change occurs, and their sequence is reversed.

The adjustment of the distributor speed should be made by actual count of the characters received on the printer.

It is necessary that the slow speed adjustment, with the corrector 'OFF', be made FIRST, and as accurately as possible.

The fast speed, with the corrector 'ON' should then be made by adjusting the corrector magnet pole pieces. Note that it is useless to check the corrector magnet adjustment until the slow speed has been properly matched.

While matching speed, the fact should be kept in mind that the characters, as received on the printer, should change from one letter to another, with some degree of regularity. Should the sequence of characters change, and then revert to the original sequence it is an indication of uneven speed regulation and can usually be traced to the fork contacts or distributor.

After matching speed as outlined above the corrector switch should be thrown to the operating position and the corrector meter observed. The indicator should work evenly. In general, the speed regulation should remain as it was matched. At this point, any unevenness in the operation of the corrector should be followed up and corrected in the corrector circuit relays and distributor contacts.

Orientation Setting

The same care should be exercised in setting the range finder, as in matching speed. The approved method of determining the best point of the printing range, is to have the distant terminal lock the letter G, in the 'A' and 'C' channel transmitters, and let the 'B' transmitter run LETTERS.

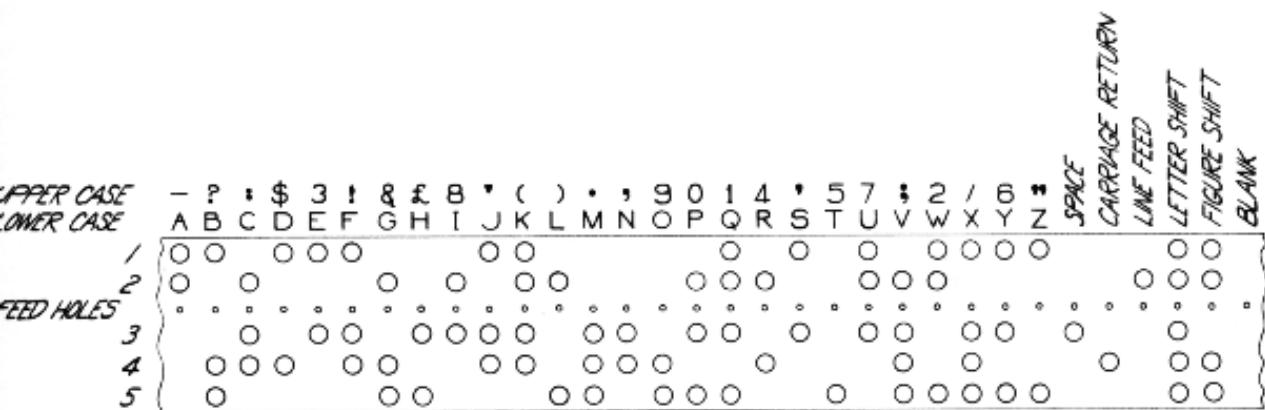

FIGURE-1

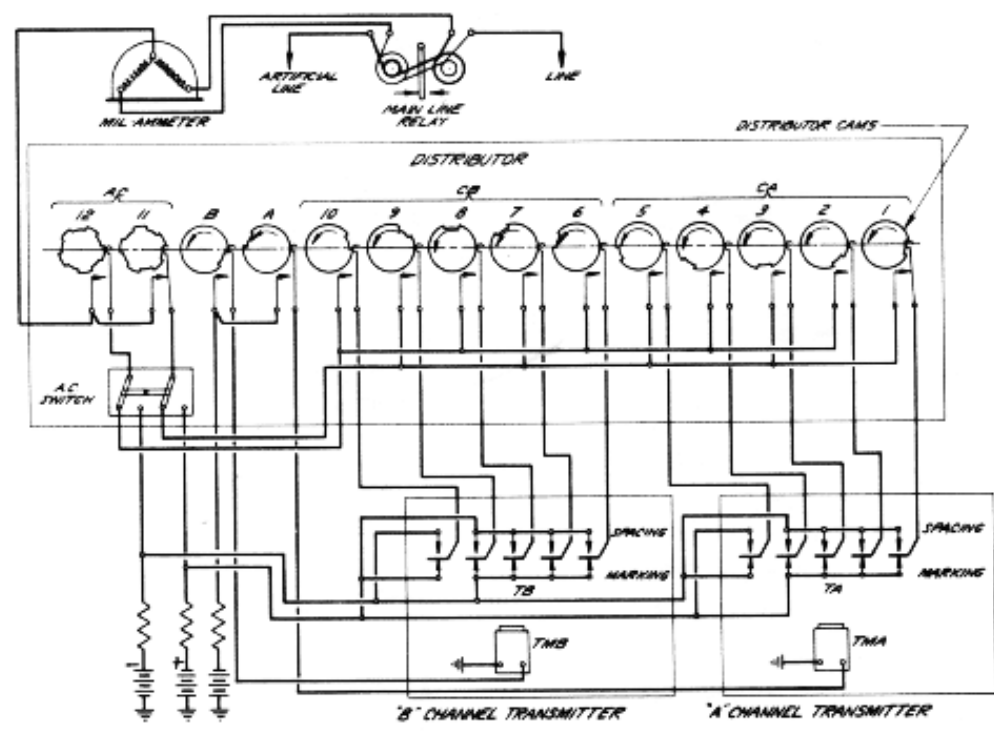
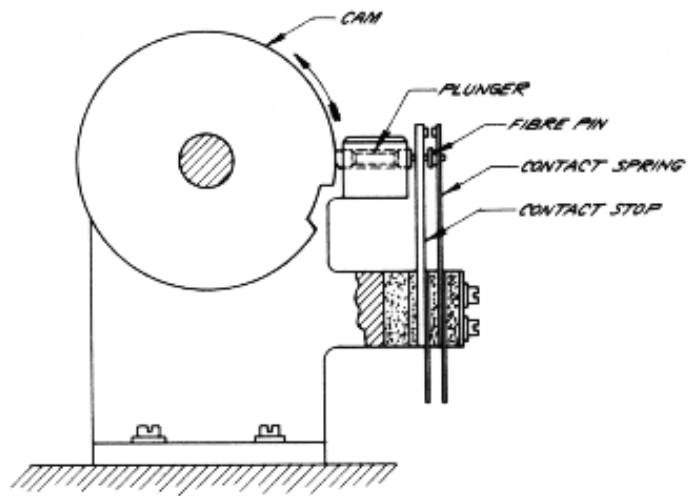
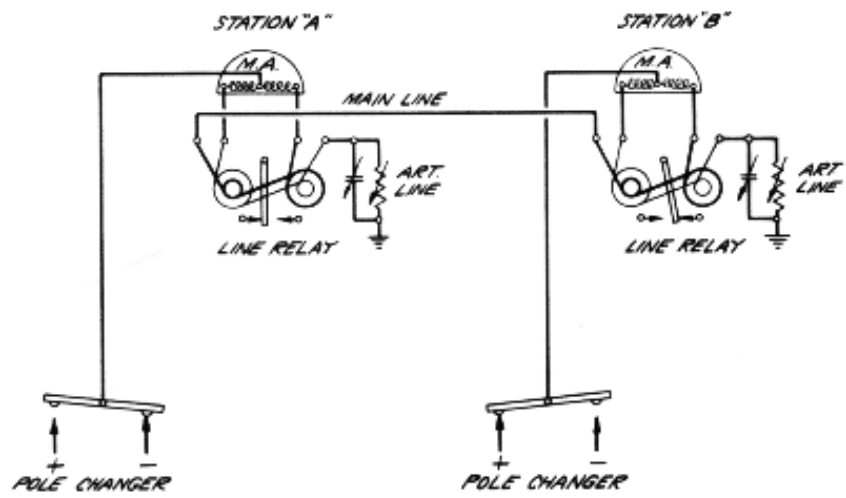

FIGURE-2



DISTRIBUTOR CONTACT MECHANISM
FIGURE-3



THEORETICAL DUPLEX CIRCUIT
FIGURE-4

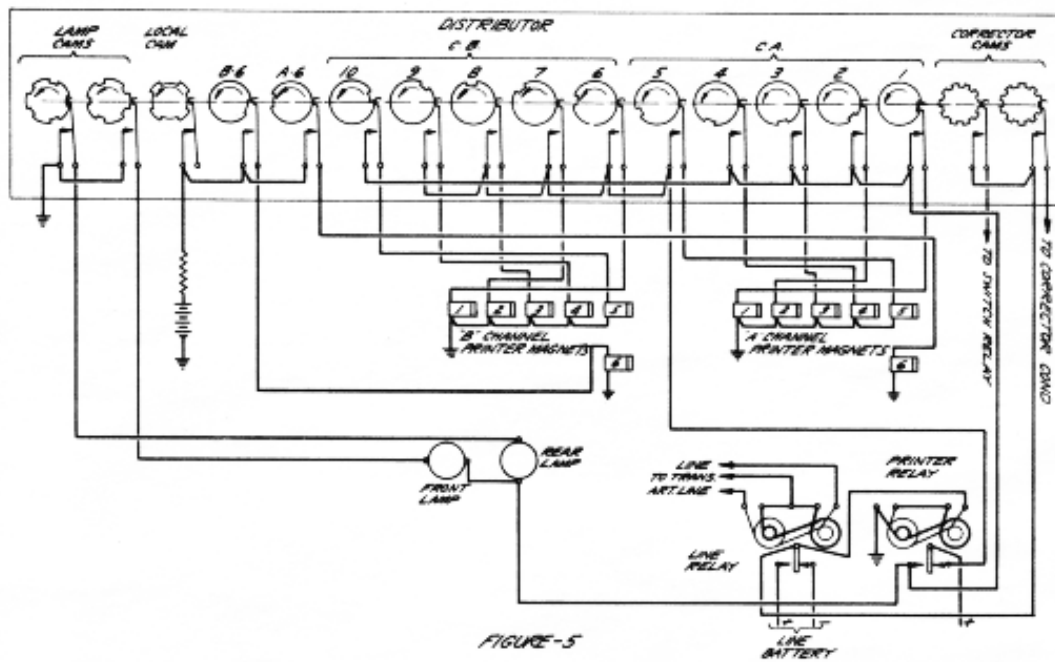

FIGURE-5

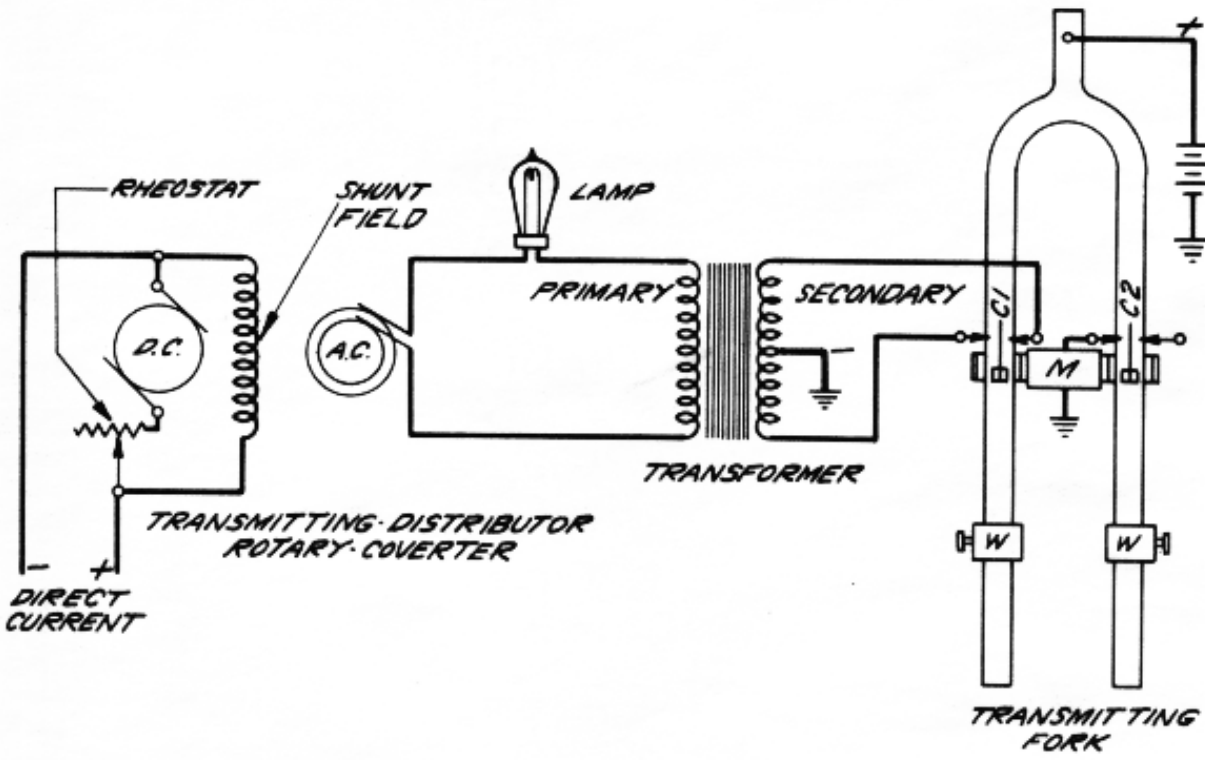

FIGURE-6

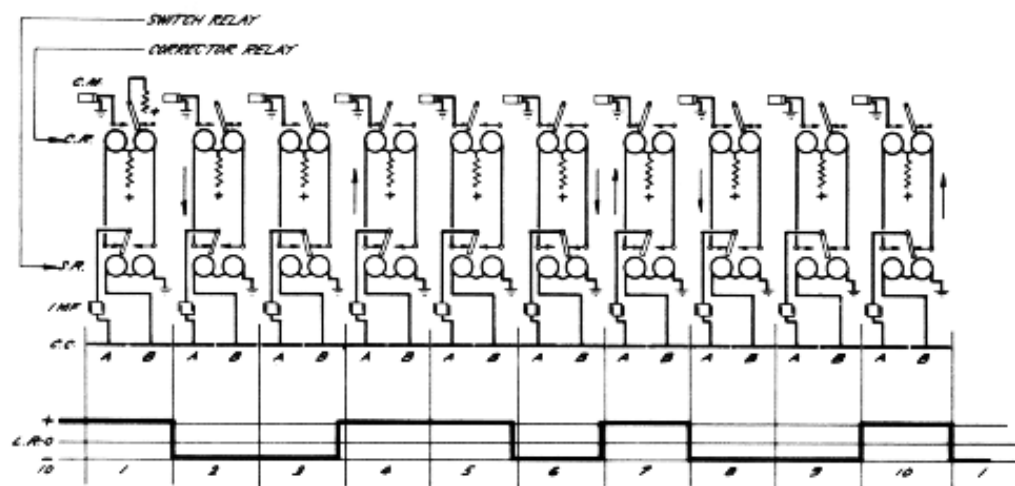

FIGURE 7

CORRECTION OFF (C R tongue against right contact)

B interval does not reverse polarity and is + .
 S R tongue against left contact. A of next impulse (-). Condenser charges thru C R to move C R tongue to right. (See impulse intervals #7 & #8).

OR

B interval does not reverse polarity and is - .
 S R tongue against right contact. A of next impulse (+). Condenser discharges thru C R to hold (or move) C R tongue to right. (See impulse intervals #9 & #10).

CORRECTION ON (C R tongue against left contact)

B reverses from - to + . S R tongue moves to left. A of next impulse (+) condenser discharges thru C R to move C R tongue to left. (See impulse intervals #3 & #4).

OR

B reverses from + to - . S R tongue moves to right. A of next impulse (-). Condenser charges thru C R to hold (or move) C R tongue to left. (See impulse intervals #5 & #6).

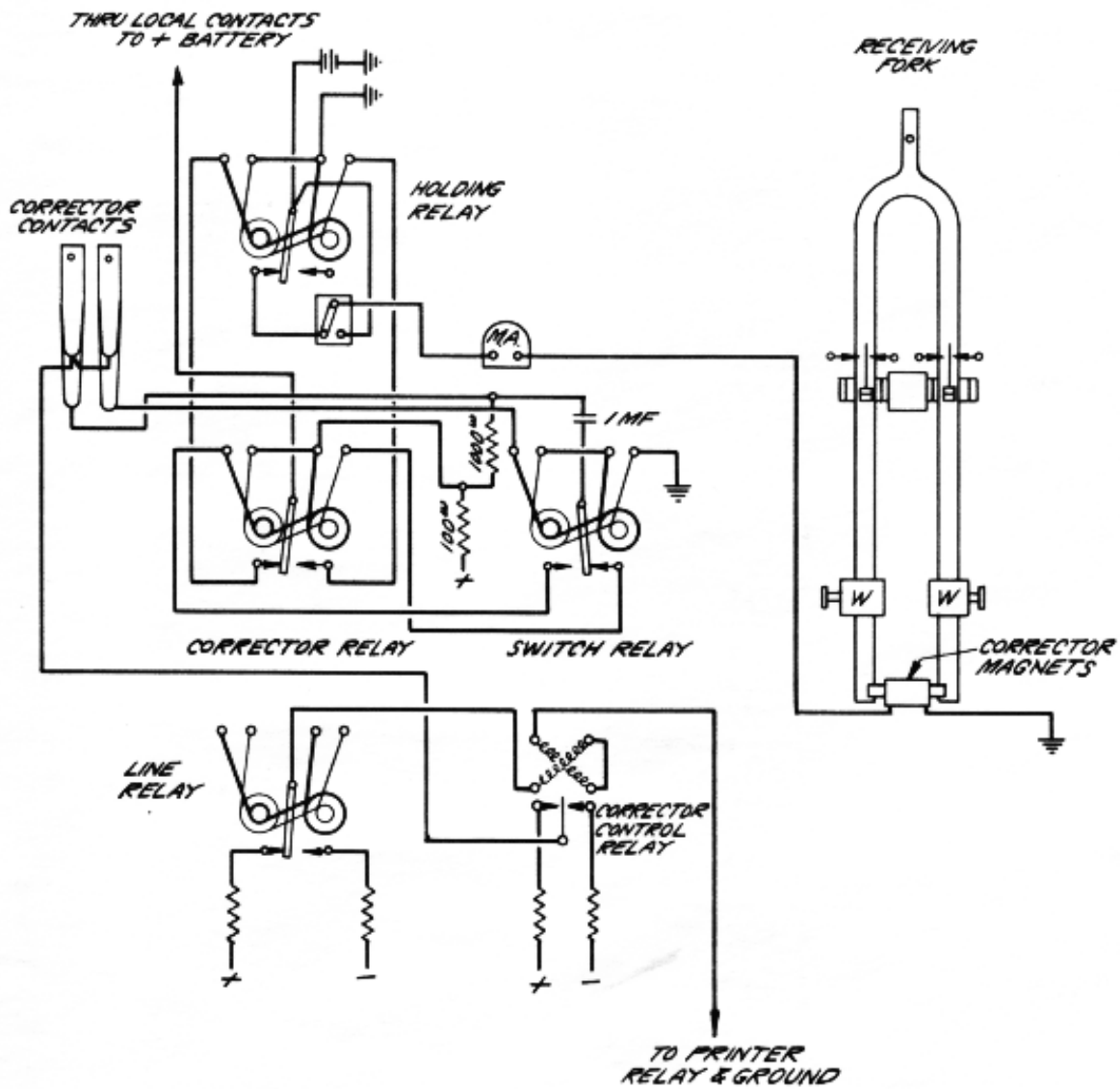

FIGURE - 8

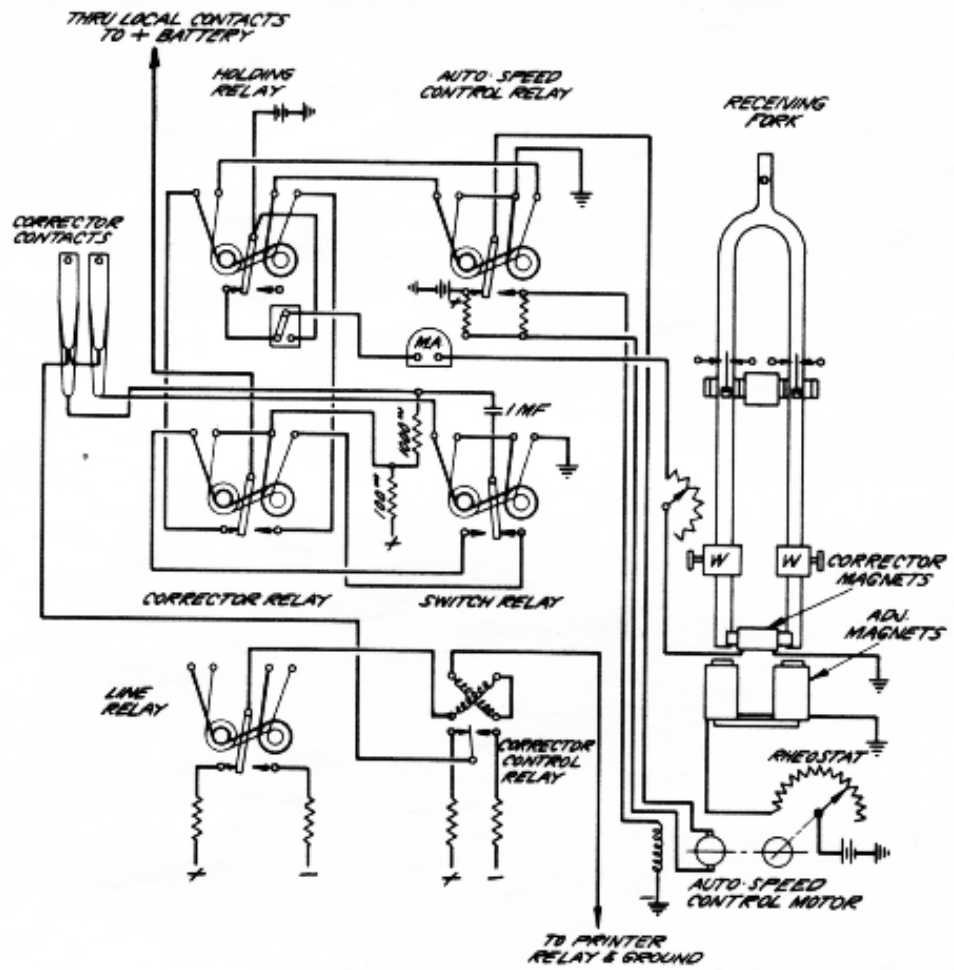

FIGURE-9

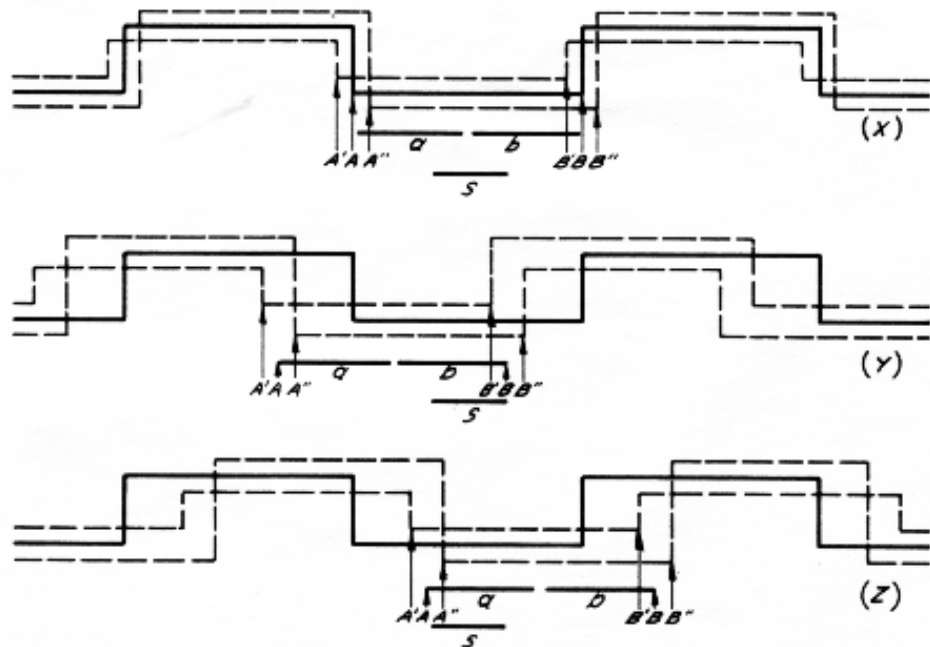
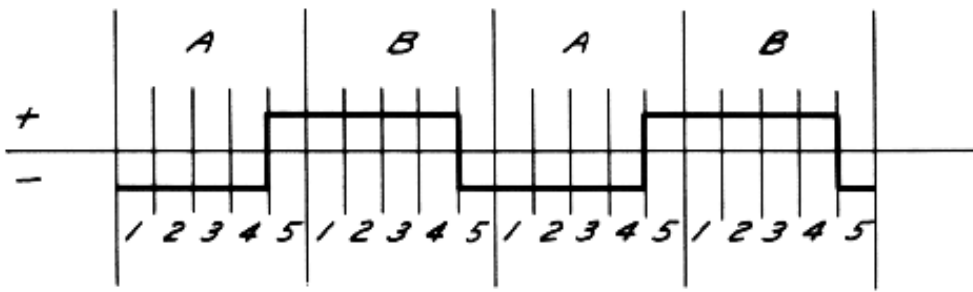
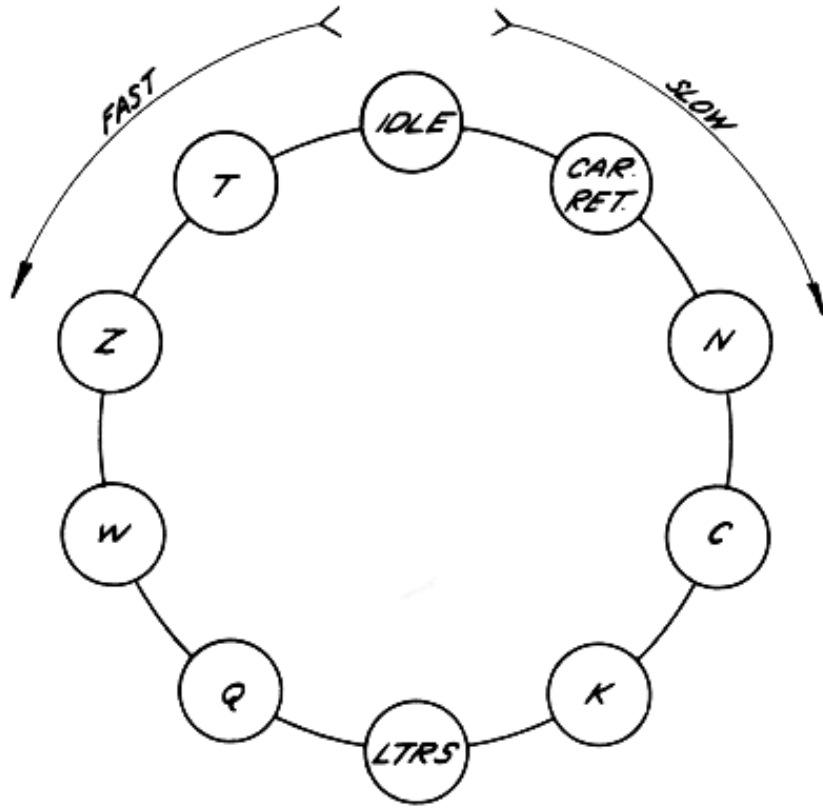

FIGURE-10



(A)



(B)

FIGURE-11

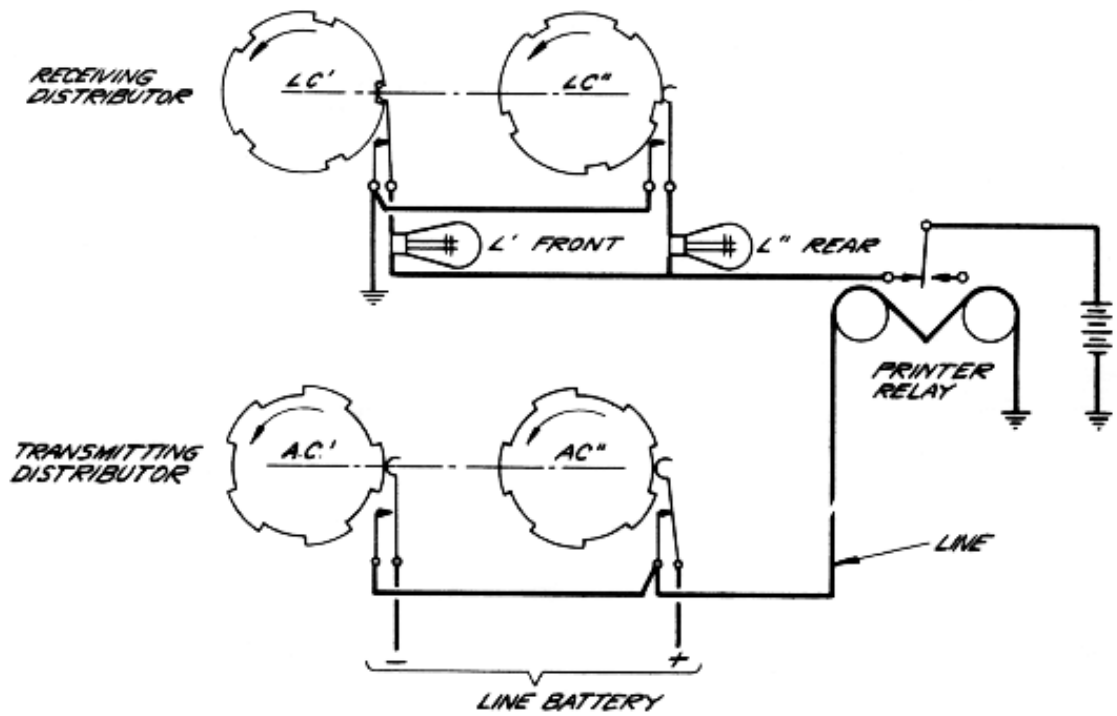

(A)

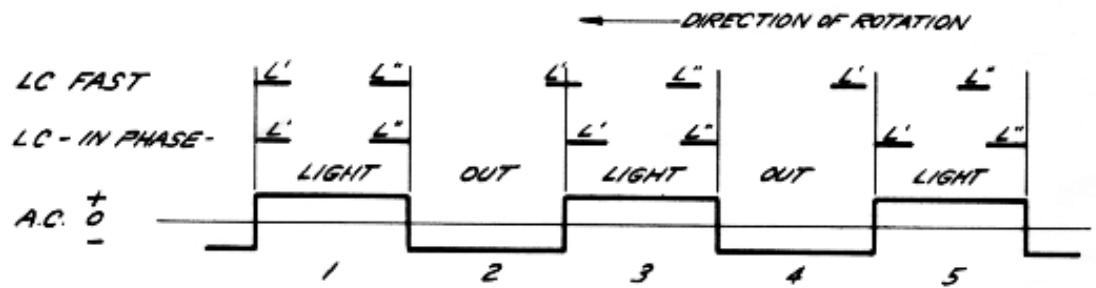

(B)

FIGURE-12

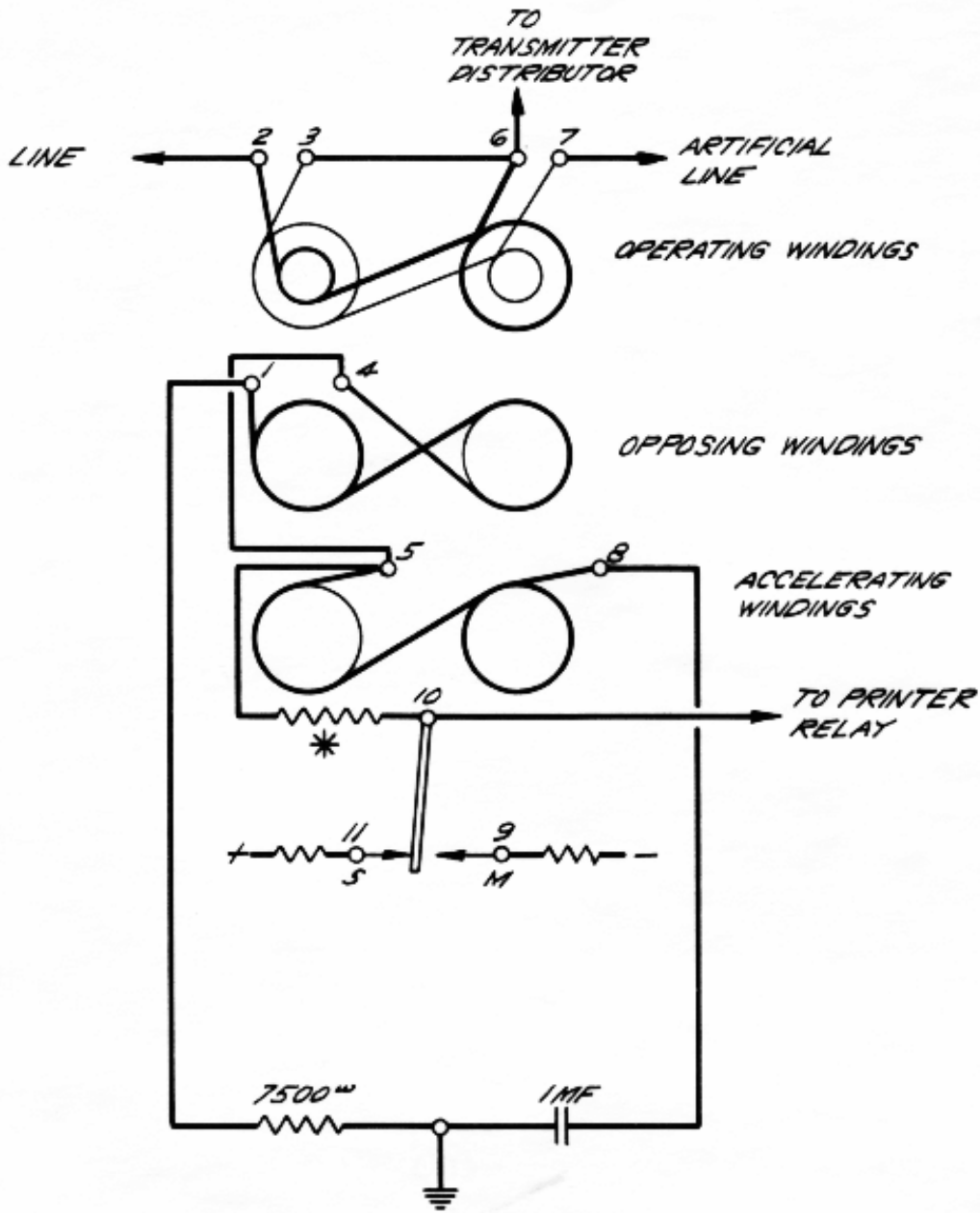

NUMBERS OF TERMINALS REFER TO THOSE ON DIAGRAM # 376.

* - 3000^w WHEN 160 V. LINE RELAY CONTACT BATT. IS USED.
 - 1000^w " 110 V. " " " " " " " " " "

FIGURE-13

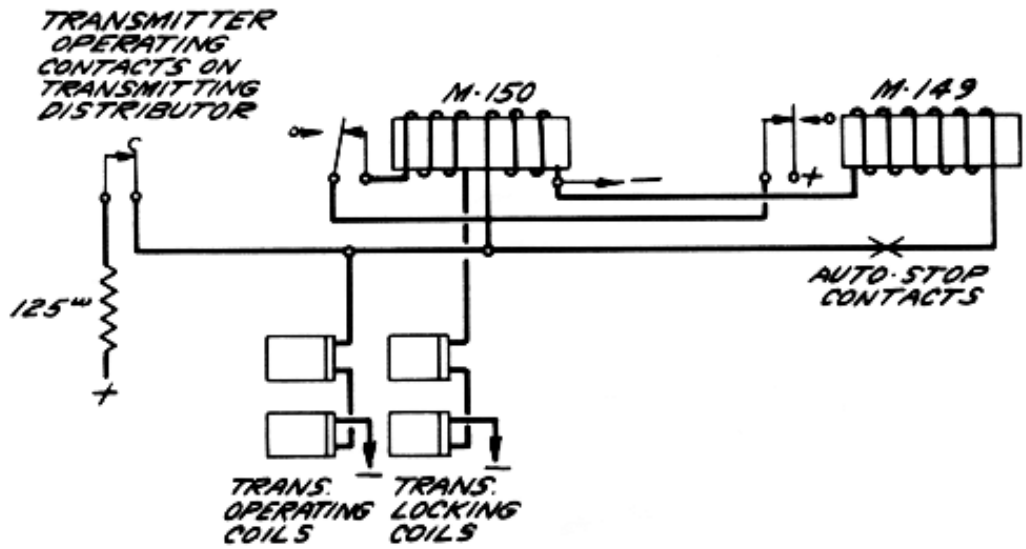

(A)

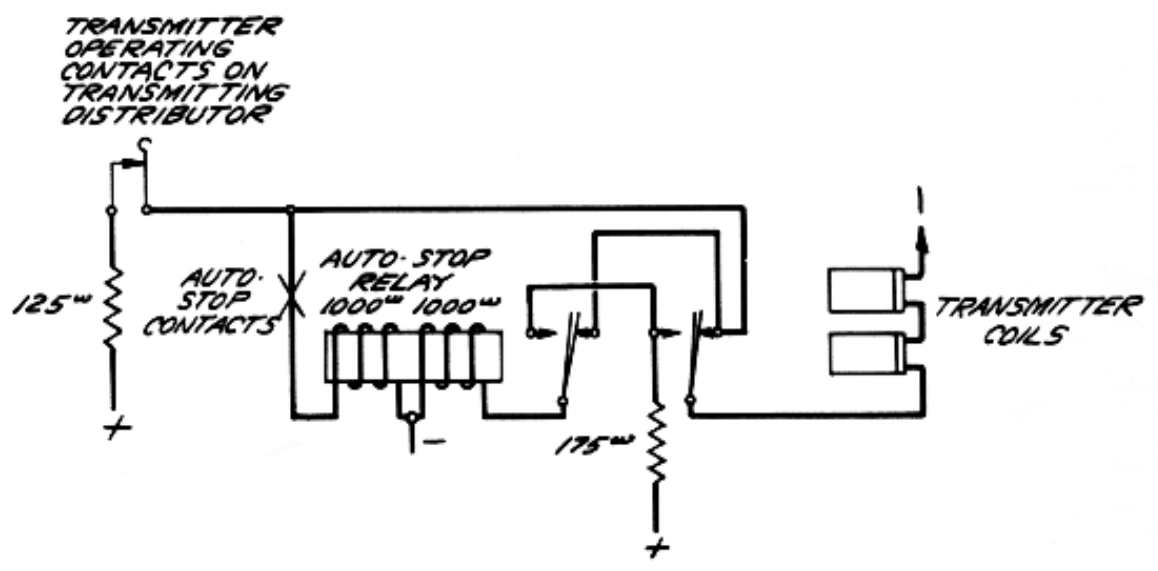

(B)

FIGURE-14

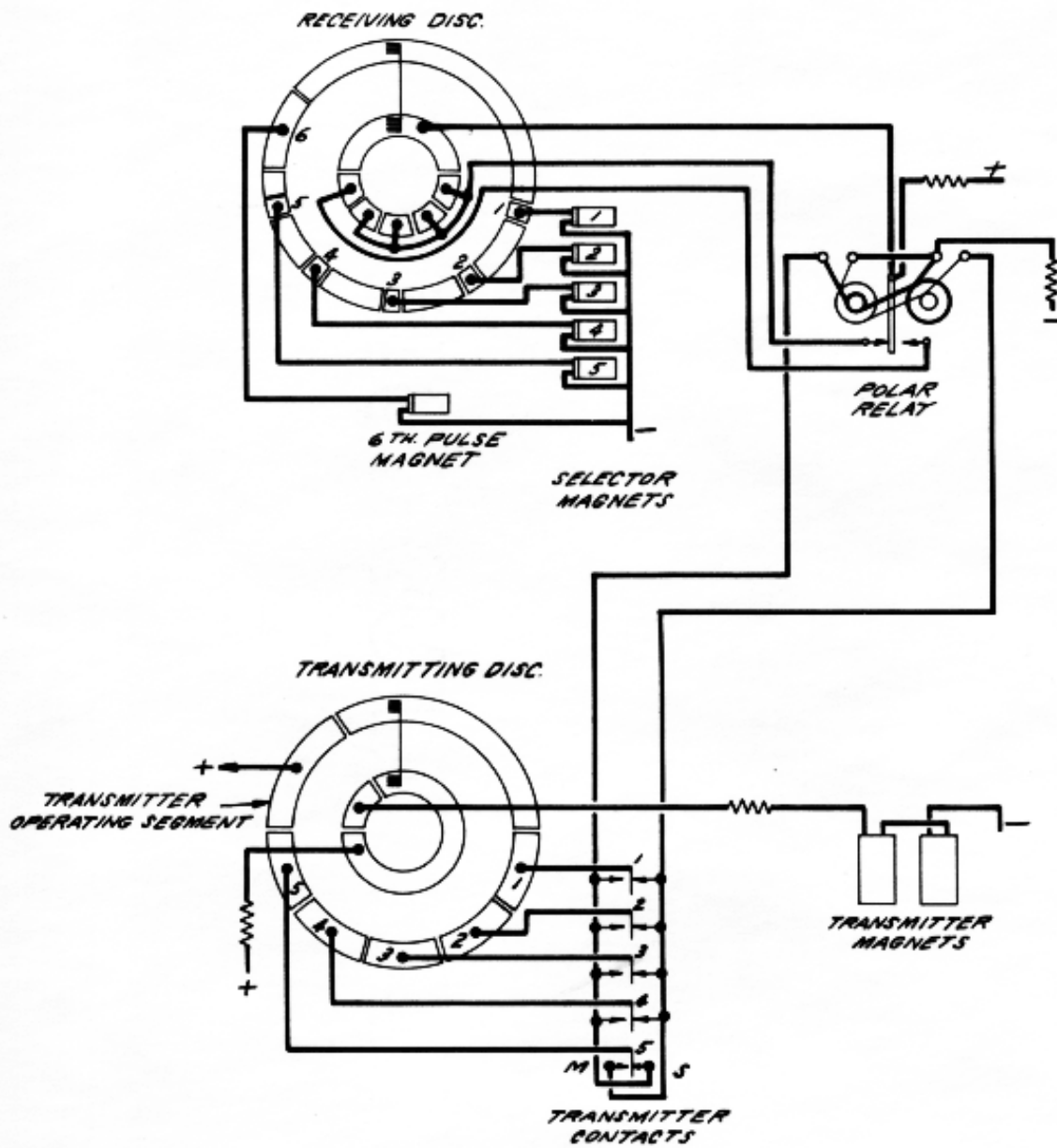

FIGURE 15

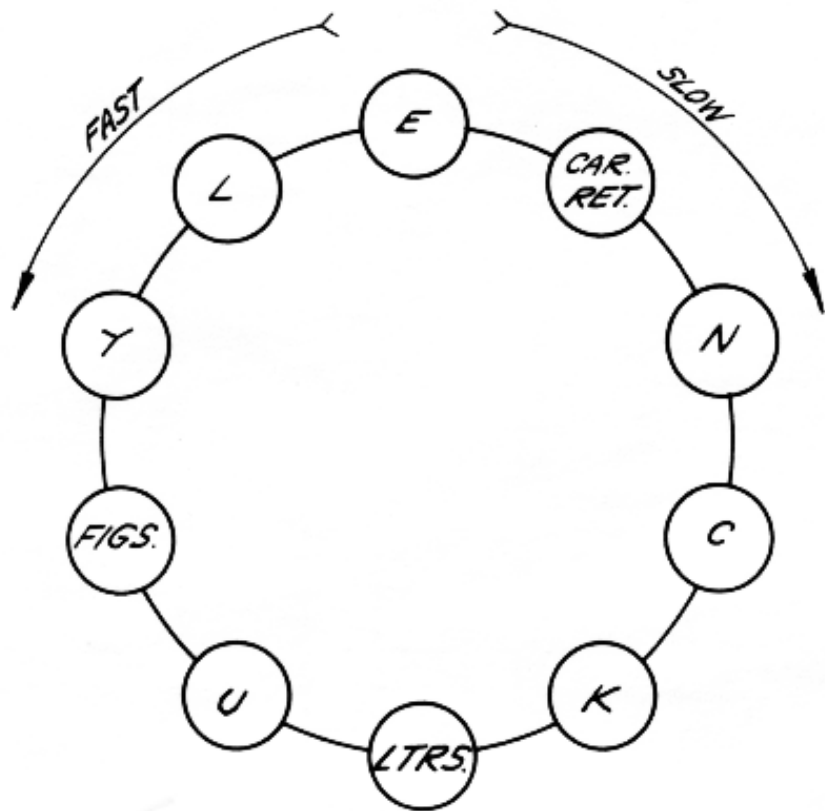
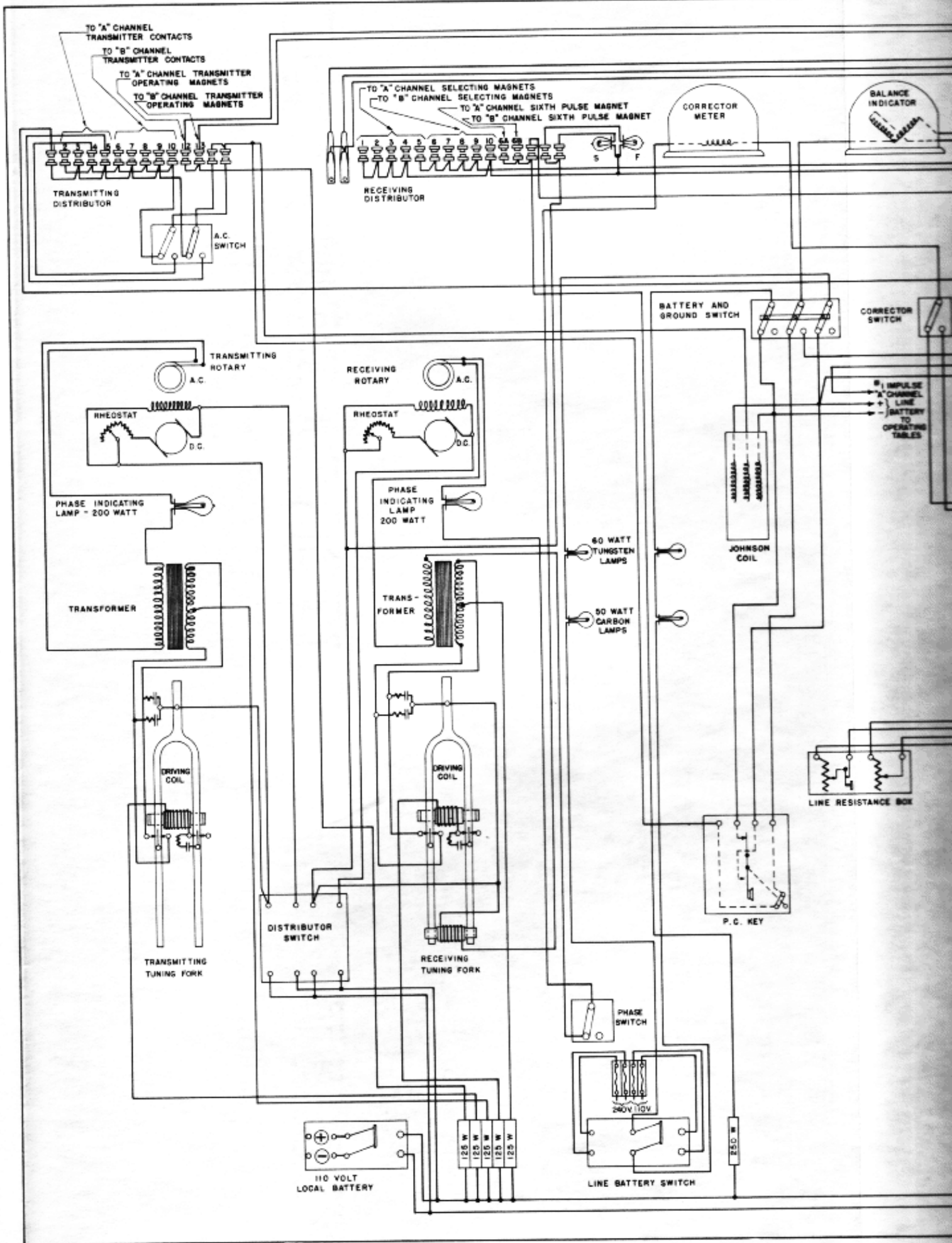
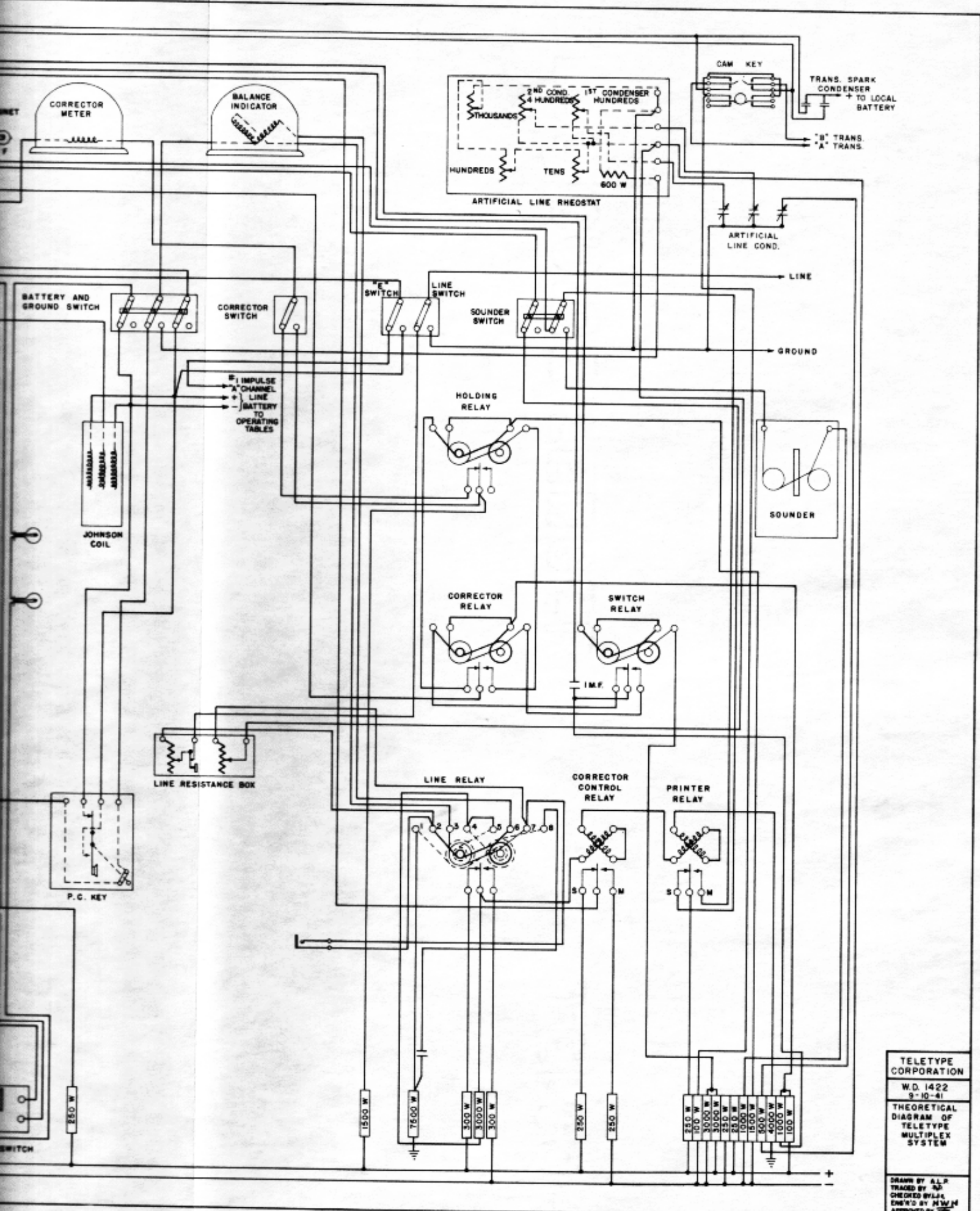

FIGURE-16





TELETYPE CORPORATION
 W.D. 1422
 9-10-41
 THEORETICAL DIAGRAM OF TELETYPE MULTIPLEX SYSTEM
 DRAWN BY A.L.P.
 TRACED BY S.P.
 CHECKED BY L.S.
 ENG'D BY M.W.M.
 APPROVED BY