

Bulletin No. 112
(POSTAL W.S.S.)
FEBRUARY, 1926.

MORKRUM-KLEINSCHMIDT

PRINTING TELEGRAPH SYSTEMS

*MORKRUM MULTIPLEX
PRINTING TELEGRAPH SYSTEM*

TELETYPE

MORKRUM-KLEINSCHMIDT CORPORATION
CHICAGO, U. S. A.

Bulletin No. 112
(POSTAL W.S.S)
FEBRUARY, 1926.

MORKRUM-KLEINSCHMIDT

PRINTING TELEGRAPH SYSTEMS

*MORKRUM MULTIPLEX
PRINTING TELEGRAPH SYSTEM*

TELETYPE

MORKRUM-KLEINSCHMIDT CORPORATION
CHICAGO, U. S. A.

MORKRUM MULTIPLEX PRINTING TELEGRAPH SYSTEM

CONTENTS

Description	Page.
Introduction	1.
Signalling Code.	1.
Transmission	2.
Duplex Circuit	3.
Reception.	5.
Speed Control.	5.
Transmitting Distributor Motor Control	6.
Receiving Distributor Motor Control.	8.
Corrector and Adjusting Magnets.	8.
Synchronism General.	8.
Principal of Synchronizing Circuit	9.
Correction Signals When Tape Transmitters Idle	13.
Complete Correction Circuit.	15.
Automatic Speed Control Unit	16.
Orientation.	17.
Synchronizing Lamps.	19.
Distributor Table---Wiring	23.
Polar Relays---Wiring.	23.
Transmitter Locking Key.	24.
Line Battery and Ground Switch	24.
Corrector Switch	25.
R. Switch.	25.
Sounder Switch	25.

COPYRIGHT 1923 MORKRUM COMPANY

Condenser and Line Switch	26.
Phasing Switch.	26.
Automatic Speed Control Motor Switch	26.
Operating Table Power Switch	26.
Transmitting Distributor	27.
Transmitting Distrubutor ---Wiring	28.
A.C. Contacts	28.
Receiving Distributor	29.
Receiving Distributor---Wiring	32.
Transmitting Forks---Wiring	33.
Receiving Forks---Wiring	33.
Automatic Speed Control Unit---Wiring.	34.
Operating Table---Wiring	34.
Perforator-Wiring	34.
Printer---Wiring	34.
Tape Transmitter---Wiring.	34.
Auto Stop Circuit.	34.
Auto Stop Relay Unit---Wiring.	36.
Test Table	36.
Test Table---Wiring.	36.
Test Distributor---Wiring.	38.
Complete Theoretical Diagram	38.

Starting a Morkrum Multiplex Circuit

Operating Table Switches	39.
Position of Switches on Distributor Table.	39.
Fork Weights	39.
Rheostats	40.
Starting Distributors and Forks.	40.
Balancing Jacks.	40.
Synchronizing	41.
Phasing	44.
Orientation	44.
Final Test	45.

MORKRUM MULTIPLEX PRINTING TELEGRAPH SYSTEM.

INTRODUCTION.

The purpose of this specification is to describe the Morkrum Multiplex System and to provide information concerning its installation, operation and maintenance.

The Morkrum Printing Telegraph System consists of an apparatus for automatically transmitting electrical signals over a wire combined with an apparatus for receiving these and translating them into printed characters.

This system may be arranged to transmit over two, three or four channels in one direction or in both directions simultaneously. These specifications will describe two channel duplex operation that is, simultaneous transmission in two directions over two traffic channels.

The message for transmission is first prepared by punching certain combinations in a paper tape by means of a perforator. This tape is then passed through an automatic transmitter which sends certain impulses to the line through the medium of a rotating transmitting distributor. The signals are received at the opposite end of the line by a relay and passed on to a recording printer by a rotating receiving distributor.

SIGNALLING CODE

The Code used on the Morkrum Multiplex System is known as the

SIGNAL

UPPER CASE	-	?	:	\$	3	!	&	£	8	'	()	.	,	9	0	1	4	'	5	7	;	2	/	6	"	SPACE	CARRIAGE RETURN	LINE FEED	LETTER SHIFT	FIGURE SHIFT	BLANK
LOWER CASE	A	B	C	D	E	F	G	H	I	J	K	L	M	N	O	P	Q	R	S	T	U	V	W	X	Y	Z						
1	○	○	○	○	○	○	○	○	○	○	○	○	○	○	○	○	○	○	○	○	○	○	○	○	○	○	○	○	○			
2	○	○	○	○	○	○	○	○	○	○	○	○	○	○	○	○	○	○	○	○	○	○	○	○	○	○	○	○	○			
3	○	○	○	○	○	○	○	○	○	○	○	○	○	○	○	○	○	○	○	○	○	○	○	○	○	○	○	○	○			
4	○	○	○	○	○	○	○	○	○	○	○	○	○	○	○	○	○	○	○	○	○	○	○	○	○	○	○	○	○			
5	○	○	○	○	○	○	○	○	○	○	○	○	○	○	○	○	○	○	○	○	○	○	○	○	○	○	○	○	○			

FIGURE 1. 5 UNIT CODE

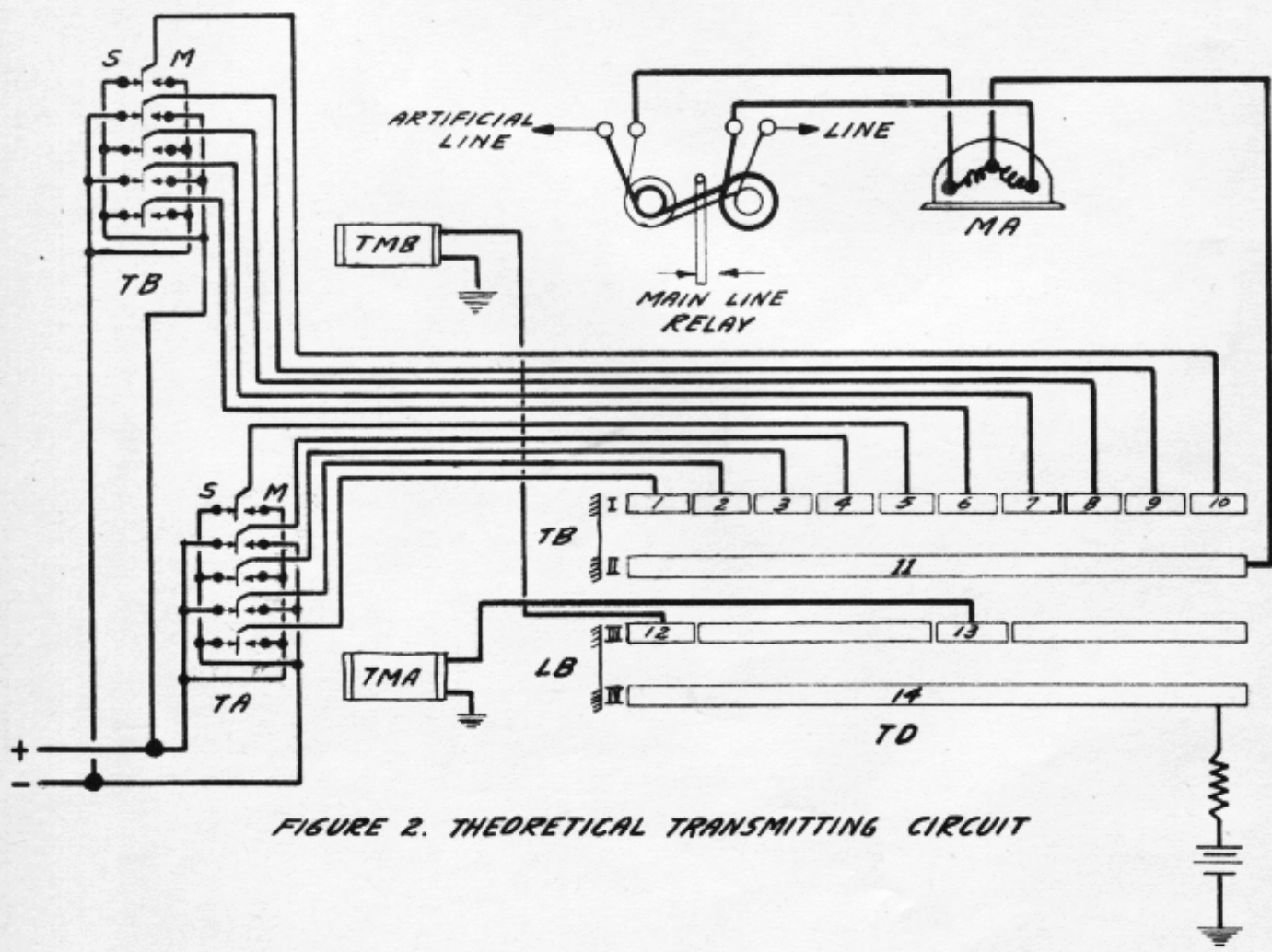

FIGURE 2. THEORETICAL TRANSMITTING CIRCUIT

five unit code. If a given unit of time be divided into five intervals during each of which either positive or negative current may be transmitted, it is possible to produce 32 combinations of five positive and negative intervals.

Figure 1 shows graphically the combinations as they appear on the perforated tape. Each vertical row represents the five intervals of a complete unit of time during each of which the current transmitted may be either positive or negative. The squares with the 0 in them represent the holes in the tape or the marking impulses, that is, the impulses which would operate the corresponding selectors of the printing mechanism; and the blank squares represent the spacing impulses or the ones which would not operate the selectors on the printing mechanism.

TRANSMISSION.

Referring to figure 2, TA and TB theoretically represent the tape transmitters of the A (first) and B (second) channels respectively, TD the developed segments of the transmitting distributor head, and TB and LB their associated brushes. The brushes are revolved by a driving motor shown in figure 5. The upper row of segments numbered 1 to 10 are the transmitting segments to which are connected the tongues of the tape transmitters. The first five segments are connected to the five tongues of the transmitter on the A channel and the second five to the five tongues on the transmitter of the B channel. The segment 11 below the transmitting segments is connected to the split of the ammeter and the main line relay. The transmitting brushes TB passing over the transmitting segments connect them successively to segment 11 thus sending current through the two windings of the

milammeter MA and the line relay; one half going to the artificial line and the other half being transmitted over the main line to the distant end. The relay is differentially wound so that the outgoing signals passing through its two windings do not effect the relay as explained under the duplex circuit.

On the third ring segments 13 and 12 are connected respectively to the transmitter magnets on the A and B channels. The fourth ring, segment 14 is connected to battery. Assuming that a certain letter is being transmitted, the five tongues of the transmitters will be against certain of the contacts depending upon the letter to be transmitted. The brush TB will then successively connect the transmitting segments to segment 11 and transmit the impulses over the line. After brush TB has passed off the fifth segment, the local brush LB will move on to segment 13 connecting it to segment 14, thus putting battery on transmitter magnet TMA. This magnet when operating will step the tape in that transmitter forward so as to bring the perforations over the pins for transmission of the next letter. The impulses from the transmitter on the second channel will then be successively transmitted over the line by brush TB, and at the end of its fifth pulse, brush LB will connect the transmitter magnet TMB on the B channel transmitter to battery through segments 13 and 14, causing the tape in the B channel transmitter to move forward one letter.

DUPLEX CIRCUIT.

In order to obtain simultaneous operation in both directions over one line wire the differential duplex circuit is used on the Morkrum Multiplex. Figure 3 shows theoretically the differential duplex circuit as used on the system.

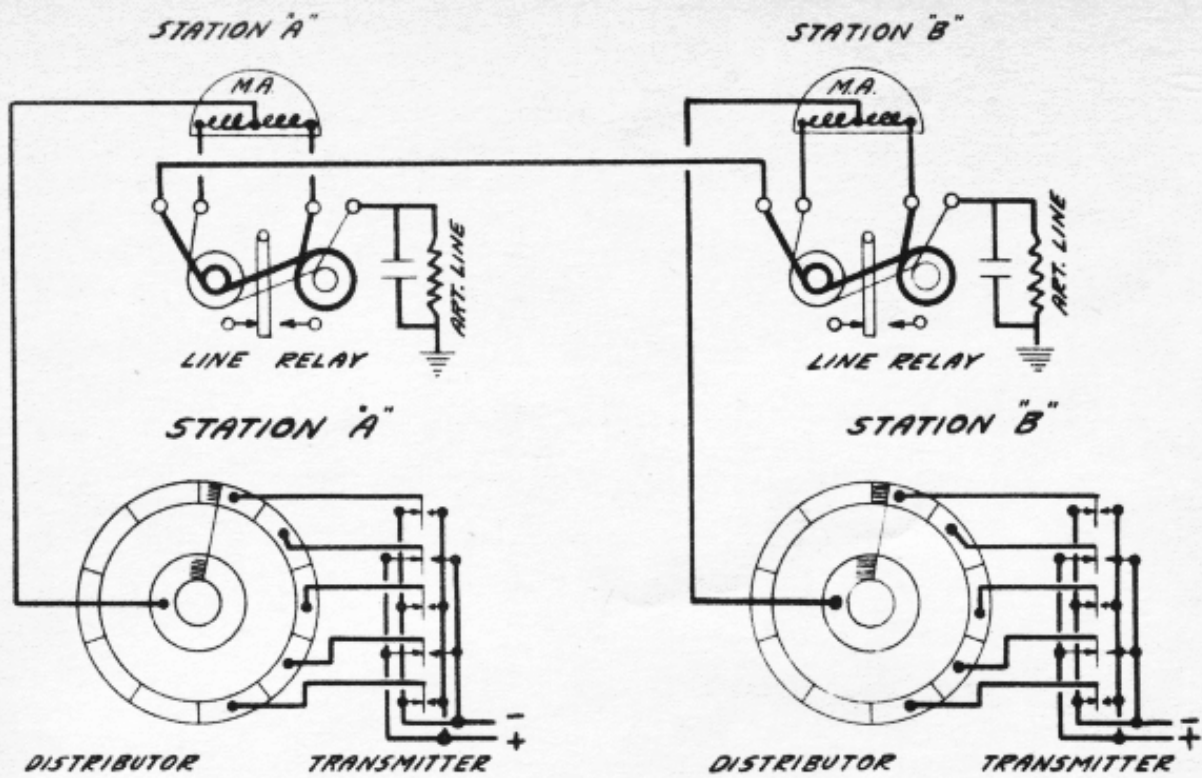

FIGURE 3.
THEORETICAL DUPLEX CIRCUIT

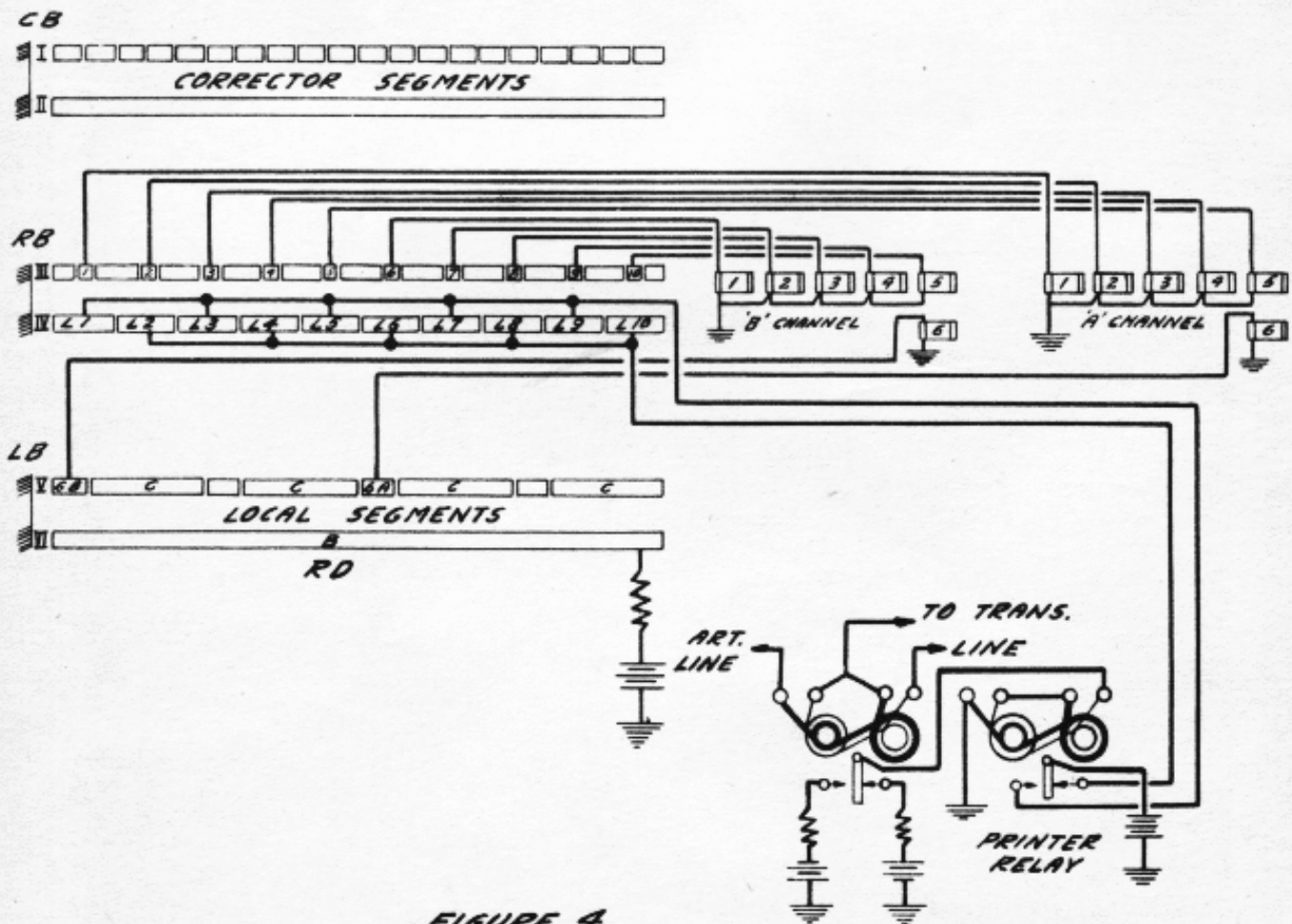

FIGURE 4.
THEORETICAL RECEIVING CIRCUIT

At each end of the circuit is a differential line relay which has two exactly similar windings. A terminal of one winding is connected to the artificial line and a terminal on the other winding is connected to the main line. The two other terminals of the windings are connected to a milammeter as indicated. The center connection of the milammeter is connected to the transmitter or the pole changer key. An outgoing signal originating at station A will go from battery to the middle point of the milammeter one half of the current going through one winding of the milammeter, one winding of the line relay and out over the line; and the other half going through the second winding of the milammeter and relay, through the artificial line to the ground. The resistance and capacity of the artificial line are adjusted so as to balance the resistance and capacity of the main line. The current flowing in each of the windings of the line relay will therefore be equal and opposite so that the relay is not affected by the outgoing signals.

At station B however, the impulses coming over the main line will pass through the line relay at that station and unbalance the circuit causing unequal currents to flow in the two windings of the relay, thus causing the relay at station B to operate. If both stations are sending at the same time both relays will be unbalanced and signals corresponding to those sent out from each station will be received on the relays at the opposite stations. The main line relay in operating actuates the printer relay which transmits the incoming signals to the printer.

RECEPTION.

Referring to figure 4, RD represents the developed segments of the receiving distributor; and CB, RB and LB the correcting brush, receiving brush and local brush respectively. These brushes are revolved by the driving motor which is exactly like the one used on the transmitting distributor. The 20 upper segments and the long segment beneath it are used in conjunction with the correcting mechanism and its functions will be explained later.

The third row is divided into 20 segments, ten of them being short and known as the receiving segments; and ten intervening longer ones used in conjunction with the speed indicating mechanism.

The fourth row is divided into 10 segments the alternate ones being connected together and to the contacts of the printer relay. These segments are used to pass the received signals to the receiving segments and hence to the selecting magnets in the printer. The first five receiving segments are connected to the five selecting magnets in the first channel printer and the last five are connected to the five magnets on the second channel printer.

The fifth row contains the sixth pulse and corrector operating segments which are connected to the longer segment below them by brush LB. This longer segment is connected to battery. When the receiving brush RB passes off the fifth receiving segment, of either channel, brush LB connects the sixth pulse segment of that channel to battery and causes the sixth pulse magnet in the printer to operate.

SPEED CONTROL.

It is evident that the brushes on the receiving dis-

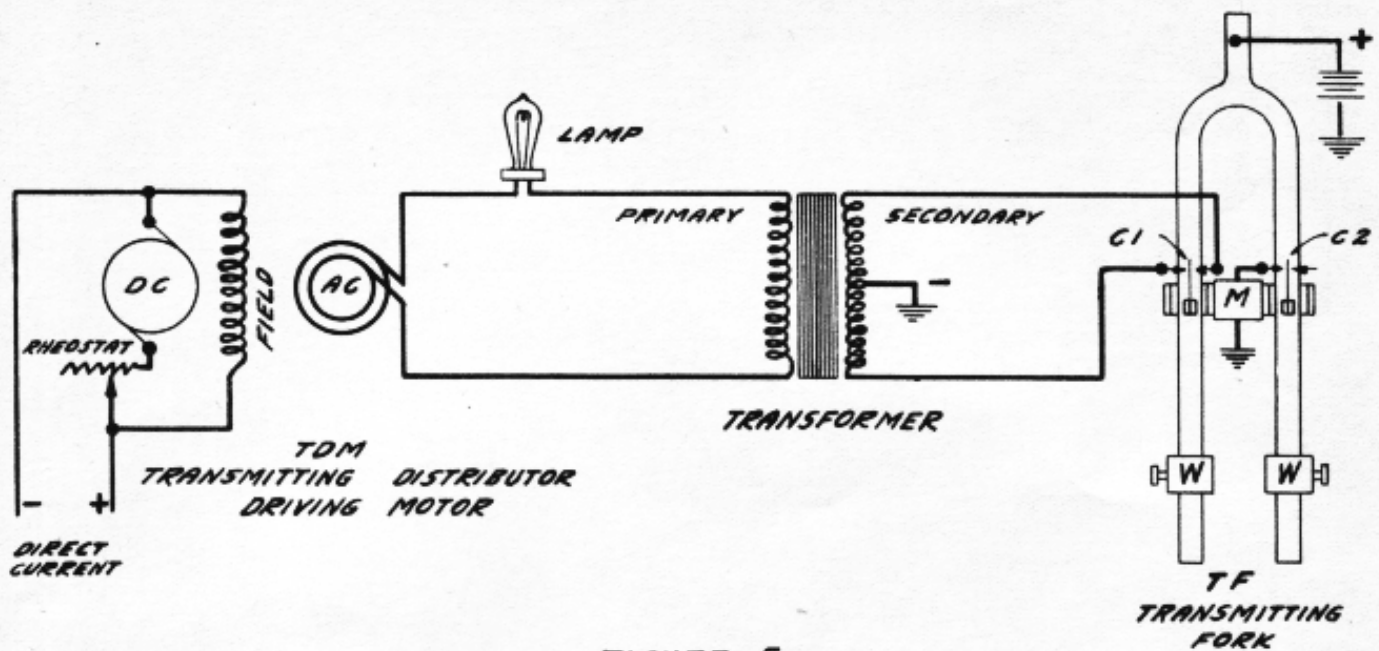

FIGURE 5.
TRANSMITTING DISTRIBUTOR SPEED CONTROL

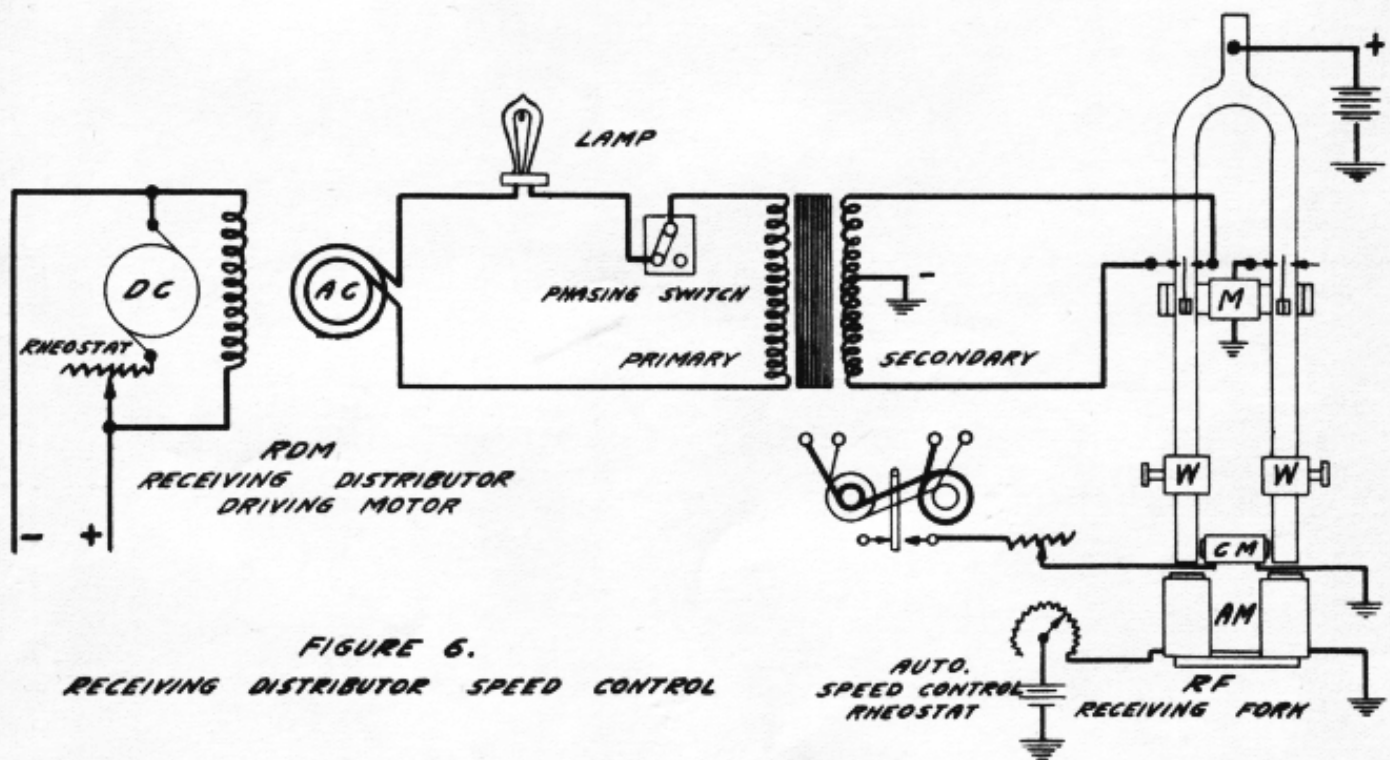

FIGURE 6.
RECEIVING DISTRIBUTOR SPEED CONTROL

tributor must hold a certain phase relation with those on the transmitting distributor and also be running at exactly the same speed in order that the receiving brush be on a segment corresponding to that of the transmitting distributor.

In the Morkrum Multiplex System the transmitting distributor is operated at a fixed speed and the receiving distributor controlled so that its speed and phase relation of its brushes are the same as that of the transmitting distributor.

TRANSMITTING DISTRIBUTOR MOTOR CONTROL.

Figure 5 shows the transmitting distributor motor and its associated apparatus for keeping its speed constant.

TDM represents the motor which is essentially a rotary convertor. DC is the direct current side of the armature which is connected to a direct current source of power through a rheostat. F is the shunt field which is connected directly to the D.C. source of power. AC is the alternating current side of the rotary and is connected to the primary side of a transformer in series with lamp L. The secondary winding of the transformer has a neutral tap which is connected to one side of battery. The ends of the secondary winding are connected to two contacts on the transmitting fork TF. These contacts are alternately connected to battery through the contact spring C1 mounted on the left hand tine of the vibrating fork TF.

The fork is kept in vibration by a magnet M the circuit of which is made and broken by the vibration of the contact spring C2 (On the right hand tine of fork) against the contact to which the magnet is connected. The rate of vibration of the fork is determined by the two weights W which may be adjusted to give the desired speed.

Let us assume that weights W have been set to give the proper speed of vibration of the fork. If the fork is started it will continue to vibrate due to the making and breaking of the circuit through the magnet M . The contact spring $C1$ making with its right and left hand contacts will alternately send current through the two halves of the secondary winding of the transformer T in opposite directions. This reversing of the current in the secondary winding will induce an alternating current in the primary winding of the transformer which is connected to the alternating current brushes of the rotary convertor.

The DC side of the convertor is connected to a direct current source of power in series with the rheostat R . If the rheostat is adjusted so that the direct current will operate the convertor at such a speed that the frequency of the current generated by the AC side is somewhere near the frequency of the alternating current produced by the action of the fork, the alternating current produced by the action of the fork will pull the rotary convertor into synchronism with it and operate the convertor as a synchronous motor. It is evident therefore, that this motor will continue to run at the synchronous speed of the alternating current produced by the fork. It is necessary to bring the rotary up to speed with DC current and to supply DC current to it because the fork cannot supply sufficient AC current to operate the rotary. Due to the fact that the speed of the fork is very constant, the speed of the motor will also remain constant. The lamp L acts as a stabilizing load for the rotary and as an indicator, showing when the frequency of the rotary is the same as that of the fork. If the rotary and the fork are not in phase, the lamp will flicker due to the two out of phase currents, one produced by the rotary and the other by the fork. As soon as the two currents are in phase

the lamp will burn at a constant brilliancy.

RECEIVING DISTRIBUTOR MOTOR CONTROL.

Figure 6 shows the receiving distributor motor and its associated apparatus for keeping its speed constant and its receiving brushes in phase with transmitting brushes of the distant station. The circuit for the receiving distributor motor control is exactly like that shown in figure 5 for the transmitting distributor. RDM represents the receiving distributor driving motor, and RF the receiving fork, which controls the speed of the rotary as explained previously.

The receiving fork differs from the transmitting fork in that it has two pair of coils which control the speed of the receiving fork. One pair of coils is known as the corrector magnets and the other as the adjusting magnets.

CORRECTOR AND ADJUSTING MAGNETS.

The corrector magnets are mounted above and below the tines and the adjusting magnets in front of the tines on the receiving fork. If current is passed through either of these magnets, the magnetic effect upon the fork tines will increase the rate of vibration thus increasing the speed of the rotary. These magnets may therefore be made to control the speed of the receiving fork by opening and closing their circuits or by varying the current in them. The fork will have a certain speed when the magnets are de-energized and a higher speed when they are energized.

SYNCHRONISM - GENERAL.

Synchronism between the transmitting and receiving distributor at

two ends of line is maintained as follows:- The speed of the transmitting distributor is set at a predetermined value by placing the fork weights at the proper position for that speed. The speed of receiving distributor is set so that it is slightly less than that of the distant transmitter when the corrector magnet circuit is open. The corrector magnet circuit is then closed and the current through these magnets adjusted so that the receiving fork will cause the receiving distributor to run slightly faster than the transmitting distributor. An automatic means is provided to open the corrector circuit when the receiver speed is greater than that of the transmitter and to close the corrector circuit when the speed of the receiving distributor is less than that of the transmitter. It is obvious that the speed of the receiving distributor will oscillate between limits slightly above and below that of the transmitting distributor. This speed difference is very small, the position of the receiver brushes never advancing or lagging more than a few degrees from that of the transmitting brushes. The current through the magnets is controlled by the incoming signals as will be explained later.

PRINCIPAL OF SYNCHRONIZING CIRCUIT

Figure 7 shows the principal of the circuit used for maintaining synchronism between the two ends of a Morkrum Multiplex System. The correcting mechanism is switched on and off by the action of the correcting relay CR which is in turn controlled by the switch relay SR. In practice the number one segments are connected together and to the winding of switch relay SR and the number two segments connected together and to a condenser. In figure 7 however, a separate pair of relays are shown connected to each pair of segments in order to more clearly explain the operation of the mechanism. The switch

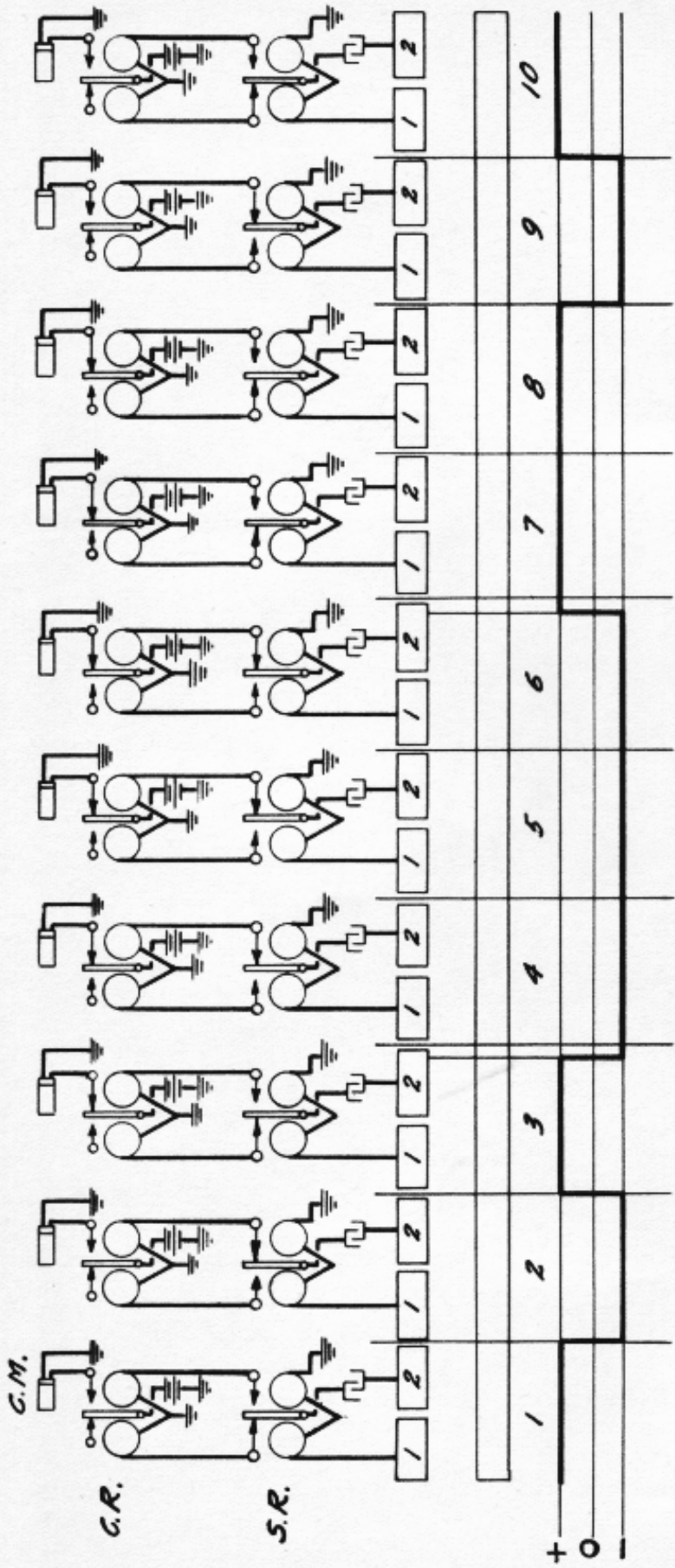

FIGURE 7.
THEORY OF SYNCHRONIZING CIRCUIT

relay is connected so that positive current from the segment will move its armature against its left hand contact and negative current from the segment will move the armature against its right hand contact.

Corrector relay armature will move against its left hand contact when a negative charge is induced on the condenser plate connected to the switch relay tongue, this charge passing thru the left hand winding towards the condenser plate. A positive charge thru the right hand winding of the corrector relay will move its armature in the same direction as above. If a positive charge is induced on the condenser plate thru the left hand winding the corrector relay armature will move against its right hand contact and a negative charge induced thru its right hand winding will also move armature against right hand contact.

The condenser when charged by a current from the number two segments sends a momentary current thru the tongue of one of the contacts of SR and one of the windings of CR. If the condenser has been charged with positive current it will cause a momentary negative impulse to pass thru one of the windings of CR but cannot transmit more current thru CR until it is charged with negative current. In other words if the condenser received the same polarity of current from a number of successive number two segments, only the first charge is effective.

In figure 7 is shown a succession of line impulses covering ten intervals. During the first interval positive current is received. The positive current from segment one in this position will cause the relay SR to move its tongue against the left hand contact. The positive current from segment two will charge one side of condenser positively and induce a negative charge on the plate connected to the tongue of relay SR and this current, flowing through the left hand contact

of relay SR and left hand winding of relay CR, will cause the tongue of CR to move against its left hand contact. In this position the correcting mechanism is not effective.

The second interval is negative, consequently relay SR will move its tongue against the right hand contact and condenser will be charged in the opposite direction so that the plate connected to the tongue of relay SR will receive a positive charge which will flow through the right hand contact of SR and right hand winding of CR and will tend to hold the tongue of relay CR against the left hand contact where it was during the preceding interval.

The third interval is positive so that relay SR will move its tongue again against the left hand contact and current from segment two will reverse the charge on the condenser, putting negative to the tongue of relay SR, which will flow through the left hand winding of relay CR and continue to hold the tongue of CR against the left hand contact. At this point we assume that the distributor brush has dropped back slightly so that at the tail end of segment two, the polarity of the current on this segment is reversed, causing the charge in the condenser to again be reversed and putting a positive charge on the plate of the condenser, connected to the tongue of relay SR and this positive current, flowing through the left hand winding of relay CR, will cause its tongue to move against the right hand contact and render the correcting mechanism effective.

The fourth interval is negative so that relay SR will move its tongue against the right hand contact. As the condenser received a negative charge from the tail end of segment two in the preceding group it cannot again be charged by the same polarity, consequently relay CR is not effected, and its tongue remains against the right

hand contact, continuing to apply correction. The polarity of the line signal remains the same during interval 5, consequently, there is no change in the position in the armatures of either relay.

During interval 6, the polarity of the first segment remains the same so that relay SR is not affected but on the tail end of segment two the polarity is reversed, and the condenser receives the positive charge, inducing a negative charge on the plate connected to the tongue of relay SR and this negative charge flowing through the right hand contact of relay SR and right hand winding of relay CR, acts to hold the tongue of relay CR against the right hand contact where it has been.

During the interval 7 the positive current from segment one causes the tongue of relay SR to move against its left hand contact but positive current from segment two has no effect upon the condenser because it was previously charged with positive current. Therefore, relay CR is unaffected.

The polarity is unchanged during interval 8, so that neither relay is affected but it is to be noted that at the end of interval 8 the brush is again in exact synchronism.

During interval 9 the polarity becomes negative and consequently relay SR moves its tongue against its right hand contact. The condenser receives negative charge from segment two, which induces a positive charge on the plate of the condenser, connected to the tongue of relay-SR, which flows through the right hand contact of SR, and right hand winding of CR, causing the tongue of relay CR to move against its left hand contact and correction is discontinued.

The polarity of the tenth interval is positive and consequently relay SR moves its tongue against the left hand contact and the charge on

condenser is reversed so that negative current flowing through the right hand winding of relay CR, causing its tongue to be held against the left hand contact where it was.

From the above it is seen that when the receiver brush is in exact synchronism with the transmitting brush, segments 1 and 2 will receive the same polarity of current which will not effect relay CR, though if successive intervals are of different polarity relay SR will move its armature in unison with these reversals. When the receiving brush lags slightly behind the transmitting brush so that the tail end of segment two receives the opposite polarity from segment one and the first portion of segment two, relay CR will then have its armature moved to the opposite contact and correction will be applied. This condition will continue until the effect of the correction mechanism has advanced the receiving brush to a position in exact synchronism with the transmitting brush or slightly ahead. When this condition has been produced and a reversal takes place, the relay CR will receive an impulse, causing it to move its armature to the left and cut off the correcting mechanism.

CORRECTION SIGNALS WHEN TAPE TRANSMITTERS ARE IDLE.

It is essential that some means be provided to send out reversals when the tape transmitters are running idle, that is when no tape is being sent through the transmitter. It is obvious that if all the transmitters were sending out positive battery that the main line relay at the distant end would remain against the spacing contact and no correction impulses would be received due to the fact that the polarity on the correcting segments would not change. To provide correction impulses when the transmitters are idle the polarity of each alternate contact on the transmitter is reversed;

that is the first marking pulse on the A channel is positive, the second negative, third positive, fourth negative, and fifth positive. On the B channel the first marking is negative, second positive, third negative, fourth positive and fifth negative. It should be noted that when both transmitters are running idle that alternating current will be sent over the line. The alternations therefore furnish different polarities so that correction may be accomplished when the transmitters are idle.

RECEIVING RECTIFYING CIRCUIT.

In figure 4 the fourth ring is divided into ten segments, the alternate ones being connected together. The segments corresponding to the first, third and fifth pulses of the first channel, and second and fourth pulses on the second channel are connected to left hand contact of the printer relay. The segments corresponding to the remaining pulses are connected to the right hand contacts of the printer relay. As stated above the first, third and fifth pulses on the first channel, and the second and fourth pulses on the second channel are marking when the polarity is positive, and the other pulses are marking when the polarity is negative. A negative pulse will cause the printer relay to move against its right hand contact. A positive pulse will cause the relay to move against its left hand contact. A printer magnet will be operated only when the printer relay tongue is against the contact corresponding to the marking impulse for that magnet. For example if the brush RB is connecting the first receiving segment to the corresponding segment on the fourth ring and the impulse being transmitted is marking the relay tongue will be against the left hand contact and will connect the first selecting magnet to battery. However if the impulse is spacing the printer relay tongue will be against the right hand contact and circuit open when the brush passes over the first segment. The corres-

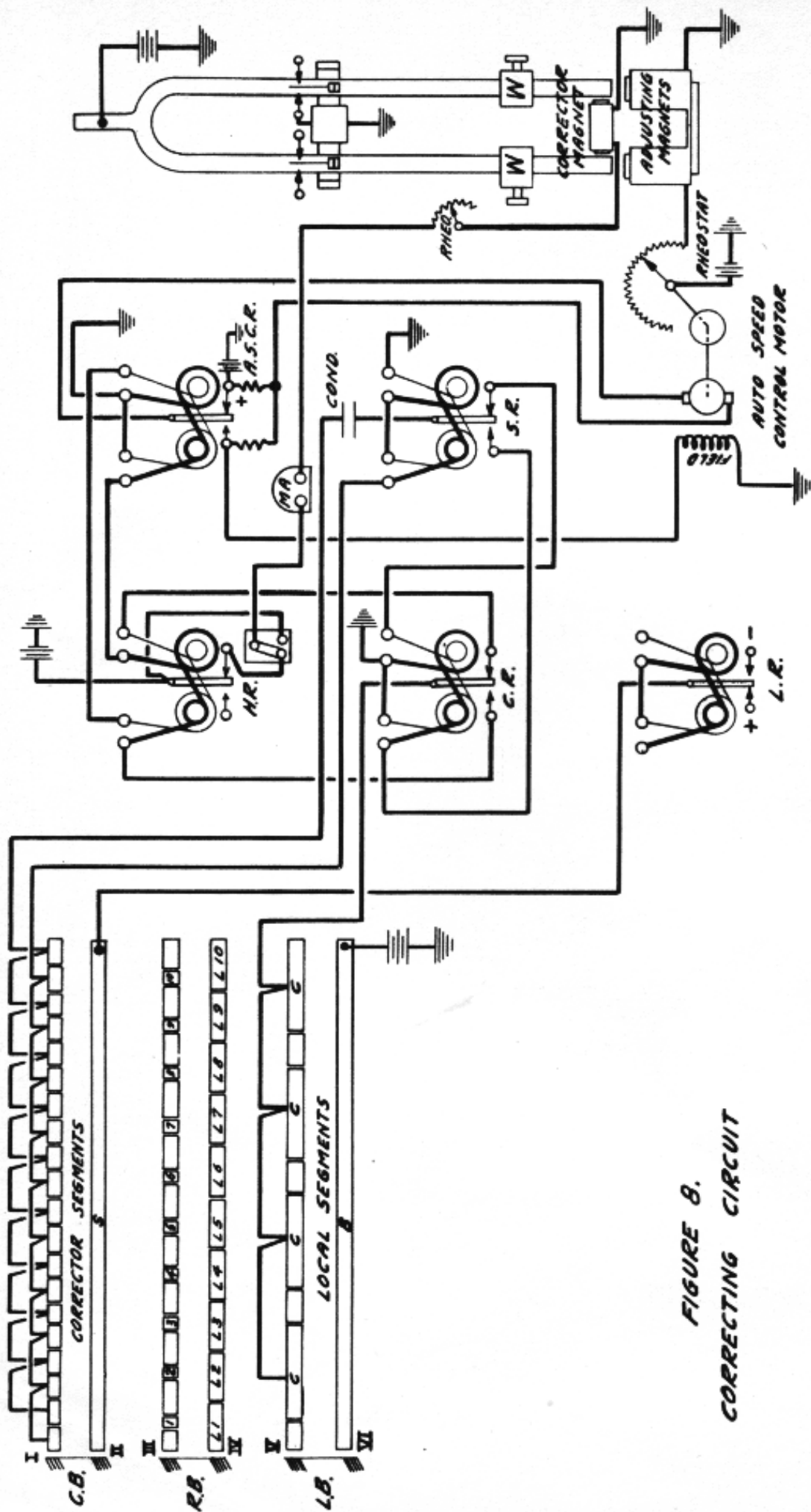

FIGURE 8.
CORRECTING CIRCUIT

ponding selector magnet will therefore not be operated.

COMPLETE CORRECTION CIRCUIT.

Figure 8 shows the complete correcting circuit, and apparatus associated with it.

The correcting segments are shown connected to condenser C and to coils of the switch relay SR as previously explained. In the theoretical discussion of the corrector circuit it was stated that the corrector relay CR when operating connected the corrector magnet to battery. In practice, however, the corrector relay does not connect the magnet directly to battery but operates the corrector magnet through the medium of a secondary holding relay HR. The right and left hand contacts of the corrector relay are connected to terminals on the right and left hand windings respectively, of the holding relay. The tongue of the corrector relay is connected to segments C on the distributor head. The brushes LB in passing over the segments C connect them to segment B which is connected to battery. Let us assume that the corrector relay has its tongue against its right hand contact and that the local brushes LB are passing over the first corrector operating segment C. Current will then flow from battery through the first C segment through the armature and right hand contact of the corrector relay, through the right hand coil of the HR relay and through the right hand coil of the auto speed control relay ASCR to ground. The holding relay will move its armature against its right hand contact and connect the battery to corrector coils.

If the corrector relay has its tongue against the left hand contact the circuit will then be completed through the left hand coil of HR and left hand coil of ASCR to ground, causing the armature of HR to move against its left hand contact and open the corrector coil circuit.

AUTOMATIC SPEED CONTROL UNITS.

We have explained how the current through the corrector coils is controlled by the operation of the corrector, switch and holding relays. Let us now consider the controlling of the adjusting coils on the fork. It should be noted that the coils of the holding relay and auto speed control relay are in series and that the tongues of the two relays follow each other.

The adjusting coils are connected to battery through the rheostat which is controlled by the auto speed control motor. The motor turning in one direction will increase the resistance in the rheostat and turning in the opposite direction will decrease the resistance in the rheostat thus regulating the current through the adjusting coils. A resistance is connected to each contact of the auto speed control relay. The opposite ends of these resistances are joined together and connected to one side of the auto speed control motor. Positive battery is connected to the right hand contact of the relay. One side of the motor field is connected to negative and the other side to the left hand contact of the relay. Let us assume that the armature of the relay is against its right hand contact; we would then have positive battery through the right hand contact and tongue of the relay through the motor armature, left hand resistance, motor field to negative battery as shown in figure 8. The motor will revolve, in this case, so that the rheostat will decrease its resistance and increase the current through the adjusting coils thus increasing the speed of the fork. If the armature of the relay is against its left hand contact we will have negative battery through the motor field, left hand contact and armature of the relay through the armature of the motor (in the opposite direction to that when the tongue was against its right hand contact), through the right hand resistance to

positive battery. The current flowing oppositely through the motor armature and in the same direction as previously through the field will cause it to rotate in the opposite direction, increasing the resistance in the rheostat, thus decreasing the current through the adjusting coils and the speed of the fork. The auto speed control motor is geared to the rheostat so that 3000 revolutions on the motor will rotate the rheostat one revolution. A large number of revolutions of the motor will therefore only cause a slight displacement of the rheostat. Since the auto speed control relay follows the holding relay it should be noted that the current through the auto speed control motor is continually being reversed and that the rheostat will revolve first in one direction and then in the other. The purpose of the adjusting coils is to take care of slight changes in the fork speed which may cause slight speed changes in the receiving rotary. If the correction signals come in regularly the auto speed control motor is reversed regularly, and the rheostat remains practically at a fixed point. If the speed difference between the two stations is so great that correction is on for a considerable time, the auto speed control motor will continue to rotate in a certain direction until the current through the adjusting coils bring the speed of the fork back to such value so as to make the correction come in at regular intervals.

ORIENTATION.

Orientation or the positioning of the signal with respect to the selecting segment so that the mid portion of the line impulse will be received on this segment is determined experimentally on the Morkrum Multiplex by moving the correcting segments with reference to the receiving segments.

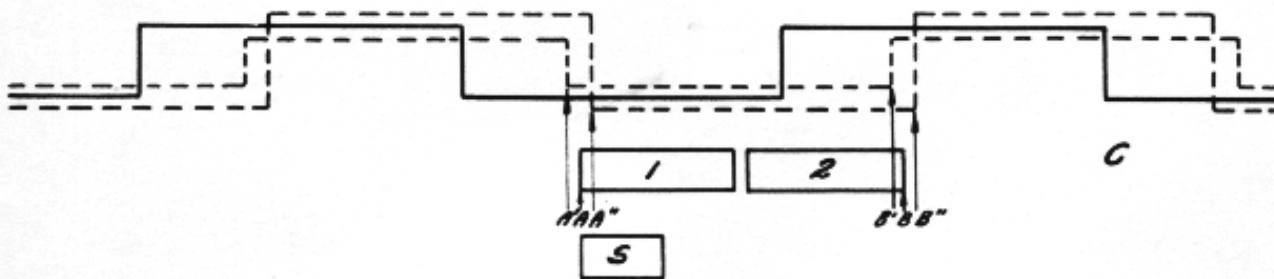
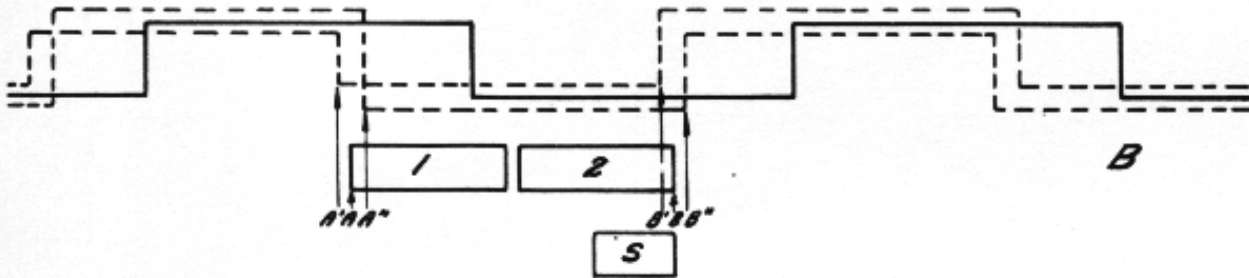
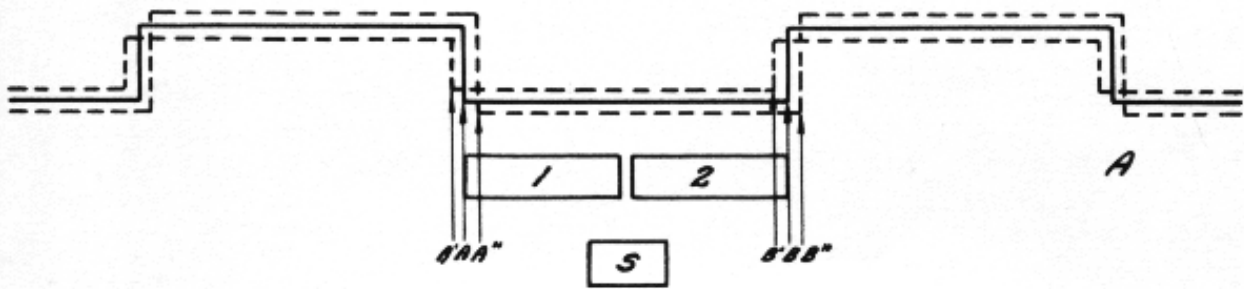

FIGURE 9.
ORIENTATION

From the explanation of the correction circuit given previously it is to be noted that the receiving brushes will oscillate between two limits one slightly ahead and the other slightly behind the transmitting brush position. This is due to the fact that normally with the corrector off, the receiving brush is running slightly slower than the transmitting brush, and when the corrector magnet is on, the receiving brush is running slightly faster than the transmitting brush.

Condition A in figure 9 shows a pair of correcting segments so positioned that the receiving segment is exactly between them. The full line A B represents the received impulses when the receiving brush is in exact synchronism with the transmitting brush. Since the receiving brush is set to run slightly slower than the transmitting brush when the corrector is off, the condition shown by the dotted line A' B' will presently exist. Under this condition the corrector magnet will be energized and the speed of the receiving brush increased until it is slightly greater than the transmitter speed and the line signal will gradually assume the position A" B". When this last condition is reached the corrector magnets will be de-energized, the speed of the receiving distributor reduced, and the line signal will gradually drop back to the position shown by the dotted line A' B'. Thus the line impulses will oscillate, with reference to the selecting segment, between the positions A' and A".

Referring to condition B in figure 9 it is assumed that the correcting segments have been moved backward to the position shown. At the instant the segments are moved back the receiving brush will of course be very much in advance of the segments. This is the

same condition that would exist if the receiver brush had naturally gotten ahead of the two corrector segments in question. It is obvious in this case that the correcting mechanism would disconnect the corrector magnets and permit the brushes to fall back so that the received signal would coincide with the corrector segments 1 and 2. The brushes would then oscillate between positions A' and A'' as in case A mentioned previously. It should be noted that in condition B, however, that the received signal is in such a position that its edge will fall on the received segment S, and that a further displacement of the corrector to the left would move the received signal out of the range of the selecting segment and the pulse would not operate the proper magnet in the printer. This is one limit of the corrector segment position.

Let us assume that the corrector segments have been moved to the right as indicated in condition C of figure 9. In this case the brushes would be advanced until the received signals coincided with the new position of segments 1 and 2, and would then oscillate between the two positions as previously. In this case the received signal would be advanced to its other extreme.

It is obvious that if the corrector segments are first moved to the right until the printer mechanism fails to operate properly, and the corrector segments then moved in the opposite direction until the printer mechanism fails; that a position between these extremes would be the one in which the middle of the received signal would fall on the receiving segment. This is, of course, the best condition for reception.

SYNCHRONIZING LAMPS.

A means is provided for indicating the relative speed of the dis-

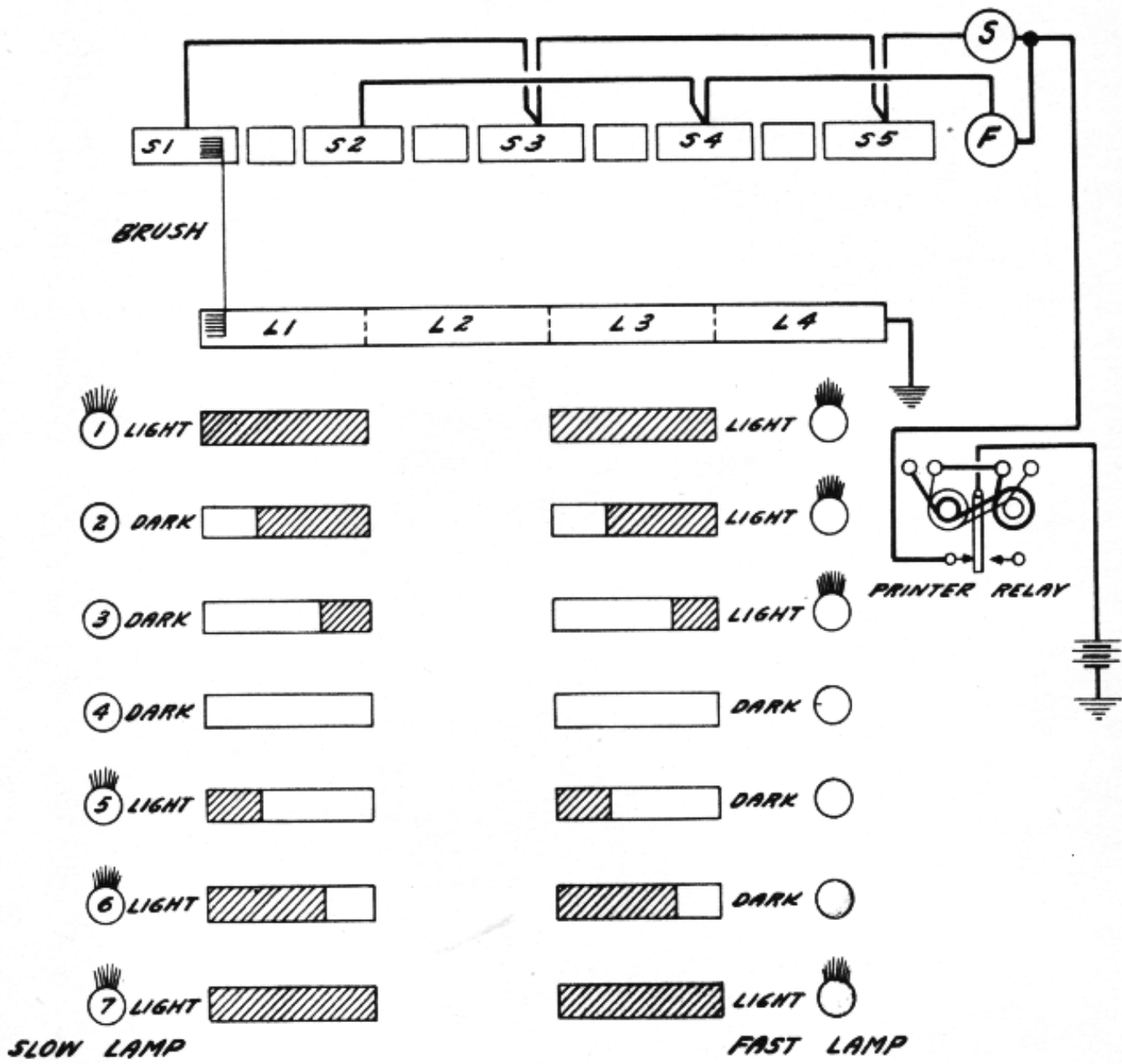

FIGURE 10.

SYNCHRONIZING LAMPS

tributors at the transmitting and receiving stations. The indicating device consists of two lamps so connected that the exact difference of speed between the transmitting and receiving distributors may be determined by the length of time that the lamps are lighted or are dark.

Referring to figure 10, let us assume that we have two rings, one segmented with segments S1, S2, S3, S4 etc., and a solid ring beneath it to which the S segments are connected by the brush. In practice however, instead of using rings this is accomplished by two pair of contacts as will be explained later. The S segments hold the same relation to the receiving segments and are of the same length as those between the receiving segments.

The solid segment is connected to negative battery. The odd S segments are connected together, and to one side of the S or slow lamp, while the even S segments are connected together and to one side of the F or fast lamp. The other side of the two lamps are connected together and to the left hand tongue of the printer relay.

In checking the speed it is first necessary to start up the system and have alternations transmitted from the distant end. Let us assume that the receiving and transmitting distributors are exactly in phase. Let us further assume that the printer relay has its tongue against its left hand contact and that the brush is passing the center of the S1 segment when the pulse is being received. The printer relay having its tongue against the left hand contact will cause battery to flow through the S lamp to the S1 segment and the solid ring to negative battery.

The divisions L1, L2, L3, etc., on the solid ring represents the duration of the transmitted signal. As the brush passes on to the first half of segment S2, the printer relay tongue will still be against its left hand contact and current therefore will flow through the F lamp. Since alternations are being sent from the distant end when the brush reaches the division L2 on the solid ring, the printer relay tongue will be against its right contact, therefore no current will flow through either of the lamps while the brush is passing over section L2. During the next impulse however, the relay tongue will be against its left hand contact and as the brush passes on to section L3, it will send current through the S lamp when it passes over the second half of segment S3, and current through the F lamp as it passes over the first half of segment S4. During the interval of the next signal the relay tongue will again be against its right hand contact so that neither of the lamps will receive current.

It should be noted that when the receiving distributor is in phase with the distant transmitting distributor that current flows through the S lamp while the brush is passing over the odd numbered S segments, and through the F lamp while the brush is passing over the even S segments. The lamps will therefore receive pulses at regular intervals at a frequency high enough to cause them to remain lighted and they will remain lighted as long as the transmitting and receiving brushes are in exact phase. Let us assume another condition, that is, the printer relay tongue being against its right hand contact when the brush is passing over the odd L sections on the solid rings. In this case the two lamps will be disconnected from battery when the brush is passing

over this section and neither lamp will receive current. During the next impulse the relay tongue will be against its left hand contact and battery connected to the two lamps so that when the brush passes over the L2 section of the solid rings current will flow through the two lamps as previously. The two lamps will therefore remain lighted as in the previous condition when the transmitting and receiving brushes are inexact phase.

Let us assume that the receiving distributor is running slightly faster than the transmitting distributor. Referring to the first condition in figure 10, the incoming pulse is shown arriving just as the brush reaches the center of the S1 segment. The shaded portion in the rectangles beneath the L1, L3 and the other odd divisions of the solid ring represent the part of the signal received on those sections while the brush is passing over them. In the first condition the printer relay tongue will be against its left hand contact and current will flow through both the S and F lamps.

Considering the second condition it is assumed that the receiving brushes have advanced with respect to the transmitting brushes and that the signal is arriving just as the receiving brush is leaving the S1 segments. In this case the S lamp would not receive an impulse and the F lamp would. Condition three shows the signals coming in just as the receiving brush is passing on to segment S2. In this case the S lamp would not receive an impulse and the F lamp would. Condition four shows the received signals coming in on the L2 section of the solid ring, but since at this time the printer relay tongue will be against its right hand contact and battery disconnected from the lamps no current will flow through the lamps and they will remain dark.

The fifth condition shows the impulse being received just as the brush is leaving the segment S2. Current will therefore flow through the S lamp only. Condition six shows the pulse being received when the brush just reaches the S3 segment in which case the S lamp will receive current and the F lamp will not. In condition seven the impulse has gained the equivalent of one transmitted impulse, the brush just passing on to section L3 as the impulse is received and both lamps will receive current as in condition 1.

From the above it is evident that if the receiving distributor is running faster than the transmitting distributor that the lamps will be lighted in the following order:- Both lighted, the S lamp out and the F lamp lighted, both out, F lamp out and S lamp lighted, both lighted. It should be noted that in this case the fast lamp always goes out last.

If the receiving distributor is slower than the transmitting distributor the slow lamp will always go out last.

DISTRIBUTOR TABLE.

Diagram number 487 shows the wiring and the relative positions of the various units on the Multiplex Distributing Table. The upper section of the drawing represents the top of the table on which is mounted the distributors, relays and line balancing equipment.

The center section of the diagram shows the shelf which mounts the control forks, lamps, and rheostats associated with the rotaries on the distributors.

The lower section of the drawing shows the wiring and apparatus

contained in the Table panel box.

RELAYS.

Wiring diagram number 377 shows the internal wiring of the polar relays used on the Morkrum Multiplex. The designations on clips 2, 3, 6 and 7 refer to relays when used as line relays.

FUNCTIONS OF SWITCHES AND KEYS ON THE DISTRIBUTOR TABLE.

TRANSMITTER LOCKING KEY.

The cam key located in the rear right hand corner of the table top is for the purpose of locking the transmitters when alternating current is to be sent over the line for balancing purposes. The transmitter coils are connected to the tongues of the cam key, and normally when the cam key is in its rear or operating position the coils are connected to the transmitter contacts on the distributors. When the key is in its forward or locked position the transmitter magnets are connected to battery thru a resistance. In this position of the cam key the transmitters will be permanently locked in and alternations corresponding to the spacing position of the transmitter contacts sent over the line.

LINE BATTERY AND GROUND SWITCH.

The two outer blades on the line battery and ground switch when in the left or normal position connects line battery to the transmitters and when to the right disconnects the line battery. The center blade on this switch is for the purpose of connecting the line either to the transmitter or to ground; the line being connected to the transmitter when the switch is to the left.

CORRECTOR SWITCH.

When the corrector switch is thrown to the left the corrector magnet on the receiving fork is connected so that its circuit is controlled by the holding relay contact. When the corrector switch is in its center position the corrector magnets are disconnected from the holding relay contacts and the corrector circuit therefore open. When the corrector switch is thrown to the extreme right the contacts of the holding relay are short circuited so that battery is permanently on the corrector magnet. The left hand position of the corrector is the normal operating position, the center position is used when setting the receiving distributor for its slow speed value, and the extreme right hand position for setting it at its fast speed value.

R. SWITCH.

Normally, when the R switch is in its left position positive line battery is connected to the A channel operating table through the switch. When the switch is thrown to the right this positive line battery lead is switched to negative so that all the transmitter contacts will be negative. This sets up the letter R in the A channel transmitter which is used as an indicator for phasing as explained under that heading.

SOUNDER SWITCH.

The sounder switch when in its left or normal position connects the printer relay tongue to the receiving distributor, and in its right hand position connects the printer relay tongue to the sounder.

CONDENSER AND LINE SWITCH.

The left hand blade of the condenser and line switch normally connects the artificial line condensers to ground. When this blade is thrown to the right it disconnects the artificial line condensers from ground. The right hand blade normally connects the line to the winding of the line relay, and in its right hand position connects the line to ground.

PHASING SWITCH.

The phasing switch on the shelf is connected in series with the AC side of the receiving rotary. When this switch is in its normal or left hand position this circuit is closed. When thrown to the right the AC side of the rotary is opened and the AC load removed, thus causing the rotary to speed up. This switch is used when phasing in order to quickly bring the receiving and distant transmitting distributor into proper phase relation.

AUTO SPEED MOTOR SWITCH.

The auto speed motor switch is used merely for the purpose of opening the circuit of the auto speed control unit and thus stopping the motor.

OPERATING TABLE POWER SWITCH.

The operating table power switch located behind the artificial line condensers is for the purpose of controlling the power to the various operating tables. When in its number one (1) position the A channel table only is connected to power. The switch should be in this position when the circuit is being lined up. In its number two (2) position the B channel table only is connected to power, and in its number three (3) position all tables are connected to power which is the normal operating position.

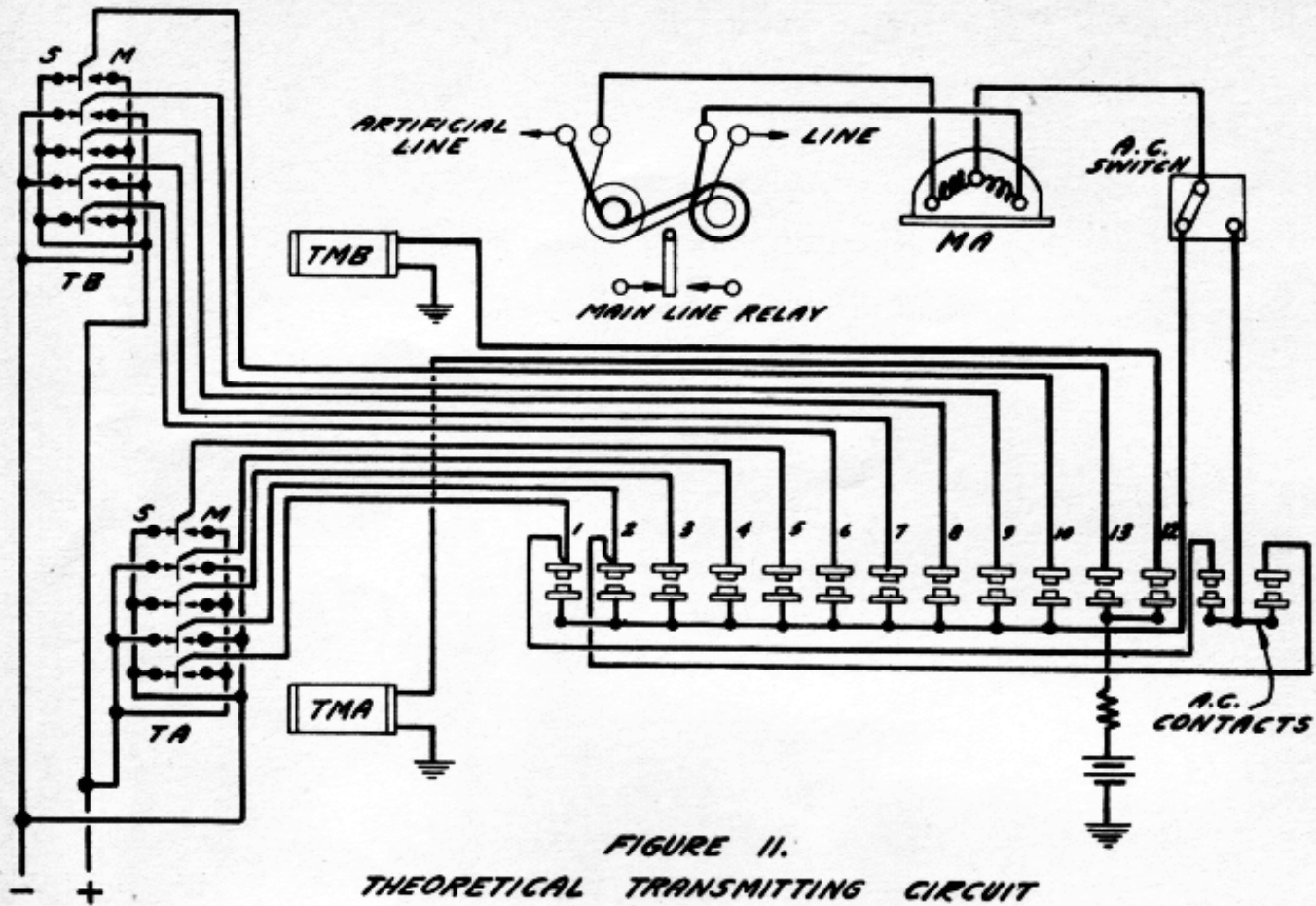

FIGURE 11.
THEORETICAL TRANSMITTING CIRCUIT

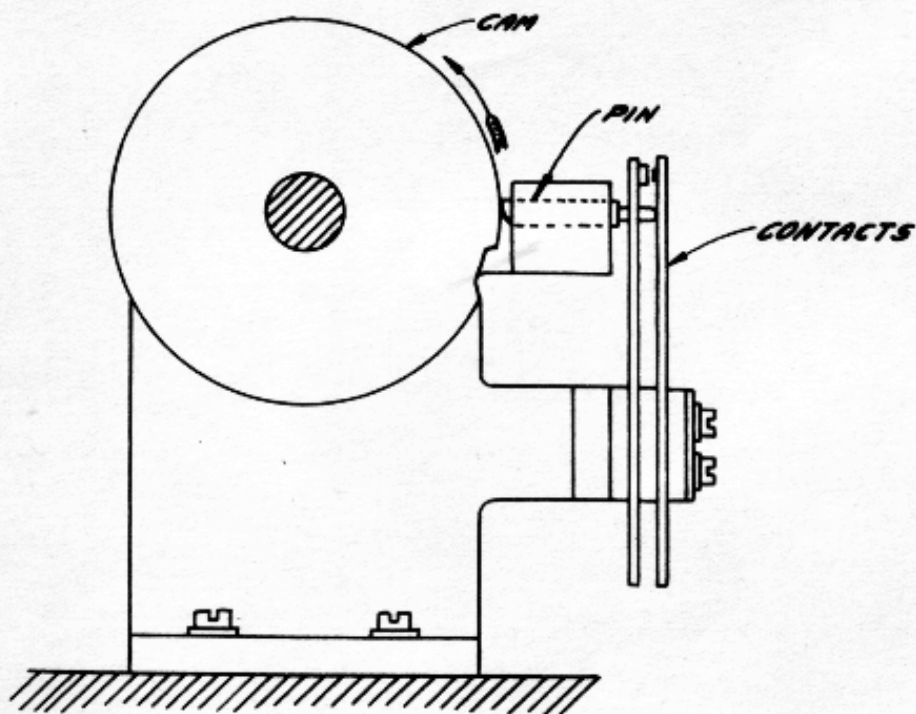

FIGURE 12.
DISTRIBUTOR CONTACT MECHANISM

The off position disconnects all the operating tables from power.

TRANSMITTING DISTRIBUTOR.

In the previous discussion it was assumed that the distributors were equipped with segmented rings, the various connections being made by flexible brushes passing over the segments on two rings.

On the Morkrum Multiplex however, these segmented rings and brushes are replaced by a series of contacts the opening and closing of which is controlled by a series of cams. Referring to figure 11 which shows the contacts on the transmitting distributor, contacts 1 to 10 inclusive correspond to segment 1 to 10 as shown in figure 2. These ten contacts are connected to the ten tongues of the transmitters on the A and B channels in the same manner as the segments were in figure 2.

The inner contacts with which contacts 1 to 10 make are connected together and to the split of the millimeter which corresponds to segment 11 on figure 2.

Contacts 13 and 12 are connected respectively to the transmitter magnets on the A and B channel as were the segments 13 and 12 as indicated in figure 2. The two inner contacts with which contacts 12 and 13 make are connected to battery and correspond to segment 14 in figure 2.

The opening and closing of the contacts is controlled by a series of cams and pins. Associated with each pair of contacts is a small pin, shown in figure 12, which moves in a guide. One end of the pin passes through a hole in the inner spring and presses against the outer spring. If the inner end of the pin rides on the high part of the cam notches the outer contact will be held away from

the inner one. When the pin drops into the cam notches the contacts are closed.

Each pair of contacts is controlled by a separate cam. The notches in the cams are so cut that transmitting contacts 1, 2, 3, 4, and 5 are successively closed, followed by 13 which operates the A channel transmitter magnet. Transmitting contacts 6, 7, 8, 9, and 10 are then successively closed, followed by 12 which operates the B channel transmitter magnet. The length of the notch determines the duration of the pulses.

Diagram number 489 shows the actual wiring of the Morkrum Multiplex Transmitting Distributor. The numbers on the contacts do not correspond to those given in theoretical diagram but refer to the clip numbers on the distributor. Clips 1 to 5 inclusive go to the tongues 1 to 5 respectively on the A channel transmitter 7 to 11 inclusive to tongues 1 to 5 respectively on the B channel transmitter; 6 and 12 to the A and B channel transmitter magnets respectively. Clip 13 is connected to battery for operating the transmitting magnets; and 19 to the split of the millammeter.

Clips 14 and 15 are the Rotor armature DC power terminals, 14 being connected to positive battery through a rheostat and 15 direct to negative battery. Clip 16 is the field lead and goes to positive battery. Clip 17 and 18 are the AC side of the rotary and are connected to the primary side of the transformer.

A. C. CONTACTS.

The two contacts shown at the extreme right of figure 11 are for the purpose of sending out alternating current for line balancing. The outer contacts are connected to the first and second tongues

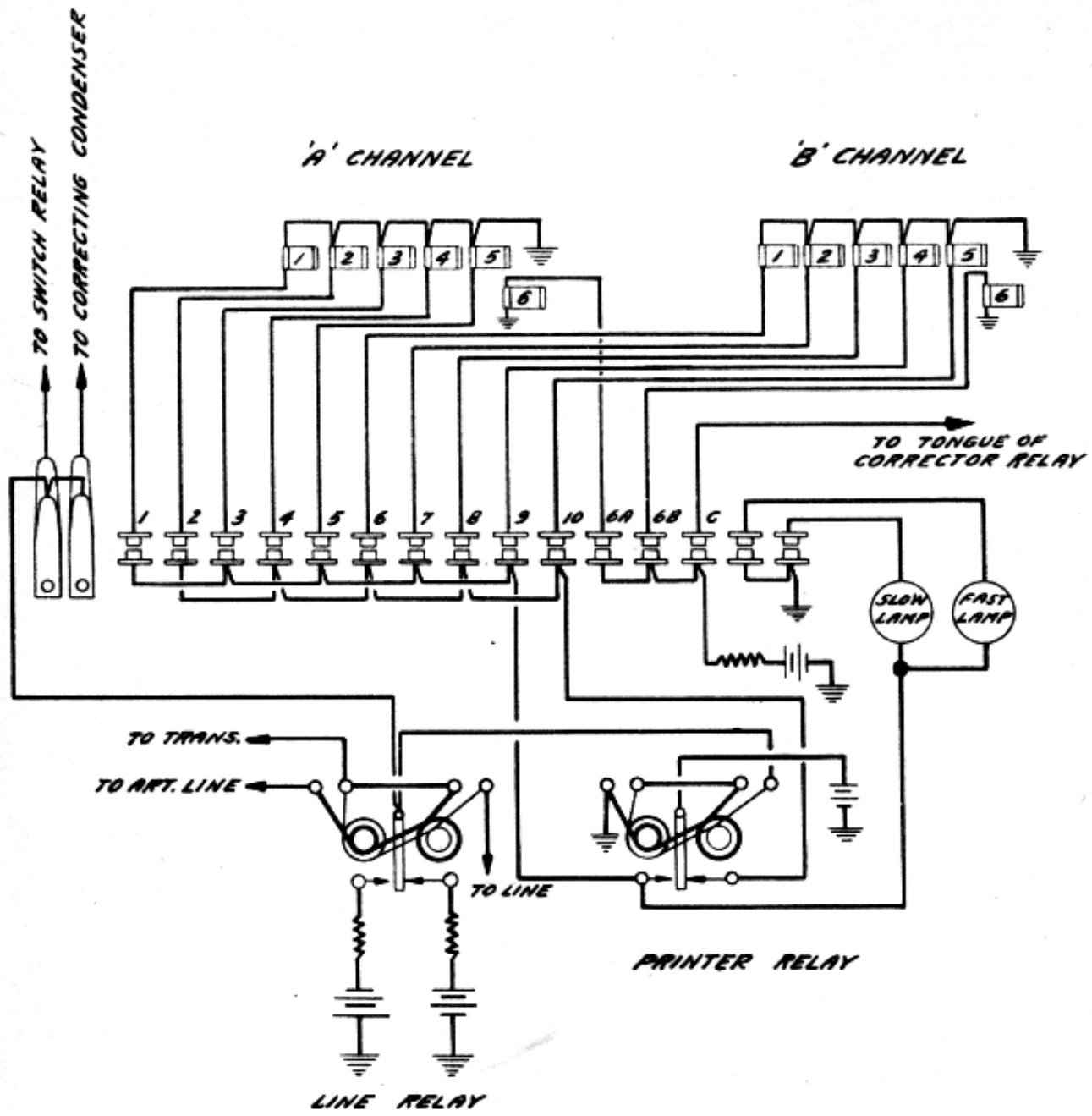

FIGURE 13.

THEORETICAL RECEIVING CIRCUIT

of the A channel transmitter. When AC is being sent over the line the locking key on the distributor table is thrown to its locked position which holds the transmitter in its operated position. Regardless of what combination is set up in the transmitter by the tape, the transmitter being locked will always polarize these contacts oppositely due to the fact that the adjacent contacts in the transmitter are connected to opposite poles of battery. The two inner contacts are connected together and to the terminal on the AC switch on the distributor. When AC is to be sent this switch is thrown to the right connecting the two inner contacts to the split of the milammeter. The two AC contacts are controlled by cams each of which have five notches. These notches are so arranged that they alternately close the contacts thus sending pulses of opposite polarity to the line.

Alternating current could of course be obtained if the transmitters were locked and the regular transmitting contacts permitted to send alternations to the line. Using ten contacts however, introduces a slight variation in the alternations due to contact adjustments, etc.,. A special set of AC contacts is therefore desirable in order to get a perfect balance of the line.

After a line is balanced the AC switch is thrown to the left position connecting the transmitting contacts to the split of the milammeter so that the signals may be sent over the line.

RECEIVING DISTRIBUTOR.

The receiving distributor is equipped with a series of contacts and cams similar to that of the transmitting distributor. Figure 13 shows the theoretical arrangement of the contacts on the re-

ceiving distributor. The outer contacts 1 to 5 inclusively are connected to the five respective selecting magnets on the A channel printer and contacts 6 to 10 inclusive are connected to the five selecting magnets in the B channel printer. Contact 6A is connected to the 6th pulse magnet in the A channel printer and 6B to the 6th pulse magnet in the B channel printer. The inner contacts with which the odd numbered selecting contacts make are connected together and to the spacing contact of the printer relay. The contacts with which the even numbered selecting contacts make are connected together and to the marking contact of the printer relay. It should be noted that the ten selecting magnet contacts and those with which they make correspond to rings III and IV as shown in figure 4.

Contacts 6A, 6B and C are connected to the A channel 6th pulse magnet, B channel 6th pulse magnet, and tongue of the corrector relay respectively. The contact with which these three make are connected together and to battery. These contacts correspond to the rings V and VI as shown in figure 4.

The cams are so arranged that contact 1 to 5 are closed successively followed by contacts 6A, then contacts 6 to 10 are closed successively followed by 6B. The cam which controls contact C has four notches in it so that this contact is closed four times during each revolution. This has the same effect as the four segments C shown in figure 4.

The length of the notches which operate the various contacts is equal to that of the segments as shown in the segmented rings in figure 4.

The two right hand contacts shown in figure 13 are used in connection with the speed indicating lamps and correspond to the two rings shown in figure 10. The one at the extreme right is connected to the slow lamp and the one to the left of it to the fast lamp. The contacts with which these two make are connected together and to negative battery. The notches in the cams which operate these contacts are equal in length to the spaces between the receiving segments and are so arranged that the two contacts will be alternately closed, each contact being closed five times during each revolution.

Comparing the two lamp contacts with figure 10 it should be noted that the two inner contacts are connected to negative battery which corresponds to the solid ring. The extreme right hand contact which is connected to the slow lamp corresponds to the odd S segments and the contact connected to the fast lamp corresponds to the even S segments as shown in figure 10. It is evident therefore that the alternate closing of these contacts will have the same effect on the lamps as explained previously for the brush operation.

The two sets of contacts shown at the extreme left hand of figure 13, are the correcting contacts which correspond to the corrector segments shown in figures 7 and 8. The extreme left hand lower contact corresponds to the right hand segments of each pair and the lower right hand contact to the left hand segment of each pair of corrector segments as shown in figures 7 and 8. The two upper contacts are connected together and

to the tongue of the line relay corresponding to the L segments shown in figure 8. The cams associated with two pair of contacts are notched so that they will alternately close the two pair of contacts thus alternately connecting the two lower contacts with the tongue of the line relay.

The two pair of contacts are so mounted that they may be shifted with respect to the notches in the cams. Moving the contacts with respect to the cams will have the same effect as moving the segmented rings with respect to the receiving segments as explained in the theoretical discussion. These two pair of segments correspond to the rings I and II in figures 4 and 8.

Diagram number 488 shows the actual wiring of the Morkrum Multiplex Receiving Distributor. The numbers on the contacts refer to the clip numbers as explained under the receiving distributor. Clips 1 to 5 inclusive go to the five selecting magnets on the A channel printer, contacts 7 to 11 inclusive to the selecting magnets on the B channel printer, and contacts 6 and 12 to the 6th pulse magnets on the A and B channel printers respectively.

Clips 13 and 24 are connected to the marking and spacing contacts respectively on the printer relay.

Clips 19 and 20 go to positive battery through a resistance, and to the tongue of the corrector relay respectively.

Clips 21, 22 and 23 go respectively to the tongue of the line relay, winding the switch relay, and to the one side of the corrector condenser.

Clips 14 and 15 are the DC power terminals, 14 being connected to positive battery through the rheostat, and 15 direct to negative battery. Clip 16 is the field lead and goes directly to positive battery. Clips 17 and 18 are the AC side of the rotary and are connected to the primary side of the transformer.

TRANSMITTING FORKS.

Diagram number 417 shows the internal wiring of the transmitting forks. The two rear terminals connect to the outer terminals on the secondary winding of the transmitting fork transformer. The third terminal from the rear is connected to negative battery, and the fourth from the rear to positive battery through a resistance.

RECEIVING FORKS.

Diagram number 495 shows the internal wiring of the receiving fork.

The two rear terminals are connected to the outer terminals on the secondary winding of the receiving fork transformer in exactly the same manner as that on the transmitting fork. The third terminal from the rear is connected directly to negative battery, and the fourth from the rear is positive battery through a resistance as in the case of the transmitting fork. The fifth terminal from the rear goes to the auto speed control unit rheostat and the front terminal to the corrector rheostat.

AUTOMATIC SPEED CONTROL UNITS.

Diagram number 472 shows the wiring of the auto speed control unit. Terminal 1 is connected to the two resistance units in the panel box, terminal 2 to the tongue of the auto speed control relay through the auto speed control motor switch, terminal 3, to the left hand contact of the auto speed control relay, terminal 4 to negative battery terminal 5 is blank, terminal 6 is connected to positive battery, and terminal 7 to the corrector magnet on the receiving fork.

OPERATING TABLES.

Wiring Diagram number 470 shows the wiring of the operating tables used on the Morkrum Multiplex. Refer to panel box diagram number 490 for the inter-connections between the operating table and the distributor table.

PERFORATORS.

Diagram number 335 shows the wiring of the Morkrum Multiplex Perforator.

PRINTER.

Diagram number 435 shows the wiring of the Morkrum Typebar Printer used on the Multiplex. The connections of the various clips are obvious from the notes on this wiring diagram.

TAPE TRANSMITTER.

Diagram number 492 shows the wiring of the tape transmitter.

AUTO STOP CIRCUIT.

A means is provided on the operating table for the prevention of the transmission of signals set up by the tape in the transmitter by the lifting of a lever. This is accomplished by means of the auto stop lever, auto stop relay unit, and a pair of special locking coils in the tape transmitter. The auto stop

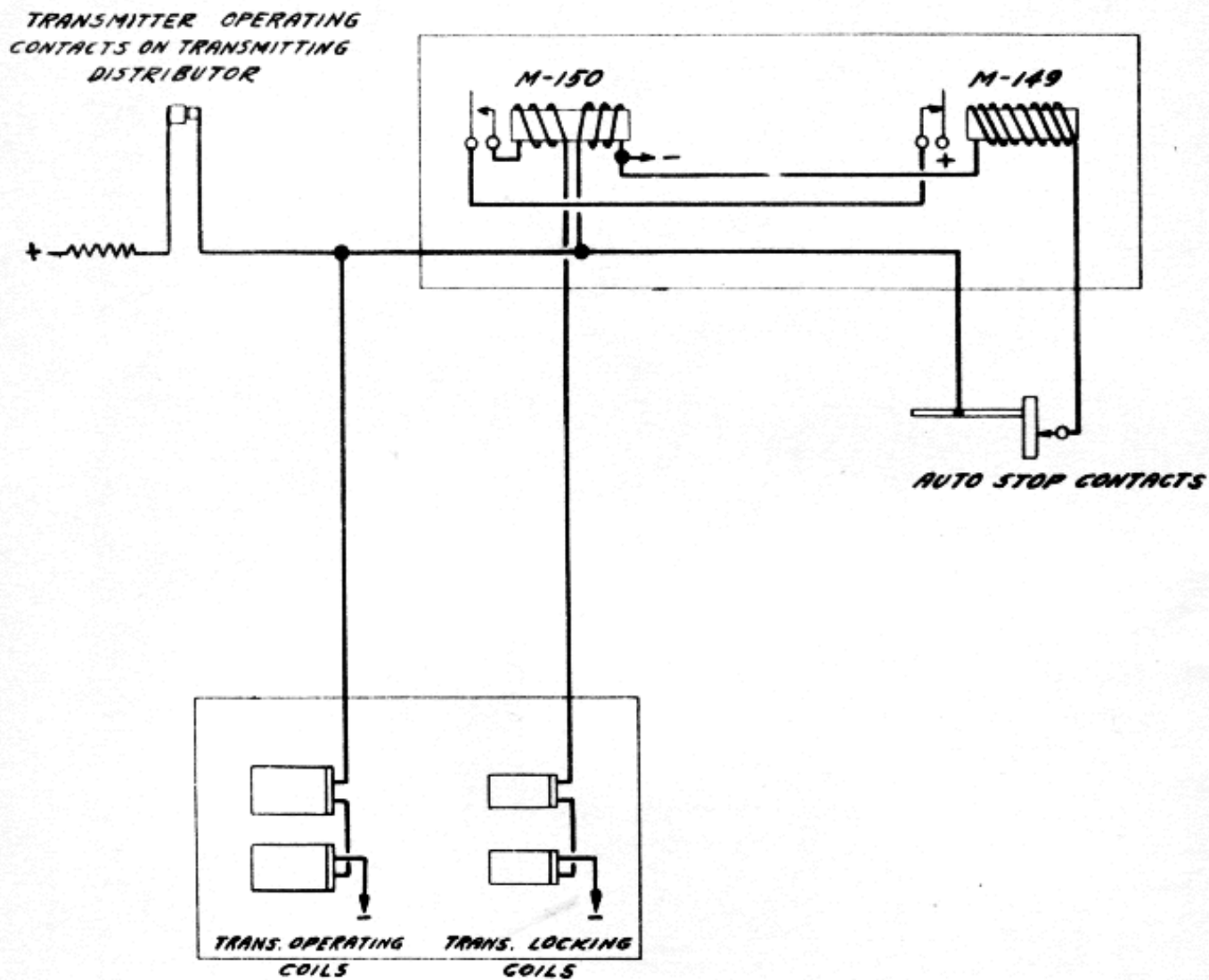

FIGURE 14.
THEORETICAL AUTO STOP CIRCUIT

lever is controlled by the tape passing underneath it between the perforator and the transmitter. Figure 14 theoretically shows this auto stop circuit. Normally the auto stop lever is down and its contacts closed.

The locking coils in the transmitter when operated holds the transmitter armature in its operated position and the tape pins down. In this condition of the transmitter spacing impulses (blank signal) will be sent over the line.

It should be noted that the transmitting locking coils will be operated if relay M150 is operated and M149 is not, since the transmitter locking coils receive battery through the tongue and contact of relay M149; and tongue, contact and winding of relay M150. Each time the transmitter operating contact is closed battery is sent through the transmitter operating coils and also through the right hand winding of M150 relay. If the auto stop lever is down, current will also flow through relay M149. Relays M149 and M150 will therefore be simultaneously operated and the transmitter locking coils will not receive battery.

Let us assume, however, that the auto stop lever has been moved upward, by the tape or manually. In this case when the transmitter operating contacts are closed battery will be sent through the transmitter operating coils and right hand winding of relay M150. The circuit through M149 is, however, open at the auto stop contacts and this relay is therefore not operated. Current will then be sent through the tongue and contact of relay M149; through the tongue, contact and locking winding of relay M150 and through the windings of the transmitter locking coils, thus operating the transmitter locking magnets, and locking the relay M150. The

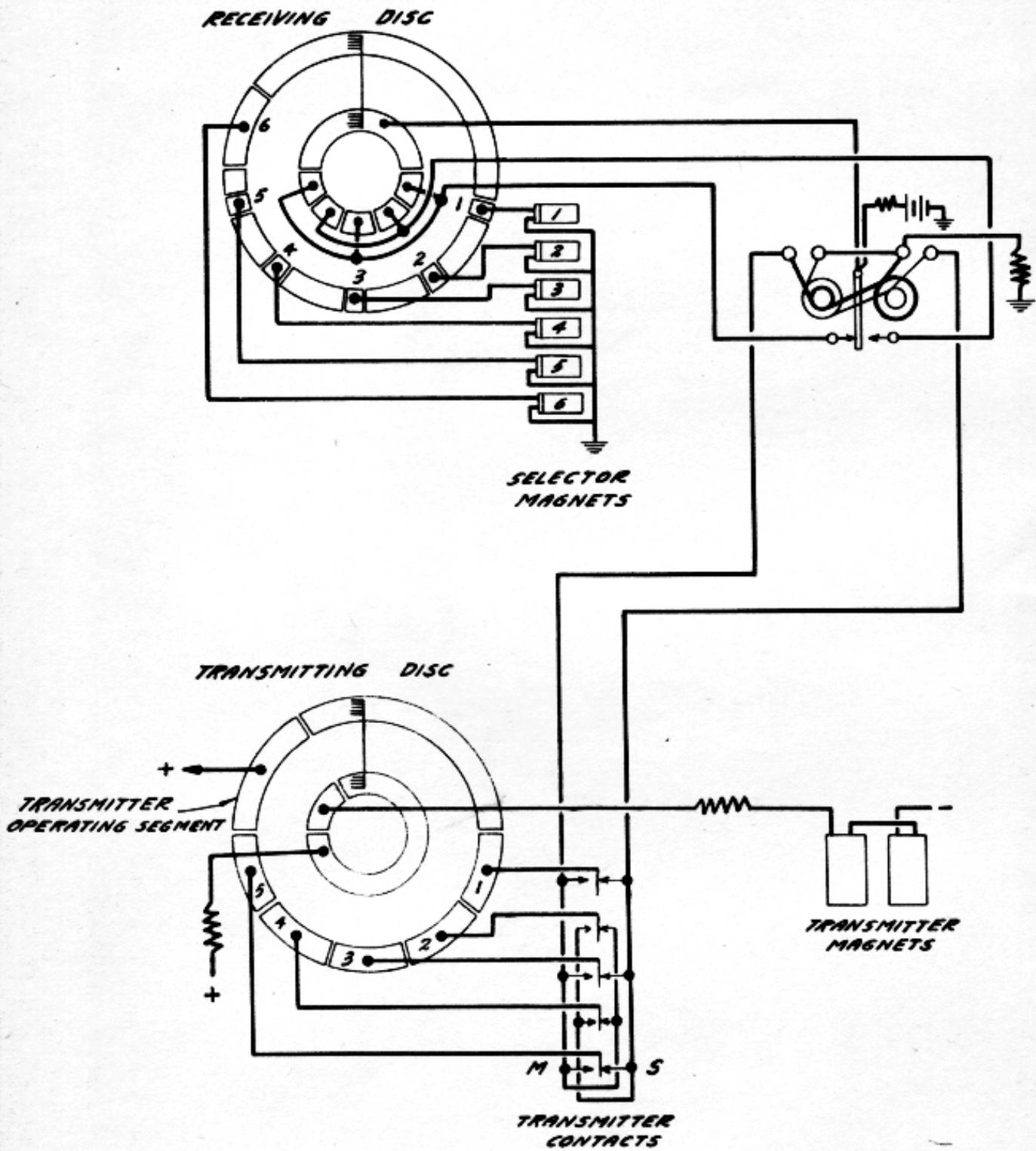

FIGURE 15.

THEORETICAL TEST TABLE CIRCUIT

transmitter locking coils will remain operated until the auto stop contacts are again closed and a pulse is received from the transmitter operating circuit, which will operate relay M149 and disconnect battery from the locking magnets. It should be noted that the relays operate only when the transmitter operating contacts are closed and that it is impossible to operate the transmitter locking coils or the relays during the time that any of the signal units are being transmitted. The transmitter operating coils receive an impulse and are operated every time the transmitter operating contact is closed even when the locking coils are operated.

Wiring diagram number 416 shows the actual wiring of the auto stop relay unit. The first two terminals are connected to negative and positive battery respectively. To the third terminal is connected one side of the transmitter operating coils, transmitter operating contact, and auto stop lever contact. The fourth terminal is connected to the other stop lever contact and the fifth terminal to one side of the transmitter locking coils.

TEST TABLES

Diagram number 469 shows the wiring and the position of apparatus on the Multiplex Test Tables. This table may be used for testing the various units used on the operating tables and also the polar relays.

Figure 15 shows the theoretical circuit of the test tables. The two commutators shown are on the test distributor, the brushes of which are continuously rotated by the motor. The short selecting segments and the sixth pulse segment on the outer ring of

the receiving disc are connected to the five selecting magnets and the 6th pulse magnet of the printer. The first, third and fifth segment on the inner ring corresponding to the five selecting segments are connected to the left hand contact of the relay and the second and fourth to the right hand contact.

The five segments in the outer ring of the transmitter disc are connected to the five tongues of the transmitter. The alternate contacts of the transmitter are connected together, each group going to one of the windings of the polar relay. The inner ring on the transmitter disc is divided into two segments the shorter one being connected to the transmitter magnet and the other direct to battery.

If the first tongue of the transmitter is against its spacing contact battery will flow from the inner ring on the transmitter disc, to the first segment when the brush passes over it, through the tongue and spacing contact of the transmitter, through the winding of the relay to negative battery. This will cause the relay to move against its right hand contact. The receiving brush will at the same time be passing over the first receiving segment but since the relay tongue is against its right hand contact no current will flow through the first selector magnet due to the fact that the inner segment corresponding to the first selecting segment is connected to the left hand contact on the relay. If, however the first pulse is marking the relay will move its tongue against the left hand contact and as the receiving brush passes over the first selecting magnet battery will be connected to this magnet thus operating it. In this way the receiving printer is operated through the distributor. When the receiving brush

passes on to the 6th pulse segment battery is sent through the 6th pulse magnet. On the transmitting disc the transmitting brush passes on to the transmitter operating segment after the transmission of the five pulses and the transmitter magnet is operated.

The auto control circuit on the test table is identical with that of the operating table.

TEST DISTRIBUTOR.

Diagram number 392 shows the wiring of the test distributor used on the test table. Clips 1 to 5 are connected to the five corresponding selecting magnets on the printer, and 6 to the 6th pulse magnet in the printer. Clip 7 is connected to positive battery through a resistance, and 8 and 9 to the spacing and marking contacts of the relay respectively. Clip 12 is connected to positive battery through 1000 ohm resistance. Clips 14 and 15 are connected respectively to positive and negative battery and 16 to the transmitter operating coils. Clips 17 to 21 inclusive are connected to the five tongues on the transmitter.

COMPLETE THEORETICAL DIAGRAM.

Diagram 508 shows theoretically the Morkrum Multiplex System. The various units are not in their true relative positions, but the connections are shown as they actually are on the apparatus.

STARTING A MORKRUM MULTIPLEX CIRCUIT.

It is assumed that all the units on the distributor and operating tables have been tested and are in perfect working order and that all relays are properly adjusted.

OPERATING TABLE SWITCHES.

The Printer switches on all operating tables should be turned on.

POSITION OF SWITCHES ON DISTRIBUTOR TABLE.

The corrector switch should be in its center position, sounder switch to the right, AC switch on transmitting distributor to the right, auto speed control motor switch to the right, transmitter locking switch toward the front. All other switches on the table are in their normal or left positions.

The operating table power control switch on the shelf behind the line condensers is turned to its off position disconnecting power from operating tables.

FORK WEIGHTS

The weights on the transmitting forks are set for the desired speed of the operation in accordance with the following table:-

Approximate words per minute.	Weights	Distance from stop.
33	1 Large, 3 Small.	Against.
37	1 Large, 1 Small.	Against.
41	1 Large.	Against.
45	2 Small.	2"
53	2 Small.	Against.
55	1 Small.	1-3/4"
61	1 Small.	Against.

The weights on the receiving forks should be set approximately $\frac{1}{4}$ " farther out from the stops than those on the transmitting forks.

RHEOSTATS.

The transmitting and receiving distributor motor rheostats are turned clock wise as far as possible, and the auto speed control rheostat is set in its center position. The position of the corrector rheostat is immaterial at this time.

STARTING DISTRIBUTOR AND FORKS.

Depress the transmitting distributor switch thus starting up the transmitting distributor motor. Set the transmitting fork into vibration and turn the transmitting distributor motor rheostat counter clock wise so as to slow up the transmitting motor enough to cause the indicating lamp to burn steadily. This indicates that the rotary is operating at a speed corresponding to that of the fork.

The receiver distributor motor and fork are started in the same manner as the transmitting apparatus.

Due to the fact that the AC switch on the transmitting distributor is towards the right alternating current will now be transmitted over the line from the special AC contacts so that the artificial line at the distant end may be balanced and all repeaters lined up.

BALANCEING JACK.

The jack on the top of the distributor table is used in connection with line balancing indicating device. The jack is normally open circuited and connected across the line relay coils. If a telephone receiver is series with 130 ohms resistance and 0.1 MF condenser (Postal #74 Spark condenser) be plugged into this jack a perfect line balance will be indicated by the elimination of AC reversal sounds in the receiver.

An undulator may be substituted for the receiver. A straight line on the undulator tape indicates a perfect line balance. The above devices provide a more sensitive balance indicator than the line ammeters.

SYNCHRONIZING.

After the line has been balanced the repeaters lined the AC switch on the transmitting distributor should be moved to the left. AC will then be transmitted from the transmitter contacts thus giving actual operating signals. The two ends of the circuit are now ready to be synchronized. As explained previously the receiving apparatus is so adjusted that the receiving distributor motor will run slightly slower than the transmitting distributor motor when the corrector magnet circuit is open, and slightly faster than the transmitting distributor motor when the corrector circuit is permanently closed. The speed difference between the two distributors is ascertained by the two synchronizing lamps on the receiving distributor. The rear lamp is the slow indicating lamp, and the front one the fast lamp. With the switches thrown as explained above the corrector magnet circuit will be open and the receiving distributor should be running slower than the transmitting distributor. For the proper slow speed difference between the two distributors it should take 75 seconds for the rear or slow synchronizing lamp to go from light to light or from dark to dark, the slow lamp going out after the fast lamp or front one. If the front lamp goes out after the rear or slow one the receiving distributor is going altogether too fast and it will

be necessary to slow it down by moving the receiving fork weights towards the front of the fork. After the speed of the distributor is of such value as to make the rear lamp go out before the front one, the 75 second interval should be checked. If the interval of time is greater than 75 seconds the receiving distributor is too fast with respect to the transmitting distributor. The weights on the receiving forks should be moved slightly towards the front of the fork so as to decrease its speed. After moving the weights the slow lamp should again be timed and the weights re-adjusted if necessary. If the interval of time is less than 75 seconds the receiving distributor is too slow with respect to the transmitting distributor, and the weights on the fork should be moved towards the rear in order to increase its speed.

If the receiving distributor speed is not very greatly different from the transmitting distributor speed the 75 second interval can be obtained by adjusting the auto speed control rheostat making it unnecessary to move the fork weights. If the interval is greater than 75 seconds move the rheostat in a clockwise direction, if less than 75 seconds move it in a counter clockwise direction. The final setting of this rheostat should not leave the pointer very far from the vertical position or the auto speed control will not function properly.

After the 75 second interval has been established the corrector switch should be thrown to the right. This will permanently close the corrector circuit and in this condition the receiving distributor should be running slightly faster than the transmitting distributor. It should take 30 seconds for the front or fast synchronizing lamp to go from light to light or from dark to dark,

the fast lamp going out after the slow one. If the fast lamp does not go out after the slow one the 75 second interval as explained above should be re-checked. The constants of the corrector circuit are such that the receiving distributor will always run slightly faster than the transmitting one when the corrector switch is thrown to the right and the 75 second slow interval is correct. If it is found that the fast interval is greater than 30 seconds the speeding up the effect of the corrector magnet is not great enough and the corrector magnet rheostat should be turned in a clockwise direction so as to increase the current through the corrector coils, and therefore increase the speed of the fork. If the interval is less than 30 seconds the effect of the corrector magnets is too great and the corrector rheostat should be turned in a counter clockwise direction so as to decrease the current through the corrector coils, thus decreasing the speed of the receiving distributor.

If the corrector rheostat is turned to its extreme counter clockwise position and the interval remains less than 30 seconds the corrector magnet pole pieces should be moved farther away from the fork tines. This will make the corrector magnets less effective. Care should be taken to keep the pole pieces parallel to the tines.

After the speed of the two distributors has been determined the corrector switch is moved to its normal or left position. In this position of the switch the corrector magnet is placed under the control of the holding relay and the incoming signals.

PHASING.

After the two distributors are operating at the proper speed it is necessary to bring them into proper phase relation with each other, that is, bring the transmitting and receiving brushes on segments corresponding to respective pulses.

Set the range finder so that the indicator is on 13, turn the operating table power control switch to position 1 so that the A channel table is connected to power and ask the distant end to send the letter R. They will then throw their R switch to right and letter R will be transmitted from the distant end on the A channel. The two stations are in phase when the letter R is being received correctly on the A channel printer. If the receiving brushes are ahead of the transmitting brushes the following sequence of letter or functions will be noted on the printer:- J, Carriage Return, K, Blank, Letters, Letters, Blank, V, Line Feed, J and R. If the receiving brushes are behind those of the transmitting brushes the letters and functions will appear in the reverse order. If the letter R is not being printed the phasing switch should be thrown momentarily to the right which will make the receiving brush advance. This should be repeated until the letter R appears on the A printer when the switch should remain in the left position.

ORIENTATION.

The two stations are now in synchronism and in phase. It is yet required to refine the phase relation between the two ends of the line, that is, to bring the receiving brush in such a position so that it is on the receiving segment when the best part of the transmitted signal is received. The distant is asked to send RY-

They will throw their transmitter locking key toward the rear or operating position and run an RY tape through the transmitter on the first channel only. The range finder on the receiving distributor is moved to the right until the printer fails to print RY. The position of the indicator is noted and the range finder moved to the left until the printer does not print RY correctly and the position of the indicator again noted. The indicator is then set midway between the two extremes found.

FINAL TEST.

After range finder has been set in its best position, the operating table power control switch is turned to position 3, connecting all operating tables to power, all other switches on the table are moved to the left, and the distant end asked for test. They will then send a test tape through the transmitters on all channels. When both ends are receiving test copy correctly on all channels the circuit is ready for business. Do not send RY on both channels simultaneously.

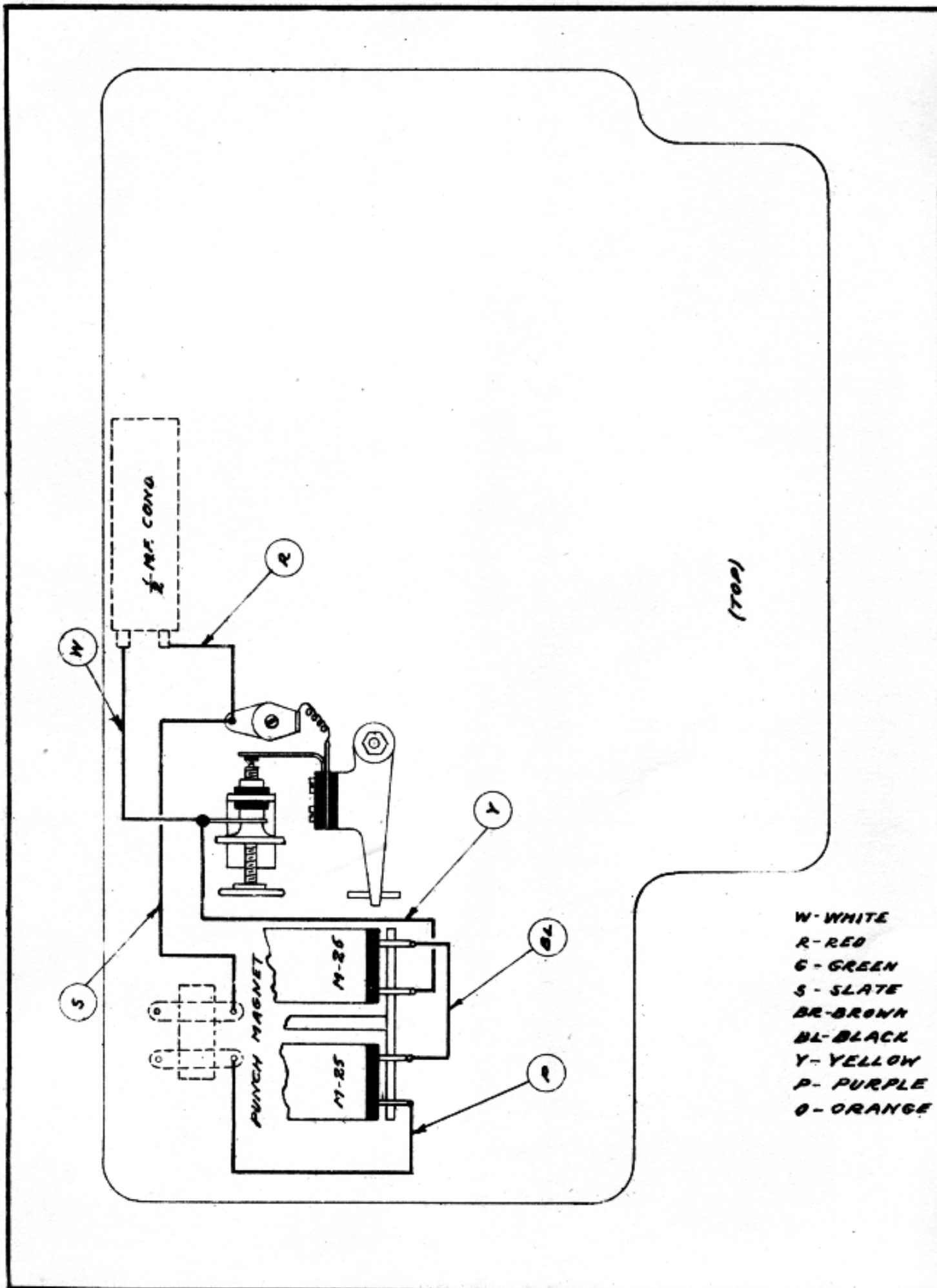

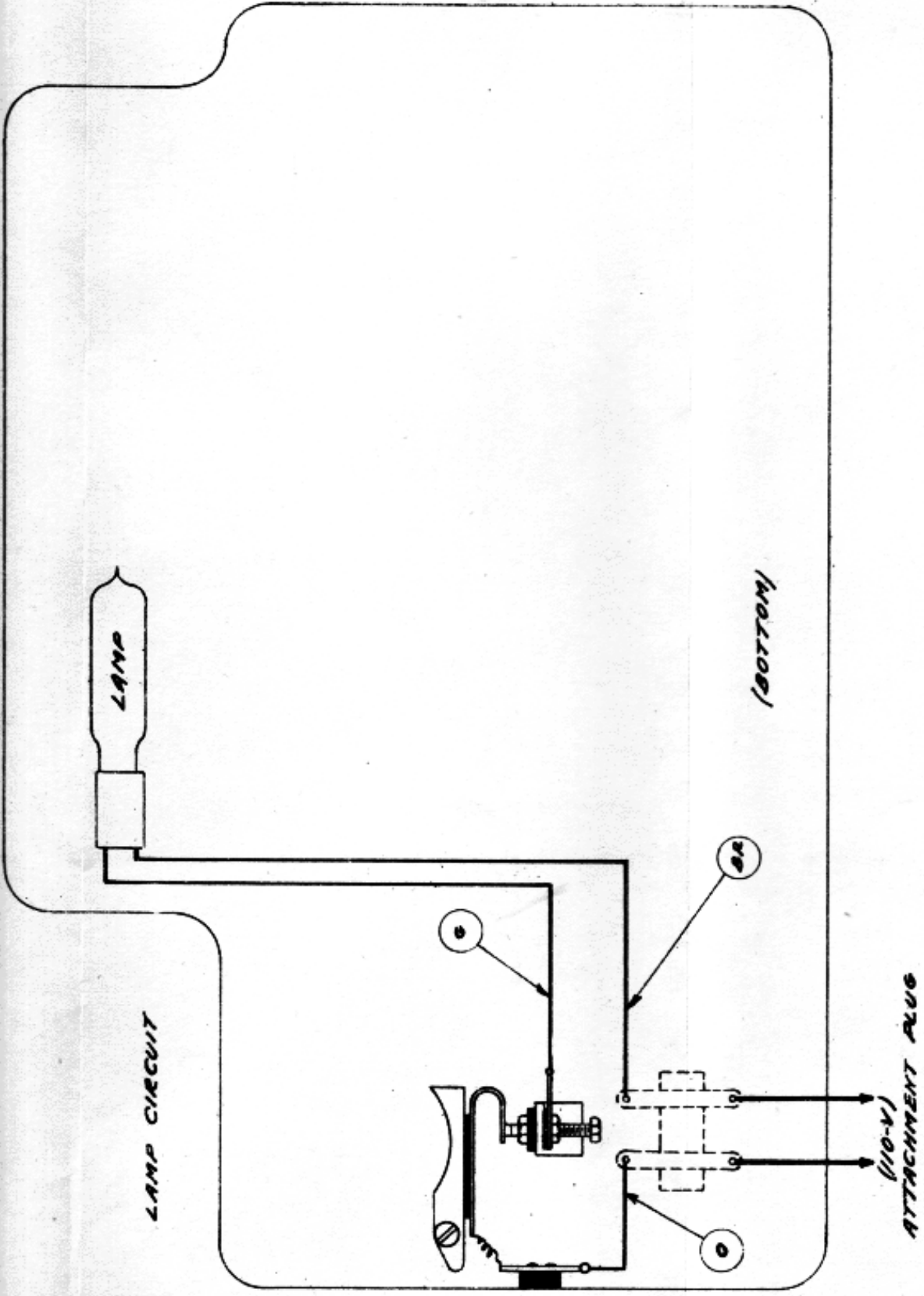

MORSE CO.

335.
APRIL 29, 1919.

WIRING
DIAGRAM
FOR
GREEN
CODE
PERFORATOR

DRAWN BY K.C.C.
TRACED BY L.E.A.
ENGRD. BY K.C.C.
CHECKED BY H.C.C.
APPROVED J.D.G.

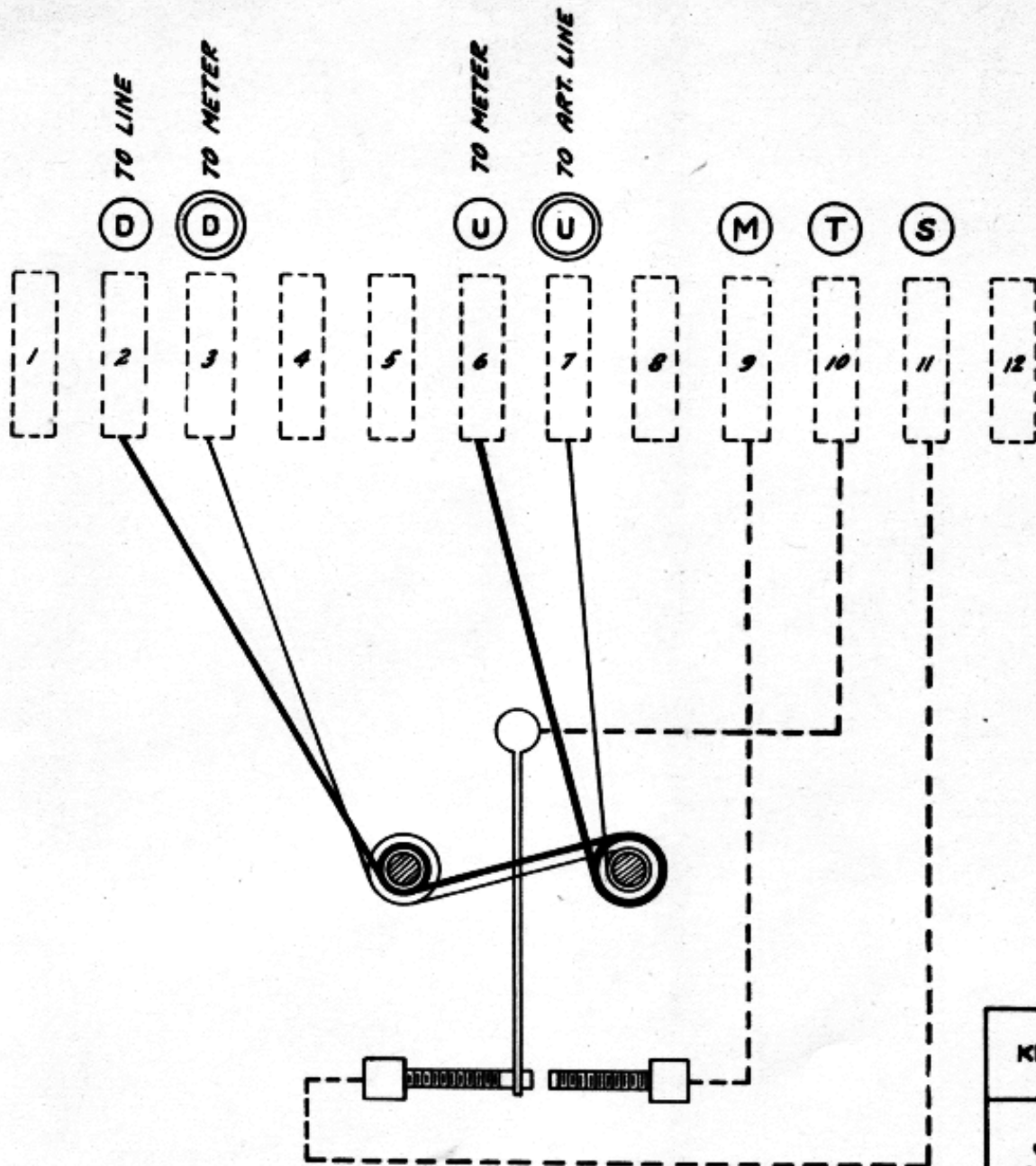

MOKRUM
 KLEINSCHMIDT
 CORPORATION

377
 MAY 7, 1920.

 WIRING DIAGRAM
 FOR COMBINATION
 WHEATSTONE RELAY
 (1-B)
 706
 710
 RY5

 DRAWN *A.S.B.*
 TRACED *E.F.R.*
 CHECKED
 ENG'R'D
 APPROVED *A.S.B.*

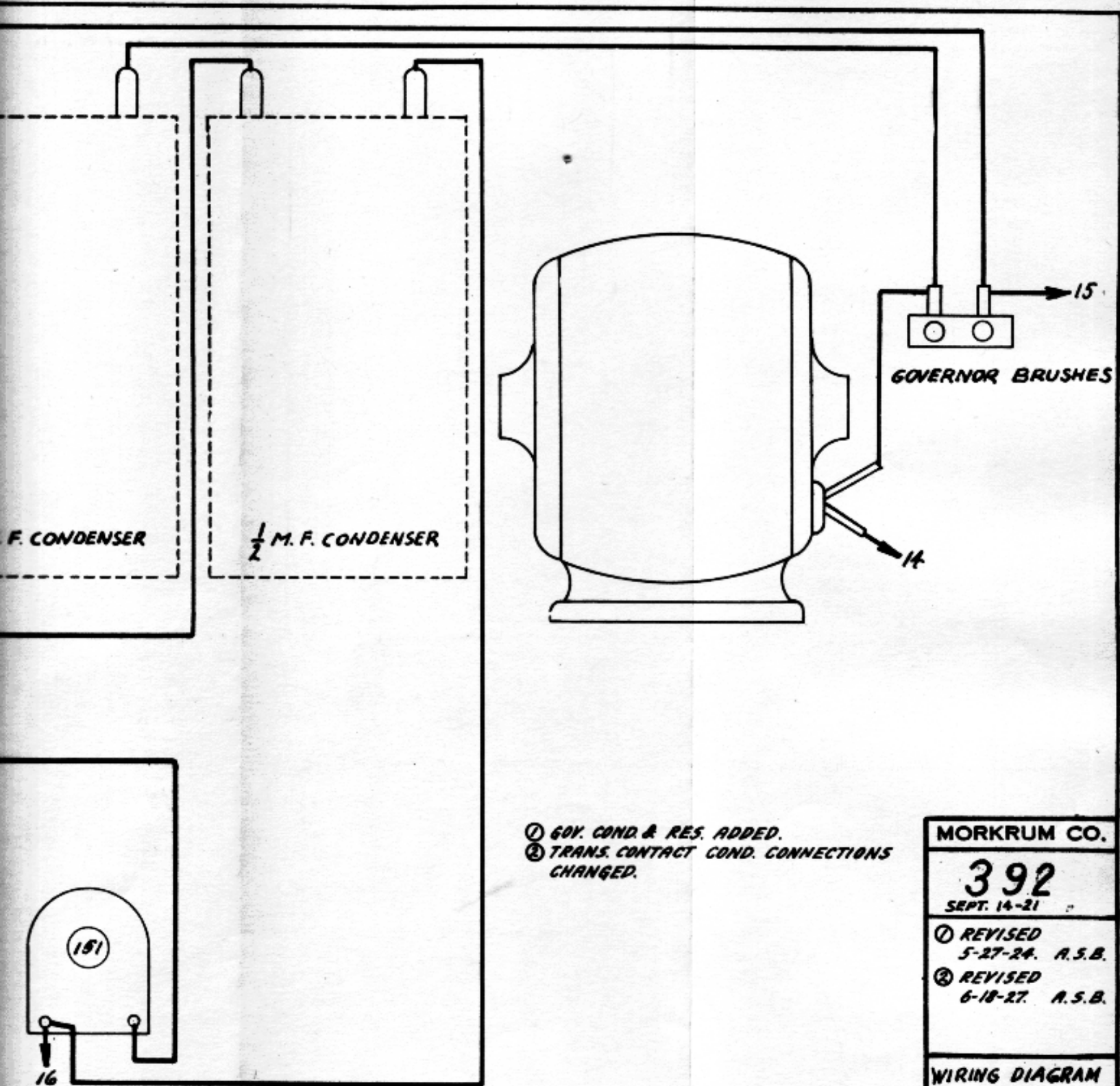

- ① 60K. COND. & RES. ADDED.
- ② TRANS. CONTACT COND. CONNECTIONS CHANGED.

MORKRUM CO.

392

SEPT. 14-21

- ① REVISED
5-27-24. A.S.B.
- ② REVISED
6-18-27. A.S.B.

WIRING DIAGRAM
FOR DISTRIBUTOR
MTD1

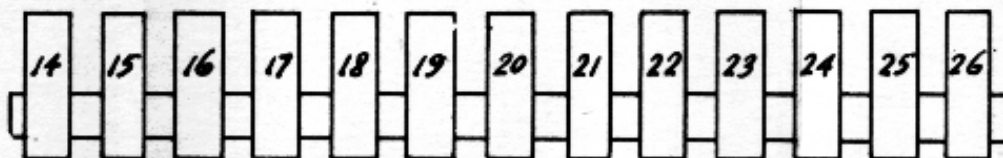

DRAWN A.S.B.
TRACED E.B.
CHECKED
ENG'R D.A.S.B. *asb*
APPROVED

W - WHITE
 G - GREEN
 R - RED
 O - ORANGE
 Y - YELLOW
 BL - BLACK

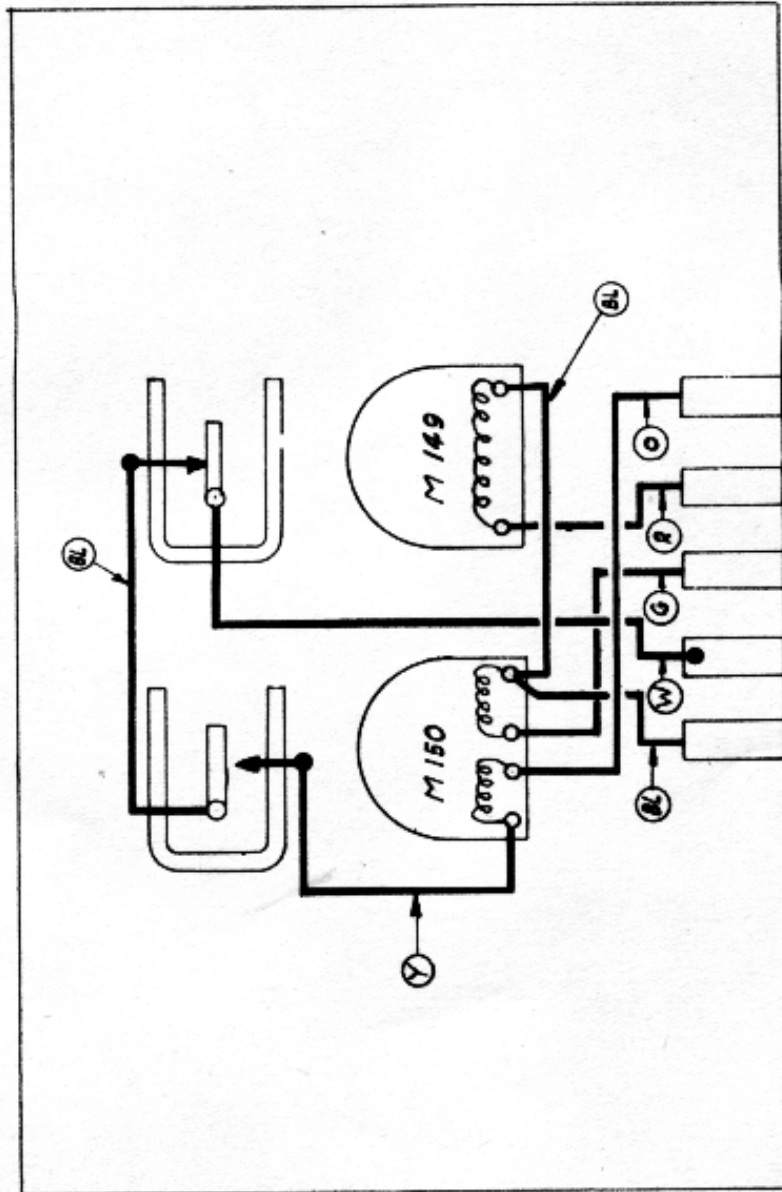

MORKRUM CO.

416

DEC. 20 - 21

WIRING
 DIAGRAM FOR
 RELAY UNIT
 AS1

DRAWN *asb*
 TRACED *HBW*
 CHECKED *asb*
 ENG'R'D *asb*
 APPROVED *asb*

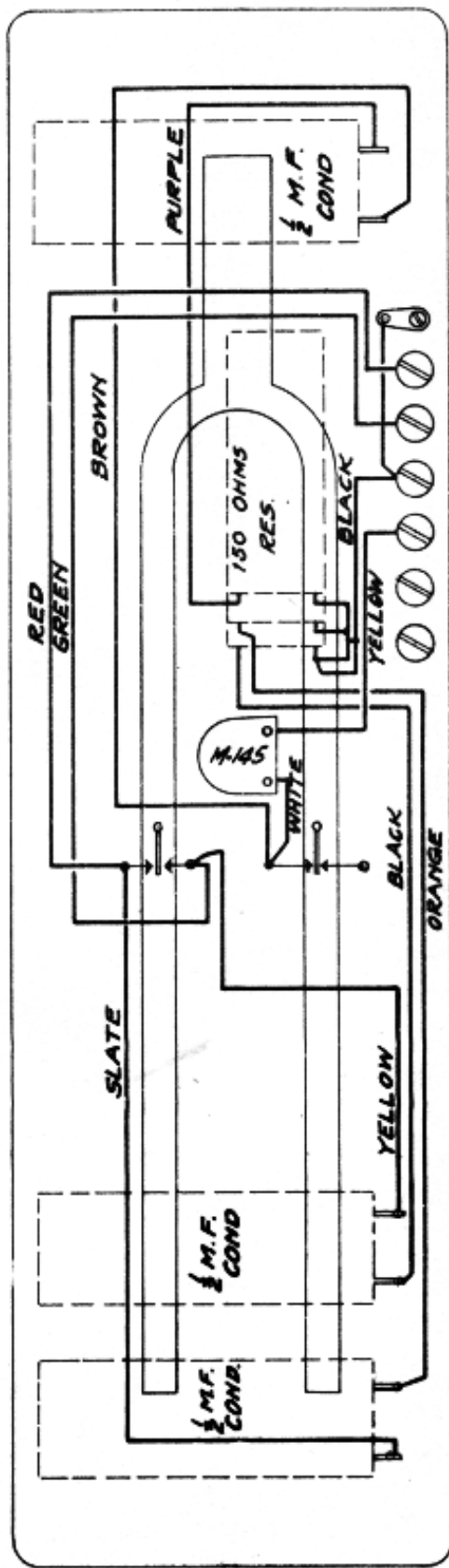

MORKRUM CO.
417
 DECEMBER 12, 1921

WIRING DIAGRAM
 FOR FORK
XF1
 AND
XF2

DRAWN *A.S.S.*
 TRACED *M.S.S.*
 CHECKED *A.S.S.*
 ENG'R'D *A.S.S.*
 APPROVED *A.S.S.*

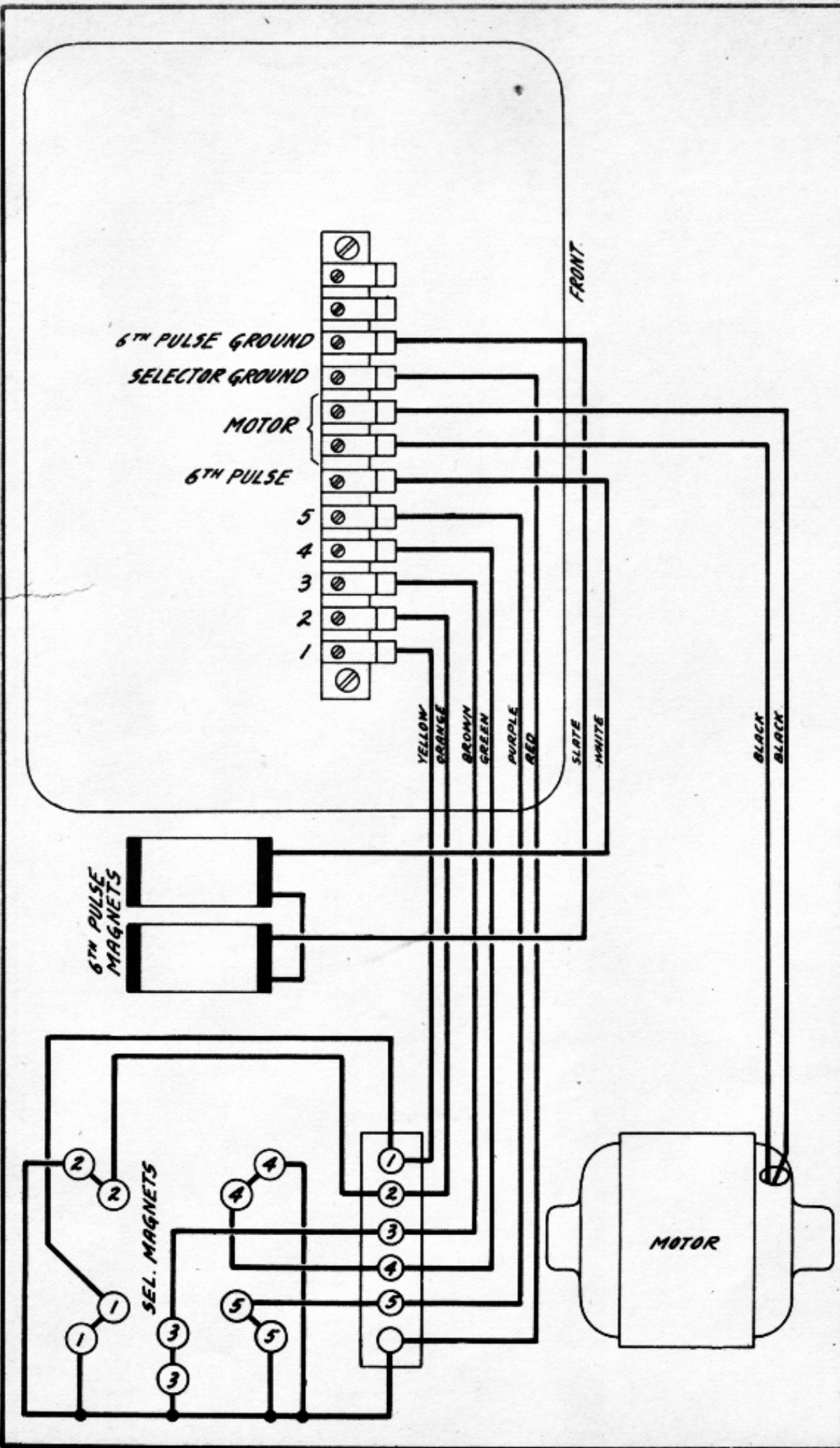

TELETYPE CORPORATION
 435
 APRIL 13, 1922.

WIRING DIAGRAM
 "TBP" PRINTER
 (WITHOUT GOVERNOR)

DRAWN A.S.B.
 TRACED A.D.
 CHECKED A.S.B.
 ENG'R'D A.S.B.
 APPROVED J.O.C.

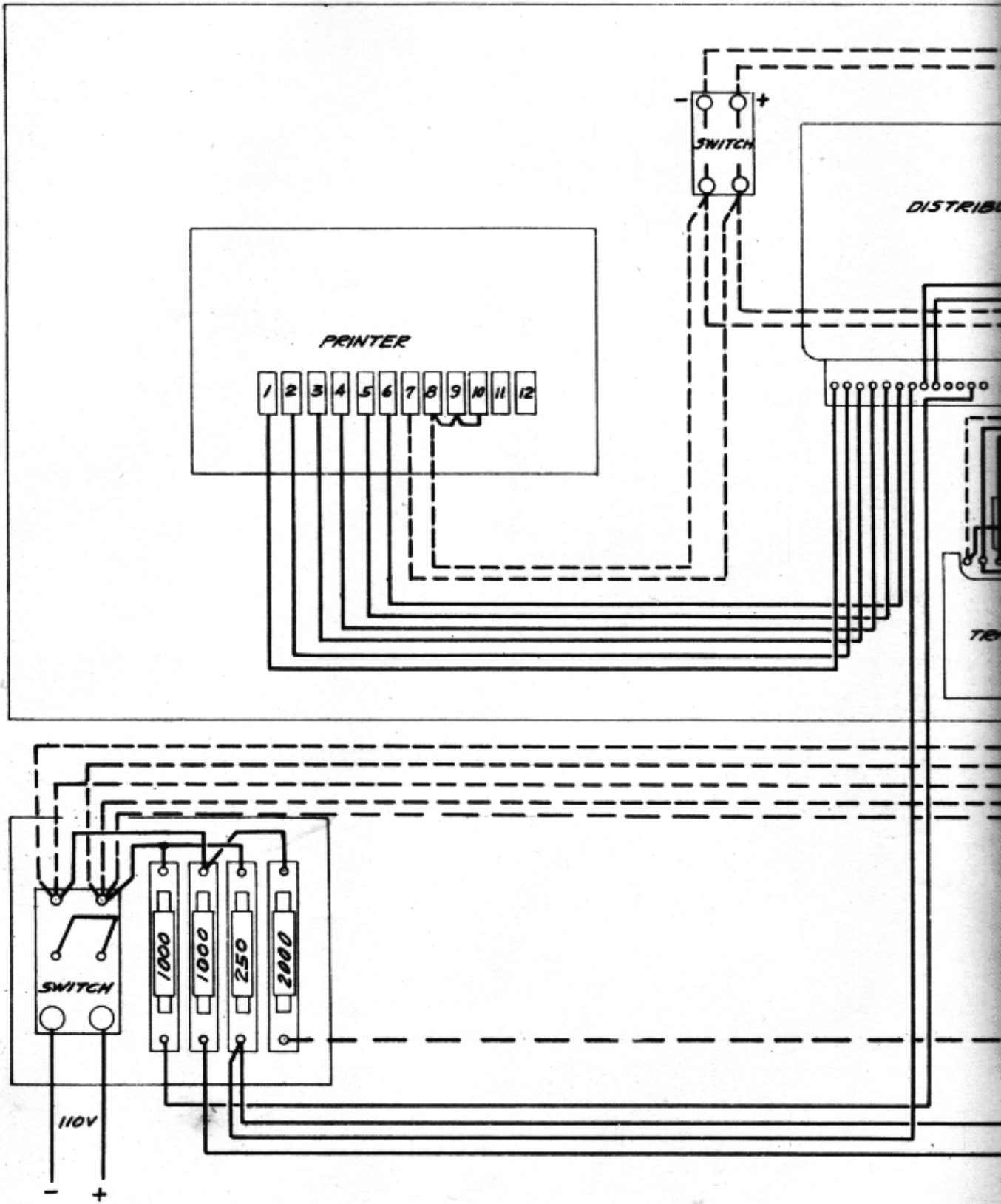

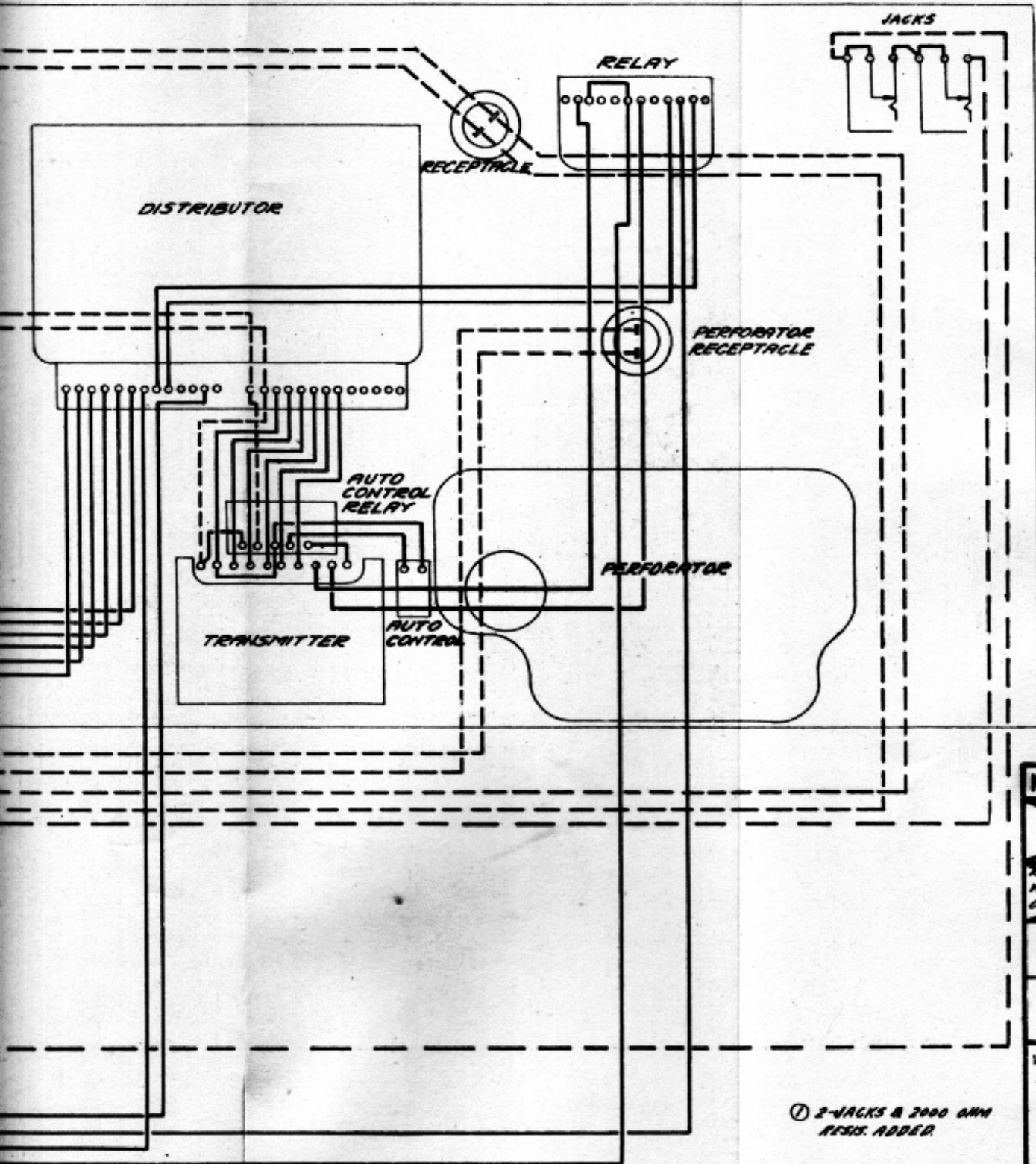

MORKRUM CO.
~~469~~
 JULY-22-1922
 REVISED: 11-20-22
 WIRES ON PINS 8, 9
 ON W. REVISED. A.S.B.
 469-A ①
 MAY-10-28

WIRING DIAGRAM
 FOR TABLE
MTT2

① 2 JACKS & 2000 OHM
 RESIS. ADDED.

DRAWN BY-A.S.B.
 TRACED BY-A.H.P.
 CHECKED BY A.S.B.
 APPROVED

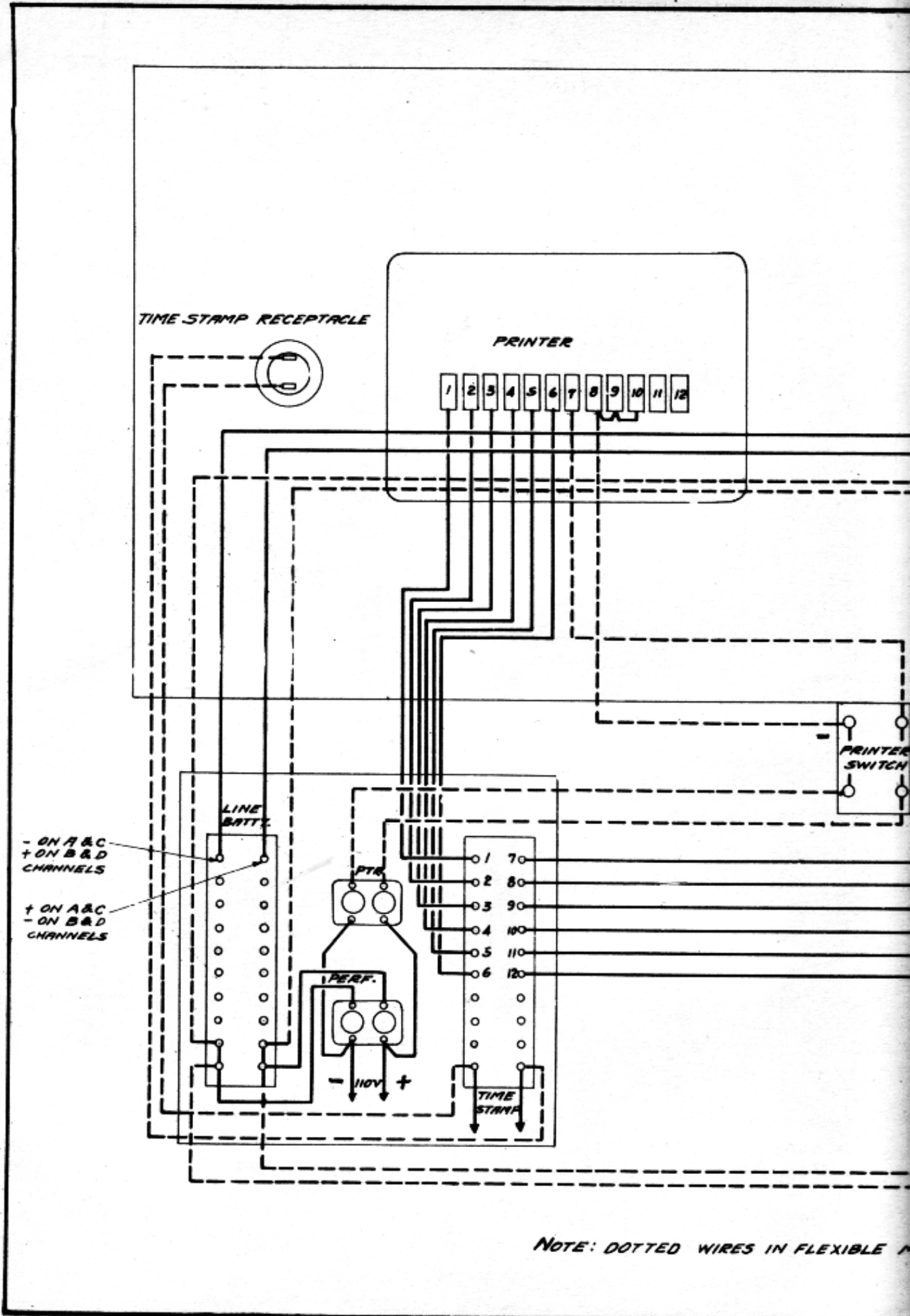

NOTE: DOTTED WIRES IN FLEXIBLE M...

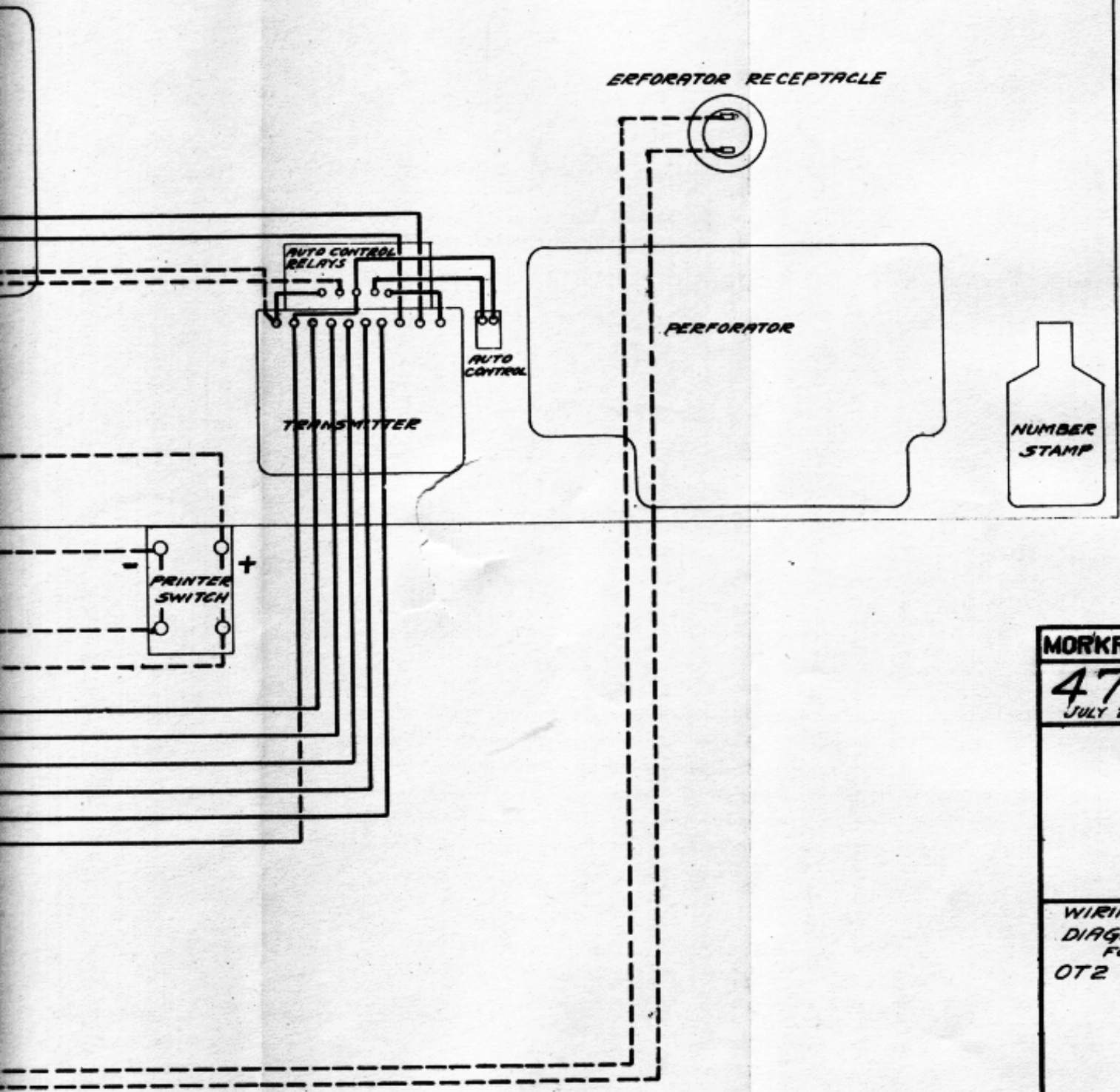

WIRES IN FLEXIBLE METALLIC CONDUIT

MORCRUM CO.
470
 JULY 22 1922

WIRING
 DIAGRAM
 FOR
 OT2 TABLE

DRAWN BY N.C.C.
 TRACED BY A.A.P.
 ENGINEER H.S.B.
 CHECKED BY A.S.P.
 APPROVED

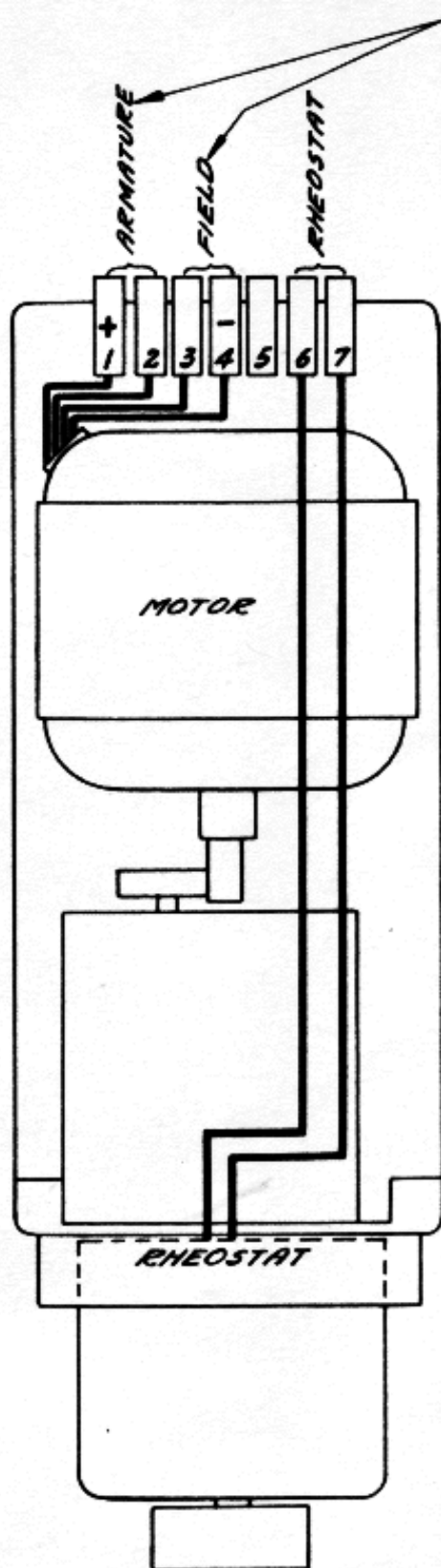

NOTE:

ARMATURE & FIELD WIRES SHOULD BE CONNECTED SO THAT MOTOR ROTATES IN A CLOCKWISE DIRECTION WHEN ARMATURE OF AUTO SPEED CONTROL RELAY IS HELD AGAINST ITS RIGHT HAND CONTACT.

IF NO DISTRIBUTOR TABLE IS AVAILABLE ROTATION MAY BE CHECKED BY CONNECTING 110V. WITH POLARITIES AS SHOWN TO GIVE CLOCKWISE ROTATION OF MOTOR LOOKING AT FRONT OF INSTRUMENT. CLIPS 2 & 3 SHOULD BE SHORTED

MORKRUM CO.

472

AUGUST 31, 1922

WIRING DIAGRAM
FOR ASC2
AUTOMATIC SPEED
CONTROL UNIT

DRAWN E.A.E.
TRACED E.F.R.
CHECKED
ENG'R'D
APPROVED

ASB

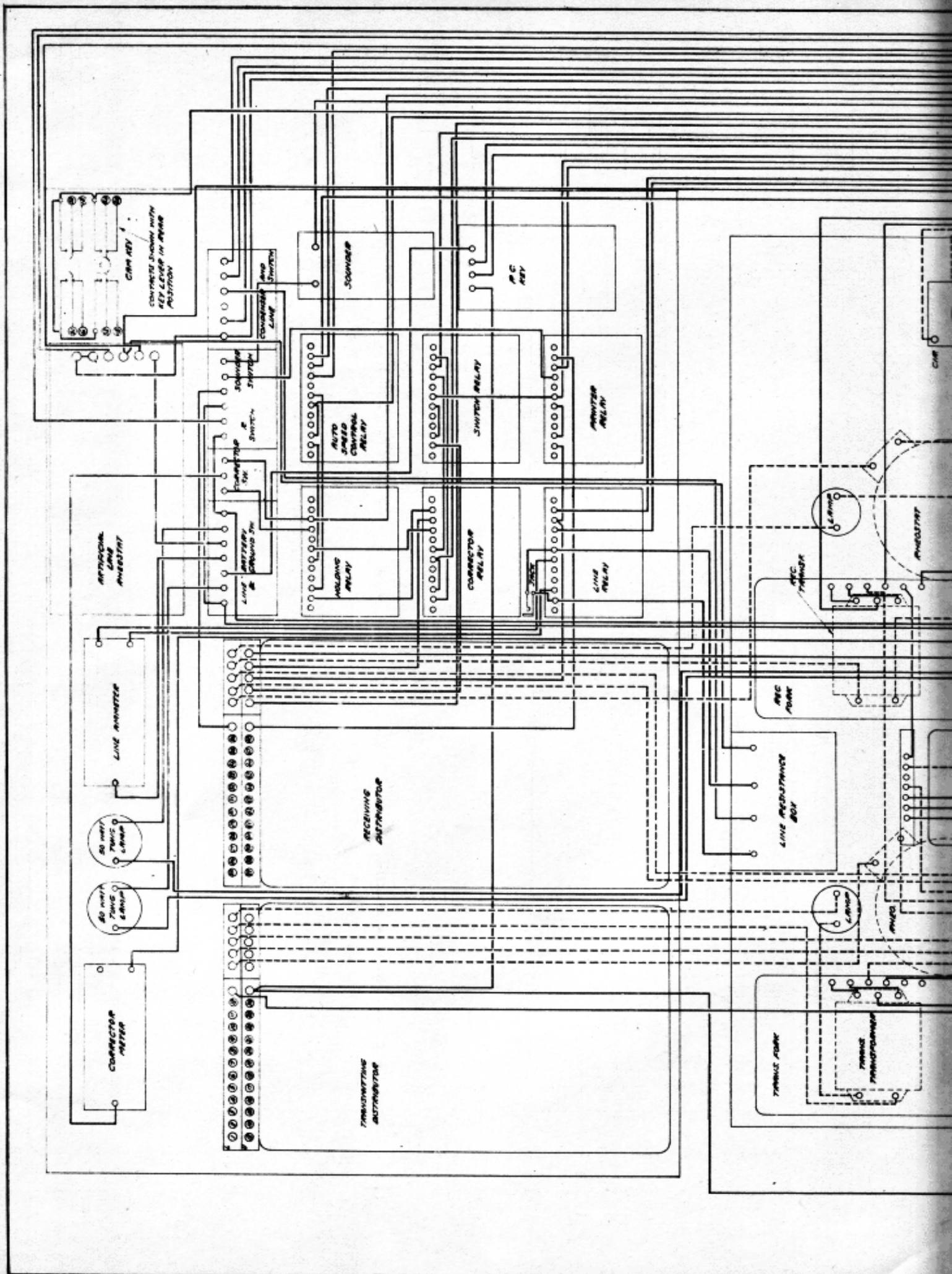

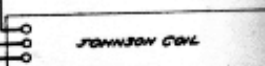
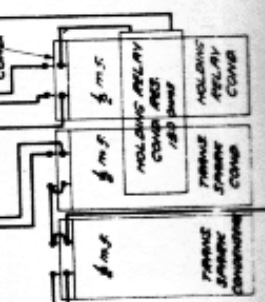
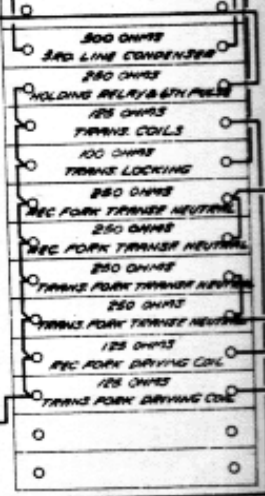
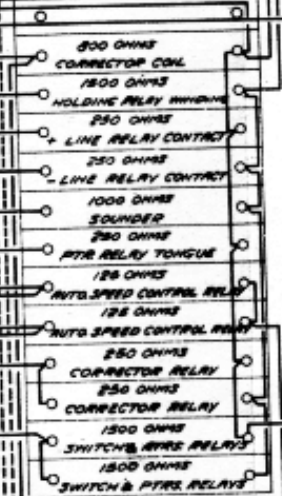
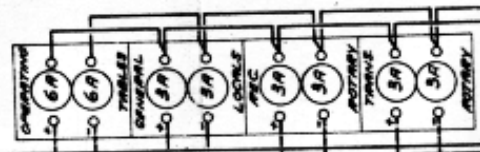
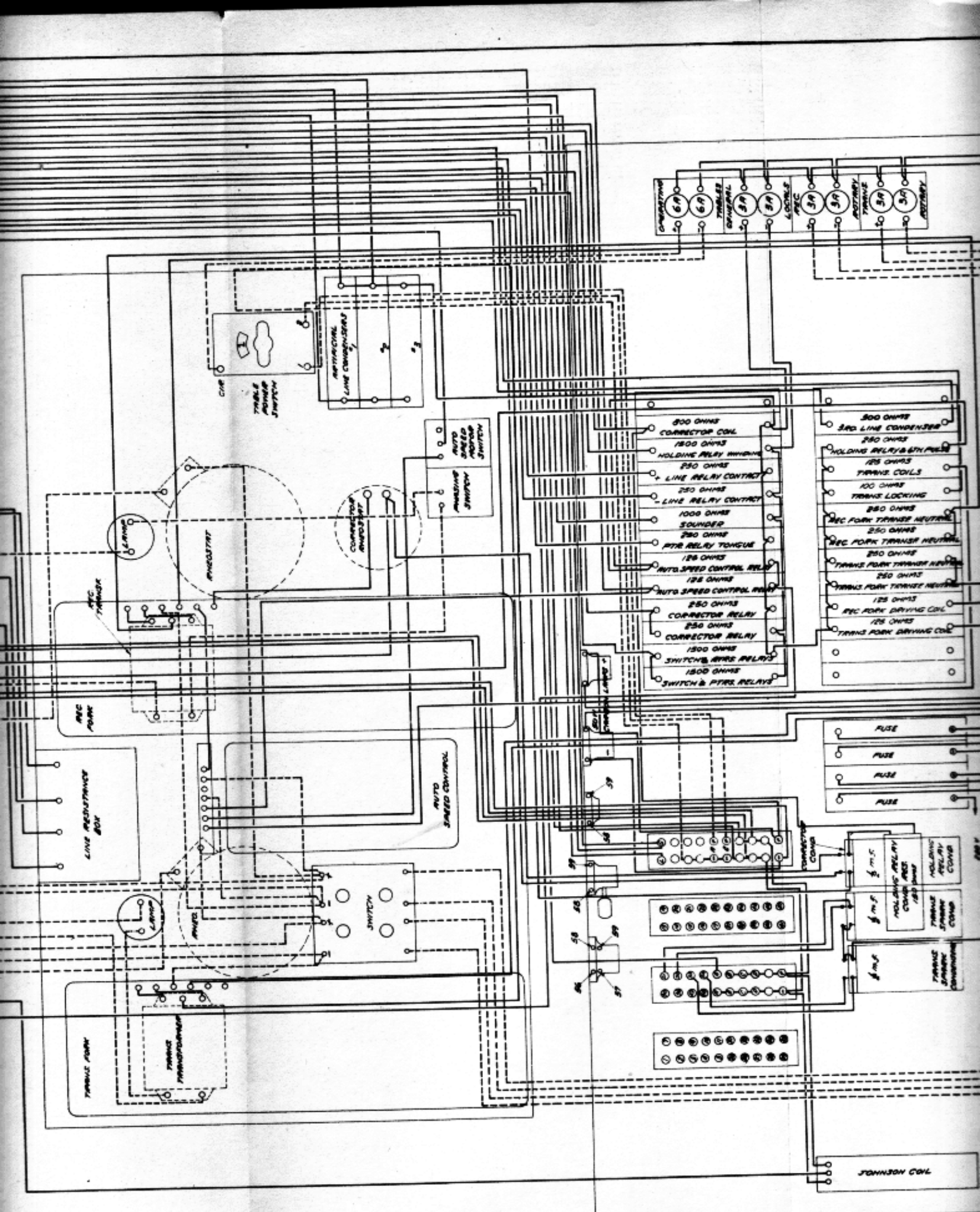

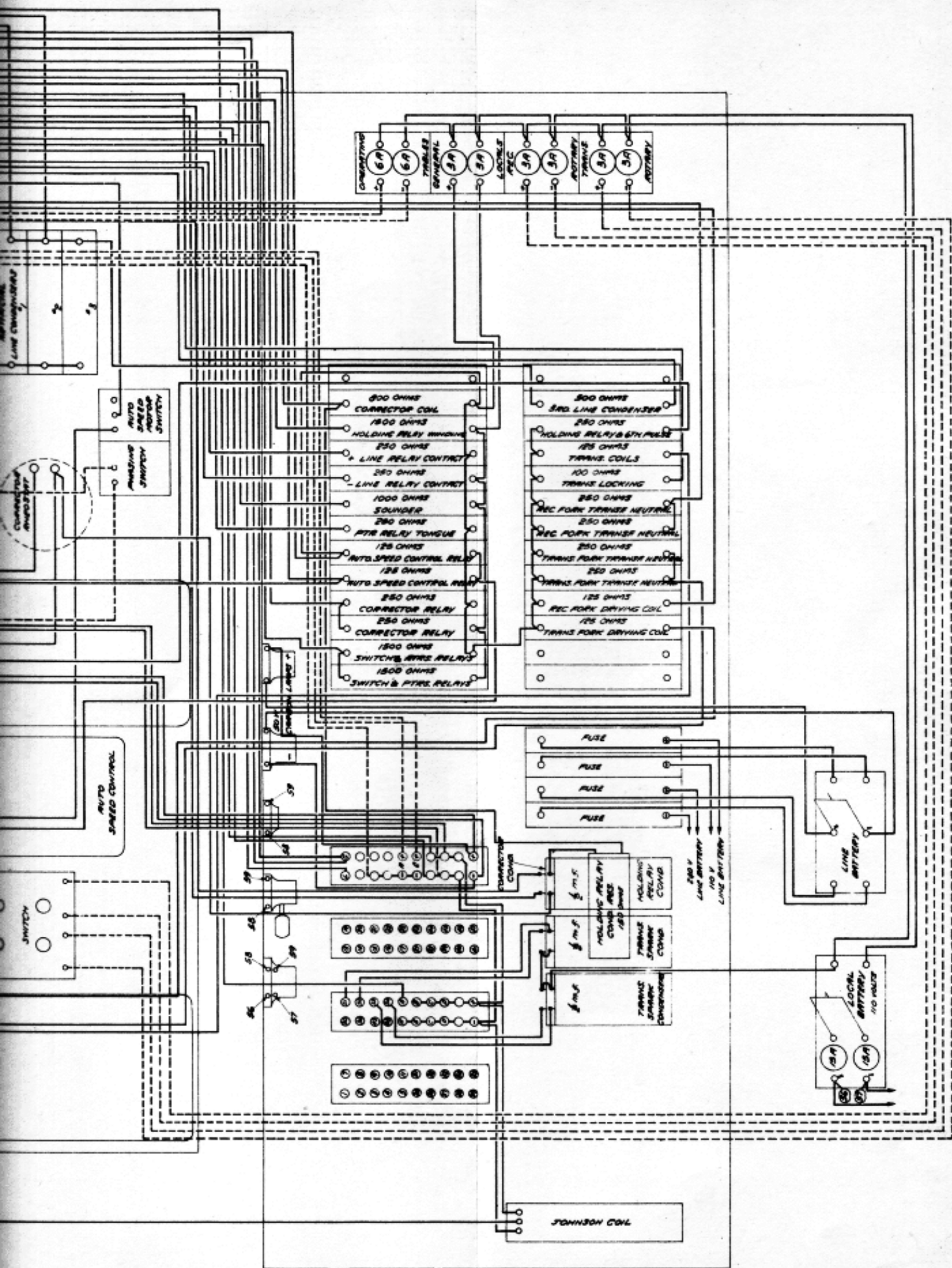

MORRUM CO.
 487
 SET 20 1922
 WIRING DIAGRAM
 MDT2
 TABLE
 REVISED:
 12-3-22 H.S.B.
 DRAWN BY [signature]
 TRACED BY [signature]
 CHECKED BY [signature]
 APPROVED BY [signature]

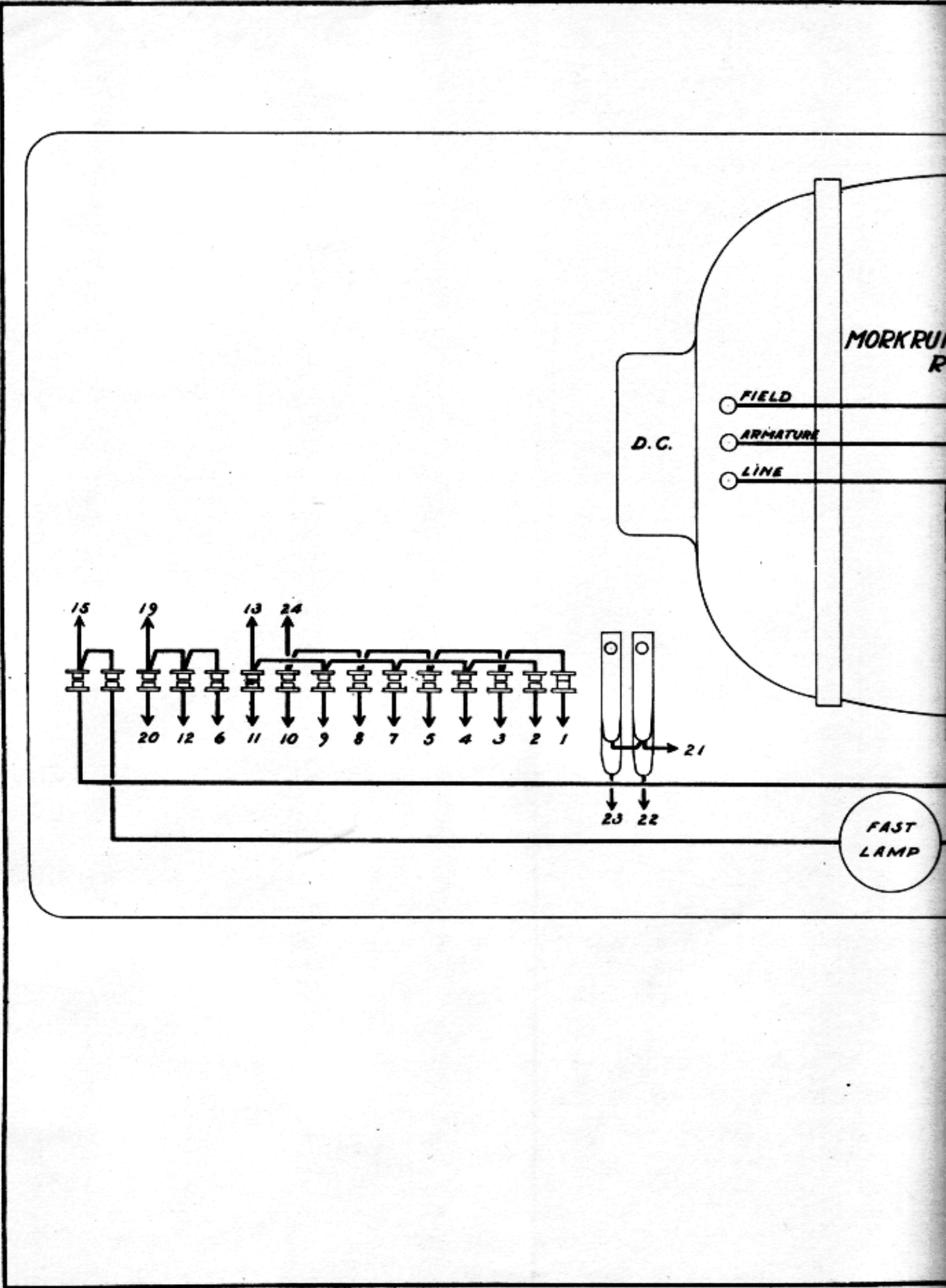

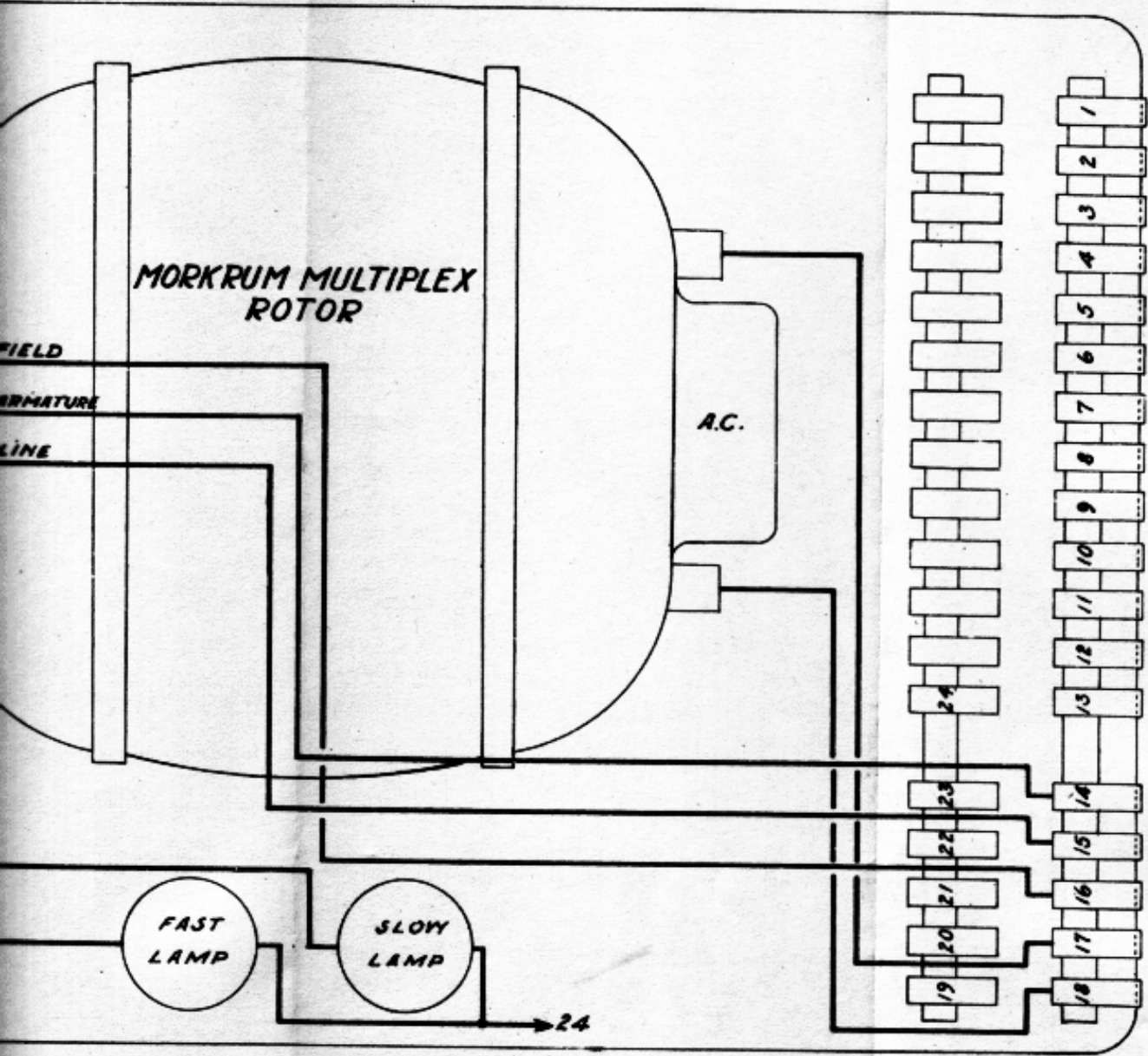

MORKRUM CO.
488
 OCT. 30, 1922

WIRING
 DIAGRAM
 M2CRD2
 DISTRIBUTOR

DRAWN R.A.E.
 TRACED H.S.H.
 CHECKED A.S.B.
 ENG'R'D
 APPROVED *A.B.*

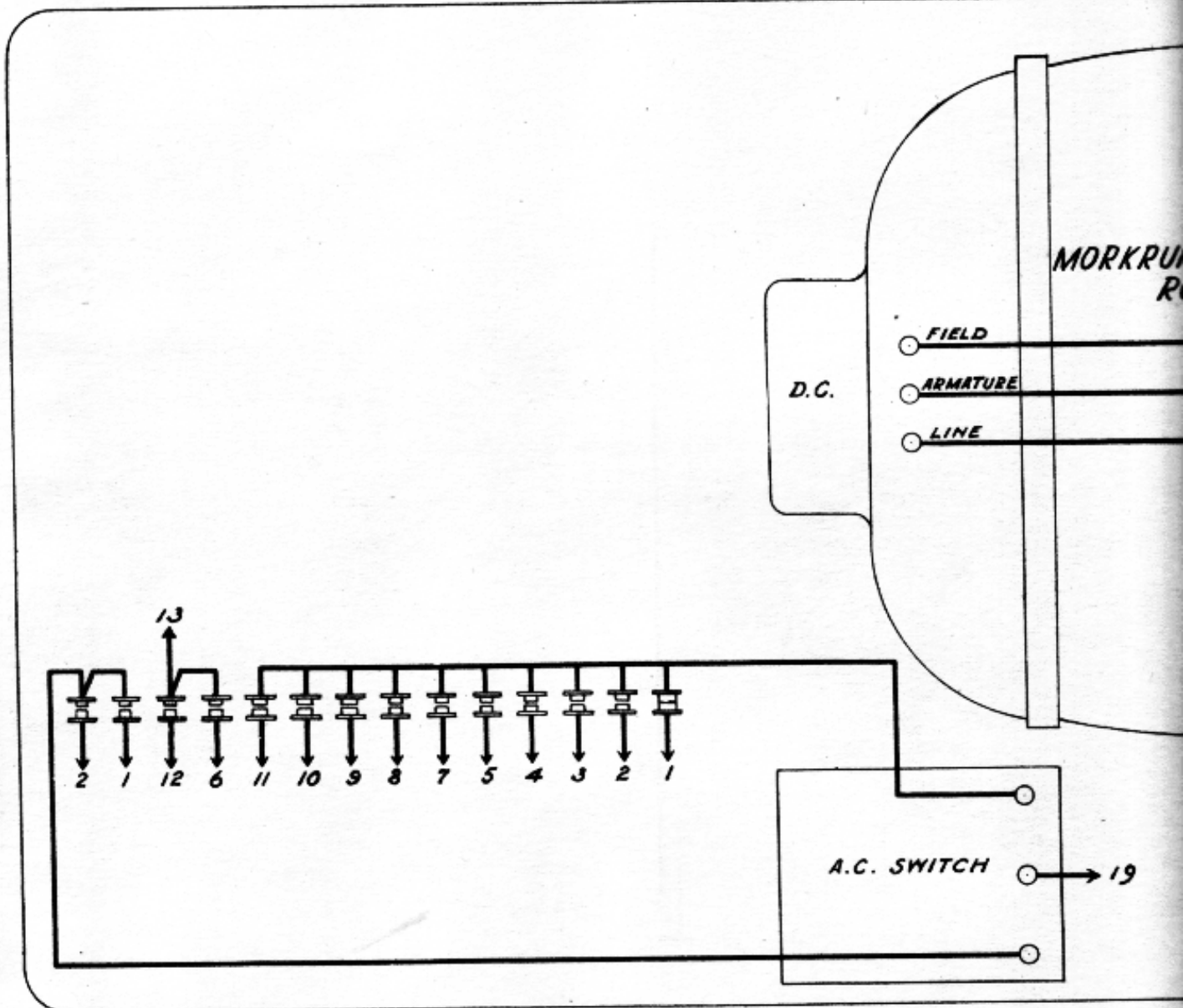

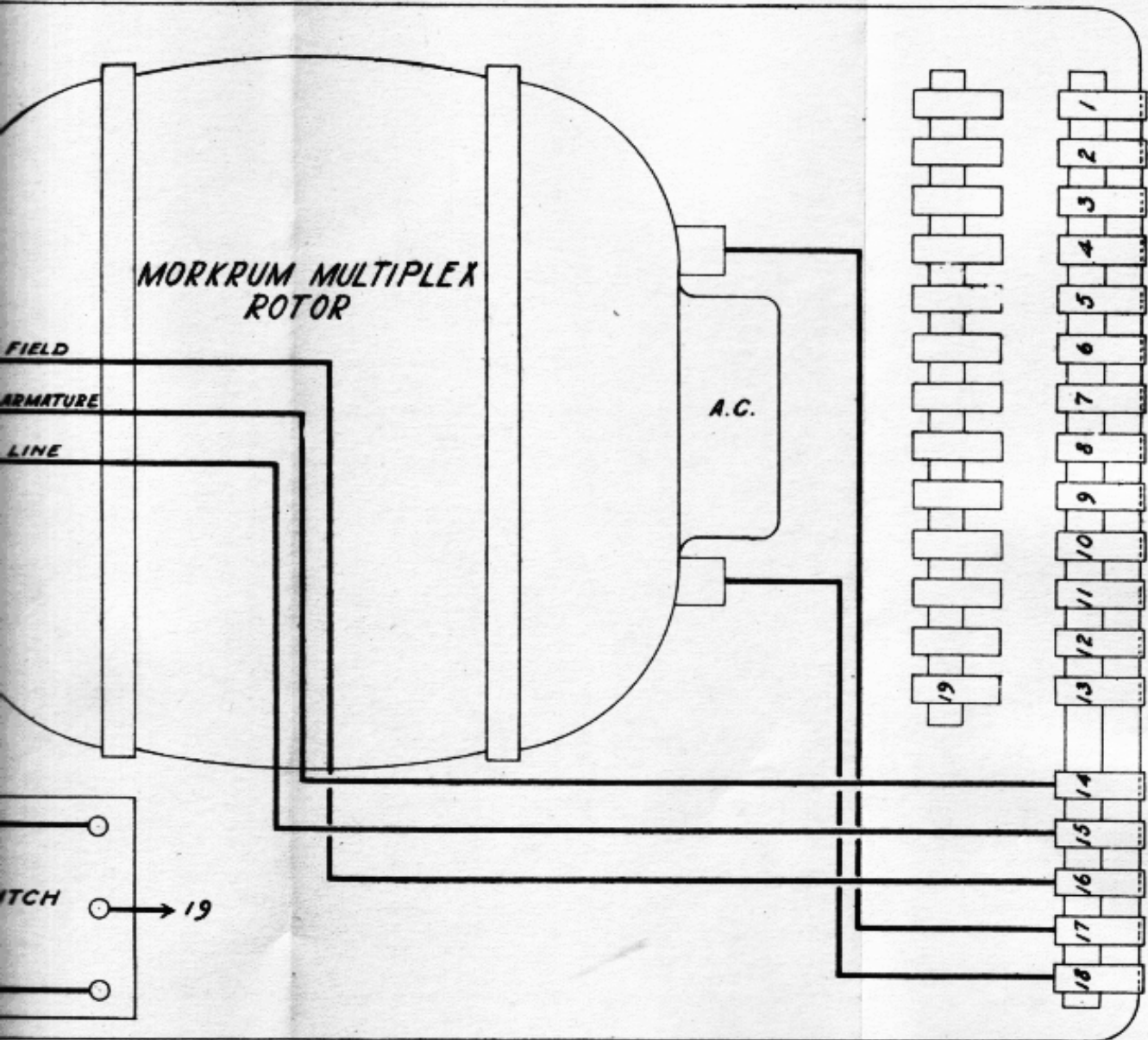

MORKRUM CO.

489
OCT. 30, 1922

WIRING
DIAGRAM
M2CXD2
DISTRIBUTOR

DRAWN P. A. E.
TRACED H. S. W.
CHECKED A. S. B.
ENG'R'D
APPROVED *A.S.B.*

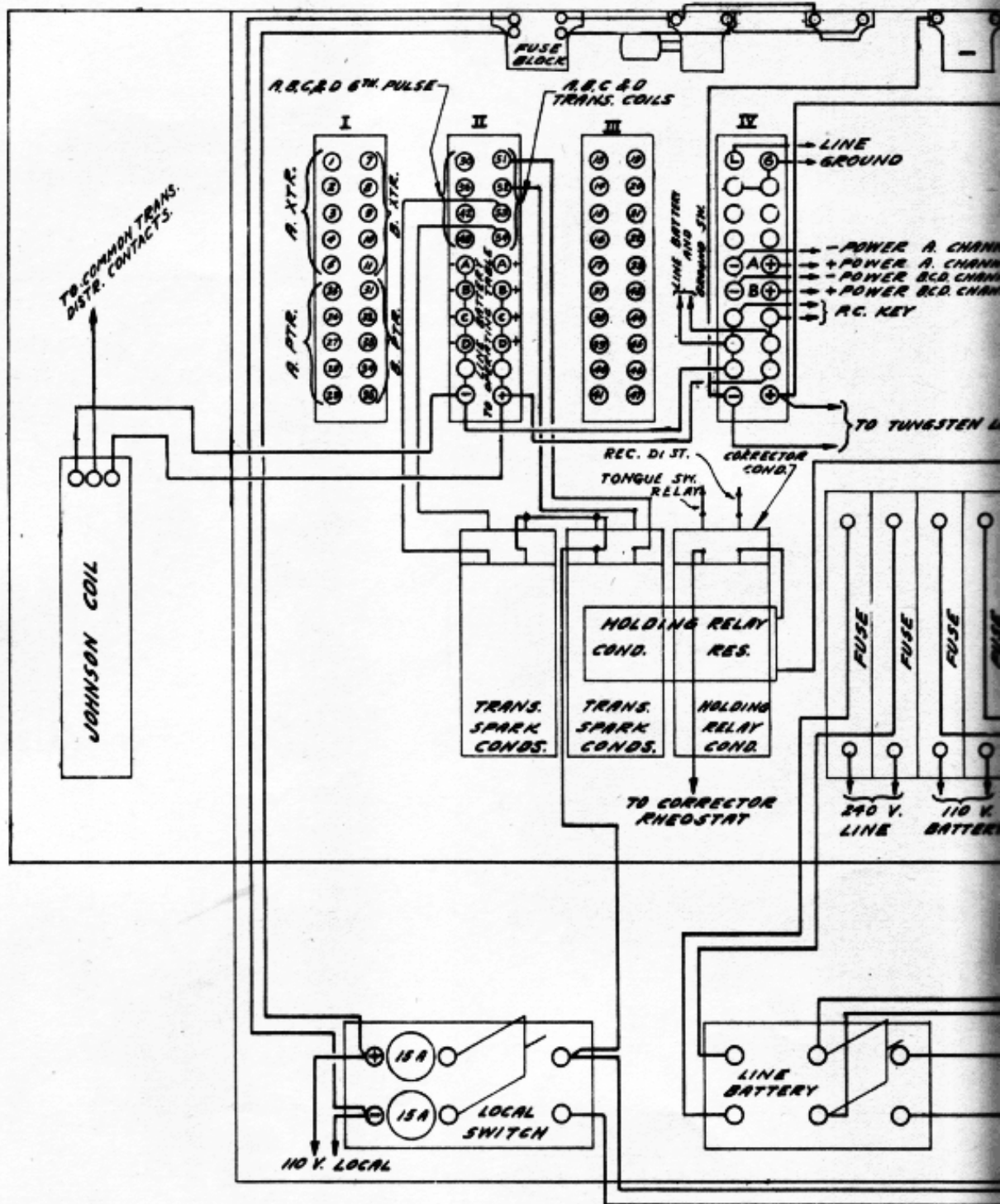

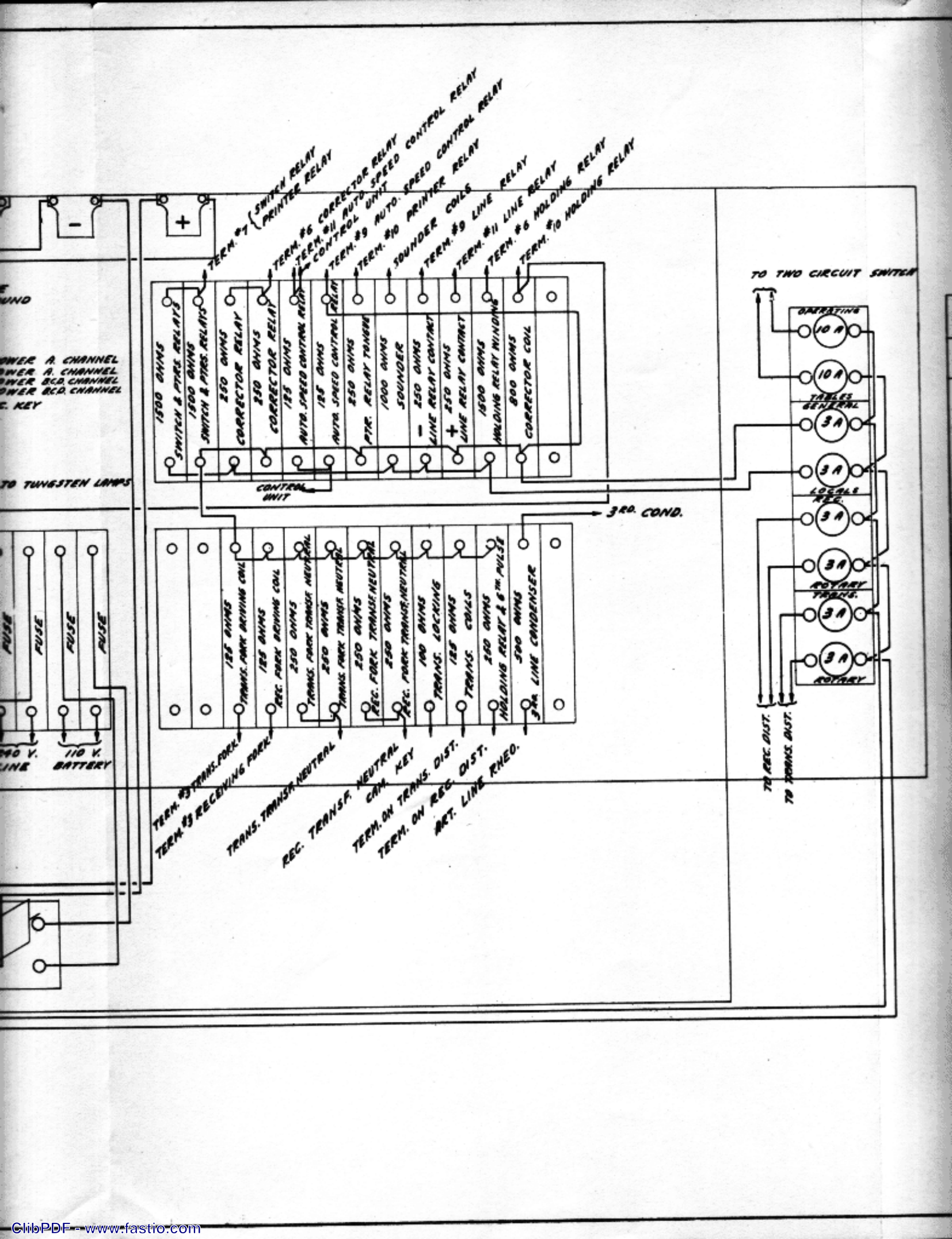

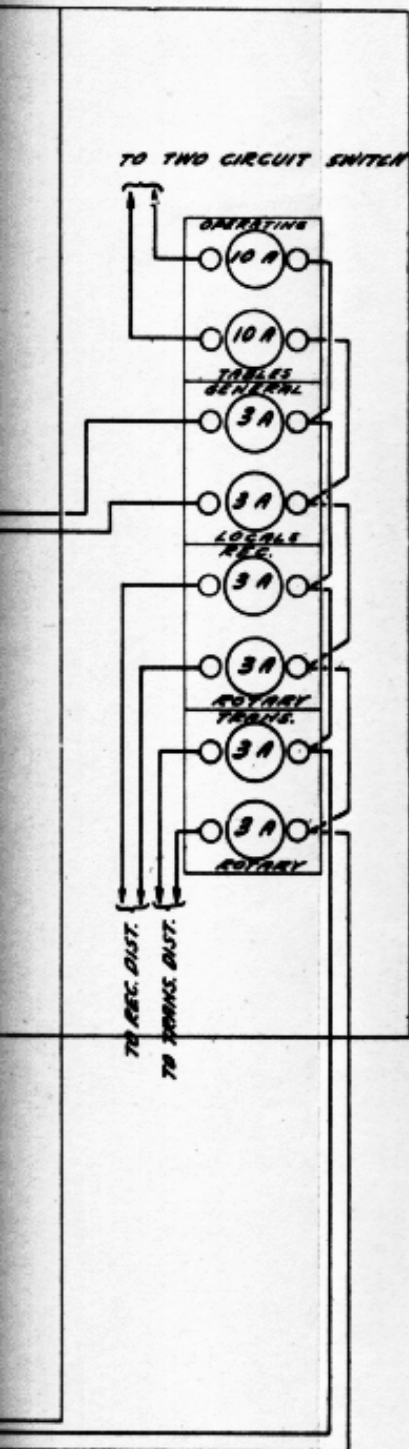

**CABLE CONNECTIONS
BETWEEN DISTRIBUTOR AND OPERATING TABLES**

A		B	
DISTRIBUTOR TABLE	CHANNEL OPER. TABLE	DISTRIBUTOR TABLE	CHANNEL OPER. TABLE
TRANS.	1 TO 7	TRANS.	7 TO 7
	2 - 8		8 - 8
	3 - 9		9 - 9
	4 - 10		10 - 10
	5 - 11		11 - 11
PTR.	51 - 12	PTR.	52 - 12
	25 - 1		31 - 1
	26 - 2		32 - 2
	27 - 3		33 - 3
	28 - 4		34 - 4
	29 - 5		35 - 5
30 - 6	36 - 6		
C		D	
DISTRIBUTOR TABLE	CHANNEL OPER. TABLE	DISTRIBUTOR TABLE	CHANNEL OPER. TABLE
TRANS.	13 TO 7	TRANS.	19 TO 7
	14 - 8		20 - 8
	15 - 9		21 - 9
	16 - 10		22 - 10
	17 - 11		23 - 11
PTR.	53 - 12	PTR.	54 - 12
	37 - 1		43 - 1
	38 - 2		44 - 2
	39 - 3		45 - 3
	40 - 4		46 - 4
	41 - 5		47 - 5
42 - 6	48 - 6		

LOCAL POWER CONNECTIONS FOR OPERATING TABLES
ARE FROM TERMINAL BLOCK II

LINE BATTERY CONNECTIONS FOR OPERATING TABLE
ARE FROM BLOCK II

-A & +A, -B & +B, -C & +C, -D & +D GOING TO
THE A, B, C & D CHANNEL TABLES RESPECTIVELY.
LINE AND GROUND CONNECTIONS ARE MADE ON
UPPER TWO TERMINALS OF BLOCK II;

MORCRUM CO.

490

OCT. 30 - 1922

WIRING DIAGRAM
MDT2
PANEL BOX

DRAWN BY H.M.M.
TRACED BY E.A.F.-K.R.
CHECKED BY
ENGR'D BY
APPROVED BY *A.P.*

W-WHITE
 R-RED
 G-GREEN
 S-SLATE
 BR-BROWN
 BL-BLACK
 P-PURPLE
 Y-YELLOW
 O-ORANGE

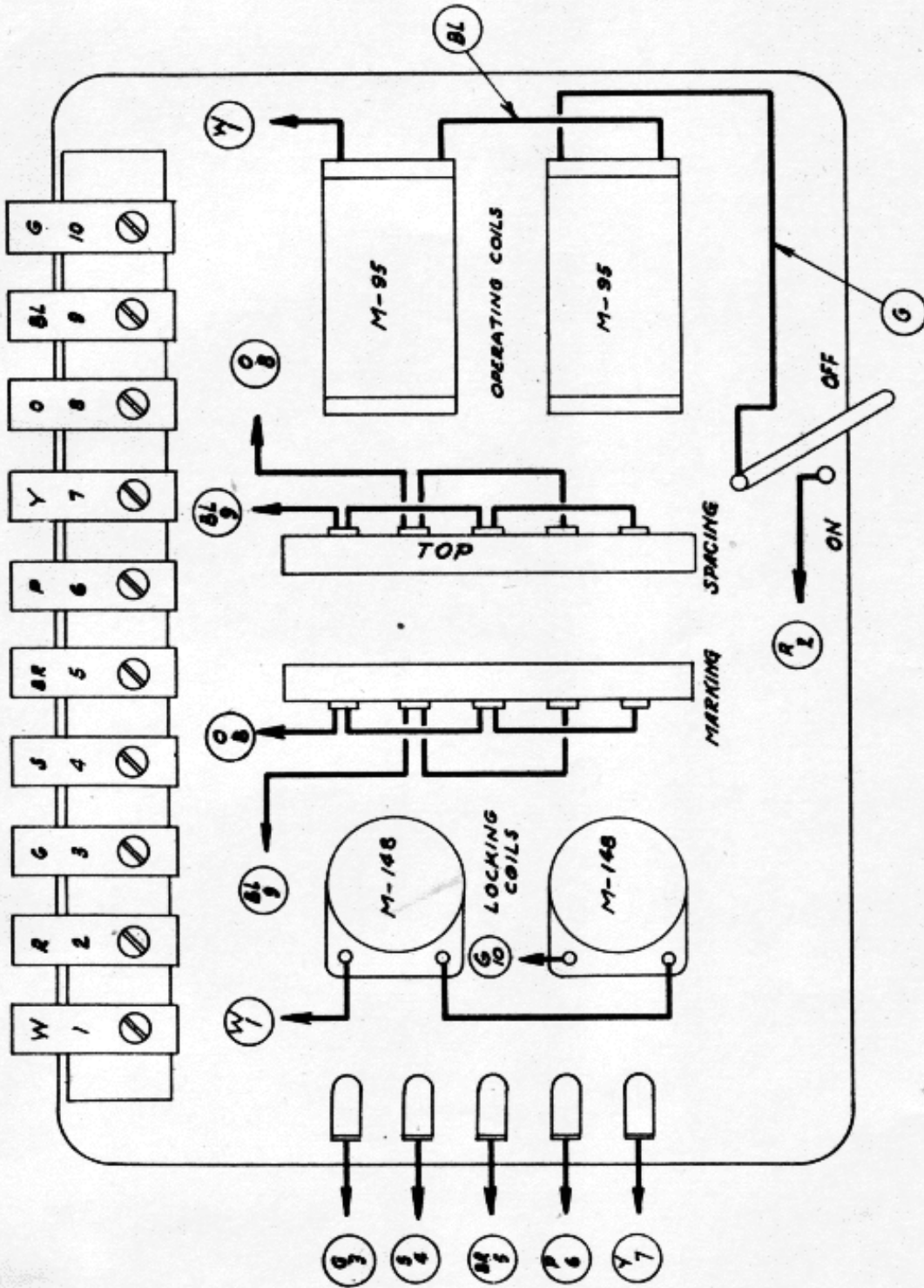

MORKRUM CO.	
#492	
DEC. 14-21	
REVISED	
11-9-22	H.S.H.
WIRING DIAGRAM FOR TRANSMITTER X1	
DRAWN: <i>ASB</i> TRACED: <i>WJH</i> CHECKED: <i>ASB</i> ENG'R'D: <i>ASB</i> APPROVED: <i>ASB</i>	

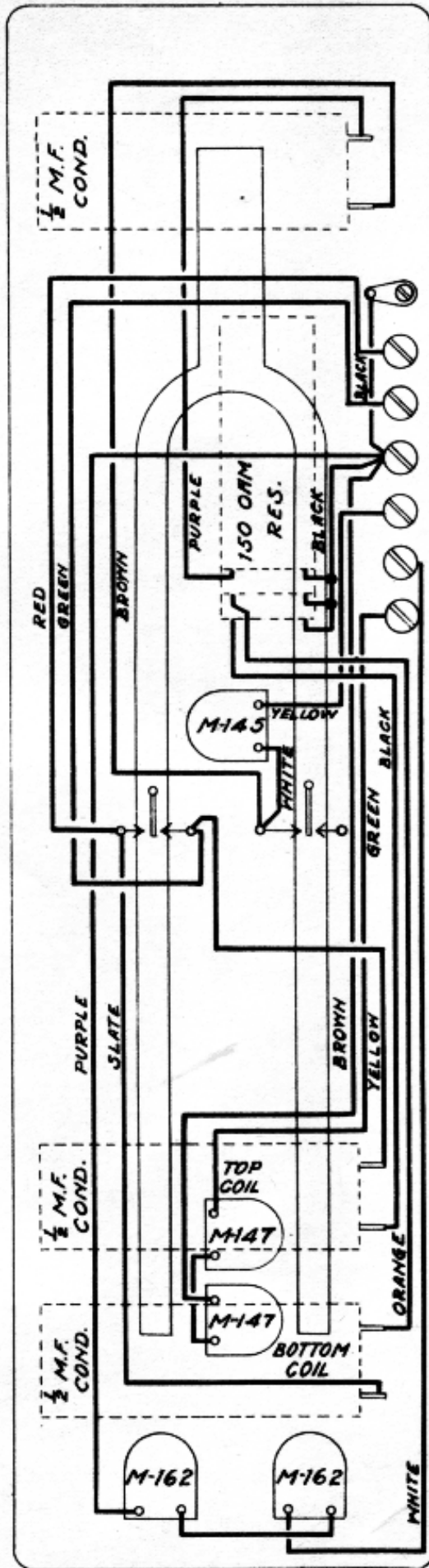

MORKRUM CO.

495

NOV. 13, 1922

WIRING
DIAGRAM
FOR FORK
RF 2

DRAWN A.S.B.
TRACED H.S.N.
CHECKED
ENG'R'D *A.S.B.*
APPROVED

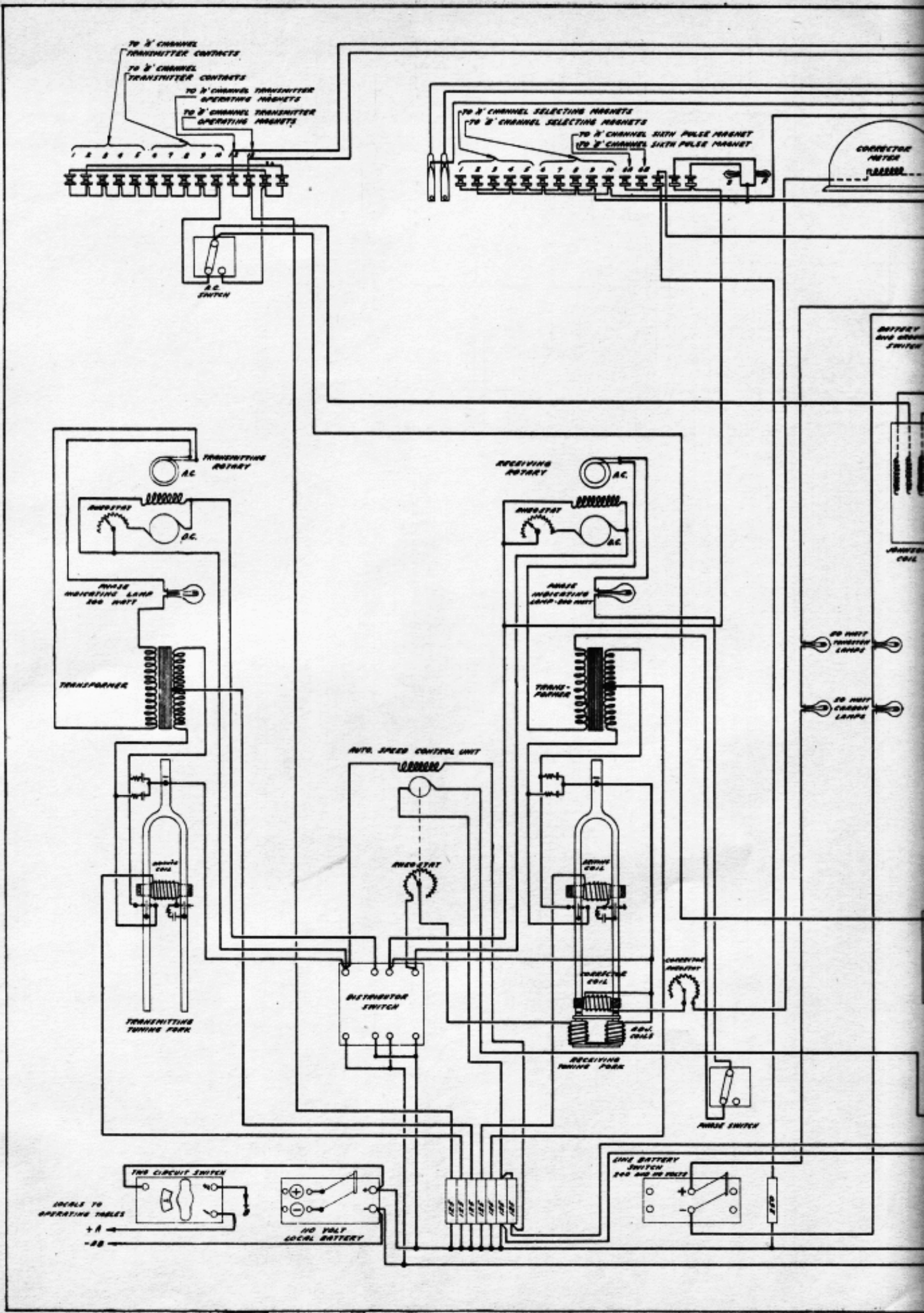

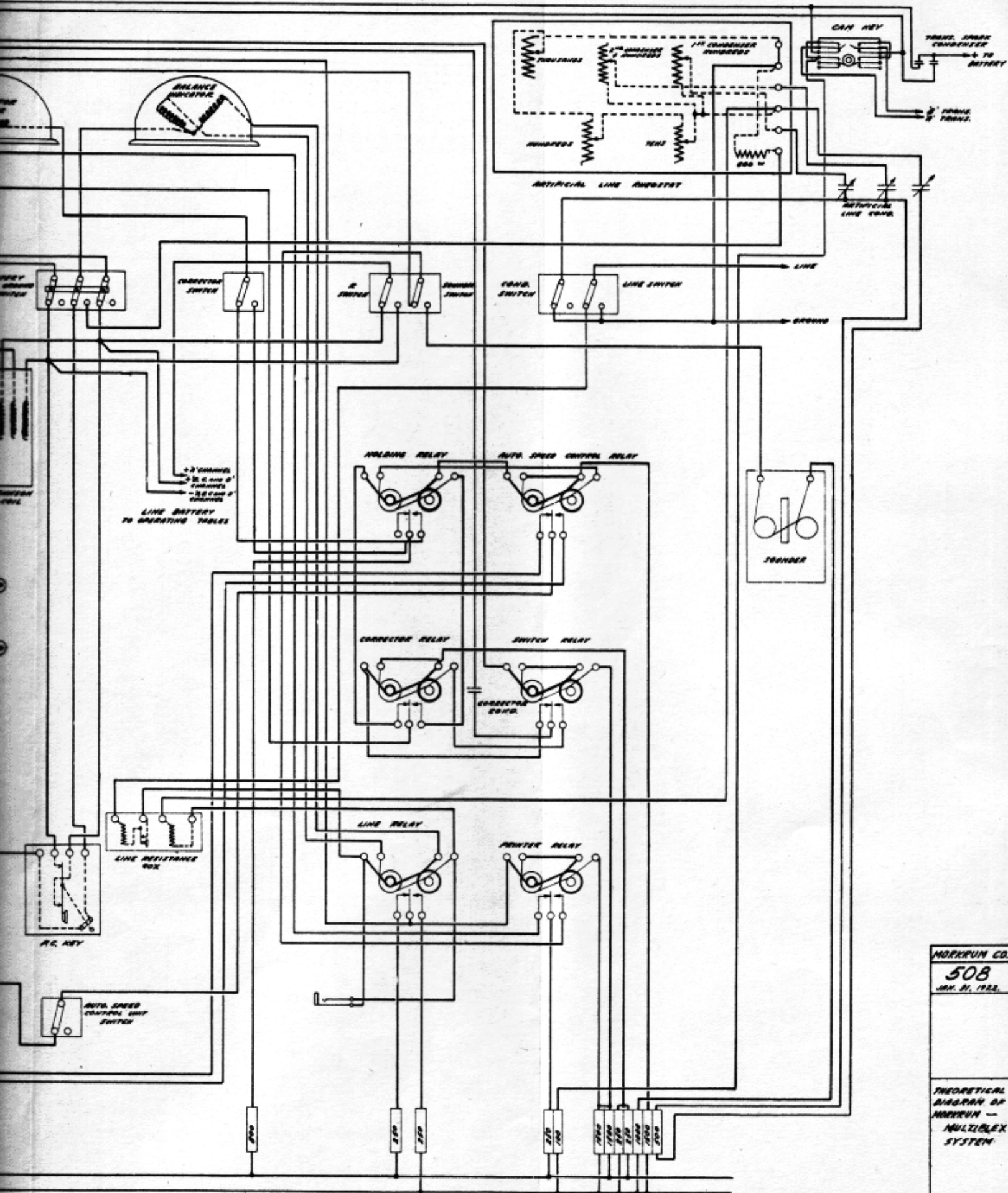

MORRUM CO.
 508
 JAN. 31, 1922.

 THEORETICAL
 DIAGRAM OF
 MORRUM -
 MULTIPLEX
 SYSTEM

 DRAWN BY H. E.
 PRICE & P. C.
 CHECKED
 ENG'G
 SANDED