

HIGH SPEED TAPE TO TAPE SYSTEM

TYPE 1 AND TYPE 2 TAPE SENDERS AND RECEIVERS

TEST, ADJUSTMENT, AND TROUBLESHOOTING GUIDE

| CONTENTS | PAGE |
|---------------------------------|------|
| 1. INTRODUCTION | 1 |
| 2. EQUIPMENT REQUIRED | 1 |
| 3. TROUBLE SHOOTING | 1 |
| GENERAL | 1 |
| FIGURES AND TABLES | 1 |

1. INTRODUCTION

1.01 This section provides tests, adjustments, and trouble shooting information for the high speed 1A, and 2A Tape Senders, and 1B and 2B Tape Receivers. Information is, for the most part, restricted to electronic components. Refer to separate sections for adjustment and lubrication information peculiar to the mechanical components (ie tape reader, tape punch and cabinets).

1.02 This section is reissued to revise the text, and waveforms. Since it is a general revision, marginal arrows ordinarily used to indicate changes and additions are omitted.

2. EQUIPMENT REQUIRED

2.01 The following special equipment is required to maintain and trouble-shoot the Tape Sender and Tape Receiver units.

Type 95555 test point signal monitor or equivalent oscilloscope (eg Tektronik 310A or 516, Packard Bell 5Mc2P, Hewlett-Packard 122AR)

Volt ohmmeter KS-14510 or equivalent

Extension test card TP-172450

Five level Mylar test tape TP-146605

Eight level Mylar test tape TP-146606

Circuit Card Kit and Case TP-146540

Pretested data set

NOTE: Refer to instruction material supplied with the test point signal monitor or oscilloscope for proper operating procedure and calibration.

3. TROUBLE SHOOTING

GENERAL

3.01 Trouble shooting information in this section is restricted to the Tape Senders and Tape Receivers. For information regarding the associated data set equipment, refer to the sections supplied with that equipment.

3.02 The checkout procedures given in the appropriate Installation and Checkout Procedures section may be used as a preliminary trouble shooting test to localize troubles to a general area.

FIGURES AND TABLES

3.03 The following figures and tables are provided to simplify adjusting and trouble shooting.

- Figure 1, Test Point Locations
- Table A, Tape Sender - Electronic Tests and Adjustments
- Table B, Tape Receiver - Electronic Tests and Adjustments
- Figure 2, Tape Sender - Trouble Shooting Flow Chart
- Figure 3, Tape Receiver - Trouble Shooting Flow Chart
- Tables C,D,E, and F, Tape Sender - Trouble Shooting
- Tables G,H,J, and K, Tape Receiver - Trouble Shooting
- Figure 4, Tape Sender - Electronic Block Diagram
- Figure 5, Tape Receiver - Electronic Block Diagram
- Figure 6, Tape Sender - Electronic Logic Diagram
- Figure 7, Tape Receiver - Electronic Logic Diagram
- Table L, Description of Logic Elements

3.04 Note that each of the Tape Sender and Tape Receiver trouble shooting tables is peculiar to a specific trouble symptom. These symptoms and associated tables are as follows:

Tape Sender

- Complete failure - Table C
- No signal output - Table D
- Level failure - Table E
- Garbled message - Table F

Tape Receiver

- Complete failure - Table G
- Not punching tape - Table H
- Garbled message - Table J
- Dropping or addition of marks and tape feed failure - Table K

3.05 In the Electronic Test and Adjustments, and Trouble Shooting tables, test points are identified (within a specific module) by two letters and a number (eg CM-2), or two letters followed by a third letter (eg CM-L). To locate the test point within the equipment pull out the specified module (eg Receiving Distributor) and locate the circuit card position specified, (CM for the example chosen). These card positions are lettered on the side of the module (see Figure 1). The number designation (2) refers to the numbered test terminal on the outside edge (opposite connector) of the card in the specified (CM) position. Test leads having small alligator clips can be connected directly to these numbered test points. A letter designation (L) following the card position letters (CM) refers to the lettered connection points on the inside (connector) edge of the card. To gain access to these terminals use the TP-172450 extension card as shown in Figure 1.

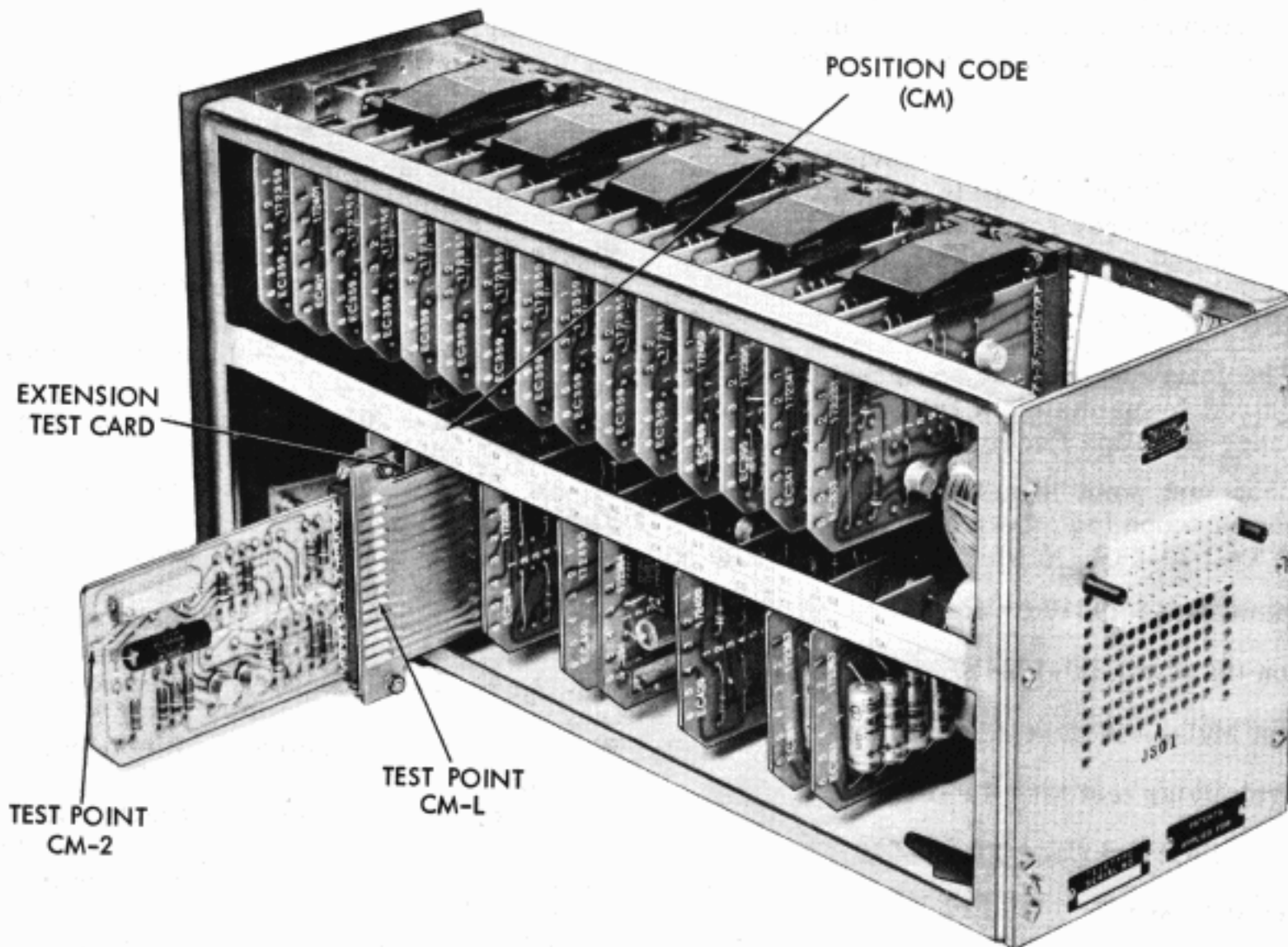
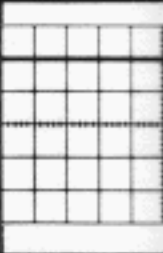



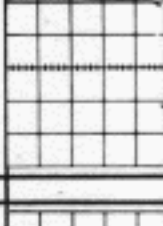
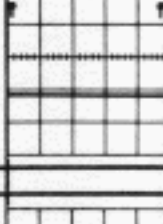



Figure 1. Test Point Locations

| Test No. | Signal Monitor Selector Switch Setting | TRIGGER Setting for Scopes | General Purpose Oscilloscope Setting | | Signal Test Points in Tape Sender | | Trigger Test Points in Tape Sender | |
|----------|--|----------------------------|--------------------------------------|-------|-----------------------------------|------------------|------------------------------------|------------------|
| | | | H | V | Sending Distributor | Signal Converter | Sending Distributor | Signal Converter |
| 1 | 4 | EXT + | 100 usec/D | 2 V/D | BD-1 | | BD-1 | |
| 2 | 7 | EXT + | 2 msec/D | 2 V/D | BQ-2 | | BD-1 | |
| 3 | 4 | INT + | 100 usec/D | 2 V/D | BN-2 | | | |
| 4 | 7 | EXT + | 2 msec/D | 2 V/D | BQ-2 | | BD-1 | |
| 5 | 4 | INT + | 100 usec/D | 2 V/D | BN-2 | | | |
| 6 | 4 | EXT + | 100 usec/D | 2 V/D | BF-1 | | BF-1 | |
| 7 | 6 | EXT + | 2 msec/D | 2 V/D | | BR-2 | | BR- |
| 8 | 6 | EXT + | 2 msec/D | 2 V/D | | CR-4 | | BR- |

TABLE A

Tape Sender-Electronic Tests and Adjustments

| Trigger Test Points in Tape Sender | | Requirements | Adjustments | Scope D |
|------------------------------------|------------------|---|---|---|
| Sending distributor | Signal Converter | | | |
| BD-1 | | Turn reader motor on and transmit all marks. Time out is between 850 to 900usec. | Adjust stop timer by variable resistor R11 on card BD(EC365). |  |
| BD-1 | | <ol style="list-style-type: none"> 1. Last cycle over shoots to about 1/2 to 3/4 down on negative cycle. 2. All cycles of operation are equal in amplitude. | <ol style="list-style-type: none"> 1. Make rough adjustment of oscillator by variable inductor L1 on card BQ (EC394) 2. Adjust feedback resistor R6 on card BQ(EC394). |  |
| | | Jitter of last advance pulse occurs on both sides of steady advance pulse. | Adjust frequency of oscillator by adjusting variable inductor L1 on card BQ(EC394) until the observed wave form appears as shown. It may be necessary to operate EXT switch several times to catch jitter. Jitter may not be present if frequency is off. |  |
| BD-1 | | Same as test 2-1. | Make fine adjustment of stop timer by variable resistor R11 on card BD(EC365). Recheck Step 1. |  |
| | | Second advance pulse is centered to jitter. | Touch up frequency by variable inductor L1 on card BQ(EC394). |  |
| BF-1 | | Time-out should be 475 ± 100 usec. | Rough adjustment of timing resistor R11 on card BF(EC473). |  |
| | BR-2 | Second pulse coincides with midpoint of scope. | Set wave form by adjusting horizontal position on scope. Proceed to Step 8 without further horizontal adjustment. |  |
| | BR-2 | The approximate midpoint of the contact closure should coincide with midpoint of scope. | To adjust, loosen pickup coil mounting screws on tape reader and position the pick-up coil until this condition is met. |  |

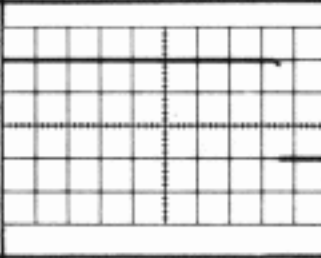
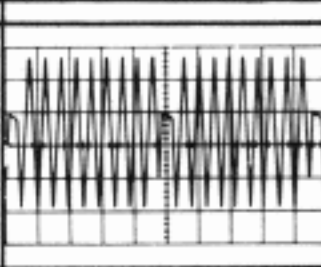
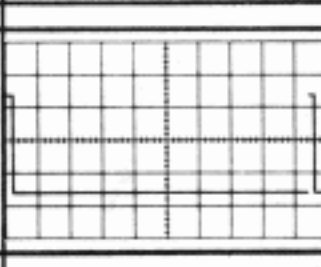
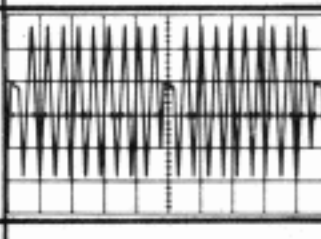
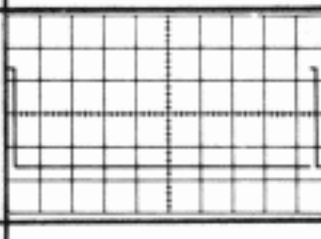
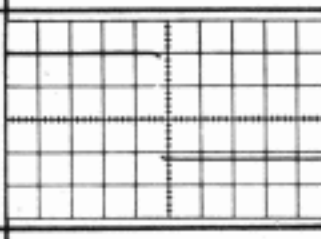
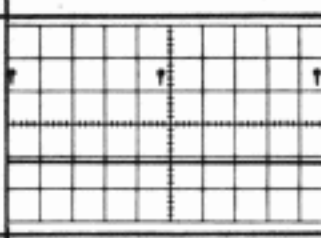
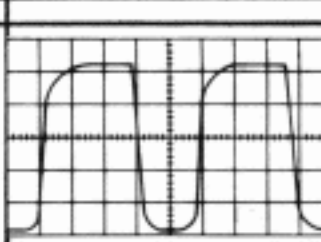
| | Adjustments | Scope Displays |
|----------------|---|---|
| ec. | Adjust stop timer by variable resistor R11 on card BD(EC365). |  |
| to n are | <ol style="list-style-type: none"> 1. Make rough adjustment of oscillator by variable inductor L1 on card BQ (EC394) 2. Adjust feedback resistor R6 on card BQ(EC394). |  |
| e eady | Adjust frequency of oscillator by adjusting variable inductor L1 on card BQ(EC394) until the observed wave form appears as shown. It may be necessary to operate EXT switch several times to catch jitter. Jitter may not be present if frequency is off. |  |
| | Make fine adjustment of stop timer by variable resistor R11 on card BD(EC365). Recheck Step 1. |  |
| n- | Touch up frequency by variable inductor L1 on card BQ(EC394). |  |
| 00 | Rough adjustment of timing resistor R11 on card BF(EC473). |  |
| h | Set wave form by adjusting horizontal position on scope. Proceed to Step 8 without further horizontal adjustment. |  |
| of | To adjust, loosen pickup coil mounting screws on tape reader and position the pick-up coil until this condition is met. |  |

| Test No. | Signal Monitor Selector Switch Setting | TRIGGER Setting for Scope | General Purpose Oscilloscope Setting | | Signal Test Points in Tape Receiver | | Trigger Points in Tape Receiver | |
|----------|--|---------------------------|--------------------------------------|-------|-------------------------------------|--|---------------------------------|------------------|
| | | | H | V | Receiving Distributor | Signal Converter | Receiving Distributor | Signal Converter |
| 1 | 4 | EXT - | 100 usec/D | 2 V/D | CF-2 | | CP-1 | |
| 2 | 7 | EXT + | 2 msec/D | 2 V/D | CH-2 | | CL-3 | |
| 3 | 4 | EXT - | 100 usec/D | 2 V/D | CP-1 | | CP-1 | |
| 4 | 4 | EXT - | 100 usec/D | 2 V/D | CF-2 | | CP-1 | |
| 5 | 6 | EXT + | 2 msec/D | 2 V/D | | CM-4 (level 1) CN-4 (level 2) CP-4 (level 3) CQ-4 (level 4) CR-4 (level 5) CS-4 (level 6) CK-4 (level 7) CL-4 (level 8) | | |
| 6 | 6 | EXT + | 2 msec/D | 2 V/D | | | CJ-4 | |
| 7a | 6 | INT + | 2 msec/D | 2 V/D | MOD. TRD603 CN-1 | | | |
| 7b | 4 | INT + | 100 usec/D | 2 V/D | MOD. TRD804 CN-1 | | | |

TABLE B

Tape Receivers-Electronic Tests and Adjustments

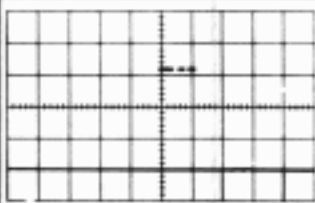
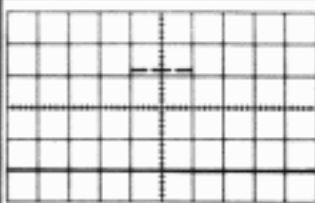
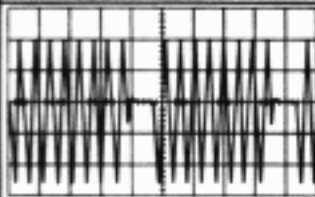
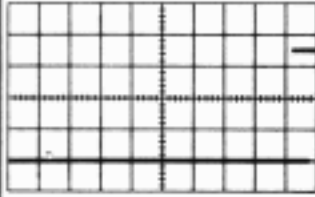
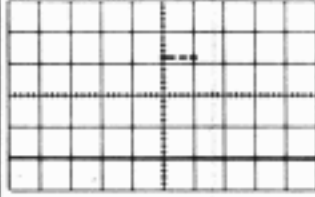
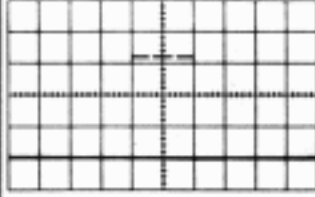
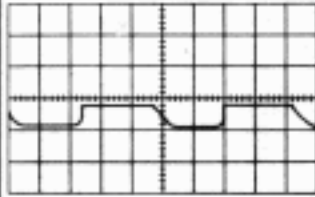
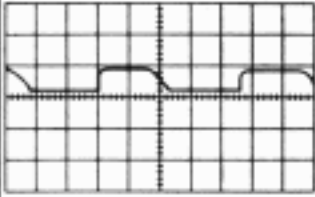
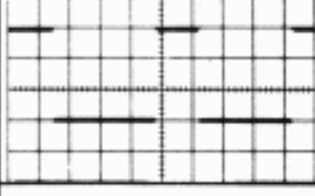
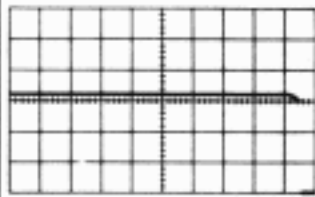
| al rter | Trigger Test Points in Tape Receiver | | Requirements | Adjustments | | | | | | |
|--|--------------------------------------|------------------|--|---|---|---|---|-------------------------------|-----------------------------|-----|
| | Receiving Distributor | Signal Converter | | | | | | | | |
| | CP-1 | | Receiving reversals consisting of (0, 2, 4, 6) marking adjust oscillator to 1050 cps $\pm 0.3\%$ frequency | Adjust frequency by variable inductor L1 on card CH(EC394). Note: Due to data set jitter the adjustment should center jitter pulses around steady pulse at scope center. |  |  | Frequency Too Low | Frequency OK | Fre | |
| | CL-3 | | All cycles of operation equal in amplitude. | Adjust feedback resistor of oscillator R6 on card CH (EC394). Recheck Test 1. | Type 2 display shown. For Type 1 subtract 3 cycles from each burst. |  | | | | |
| | CP-1 | | Proceed to Step 4 without changing scope setup. | Using horizontal control on scope, center trace so that it starts on far left grid line. | |  | | | | |
| | CP-1 | | Steady pulse occurs midpoint of scope. | Adjust start delay resistor R11 on card CM(EC473). | |  |  | Freq. OK Start Delay Too Long | Frequency OK Start Delay OK | Fre |
| Level 1) Level 2) Level 3) Level 4) Level 5) Level 6) Level 7) Level 8) | | CH-2 | The tape punch motor must be on and receiving all marks. Magnet pulsers should have respective time-outs of 4.5 ± 0.2 msec. Slight jitter is normal. | Adjust feedback resistor R5 on cards CM, CN, CP, CQ, and CR on Type 1 and in addition CS, CK, and CL on Type 2 (EC396). See *Note. | |  | | | | |
| | | CH-2 | The tape punch motor must be on and receiving all marks. Feed magnet pulser should have time-out of 5 ± 0.2 msec. Slight jitter is normal. | Adjust feedback resistor R5 on card CJ(EC396). See *Note. | |  | | | | |
| | | | Type 1 - Stop inserter should have time-out of 2.9 msec ± 0.1 msec. | Adjust resistor R11 on card CN(EC475). | |  | | | | |
| | | | Type 2 - Time-out 950 usec ± 100 usec. | Adjust resistor R11 on card CN(EC365). | |  | | | | |

ments

| Adjustments | | | |
|---|---|--|--|
| Adjust frequency by variable inductor L1 on card CH(EC394). Note: Due to data set jitter the adjustment should center jitter pulses around steady pulse at scope center. | | | |
| Adjust feedback resistor of oscillator R6 on card CH (EC394). Recheck Test 1. | Type 2 display shown. For Type 1 subtract 3 cycles from each burst. | | |
| Using horizontal control on scope, center trace so that it starts on far left grid line. | | | |
| Adjust start delay resistor R11 on card CM(EC473). | | | |
| Adjust feedback resistor R5 on cards CM, CN, CP, CQ, and CR on Type 1 and in addition CS, CK, and CL on Type 2 (EC396). See *Note. | | | |
| Adjust feedback resistor R5 on card CJ(EC396). See *Note. | | | |
| Adjust resistor R11 on card CN(EC475). | | | |
| Adjust resistor R11 on card CN(EC365). | | | |

*Note: Production tape punch units are adjusted to a standard optimum input signal of 4.5 msec with an expected operational tolerance requirement of approximately $\pm 8\%$ margin; ie, the unit will operate through an approximate range of 4.15 to 4.85 msec without readjustment of armature gap and/or spring tension. Field applications having control equipment generating signals other than that of an optimum 4.5 msec pulse length may therefore require refinement of the magnet armature adjustments and spring tensions to provide some operating margin of the pulse length being used.

COMPLETE FAILURE OR GARBLE MESSAGE

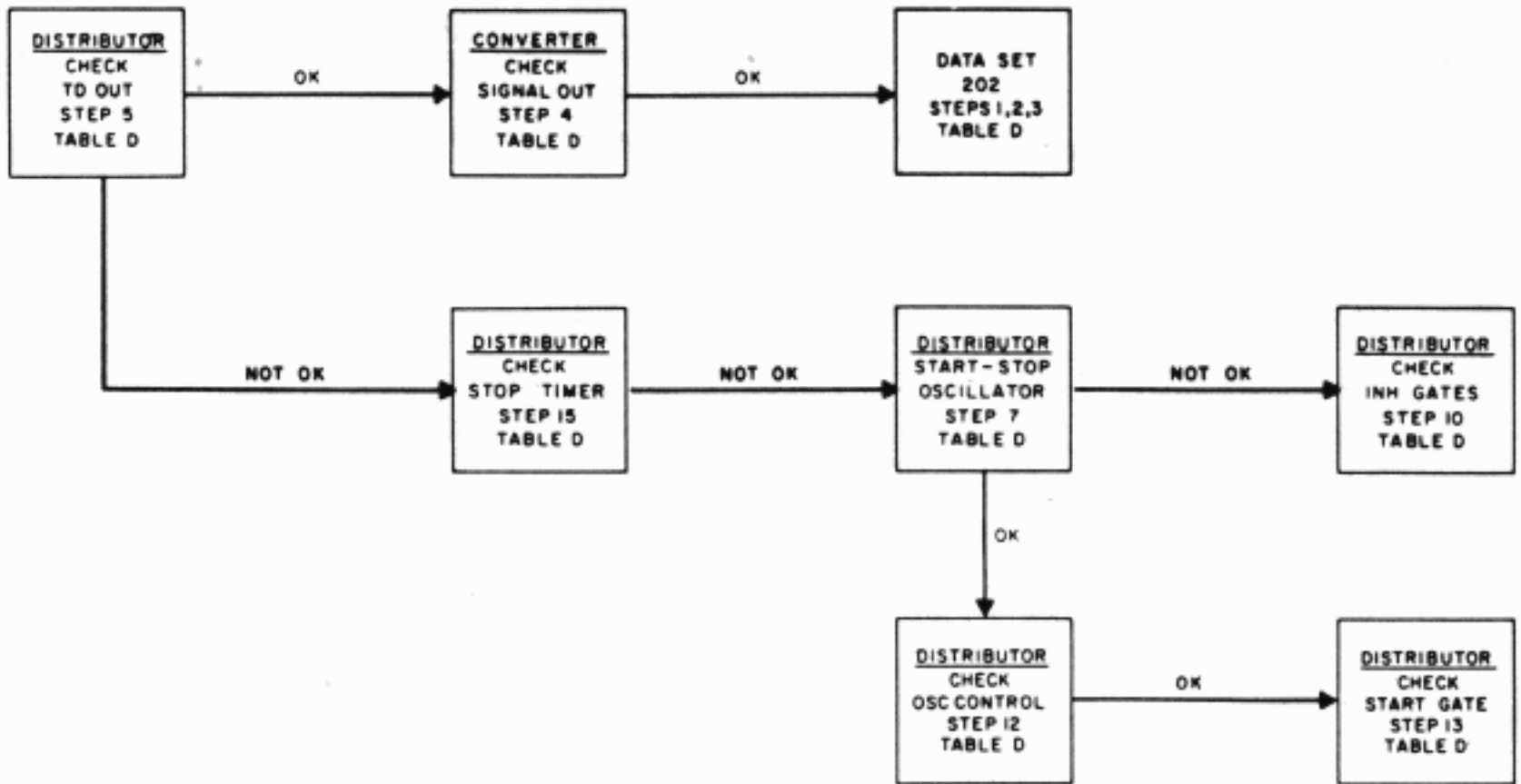

LEVEL FAILURE

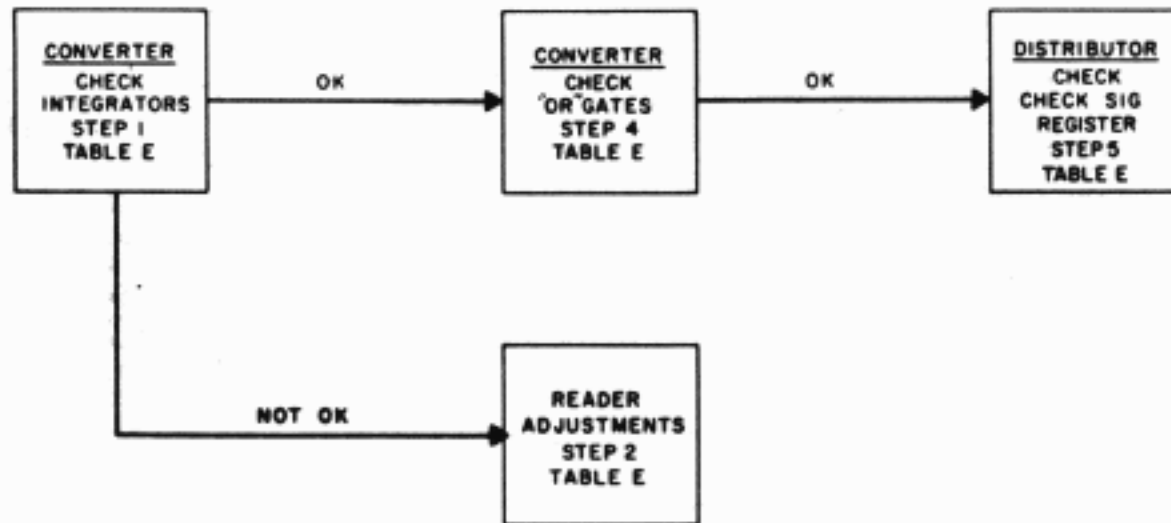
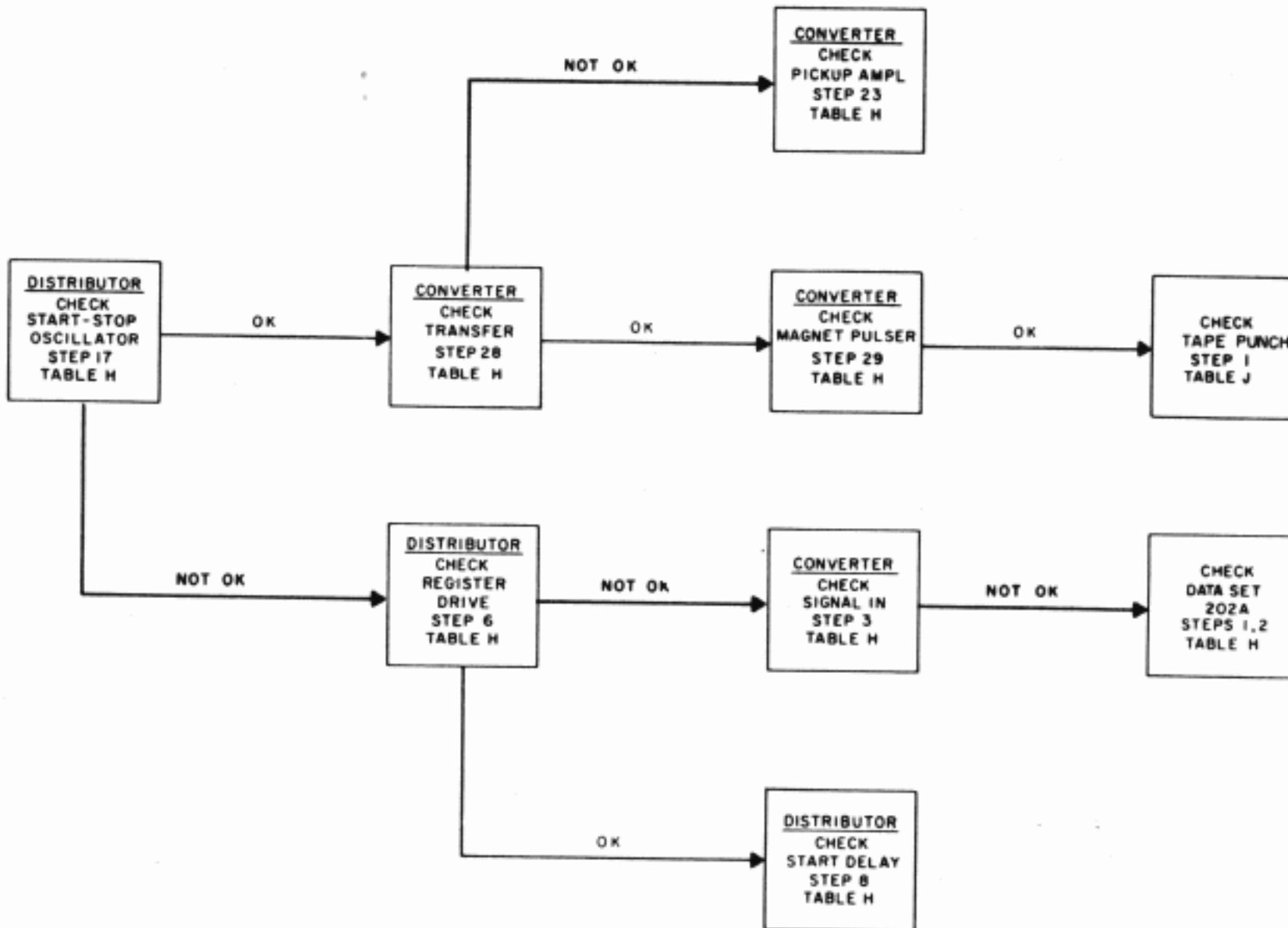

Figure 2. Tape Sender - Trouble Shooting Flow Chart

COMPLETE FAILURE OR GARBLED MESSAGE



LEVEL AND FEED FAILURE

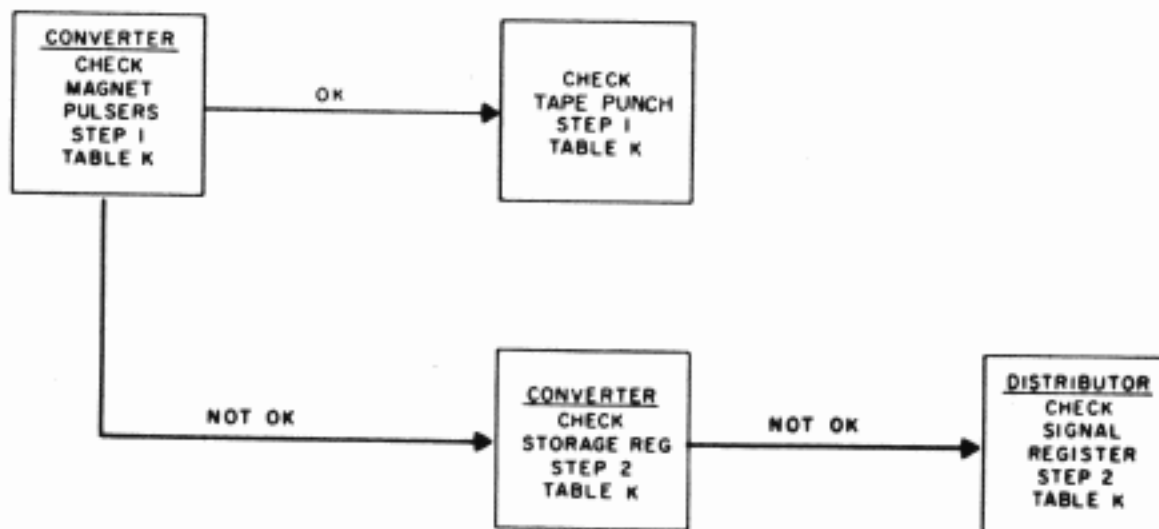

Figure 3. Tape Receiver - Trouble Shooting Flow Chart

TABLE C

Tape Sender-Trouble Shooting (Complete Failure)

| Symptom | Step | Action | Normal Indication and Procedure | Abnormal Indication and Procedure |
|---------------|------|--|---|---|
| Power failure | 1 | Check power lamp (yellow) on control panel. | Should be on. Proceed to 2. | Proceed to Step 2 or check modular power supply. Should be on. Check -28 volt dc supply. |
| | 2 | Check if reader and winder motor will operate when their respective switches are closed. | If motor operates, proceed to 3. | Proceed to 3. Check reset button on motor. |
| | 3 | With receiver off hook, place data set in data mode. | DATA lamp should light. Proceed to Step 9. | Check line fuses in cabinet. Proceed to 4. Check fuses in data set 202A. |
| | 4 | If Steps 1, 2, and 3 fail, check the following: Check for loose power connections. | All plugs should be in place. Proceed to Step 5. | Place plugs in proper receptacles and recheck Steps 1 through 3. |
| | 5 | With power removed, check loose or broken wires and possible short circuits using VOM. Refer to drawing. | If these check out, proceed to Step 6. | Correct and recheck Steps 1 through 3. |
| | 6 | Visual check of modular power supply. Check all dc voltages by operating voltage selector switch located on the power supply. Read the respective voltages on meter. | If all voltages are present, proceed to Step 7. | Zero indication signifies blown fuses. If -6R volt fuse is blown, this may indicate -8 volts on meter. Replace blown fuses and recheck. |
| | | Place tape in the reader. Place AUTO-MANUAL switch on MANUAL. | Tape reader should operate and sense tape. Proceed to Step 8. | Indicates no direct current to operating magnet. Check operating |

| | | | |
|--|---|---|--|
| | Steps 1 through 3. | | |
| check loose or broken wires and possible short circuits using VOM. Refer to drawing. | ceed to Step 6. | Zero indication signifies blown fuses. If -6R volt fuse is blown, this may indicate -8 volts on meter. Replace blown fuses and recheck. | |
| 5 | If all voltages are present, proceed to Step 7. | Visual check of modular power supply. Check all dc voltages by operating voltage selector switch located on the power supply. Read the respective voltages on meter. | |
| 6 | Tape reader should operate and sense tape. Proceed to Step 8. | Place tape in the reader. Place AUTO-MANUAL switch on MANUAL. Place start-stop lever in RUN position. Depress READER, button. Operate toggle switch located on automatic answer package in TEST position. | Reader or line break failure (when provided) |
| 7 | When test center comes back on line and is in data mode, reader should start automatically. Place reader lever in STOP. Alarm should go off. Upon disconnect from test center, LINE BREAK alarm and indicator lamp should go on and stop reader. | Call Data Test Center. With test tape in reader, depress READER and DATA buttons. Wait a moment and place start-stop lever in RUN. Request test center to call back. | Check of line break signal (when provided) |
| 8 | Check data set line break signal using VOM or signal monitor. Disconnect input to data set, ground test instrument on terminal 1 and place probe on line break output. Place call to test center and request test center data set to be in data mode. Line break output voltage should be $+8 \pm 1$ volt for ON, -8 ± 1 volt for OFF, or break condition. If normal, recheck with load applied (data set connected plugged in) and test instrument connected to signal ground or power supply and probe on test point 6 of automatic answer circuit card. Reading should be same as above. | | |

TABLE C (Continued)





Tape Sender - Trouble Shooting (Complete Failure)

| Symptom | Step | Action | Normal Indication and Procedure | Abnormal Indication and Procedure |
|---|------|---|--|--|
| Failure of motors to start when in automatic condition. | 9 | Place MANUAL-AUTO-MATIC switch in AUTO-MATIC. Place OPERATE-TEST switch in TEST. | Motors should start. Proceed to Step 11. | Visual A. Check motor start relay K to see if it is operating. B. Substitute circuit card and recheck Step 8. C. Check wiring and relay. D. Check dc supply voltage. |
| | 10 | Check relay driver amplifier. Disconnect interface on data set. VOM or scope can be used. 1. Voltmeter - Connect positive lead to A8 and negative lead to B4 of connector from power module. 2. Test point signal monitor - connect as above. Set SYNC for INT +. Set selector switch to position 8: H to 2 msec per division (msec/D). | Should read -28 volts dc when test switch is in OPERATE, 0 volt when in TEST. Should see - 28 to 0 volt transition as switch is moved from OPERATE to TEST. | |

| | | | | |
|---|-----------|--|---|---|
| <p>Failure of motors to start when in automatic condition.</p> <p>Note: Omit Steps 3 and 4 if unattended answering is not included in DATA-SPEED equipment.</p> | <p>10</p> | <p>Check relay driver amplifier. Disconnect interface on data set. VOM or scope can be used.</p> <ol style="list-style-type: none"> 1. Voltmeter - Connect positive lead to A8 and negative lead to B4 of connector from power module. 2. Test point signal monitor - connect as above. Set SYNC for INT +. Set selector switch to position 8: H to 2 msec per division (msec/D). V to 2 volts per division (V/D). | <p>Should read -28 volts dc when test switch is in OPERATE, 0 volt when in TEST.</p> <p>Should see - 28 to 0 volt transition as switch is moved from OPERATE to TEST.</p> | |
| <p>11</p> | <p>11</p> | <p>Check of automatic motor start in conjunction with data set 202A.</p> <ol style="list-style-type: none"> 1. MANUAL - AUTOMATIC switch in AUTOMATIC. 2. Data set in AUTO. 3. TEST - OPERATE in OPERATE and data set interface connected. | <p>Motor should start.</p> | <p>Proceed to Step 12.</p> |
| <p>12</p> | <p>12</p> | <p>Disconnect data set interface and using VOM or scope check interlock output of pin 6 of data set connector. Ground test equipment to pin 1. Using a nearby telephone, call data line number in the normal manner. Answer call and press DATA button. Note output. If scope is used, place controls on INT +, selector switch to Pos. 8: H - 2 msec/D, V - 10V/D.</p> | <p>+8±1 volts for ON. 0±1 volt for OFF.</p> <p>When switching from TALK to DATA, a 0 to 8±1 volt transition should occur.</p> | <p>Check data set and if in trouble, replace.</p> |

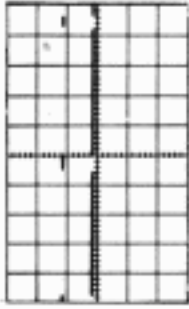
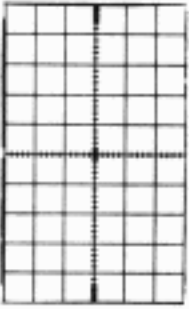
TABLE D

Tape Sender - Trouble Shooting (No Signal Output)

| Symptom | Step | Action | Normal Indication and Procedure | Abnormal Indication and Procedure | Scope Displays and Settings |
|--|------|--|--|---|---|
| Data set 202A failure | 1 | With handset off hook, depress DATA button. | DATA lamp should light and stay lighted. Proceed to Step 2. | Check fuse in data set 202A. Replace if necessary and recheck. Proceed to Step 2. | |
| | 2 | Using a nearby telephone, call data line number in the normal manner. Answer call and press DATA button. | A mark tone of 1200 cps should be heard in receiver of calling telephone. Proceed to Step 3. | Check or replace data set, if necessary, following test instructions in Section 592-013-500. | |
| Data set operating. No modulated signal. | 3 | Check power supply voltages. | All voltages should read nominal voltage ± 10 percent. Proceed to Step 4. | Replace any blown fuses and recheck. Readjust voltage levels per requirements. | |
| | 4 | With reader sending all marks, check signal converter output lead on test point CM6. | See scope display. If correct, check wiring to data set. | Proceed to Step 5. |  <p>Pos-8 TP-CM6 H-2msec/D V-10V/D T-EXT + BM3</p> |
| | 5 | With reader sending all marks, check distributor output at test point CN2. | See scope display. If correct, proceed to Step 6. | Proceed to Step 7. |  <p>Pos-6 TP-CN2 H-2msec/D V-2V/D T-EXT + BM3</p> |
| | 6 | Check signal converter test point CN3. | See scope display. If correct, replace Z212, card CM and recheck Step 5. | If incorrect, replace Z211, card CN and recheck. Inspect wiring between distributor and signal converter. |  <p>Pos-6 TP-CN3 H-2msec/D V-2V/D T-EXT + BM3</p> |
| | 7 | Check start-stop oscillator in distributor at test point BQ2. | If scope display is correct, proceed to Step 8. | Proceed to Step 12. |  <p>Pos-7 TP-BQ2 H-2msec/D V-2V/D T-EXT + BM3</p> |
| | 8 | Check sample delay in distributor at test point BF1. | If scope display is correct, proceed to Step 9. | If incorrect, replace Z105, card BF. Recheck Step 7. |  <p>Pos-4 TP-BF1 H-100usec/D</p> |

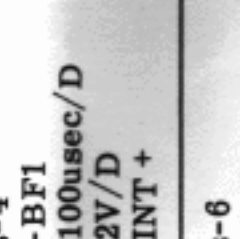
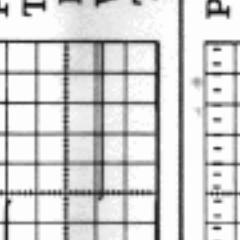
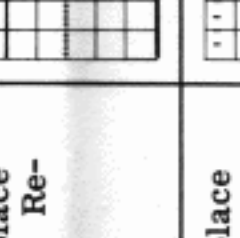
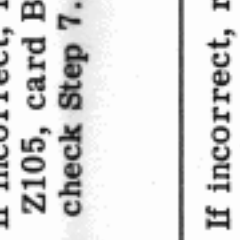
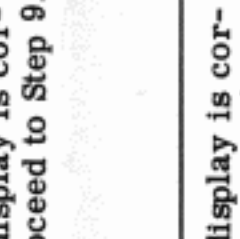
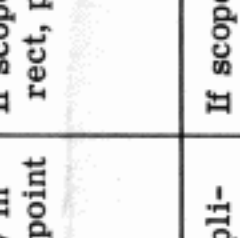
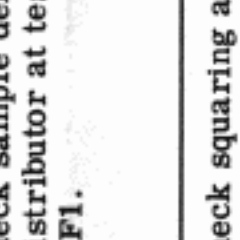
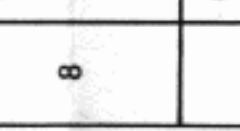
| | | | | | | |
|----|--|--|--|---|---|------------------------------------|
| | | | card CM and recheck Step 5. | recheck. inspect wiring between distributor and signal converter. |  | H-2msec/D V-2V/D T-EXT + BM3 |
| 7 | Check start-stop oscillator in distributor at test point BQ2. | If scope display is correct, proceed to Step 8. | Proceed to Step 12. |  | Pos-7 TP-BQ2 H-2msec/D V-2V/D T-EXT + BM3 | |
| 8 | Check sample delay in distributor at test point BF1. | If scope display is correct, proceed to Step 9. | If incorrect, replace Z105, card BF. Recheck Step 7. |  | Pos-4 TP-BF1 H-100usec/D V-2V/D T-INT + | |
| 9 | Check squaring amplifier in distributor at test point BN2. | If scope display is correct, proceed to Step 10. | If incorrect, replace Z109, card BN and recheck Step 8. |  | Pos-6 TP-BN2 H-2msec/D V-2V/D T-EXT + BE3 | |
| 10 | Check inhibit gate in distributor at test points BG3 and BG4. | If scope display is correct, proceed to Step 11. | If incorrect, replace Z106, card BG and recheck Step 9. |  | Pos-7 TP-BG3 H-2msec/D V-2V/D T-INT + | |
| 11 | Check register elements in distributor at test points CF2, CG2, CH2, CJ2, and CK2. | If scope display is correct, proceed to Step 13. | If incorrect, replace defected card(s). |  | Pos-6 TP-BG4 H-2msec/D V-2V/D T-EXT + BG3 | |
| 12 | Check oscillator control in distributor at test point BM3. | If scope display is correct, replace Z108, card BQ and readjust. | Proceed to Step 13. |  | Pos-6 TP-CF2-CK2 H-2msec/D V-2V/D T-EXT + BF1 | |
| 13 | Check the following in sequence: Inh. gate in distributor at test points BH4 and BH5. Terminal D on card BH. | If scope display at BH4 is correct, replace Z104, card BM and recheck Step 12. | If BH5 is normal and input on terminal D is abnormal, proceed to Step 18. If both are normal, replace Z103, card BH and recheck. If both are present, the trouble may be a timing problem. If signal is present on terminal D and not on BH5, proceed to Step |  | Pos-2 TP-BH4 H-2usec/D V-2V/D T-EXT + BE3 | |
| | | | |  | Pos-2 TP-BH5 H-2usec/D V-2V/D T-EXT + BE3 | |

Electronic failure



| | | | | | |
|--|-----------|---|---|--|---|
| | | | | | <p>Pos-6 TP-BG4 H-2msec/D V-2V/D T-EXT + BG3</p>  |
| | <p>11</p> | <p>Check register elements in distributor at test points CF2, CG2, CH2, CJ2, and CK2.</p> | <p>If scope display is correct, proceed to Step 13.</p> | <p>If incorrect, replace defected card(s).</p> | <p>Pos-6 TP-CF2-CK2 H-2msec/D V-2V/D T-EXT + BF1</p>  |
| | <p>12</p> | <p>Check oscillator control in distributor at test point BM3.</p> | <p>If scope display is correct, replace Z108, card BQ and readjust.</p> | <p>Proceed to Step 13.</p> | <p>Pos-6 TP-BM3 H-2msec/D V-2V/D T-EXT + BD1</p>  |
| | <p>13</p> | <p>Check the following in sequence: Inh. gate in distributor at test points BH4 and BH5. Terminal D on card BH.</p> | <p>If scope display at BH4 is correct, replace Z104, card BM and recheck Step 12.</p> | <p>If BH5 is normal and input on terminal D is abnormal, proceed to Step 18. If both are normal, replace Z103, card BH and recheck. If both are present, the trouble may be a timing problem. If signal is present on terminal D and not on BH5, proceed to Step 14.</p> | <p>Pos-2 TP-BH4 H-2msec/D V-2V/D T-EXT + BE3</p>  <p>Pos-2 TP-BH5 H-2msec/D V-2V/D T-EXT + BE3</p>  <p>Pos-8 TP-BHD H-2msec/D V-10V/D T-EXT + BR2 on signal converter.</p>  |

TABLE D (Continued)

Tape Sender - Trouble Shooting (No Signal Output)

| Symptom | Step | Action | Normal Indication and Procedure | Abnormal Indication and Procedure | Scope Displays and Settings |
|--------------------------------|------|--|---|-----------------------------------|---|
| Electronic failure (continued) | 14 | Check stop timer in distributor at test point BD1. | If scope display is correct, replace Z102, card BE in distributor. | Proceed to Step 15. |  <p>Pos-4 TP-BD1 H-100usec/D V-2V/D T-EXT + BD1</p> |
| | 15 | Check signal delay in distributor at test point BB3. | If scope display is correct, replace Z101, card BD in distributor, and adjust. | Proceed to Step 16. |  <p>Pos-6 TP-BB3 H-2msec/D V-2V/D T-INT +</p> |
| | 16 | Check pickup amplifier in converter at test point CPJ. | If scope display is correct, replace Z121, card BB in distributor. | Proceed to Step 17. |  <p>Pos-6 TP-CPJ H-2msec/D V-2V/D T-INT +</p> |
| | 17 | Check pickup in converter at test point CPA. | If scope display is correct, replace Z209, card CP in converter and recheck Step 16. Check wiring with power off, check dc resistance between -6 volts and terminal A. Should be 800 to 900 ohms. | Proceed to Step 18. |  <p>Pos-8 TP-CPA H-2msec/D V-10V/D T-INT -</p> |
| | 18 | Check universal contact in converter at test point CR4. | If scope display is correct, check wiring between distributor and converter. | Proceed to Step 19. |  <p>Pos-8 TP-CR4 H-2msec/D V-10V/D T-EXT + BR2</p> |
| | 19 | Check universal contacts in converter at test point CRE. | If abnormal signal, check and adjust contacts. If no signal, check wiring to tape reader. | |  <p>Pos-8 TP-CRE H-2msec/D V-10V/D T-EXT + BR2</p> |

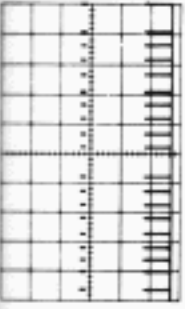
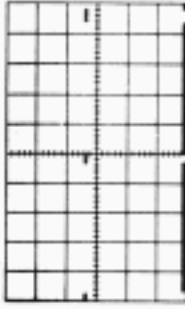
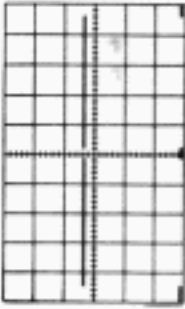
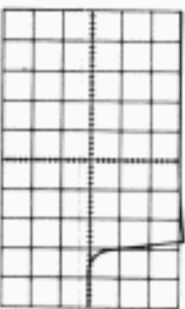
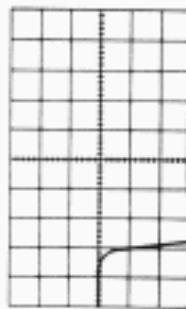
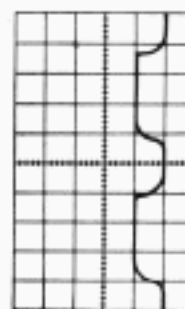
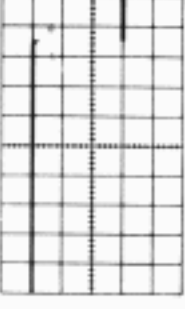
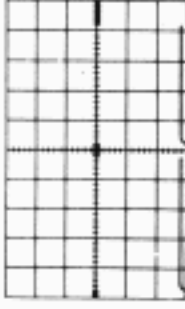
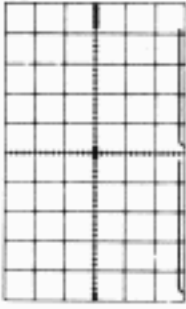
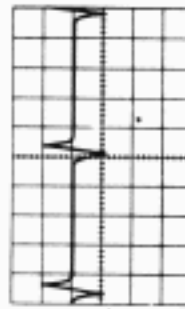
| | |
|--|--|
| | |
| | |
| | |
| | |
| | |
| | |
| | |
| | |
| | |
| | |

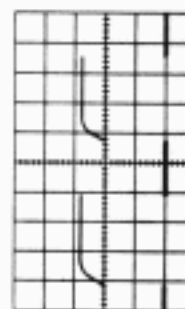
TABLE E
Tape Sender-Trouble Shooting (Level Failure)

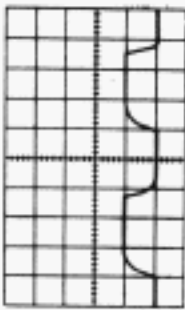
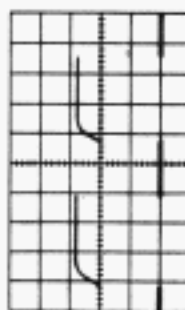
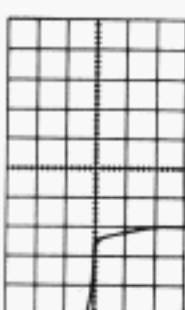
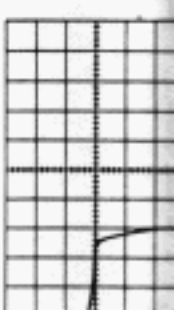
| Symptom | Step | Action | Normal Indication and Procedure | Abnormal Indication and Procedure | Scope Displays and Settings |
|------------------------------|------|--|--|---|--|
| Reader contact failure * | 1 | With reader sending all marks, check integrators in converter test points CQ1 to 5 or CR1 to 3, whichever level is failing. CQ1 to CQ5 are levels 0 to 4, CR1 to CR3 are levels 5 to 7. | If scope display is correct, proceed to Step 3. | If incorrect, proceed to Step 2. |  <p>Pos-8 TP-CQ1-5, CR1-3 H-2msec/D V-10V/D T-EXT + BR2</p> |
| | 2 | Interchange Z201, card CQ and Z202, card CR. Recheck | If level failure moves to corresponding level of interchanged card, replace that card and recheck Steps 1 and 2. | If trouble is same level, check input terminal to respective cards. See scope display. Make mechanical adjustments to reader if necessary. If there is no signal input, visually check reader contact sensing pins, etc., and wiring from tape reader to converter. |  <p>Pos-8 TP-CQA-E, CRB-D H-2msec/D V-10V/D T-EXT + BR2</p> |
| Electronic circuit failure * | 3 | With reader sending all marks, check respective card in which level failure occurs. Test Points Level Z203 BR3, 4 0, 1 Z204 BQ3, 4 2, 3 Z205 BP3, 4 4, 5 Z206 BN3, 4 6, 7 | See scope display. If correct, proceed to Step 4. | Interchange card that is failing with working card and recheck. Replace defective card |  <p>Pos-2 TP-† H-2msec/D V-2V/D T-INT + † Test points are shown in action column.</p> |
| | 4 | Check output of respective level or levels that are failing in converter. Test Point Level BS1 0 BS2 1 BS4 2 | See scope display. Proceed to Step 5. | Interchange cards Z207 and Z208 and recheck. Replace defective card. |  <p>Pos-2 TP-† H-2msec/D V-2V/D T-INT + † Test points are shown in action</p> |

| | | | | | |
|-------------------------------------|----------|--|---|---|---|
| <p>Electronic circuit failure *</p> | <p>4</p> | <p>Proceed to Step 5.</p> | <p>Procede to Step 5.</p> | <p>and Z208 and recheck. Replace defective card.</p> | <p>Interchange cards Z201 and Z208 and recheck. Replace defective card.</p> |
| <p>Electronic circuit failure *</p> | <p>5</p> | <p>If level failure moves to corresponding level of interchanged card, replace that card and recheck Step 4.</p> | <p>See scope display. If same level fails, check wiring between distributor and converter. Check for loose connections in modules. If interchanged level fails, replace defective card.</p> | <p>Interchange cards Z201 and Z208 and recheck. Replace defective card.</p> | <p>Interchange cards Z201 and Z208 and recheck. Replace defective card.</p> |

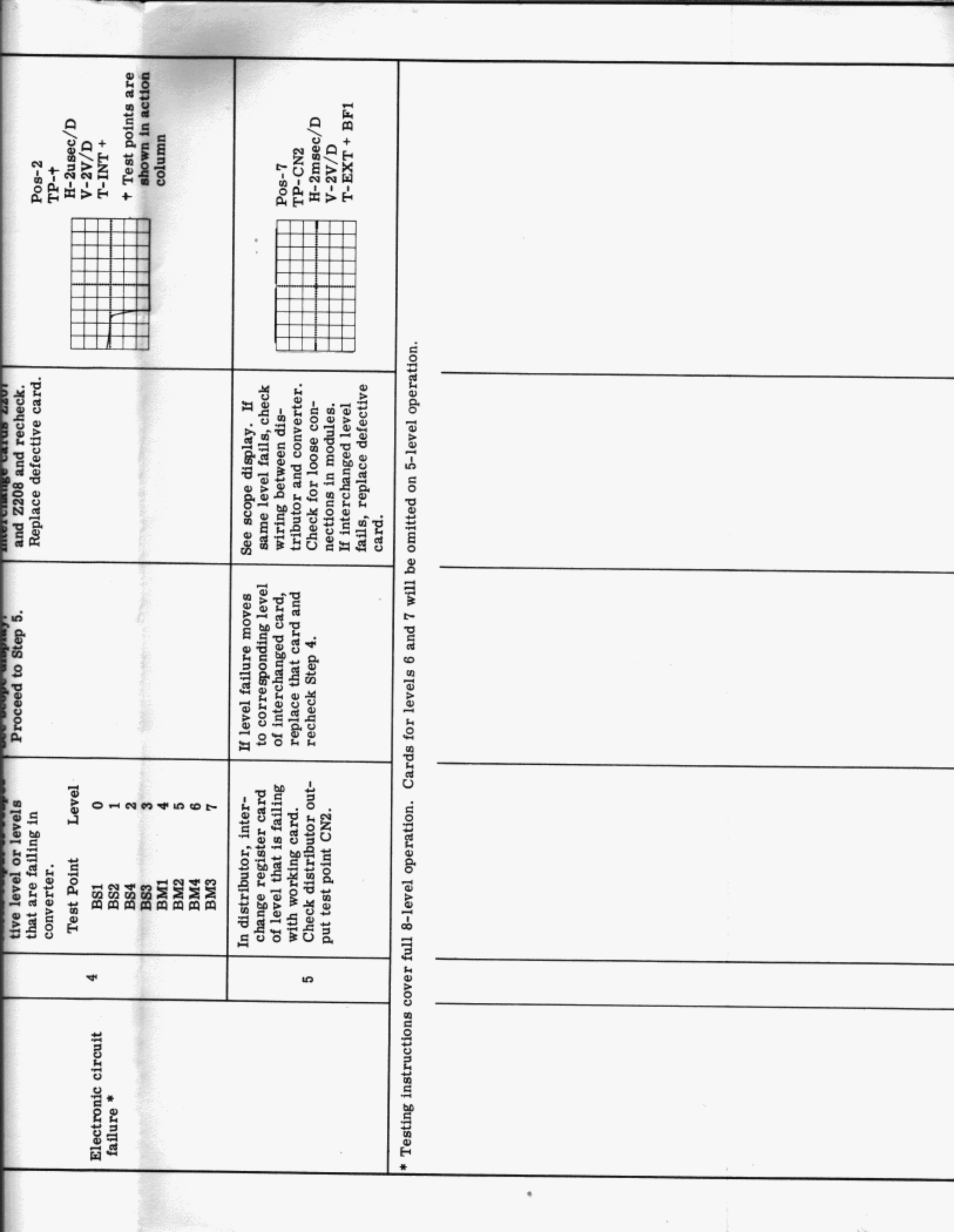



+ Test points are shown in action column
 H-2usec/D
 V-2V/D
 T-INT +
 Pos-2
 TP-+



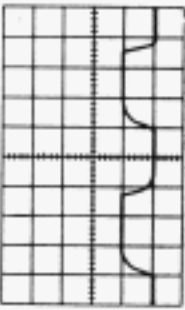
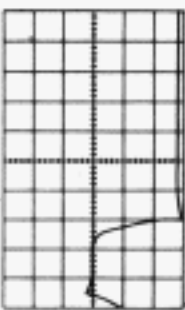
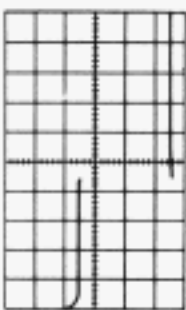
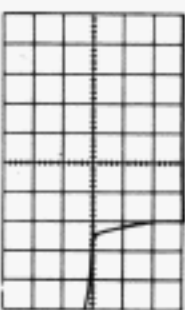
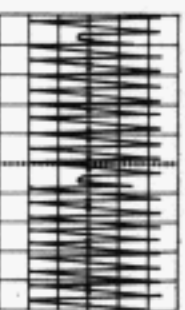

H-2msec/D
 V-2V/D
 T-EXT + BF1
 Pos-7
 TP-CN2

* Testing instructions cover full 8-level operation. Cards for levels 6 and 7 will be omitted on 5-level operation.

TABLE F

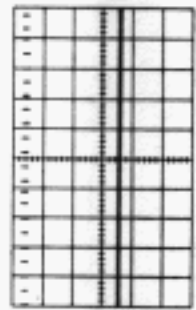
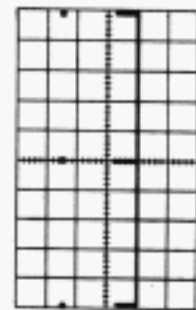
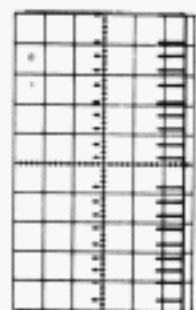
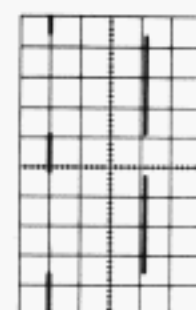
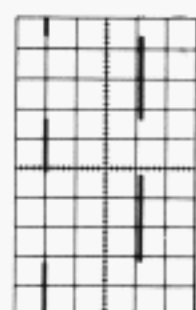
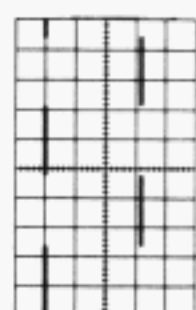
Tape Sender-Trouble Shooting (Garbled Message)

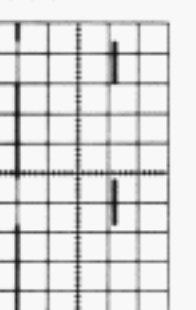
| Symptom | Step | Action | Normal Indication and Procedure | Abnormal Indication and Procedure | Scope Displays and Settings |
|---------------------|------|--|---|---|--|
| Tape reader failure | 1 | With start-stop lever in RUN, check tape reader operating magnet and tape feed mechanism for proper operation. | If correct, proceed to Step 2. | Check reader operating magnet circuit, tape out contacts, tight tape contact, and wiring. If necessary, readjust. | |
| | 2 | With reader sending all marks, check all reader mark contacts at converter. Test Points Levels CR1 to CR3 5 to 7 CQ1 to CQ5 0 to 4 CR4 is universal contact. | See scope display. If correct, proceed to Step 3. | If incorrect, check respective circuit card input Z201, card CQ and Z202, card CR. Check wiring. Check reader contacts for dirt, oil, etc., and if necessary readjust contacts. |  <p>Pos-8 TP-* H-2msec/D V-10V/D T-EXT + BR2 * Test points are shown in action column.</p> |
| | 3 | Check sample lead in distributor at test point BH2. | See scope display. If correct, proceed to Step 6. | If incorrect, proceed to Step 4. |  <p>Pos-2 TP-BH2 H-2usec/D V-2V/D T-INT +</p> |
| | 4 | Check sample delay in distributor at test point BF1. | See scope display. If correct, proceed to Step 5. | If incorrect, replace Z105, card BF in distributor, adjust and recheck Step 3. |  <p>Pos-4 TP-BF1 H-100usec/D V-2V/D T-INT +</p> |
| | 5 | Check "SET 1" amplifier in distributor at test point BE4. | See scope display. If correct, proceed to Step 6. | If incorrect, replace Z102, card BE and recheck Step 4. |  <p>Pos-2 TP-BE4 H-2usec/D V-2V/D T-INT +</p> |
| | 6 | Check start-stop oscillator in distributor at test point BQ2. | See scope display. If correct, proceed to Step 7. | If incorrect, replace Z108, card BQ and make adjustments if necessary. |  <p>Pos-7 TP-BQ2 H-2msec/D V-2V/D T-EXT + BM3</p> |
| | 7 | Check squaring amplifier in distributor at test point BN2. | See scope display. If correct, proceed to Step 8. | If incorrect, replace Z109, card BN and recheck. |  <p>Pos-6 TP-BN2 H-2msec/D</p> |

| | | | |
|---|---|--|--|
| | necessary. | | V-2V/D T-EXT + BM3 |
| 7 | Check squaring amplifier in distributor at test point BN2. | See scope display. If correct, proceed to Step 8. | <p>If incorrect, replace Z109, card BN and recheck.</p>  <p>Pos-6 TP-BN2 H-2msec/D V-2V/D T-EXT + BE3</p> |
| 8 | Check inhibit gate in distributor at test points BG3 and BG4. | See scope displays. If correct, proceed to Step 9. | <p>If incorrect, replace Z106, card BG and recheck.</p>  <p>Pos-6 TP-BG3 H-2msec/D V-2V/D T-INT +</p>  <p>Pos-6 TP-BG-4 H-2msec/D V-2V/D T-EXT + BG3</p> |
| 9 | Check intermittent operation of signal register cards with reader sending all spaces (blanks). With scope trigger on EXT+ at test point BF1, test cards CF2 to CL2. | See scope display. | <p>Replace defective card and recheck.</p>  <p>Pos-6 TP-CF2 H-2msec/D:V-2V/D T-EXT + BF1</p>  <p>Pos-6 TP-CG2 H-2msec/D:V-2V/D T-EXT + BF1</p>  <p>Pos-6 TP-CH2 H-2msec/D:V-2V/D T-EXT + BF1</p>  <p>Pos-6 TP-CJ2 H-2msec/D:V-2V/D T-EXT + BF1</p>  <p>Pos-6 TP-CK2 H-2msec/D:V-2V/D T-EXT + BF1</p>  <p>Pos-6 TP-CL2 H-2msec/D:V-2V/D T-EXT + BF1</p> |

Electronic circuit failure

Check intermittent operation of signal register cards with reader sending all spaces (blanks). With scope trigger on EXT+ at test point BF1, test cards CF2 to CL2.

See scope display.

Replace defective card and recheck.

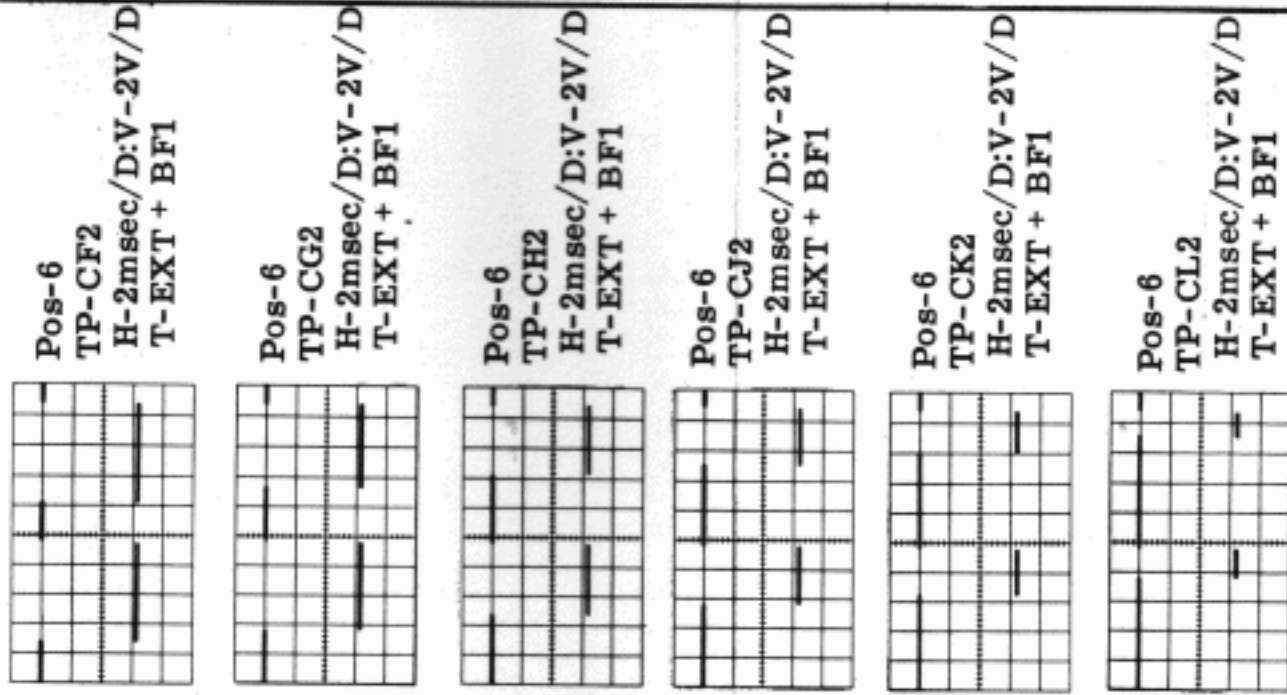

TABLE G

Tape Receiver-Trouble Shooting (Complete Failure)



| Symptom | Step | Action | Normal Indication and Procedure | Abnormal Indication and Procedure |
|---------------|------|--|--|--|
| Power failure | 1 | Check POWER lamp on control panel (yellow). | Should be on. Proceed to 2. | Proceed to Step 2 or check modular power supply. Should be on. Check -28 volt dc supply. |
| | 2 | Check whether reperfector or winder motors will operate. | Proceed to Step 3. | Proceed to Step 3. Check reset button on motor. |
| | 3 | With receiver off hook, place data set in data mode. | DATA lamp should light. | Check line fuse in cabinet. Replace if necessary with fuse rated the same. Proceed to Step 4. Check fuse in data set 202A. |
| | 4 | If Steps 1, 2, and 3 fail, check the following: Check for loose power connections. | All plugs should be in place. Proceed to Step 5. | Place plugs in proper receptacles and recheck per Steps 1 through 3. |
| | 5 | With power removed, check for loose or broken wires and possible short circuits using VOM. Refer to drawing. | Proceed to Step 6. | Correct and recheck per Steps 1 through 3. |
| | 6 | Check power input to cabinet. | 117-volt 60-cycle ac power should be supplied to the cabinet. The data set, modular power supply and motors should operate when their respective switches are closed. Proceed to Step 7. | If power is not available, refer this to the customer. |
| | 7 | Visual check of modular power supply. Check all voltages by switching voltage indicator | Proceed to Step 8. | Zero reading indicates blown fuses. If -6 volt fuse is blown, this may indicate -8 volt on the |

| | | | | | |
|--|--|--|--|---|--|
| | | | | | |
| switches are closed. Proceed to Step 7. | Proceed to Step 8. | Zero reading indicates blown fuses. If -6 volt fuse is blown, this may indicate -8 volt on the meter. Replace blown fuses and proceed to Step 8. | Indicate circuit card or data set failure. Check supply voltages. Proceed to Step 9. | Proceed to Step 10. | |
| Visual check of modular power supply. Check all voltages by switching voltage indicator located on the power supply and reading respective voltage on the meter. | Proceed to Step 8. | When DATA button is depressed, the motor start relay should operate. With power off, check wiring for loose connection to motors. | Trouble has been found. | VOM should read $+8 \pm 1$ volts when DATA button is depressed. 1. Check wiring from data set to automatic answer kit. 2. Check wiring to automatic answer kit. | |
| 7 | Visual check of motor start relay on automatic answer kit. Place call to terminal using nearby telephone. Answer call and depress DATA button. | Replace circuit card on automatic answer kit and repeat Step 8. | 10 | Disconnect interface on data set. Using VOM, ground instrument (1) on pin 1 of data set receptacle and place other probe on pin 6. Repeat Step 8. | |
| Tape punch and winder motors do not start when in automatic answer (when provided). | | | | | |

| | |
|--|--|
| | |
| <p>Data set failure. Re-place data set 202A.</p> | |
| <p>VOM should read $+8 \pm 1$ volts when DATA button is depressed.</p> <ol style="list-style-type: none"> 1. Check wiring from data set to automatic answer kit. 2. Check wiring to automatic answer kit. | |
| <p>and repeat Step 8.</p> <p>Disconnect interface on data set. Using VOM, ground instrument (1) on pin 1 of data set receptacle and place other probe on pin 6. Repeat Step 8.</p> | |
| <p>10</p> | |
| <p>Tape punch and winder motors do not start when in automatic answer (when provided).</p> | |

TABLE H

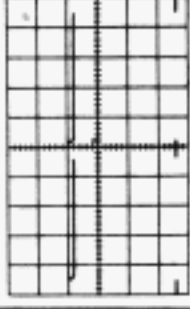
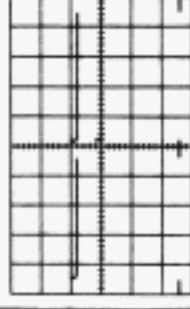
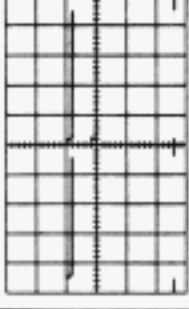
Tape Receiver-Trouble Shooting (Not Punching Tape)

| Symptom | Step | Action | Normal Indication and Procedure | Abnormal Indication and Procedure | Scope Displays and Settings |
|---|------|---|---|--|--|
| Data set 202A failure or electronic failure | 1 | Tape punch motor on. Depress LTRS FO button. | Tape punch should feed out letters tape. Proceed to Step 2. | Proceed to Step 13. | |
| | 2 | Place test switch located in TRD module in TEST position. | Tape punch should feed out blank tape. Check the following in sequence: 1. Check data set and replace if necessary. 2. Check wiring for loose connection between data set and signal converter. | Proceed to Step 3. | |
| | 3 | To check electronics use test point signal monitor or general purpose oscilloscope. Place test switch in OPERATE position. Place call to test center to obtain test all-marking signal. In signal converter check test point CF3. | If scope display is correct, this wave form represents an all-marking signal. Proceed to Step 4. | Replace card Z401 and recheck. Check terminal CFB. Check wiring between data set and signal converter. |  <p>Pos-6 TP-CF3 H-2msec/D V-2V/D T-INT -</p> |
| | 4 | Check signal gate test point CP1 in distributor. | If scope display is correct, proceed to Step 19. Subsequent test can be made with TEST-OPERATE switch (in distributor module) in Test position for off-line electronic check receiving blanks. | Check terminal CPC of card Z301. Also check BS2. If displays are correct, replace Z301 and recheck. If signal on CPC is abnormal, check wiring between distributor and converter with power OFF. If signal on BS2 is abnormal, replace Z324 and recheck. If still abnormal, proceed to Step 5. |  <p>Pos-6 TP-CP1 H-2msec/D V-2V/D T-INT -</p>  <p>Pos-6 TP-CPC H-2msec/D V-2V/D T-INT -</p>  <p>TYPE 1 Pos-6 TP-BS2</p> |

Electronic failure

| | | | |
|----------|---|---|--|
| <p>4</p> | <p>receiving blanks.</p> | <p>verter with power OFF. If signal on BS2 is abnormal, replace Z324 and recheck. If still abnormal, proceed to Step 5.</p> | |
| <p>5</p> | <p>Test can be made off-line with distributor switch in TEST position. Check register drive emitter follower test point CL5 in distributor.</p> | <p>See scope display. This represents signal when blanks are being re-generated. Note: Scope display shown is for TYPE 2. TYPE 1 display is similar, except stop time is 2 bits longer.</p> | |
| <p>6</p> | <p>In distributor, check register drive, test point BR3.</p> | <p>See scope display. If correct, proceed to Step 7. Note: Scope display shown is for TYPE 2. TYPE 1 display is similar except stop time is 2 bits longer.</p> | |
| <p>7</p> | <p>In distributor, check register drive, test point BR4.</p> | <p>See scope display. If correct, proceed to Step 8.</p> | |
| <p>8</p> | <p>In distributor, check start delay, test point CM1.</p> | <p>See scope display. If correct, proceed to Step 11. Note: This is an adjustment.</p> | |





| | | |
|---|---|---|
| <p>5</p> <p>drive emitter follower test point CL5 in distributor.</p> | <p>Note: Scope display shown is for TYPE 2. TYPE 1 display is similar, except stop time is 2 bits longer.</p> | <p>T-INT +</p>  |
| <p>6</p> <p>In distributor, check register drive, test point BR3.</p> | <p>If incorrect, replace Z303, card BR, and recheck.</p> | <p>Pos-6 TP-BR3 H-2msec/D V-2V/D T-INT -</p>  |
| <p>7</p> <p>In distributor, check register drive, test point BR4.</p> | <p>If incorrect, replace Z303 card BR and recheck.</p> | <p>Pos-6 TP-BR4 H-2msec/D V-2V/D T-INT +</p>  |
| <p>8</p> <p>In distributor, check start delay, test point CM1.</p> | <p>If incorrect, proceed to Step 9.</p> | <p>Pos-4 TP-CM1 H-100usec/D V-2V/D T-EXT + BR3</p>  |

TABLE H (Continued)

Tape Receiver-Trouble Shooting (Not Punching Tape)

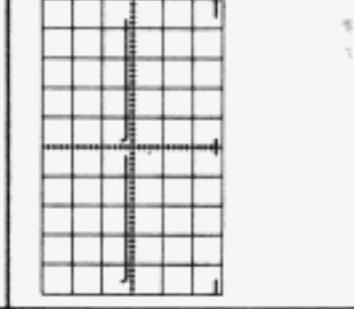
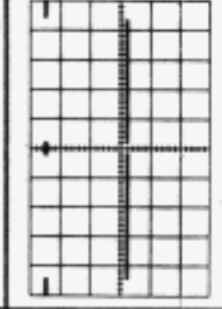
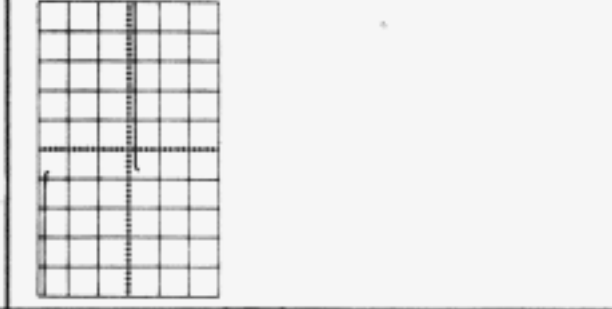
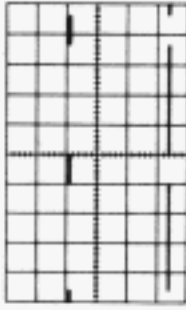
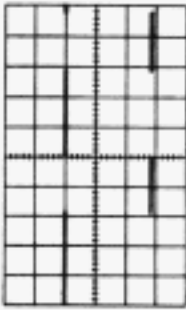
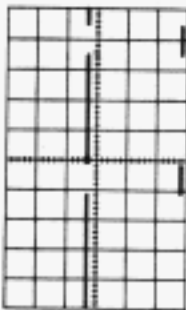
| Symptom | Step | Action | Normal Indication and Procedure | Abnormal Indication and Procedure | Scope Displays and Settings |
|------------------------------|------|--|--|---|---|
| Electronic failure continued | 9 | Check terminal CMJ in distributor. | See scope display. If correct, replace Z305, card CM adjust and recheck. | If incorrect, proceed to Step 10. |  <p>TYPE 2 Pos-6 TP-CMJ H-2msec/D V-2V/D T-EXT + BR3</p> |
| | | | | |  <p>TYPE 1 Pos-6 TP-CMJ H-2msec/D V-2V/D T-EXT + BR3</p> |
| | 10 | Check control register in distributor, test point BG3. | See scope display. If correct, check wiring. | Replace Z310, card BG and recheck. Note: Control register primes START AND gate so that start pulse goes to "set 1" control register which subsequently starts the oscillator. |  <p>TYPE 2 Pos-6 TP-BG3 H-2msec/D V-2V/D T-EXT + BR3</p> |
| | | | | |  <p>TYPE 1 Pos-6 TP-BG3 H-2msec/D V-2V/D T-EXT + BR3</p> |
| | 11 | While receiving all marks, check signal delay in distributor at test point CJ3. | See scope display. If correct, proceed to Step 12. | If incorrect, replace Z304, card CJ. Note: Control register primes START AND gate so that start pulse goes to "set 1" control register which subsequently starts the oscillator. |  <p>Pos-6 TP-CJ3 H-2msec/D V-2V/D T-EXT + BR3</p> |
| | | | | |  <p>Pos-6 TP-CP4 H-2msec/D V-2V/D T-EXT + BR3</p> |
| | 12 | While receiving all marks, check START OR gate in distributor at test point CP4. | See scope display. If correct, proceed to Step 13. | Replace Z301, card CP and recheck. |  <p>Pos-6 TP-CP4 H-2msec/D V-2V/D T-EXT + BR3</p> |

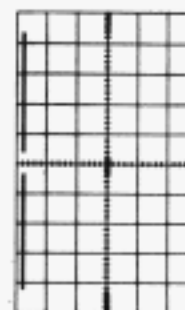

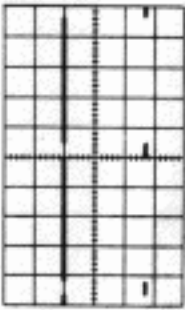
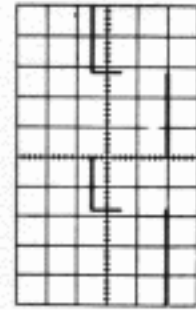
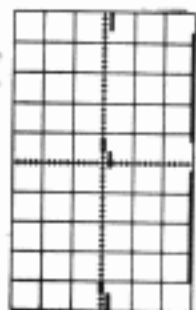
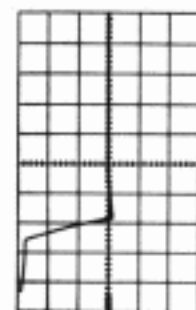
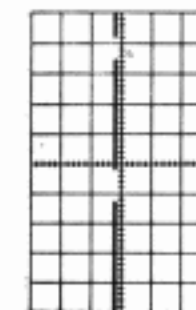
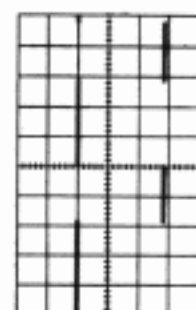
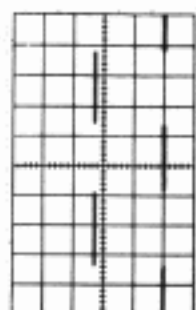
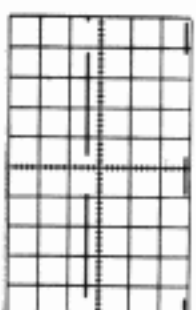
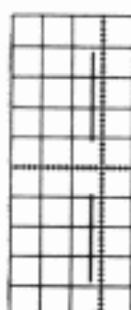
| | | | |
|----|--|--|---|
| | oscillator. | | |
| 12 | While receiving all marks, check START OR gate in distributor at test point CP4. | See scope display. If correct, proceed to Step 13. | <p>Replace Z301, card CP and recheck.</p>  <p>Pos-6 TP-CP4 H-2msec/D V-2V/D T-EXT + BR3</p> |
| 13 | Check START AND gate in distributor at test point CP2. | See scope display. If correct, proceed to Step 4. Note: Stop time 2 bits longer for TYPE 1. | <p>Replace Z301, card CP and recheck.</p>  <p>TYPE 1 Pos-6 TP-CP2 H-2msec/D V-2V/D T-EXT + BR3</p>  <p>TYPE 2 Pos-6 TP-CP2 H-2msec/D V-2V/D T-EXT + BR3</p> |
| 14 | Check start pulse amplifier in distributor at test point CL3. | See scope display. If correct, proceed to Step 15. | <p>Replace Z302, card CL and recheck.</p>  <p>Pos-2 TP-CL3 H-2msec/D V-2V/D T-INT +</p> |
| 15 | Check control register in distributor at test points BG2 and BG3. | See scope display, BG2 is inverse of BG3. If correct, proceed to Step 16. | <p>Replace Z310, card BG and recheck.</p>  <p>TYPE 2 Pos-6 TP-BG3 H-2msec/D V-2V/D T-EXT + BR3</p>  <p>TYPE 1 Pos-6 TP-BG3 H-2msec/D V-2V/D T-EXT + BR3</p> |
| 16 | With module OPERATE-TEST switch in TEST position, check signal register. For type 2 units, begin check at element BQ2. For type 1 units, begin check at element BN2. Waveforms should correspond as signal is shifted down register. | See scope display. If correct, proceed to Step 17. | <p>Check all register cards.</p> <p>Note: Only 3 waveforms are shown. Remainder should be similar except for increasing space time.</p> <p>Waveforms applicable for Type 1 and Type 2 equipment.</p>  <p>Pos-6 TP-BM2 H-2msec/D V-2V/D T-EXT + CMI</p>  <p>Pos-6 TP-BP2 H-2msec/D V-2V/D T-EXT + CMI</p>  <p>Pos-6 TP-BN2 H-2msec/D V-2V/D T-EXT + CMI</p> |

Electronic failure of control register or start-stop oscillator

| | | | | | |
|--|---|--|--|---|--|
| <p>Electronic failure of control register or start-stop oscillator</p> | <p>14</p> | <p>Check start pulse amplifier in distributor at test point CL3.</p> | <p>See scope display. If correct, proceed to Step 15.</p> | <p>Replace Z302, card CL and recheck.</p> | |
| <p>15</p> | <p>Check control register in distributor at test points BG2 and BG3.</p> | <p>See scope display, BG2 is inverse of BG3. If correct, proceed to Step 16.</p> | <p>Replace Z310, card BG and recheck.</p> | | |
| <p>16</p> | <p>With module OPERATE-TEST switch in TEST position, check signal register. For type 2 units, begin check at element BQ2. For type 1 units, begin check at element BN2. Waveforms should correspond as signal is shifted down register.</p> | <p>See scope display. If correct, proceed to Step 17.</p> | <p>Check all register cards. Note: Only 3 waveforms are shown. Remainder should be similar except for increasing space time. Waveforms applicable for Type 1 and Type 2 equipment.</p> | | |

TABLE H (Continued)

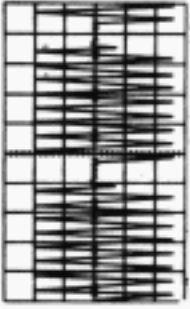
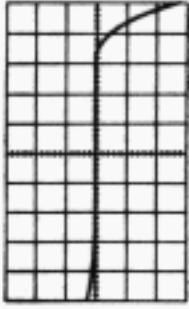
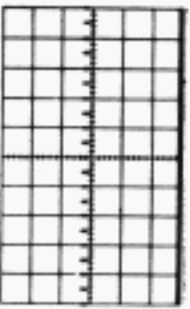
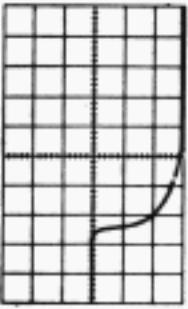
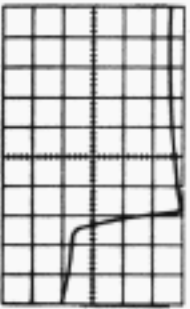
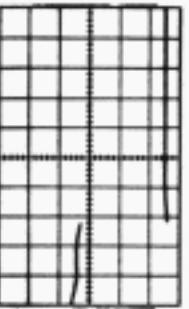
Tape Receiver - Trouble Shooting (Not Punching Tape)

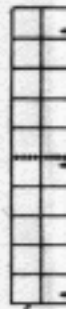
| Symptom | Step | Action | Normal Indication and Procedure | Abnormal Indication and Procedure | Scope Displays and Setting |
|---|------|--|--|--|---|
| Electronic failure of control register or start-stop oscillator continued | 17 | Check start-stop oscillator in distributor at test point CH2. | See scope display. If correct, proceed to Step 18. Type 2 shown. For Type 1 subtract 3 cycles from each burst. | Replace Z311, card CH and recheck. |  <p>Pos-7 TP-CH2 H-2msec/D V-2V/D T-EXT + CL3</p> |
| | 18 | Check squaring amplifier in distributor at test point CF2. | See scope display. If correct, proceed to Step 19. | Replace Z312, card CF and recheck. |  <p>Pos-2 TP-CF2 H-2msec/D V-2V/D T-EXT + CF2</p>  <p>Pos-6 TP-CF2 H-2msec/D V-2V/D T-EXT + CF2</p> |
| Failure of "set 1" delay or transfer prime circuit | 19 | Check "set 1" delay emitter follower in distributor at test point BC5. | See scope display. If correct, proceed to Step 22. | If incorrect, proceed to Step 20. |  <p>Pos-2 TP-BC5 H-2msec/D V-2V/D T-EXT + BD4</p> |
| | 20 | Check "set 1" delay pulse amplifier in distributor at test point BD4. | See scope display. If correct, replace Z309, card BC. | If incorrect, proceed to Step 21. |  <p>Pos-2 TP-BD4 H-2msec/D V-2V/D T-EXT + BD4</p> |
| | 21 | Check "set 1" delay in distributor at test point BE1. | See scope display. If correct, replace Z308, card BD. Time-out not less than 200msec. | If incorrect, replace Z306, card BE and recheck. Proceed to Step 22. |  <p>Pos-4 TP-BE1 H-100msec/D V-2V/D T-INT +</p> |
| | 22 | With tape punch motor on, check transfer prime in converter at test point BJ3. | See scope display. If correct, proceed to Step 23. Positive transition moves across scope. | Replace Z403, card BJ and recheck. Check wiring between distributor and converter using VOM. |  <p>Pos-6 TP-BJ3 H-2msec/D V-2V/D T-EXT + BGC</p> |
| | | With tape punch motor on, check nick- | See scope display. If correct, proceed to | Remove power and, using VOM, check con- |  <p>Pos-8 TP-CDA</p> |

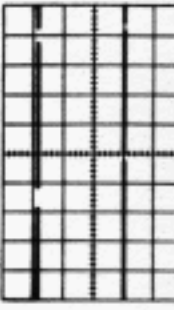
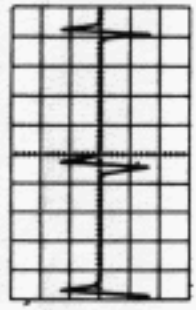
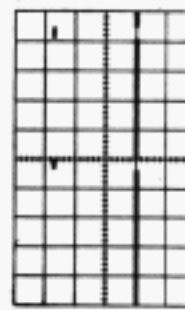
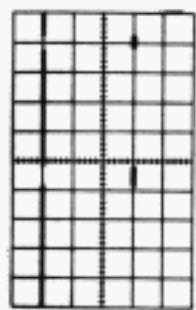
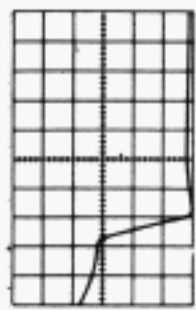
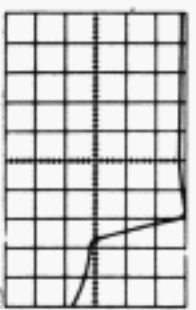
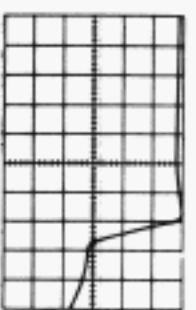
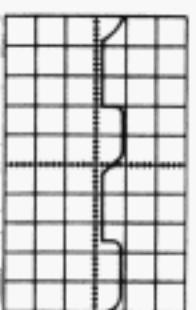
| | | | |
|--|--|--|---|
| | | T-INT + | |
| <p>Pos-6 TP-BJ3 H-2msec/D V-2V/D T-EXT + BGC</p>  | <p>Replace Z403, card BJ and recheck. Check wiring between distributor and converter using VOM.</p> | <p>See scope display. If correct, proceed to Step 23. Positive transition moves across scope.</p> | <p>With tape punch motor on, check transfer prime in converter at test point BJ3.</p> |
| <p>Pos-8 TP-CDA H-2msec/D V-10V/D T-INT -</p>  | <p>Remove power and, using VOM, check continuity between -6 volts and terminal A. Should be between 800 to 900 ohms. This is reading the magnetic pickup coil.</p> | <p>See scope display. If correct, proceed to Step 24.</p> | <p>With tape punch motor on, check pickup signal terminal of converter at CDA.</p> |
| <p>Pos-6 TP-CDJ H-2msec/D V-2V/D T-INT +</p>  | <p>Replace Z404, card CD and recheck.</p> | <p>See scope display. If correct, proceed to Step 25.</p> | <p>With tape punch motor on, check terminal CDJ in converter.</p> |
| <p>Pos-6 TP-BG2 H-2msec/D V-2V/D T-INT -</p>  | <p>Replace Z406, card BG and recheck.</p> | <p>See scope display. If correct, proceed to Step 26. Positive transition moves from right to left across scope.</p> | <p>Check variable pulse delay in converter at test point BG2.</p> |
| <p>Pos-2 TP-BF3 H-2usec/D V-2V/D T-INT +</p>  | <p>Replace Z408, card BF and recheck.</p> | <p>See scope display. If correct, proceed to Step 27.</p> | <p>Check transfer in converter at test point BF3.</p> |
| <p>Pos-2 TP-CG4 H-2usec/D V-2V/D T-EXT + BF3</p>  | <p>Replace Z402, card CG and recheck.</p> | <p>See scope display. If correct, proceed to Step 28.</p> | <p>Check inhibit gate in converter at test point CG4.</p> |
| <p>Pos-2 TP-CH2 H-2usec/D V-2V/D T-EXT + BF3</p>  | <p>Replace Z409, card CH and recheck.</p> | <p>See scope display. If correct, proceed to Step 29.</p> | <p>Check transfer in converter at test point CH2.</p> |
| <p>Pos-6 TP-CJ4 H-2msec/D V-2V/D T-EXT + BF3</p>  | <p>If incorrect, check other magnet pulser cards CK, CL etc. With power off, check wiring between converter and tape punch. Check for the -28 volt dc supply to the magnets.</p> | <p>See scope display.</p> | <p>In converter check magnet pulser output terminal CJ4.</p> |

Failure of transfer circuitry

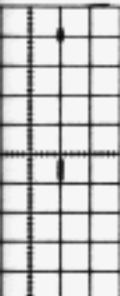
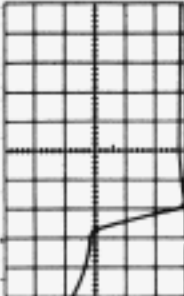
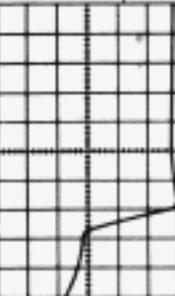
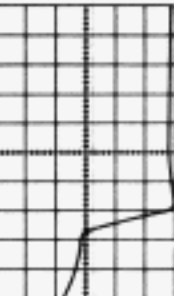
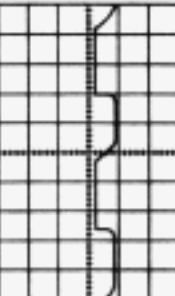
| | | | | |
|----|---|---|---|---|
| 25 | delay in converter at test point BG2. | correct, proceed to Step 26. Positive transition moves from right to left across scope. | and recheck. |  <p>TP-BG2 H-2msec/D V-2V/D T-INT -</p> |
| 26 | Check transfer in converter at test point BF3. | See scope display. If correct, proceed to Step 27. | Replace Z408, card BF and recheck. |  <p>Pos-2 TP-BF3 H-2msec/D V-2V/D T-INT +</p> |
| 27 | Check inhibit gate in converter at test point CG4. | See scope display. If correct, proceed to Step 28. | Replace Z402, card CG and recheck. |  <p>Pos-2 TP-CG4 H-2msec/D V-2V/D T-EXT + BF3</p> |
| 28 | Check transfer in converter at test point CH2. | See scope display. If correct, proceed to Step 29. | Replace Z409, card CH and recheck. |  <p>Pos-2 TP-CH2 H-2msec/D V-2V/D T-EXT + BF3</p> |
| 29 | In converter check magnet pulser output terminal CJ4. | See scope display. | If incorrect, check other magnet pulser cards CK, CL etc. With power off, check wiring between converter and tape punch. Check for the -28 volt dc supply to the magnets. |  <p>Pos-6 TP-CJ4 H-2msec/D V-2V/D T-EXT + BF3</p> |

Failure of transfer circuitry

TABLE J

Tape Receiver - Trouble Shooting (Garbled Message)

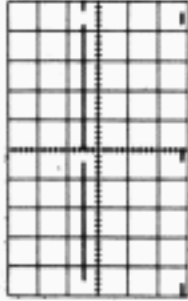
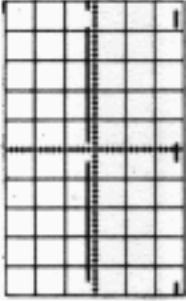
| Symptom | Step | Action | Normal Indication and Procedure | Abnormal Indication and Procedure | Scope Displays and Setting |
|-------------------------------------|------|--|--|--|--|
| Punch or transfer circuitry failure | 1 | Check tape punch, with motors running, depress LTRS FO button. | Punched tape should contain all marks. This will indicate that the tape punch and transfer circuitry are operating. Proceed to Step 2. | Check for loose connections between tape punch and converter. Check output of power module. Proceed to Step 7. | |
| | 2 | Check receiving electronics by placing TEST switch located in distributor module to test position. | Tape punch should feed out blank tape with TEST switch in test position. This will indicate that distributor signal register and shift circuitry are working. Trouble may be in signal from data set or intermittent circuit failure. | Proceed to Step 3. | |
| | 3 | Check input signal to converter at test point CFB with TEST switch in test position. | Under test condition a steady -6 volt signal will be present (space or open line condition). With switch in OPERATE position, reading will be 0 volt when all marks are received through data set. Check data set per Section 592-013-500. If operating properly, proceed to Step 4. | Replace Z401, card CF and recheck. | |
| | 4 | Check signal gate in distributor at test point CP1. | Note: Wave form shown indicates receiving all marks. | Replace Z301, card CP |  <p>Pos-6 TP-CP1 H-2msec/D V-2V/D T-EXT - CNI</p> |
| | 5 | Check signal gate emitter follower in distributor at test point CL5. | See scope display. If correct, proceed to Step 6. | Replace Z302, card CL and recheck. |  <p>Pos-6 TP-CL5 H-2msec/D V-2V/D T-EXT - CNI</p> |

| | | | | |
|--|---|---|---|-----------|
| | <p>V-2V/D T-EXT - CNI</p> | | | |
| | <p>Pos-6 TP-CL5 H-2msec/D V-2V/D T-EXT - CNI</p> | <p>Replace Z302, card CL and recheck.</p> | <p>Check signal gate emitter follower in distributor at test point CL5.</p> | <p>5</p> |
| | <p>Pos-6 TP-BR3 H-2msec/D V-2V/D T-EXT - CNI</p> | <p>Replace Z303, card BR and recheck.</p> | <p>Check register drive in distributor at test point BR3.</p> | <p>6</p> |
| | <p>Pos-6 TP-BR4 H-2msec/D V-2V/D T-EXT - CNI</p> | <p>Replace Z303, card BR and recheck.</p> | <p>Check register drive in distributor at test point BR4.</p> | <p>7</p> |
| | <p>TYPE 2 Pos-4 TP-CNI H-100usec/D V-2V/D T-EXT + CNI</p> | <p>Replace Z321, card CN and recheck.</p> | <p>Check stop inserter in distributor at test point CNI.</p> | <p>8</p> |
| | <p>TYPE 1 Pos-6 TP-CNI H-2msec/D V-2V/D T-EXT + CNI</p> | <p>Readjust or replace Z305, card CM and recheck.</p> | <p>Check start delay time-out. Should be half a bit (475 usec) in distributor at test point CMI.</p> | <p>9</p> |
| | <p>Pos-4 TP-CM1 H-100usec/D V-2V/D T-EXT + BR3</p> | <p>Readjust or replace Z311, card CH and recheck.</p> | <p>Check start-stop oscillator frequency by checking output of squaring amplifier in distributor at test point CF2, trigger scope on INT +.</p> | <p>10</p> |

Receiving distributor or data set failure



| | | | | |
|---|---|--|--|--|
| | <p>8</p> <p>Check stop inserter in distributor at test point CN1.</p> | <p>See scope display. If correct, proceed to Step 9.</p> | <p>Replace Z321, card CN and recheck.</p> | <p>TYPE 2 Pos-4 TP-CN1 H-100usec/D V-2V/D T-EXT + CN1</p>  <p>TYPE 1 Pos-6 TP-CN1 H-2msec/D V-2V/D T-EXT + CN1</p>  |
| <p>9</p> <p>Check start delay time-out. Should be half a bit (475 usec) in distributor at test point CM1.</p> | <p>See scope display. If correct, proceed to Step 10.</p> | <p>Readjust or replace Z305, card CM and recheck.</p> | <p>Pos-4 TP-CM1 H-100usec/D V-2V/D T-EXT + BR3</p>  | |
| <p>10</p> <p>Check start-stop oscillator frequency by checking output of squaring amplifier in distributor at test point CF2, trigger scope on INT +.</p> | <p>Pulse should be 952 +7 usec apart. Proceed to Step 11.</p> | <p>Readjust or replace Z311, card CH and recheck.</p> | <p>Pos-4 TP-CF2 H-100usec/D V-2V/D T-INT +</p>  | |

TABLE J (Continued)

Tape Receiver-Trouble Shooting (Garbled Message)

| Symptom | Step | Action | Normal Indication and Procedure | Abnormal Indication and Procedure | Scope Displays and Setting |
|---|------|--|---|--|--|
| Intermittent or weak shift of transfer prime pulses | 11 | In distributor check shift delay emitter-follower at test point BC2. | See scope display. If correct, proceed to Step 14. | If incorrect, proceed to Step 12. |  <p>Pos-2 TP-BC2 H-2usec/D V-2V/D T-INT +</p> |
| | 12 | Check shift delay pulse amplifier in distributor at test point BD3. | See scope display. If correct, replace Z309, card BC and recheck Step 11. | If incorrect, proceed to Step 13. |  <p>Pos-2 TP-BD3 H-2usec/D V-2V/D T-INT +</p> |
| | 13 | Check shift delay in distributor at test point BF1. | See scope display. If correct, replace Z308, card BD and recheck Step 12. Note: Time-out not less than 50 usec. | If incorrect, replace Z307, card BF and recheck. Proceed to Step 14. |  <p>Pos-4 TP-BF1 H-100usec/D V-2V/D T-INT +</p> |
| | 14 | Check "set 1" delay emitter follower in distributor at test point BC5. | See scope display. If correct, proceed to Step 17. | If incorrect, proceed to Step 15. |  <p>Pos-2 TP-BC5 H-2usec/D V-2V/D T-INT +</p> |
| | 15 | Check "set 1" delay pulse amplifier in distributor at test point BD4. | See scope display. If correct, replace Z309, card BC and recheck Step 14. | If incorrect, proceed to Step 16. |  <p>Pos-2 TP-BD4 H-2usec/D V-2V/D T-INT +</p> |
| | 16 | Check "set 1" delay in distributor at test point BE1. | See scope display. If correct, replace Z308, card BD and recheck Step 15. Note: Time-out not less than 200 usec. | If incorrect, replace Z306, card BE and recheck. |  <p>Pos-4 TP-BE1 H-100usec/D V-2V/D T-INT +</p> |
| | 17 | In converter check transfer emitter follower at test point CH2. | See scope display. If correct, omit Steps 18 through 23. | If incorrect, proceed to Step 18. |  <p>Pos-2 TP-CH2 H-2usec/D V-2V/D</p> |

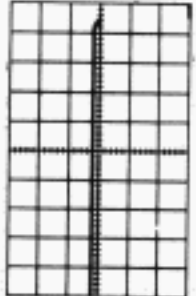
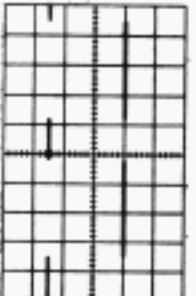
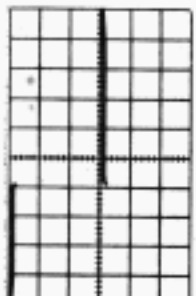
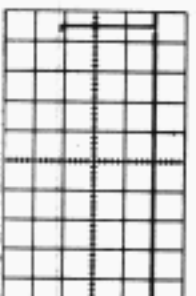
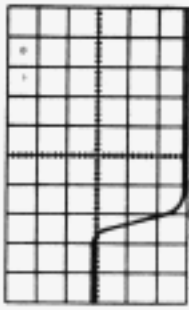
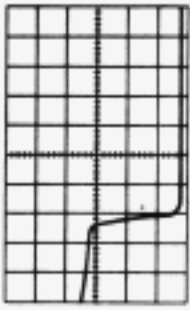
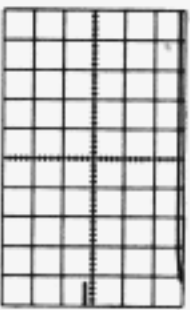
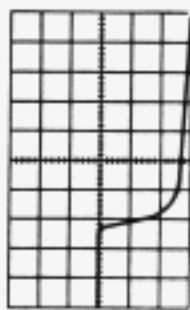
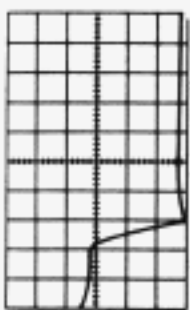
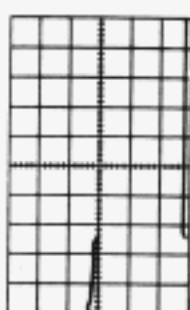
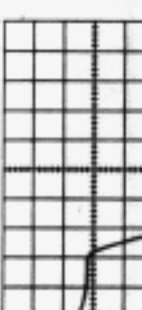
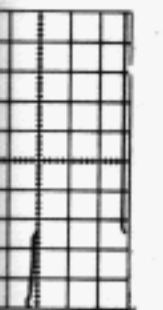
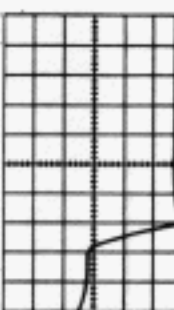
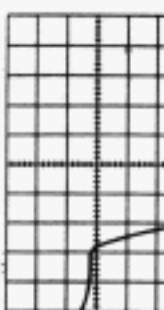
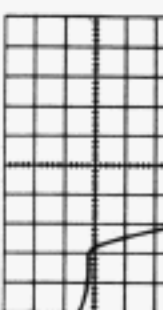
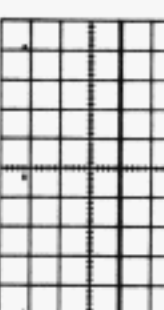
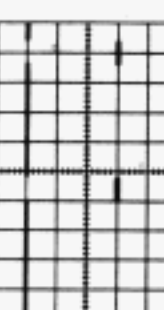
| | | | | | |
|----|---|---|--|---|---|
| 16 | BE1. | card BD and recheck Step 15. Note: Time-out not less than 200 usec. | check. |  | H-100usec/D V-2V/D T-INT + |
| 17 | In converter check transfer emitter follower at test point CH2. | See scope display. If correct, omit Steps 18 through 23. | If incorrect, proceed to Step 18. |  | Pos-2 TP-CH2 H-2usec/D V-2V/D T-INT + |
| 18 | Check inhibit gate in converter at test point CG4. | See scope display. If correct, replace Z409, card CH and recheck Step 17. | If incorrect, proceed to Step 19. |  | Pos-2 TP-CG4 H-2usec/D V-2V/D T-INT + |
| 19 | Check transfer pulse amplifier in converter at test point BF3. | See scope display. If correct, replace Z402, card CG and recheck Step 18. | If incorrect, proceed to Step 20. |  | Pos-2 TP-BF3 H-2usec/D V-2V/D T-INT + |
| 20 | Check transfer one-shot in converter at test point BH1. | See scope display. If correct, replace Z408, card BF and recheck Step 20. | If incorrect, proceed to Step 21. |  | Pos-6 TP-BH-1 H-2msec/D V-2V/D T-INT + |
| 21 | Check variable pulse delay in converter at test point BG2. | See scope display. If correct, replace Z407, card BH and recheck Step 20. | If incorrect, proceed to Step 22. |  | Pos-6 TP-BG2 H-2msec/D V-2V/D T-INT + |
| 22 | Check transfer prime in converter at test point BJ3. | See scope display. If correct, replace Z406, card BG and recheck Step 21. | If incorrect, proceed to Step 23. |  | Pos-6 TP-BJ3 H-2msec/D V-2V/D T-EXT + BGC |
| 23 | Check pickup on terminal in converter at CDJ. | See scope display. If correct, replace Z403, card BJ and recheck Step 22. | If incorrect, replace Z404, card CD and recheck. |  | Pos-6 TP-CDJ H-2msec/D V-2V/D T-INT + |
| | | | | | |

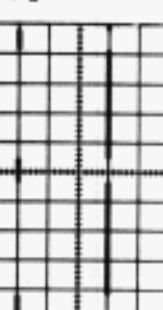
Transfer circuitry



| | | | | | |
|--------------------|----|--|---|--|--|
| Transfer circuitry | 20 | Check transfer one-shot in converter at test point BH1. | See scope display. If correct, replace Z408, card BF and recheck Step 20. | If incorrect, proceed to Step 21. | <p>Pos-6 TP-BH-1 H-2msec/D V-2V/D T-INT +</p>  |
| | 21 | Check variable pulse delay in converter at test point BG2. | See scope display. If correct, replace Z407, card BH and recheck Step 20. | If incorrect, proceed to Step 22. | <p>Pos-6 TP-BG2 H-2msec/D V-2V/D T-INT +</p>  |
| | 22 | Check transfer prime in converter at test point BJ3. | See scope display. If correct, replace Z406, card BG and recheck Step 21. | If incorrect, proceed to Step 23. | <p>Pos-6 TP-BJ3 H-2msec/D V-2V/D T-EXT + BGC</p>  |
| | 23 | Check pickup on terminal in converter at CDJ. | See scope display. If correct, replace Z403, card BJ and recheck Step 22. | If incorrect, replace Z404, card CD and recheck. | <p>Pos-6 TP-CDJ H-2msec/D V-2V/D T-INT +</p>  |

TABLE K

Tape Receiver-Trouble Shooting (Dropping or Addition of Marks and Tape Feeding Failure)

| Symptom | Step | Action | Normal Indication and Procedure | Abnormal Indication and Procedure |
|--|------|---|---|--|
| Magnet pulser or tape punch maladjustment | 1 | <p>A. If dropping marks, with motors on press LTRS FO and observe punched tape.</p> <p>B. If adding marks, place module TEST switch in TEST position.</p> <p>C. If feeding failure occurs, proceed to Step 4.</p> <p>Note: After trouble has been cleared always place test switch in normal position and recheck operation of the receiver by calling the test center and receiving a test message to ensure proper operation.</p> | <p>Tape should contain all marks. Proceed to Step 2.</p> <p>Should punch blank tape. Proceed to Step 2.</p> | <p>Interchange cards CS through CK one at a time and recheck.</p> <p>If trouble is in same level, make a visual check of tape punch for maladjustment, broken springs, etc. Check for loose wires and connectors or defective components associated with the errored level. Refer to section referring to tape punch adjustments.</p> <p>If trouble changes level when cards are interchanged, replace defective card and recheck.</p> |
| Storage register or signal register failure | 2 | <p>Replace storage register card of failing level and repeat Step 1.</p> | <p>Punch tape should contain all marks or all spaces depending on which test is made in Step 1.</p> | <p>If trouble continues in same level, proceed to Step 3. If trouble is cleared, retest receiver with test center.</p> |
| Signal register failures or defective wiring | 3 | <p>If marks are being picked up, in distributor, replace signal register card of failing level with known working card. Place test switch in TEST position and observe that tape punch is feeding blank tape.</p> | <p>Tape punch is feeding blank tape. Retest with test center.</p> | <p>If trouble continues in the same level, turn power off and using VOM check wiring between converter and distributor of the particular level that is failing. Check for loose connections in modules and correct as required.</p> |
| | | <p>Replace feed magnet</p> | <p>Punch should feed out</p> | <p>If punch does not feed</p> |

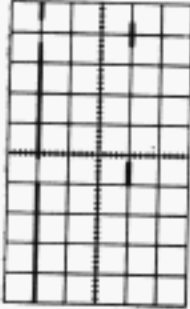
| | | | | | |
|---|---|---|--|---|--|
| Signal register failures or defective wiring | 3 | register card of failing level with known working card. Place test switch in TEST position and observe that tape punch is feeding blank tape. | | VOM check wiring between converter and distributor of the particular level that is failing. Check for loose connections in modules and correct as required. | |
| Tape feed failure complete failure not feeding at all | 4 | Replace feed magnet pulser circuit card and depress LTRS FO button. | Punch should feed out letters tape. Recheck Step 29 of Table H. | If punch does not feed tape, make a visual check of feed mechanism for possible maladjustment, broken or worn parts. Proceed to Step 5. | |
| Punch feed failure | 5 | If punch condition appears to be normal, depress LTRS FO button and note whether feed magnet is energized. | Feed magnet armature should be pulled in and tape should feed. If tape does not feed, punch feeding mechanism is at fault. This can be checked using a small screwdriver and holding feed magnet armature down. Care should be used when doing this. | If magnet is not energized, use wave form indicator and check output of feed magnet pulser. See Step 29 of Table H. If signal is not correct, turn power off and, using VOM, check the wiring of feed magnet circuit and associated components. Replace defective components, or correct wiring and recheck. | |
| Extra feed (inserted blank) or dropping of feed | 6 | Call test center, and with test signal received (test pattern) check output of tape punch. | Test pattern should be punched as shown on test tape. | If trouble is due to extra feed, extra blanks will appear in punched tape. Make visual inspection of punch and clean off excess lubricants on feed magnet armatures. Note added friction and lubricate if necessary. A slight change in pickup adjustment may clear this difficulty. However, a test should be conducted to make certain another trouble has not been inserted. If trouble is due to feed failure, an overlap of punched characters will appear. Proceed to Step 7. | |

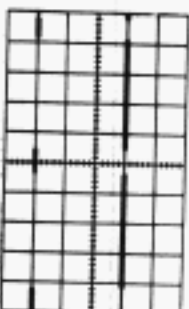
| | | |
|---|--|--|
| | | |
| <p>oil and, using VOM, check the wiring of feed magnet circuit and associated components. Replace defective components, or correct wiring and re-check.</p> | <p>If trouble is due to extra feed, extra blanks will appear in punched tape. Make visual inspection of punch and clean off excess lubricants on feed magnet armatures. Note added friction and lubricate if necessary. A slight change in pickup adjustment may clear this difficulty. However, a test should be conducted to make certain another trouble has not been inserted. If trouble is due to feed failure, an overlap of punched characters will appear. Proceed to Step 7.</p> | |
| <p>holding feed magnet armature down. Care should be used when doing this.</p> | <p>Test pattern should be punched as shown on test tape.</p> | |
| | <p>Call test center, and with test signal received (test pattern) check output of tape punch.</p> | |
| <p>Extra feed (inserted blank) or dropping of feed</p> | <p>6</p> | |

TABLE K (Continued)

Tape Receiver-Trouble Shooting (Dropping or Addition of Marks and Tape Feeding Failure)

| Symptom | Step | Action | Normal Indication and Procedure | Abnormal Indication and Procedure | |
|----------------------------|------|--|--|---|--|
| Feed magnet pulser failure | 7 | <p>The preceding step may not resolve the difficulty, and the trouble may be in the feed magnet pulser. Receiving a test signal and using signal monitor, check output of the feed magnet pulser at test terminal CJA. Trigger indicator on EXT + on test point BF3 and note operation of magnet pulser.</p> | <p>See Step 27 of Table H. If signal is normal, punch pickup or feed mechanism may be out of adjustment, or worn parts may be the problem. A quick check can be made by loosening the pickup and changing the position. Note and mark the original position. To retard pickup pulse, move pickup in clockwise direction as viewed from front. To advance pickup signal, move coil in counterclockwise direction. Further adjustments should be made according to the section covering adjustments and procedure.</p> | <p>Replace defective element and check time-out. Adjust magnet pulser until time-out is approximately 4.5 +0.2.</p> | |
| | | | | | |

| | |
|--|--|
| | |
| | |
| | |
| | |
| | |
| | |
| | |
| | |
| | |
| | |
| | |

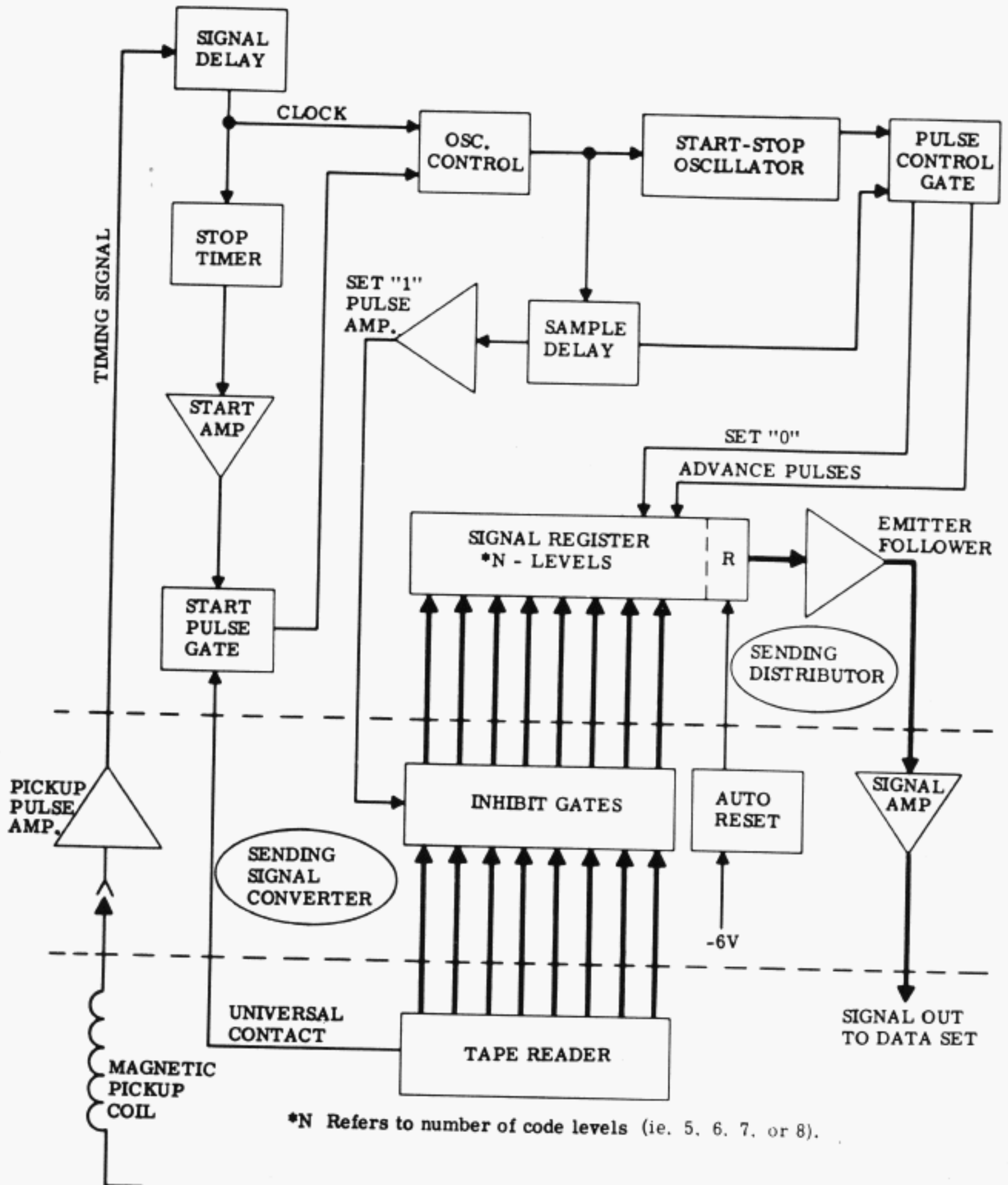

Figure 4. Tape Sender - Electronic Block Diagram

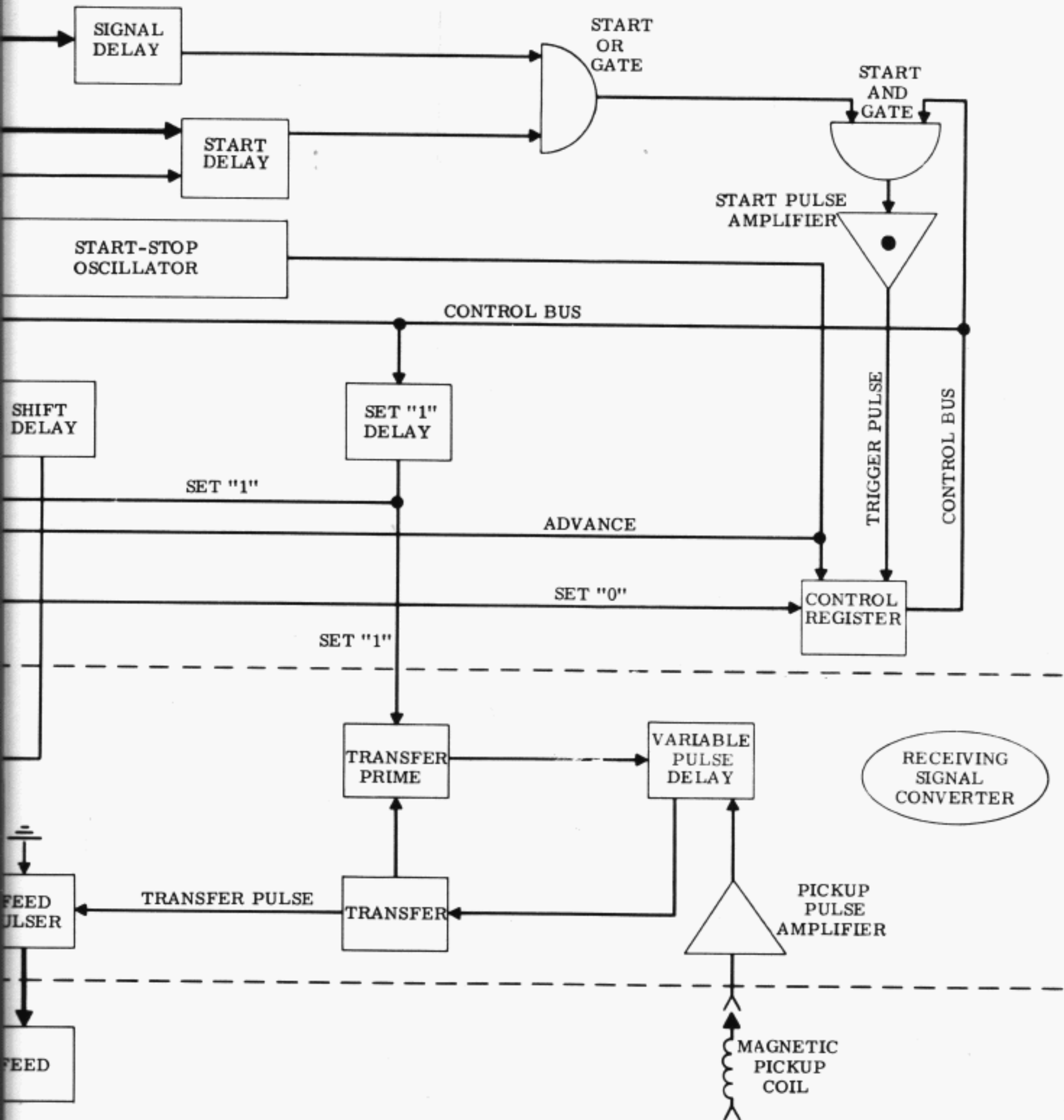
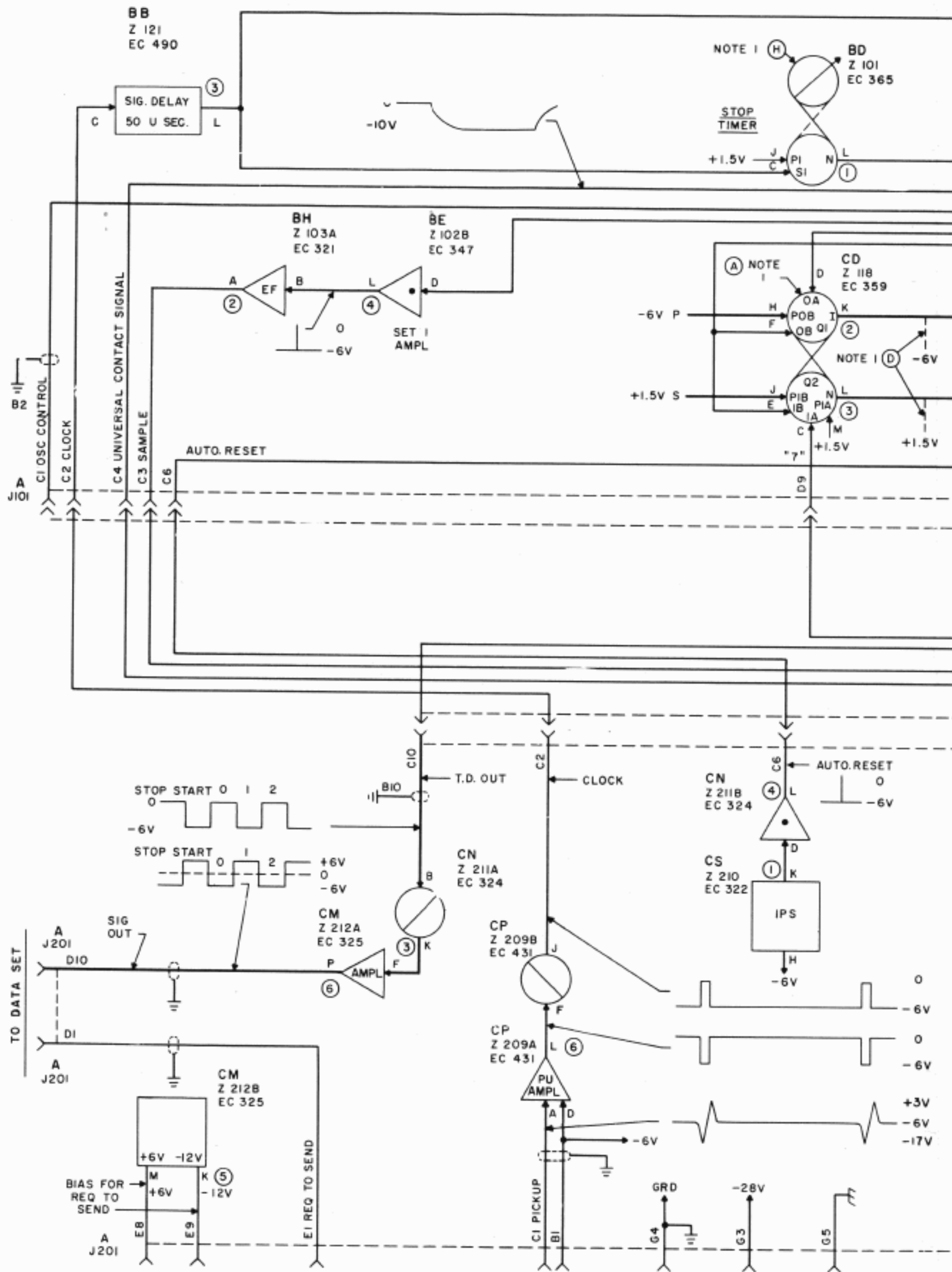
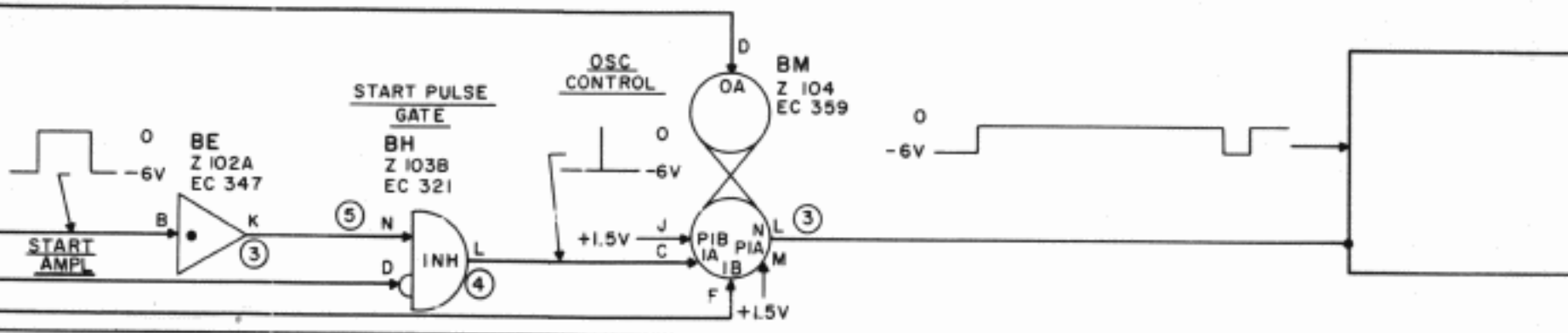

Figure 5. Tape Receiver - Electronic Block Diagram



01
365



B
359

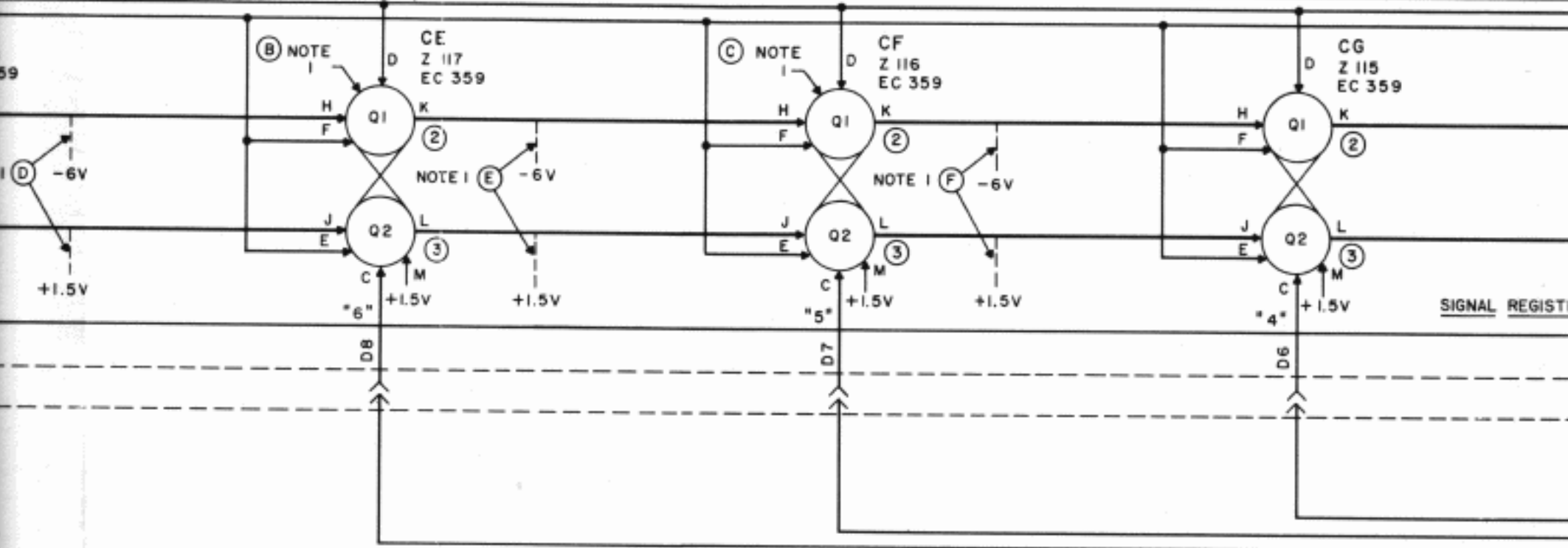

RESET
0
-6V

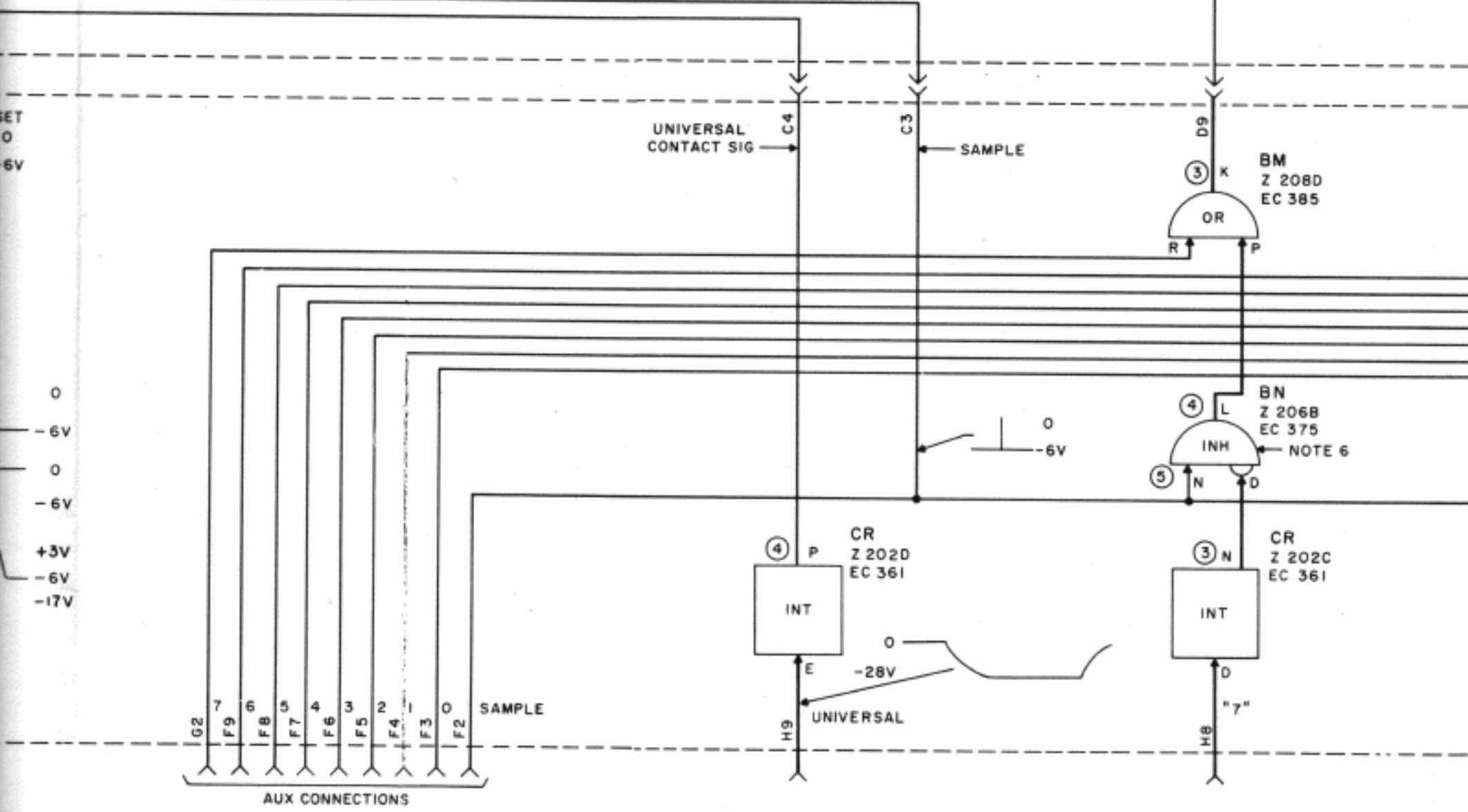

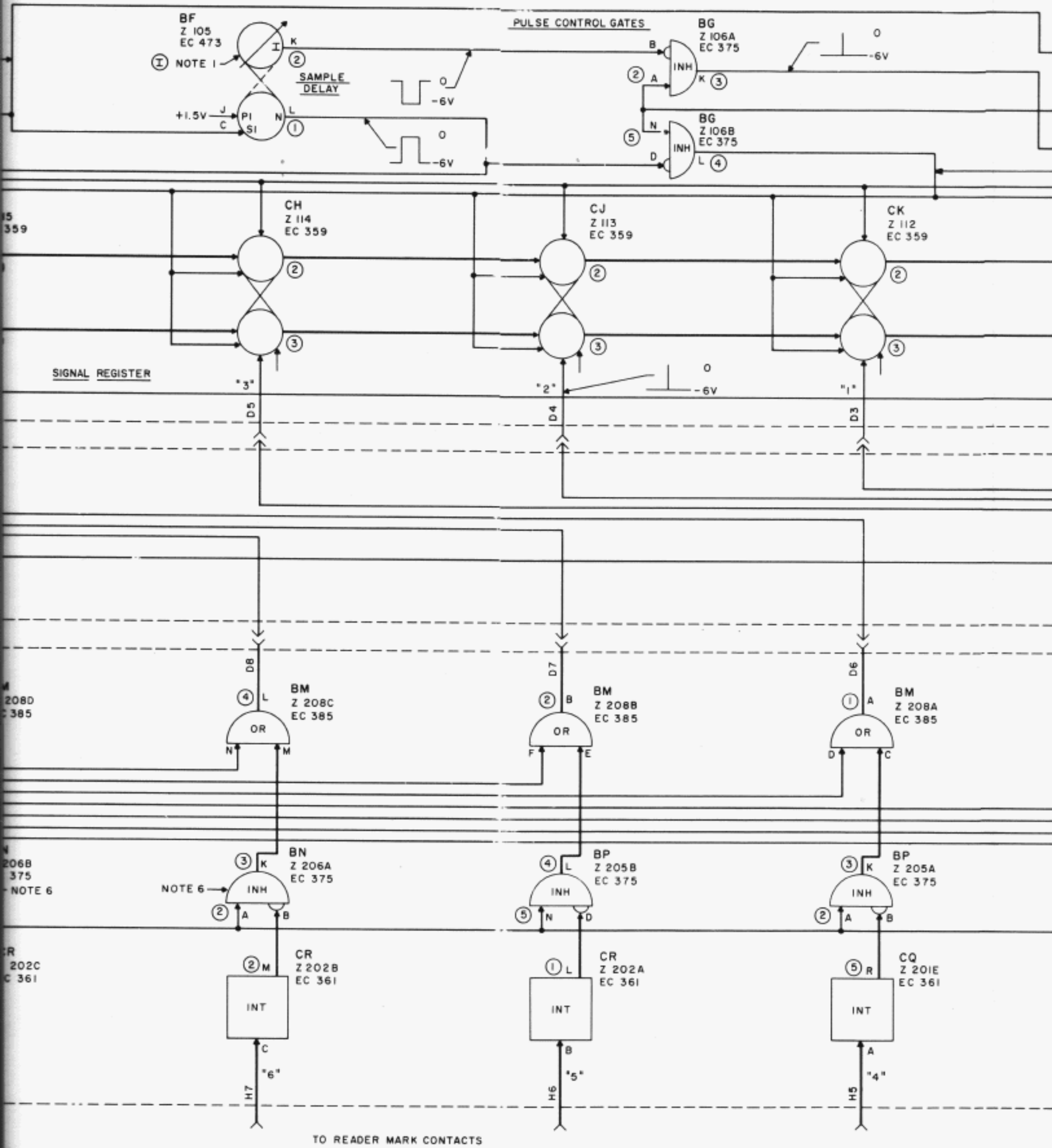

5
359

208D
385

206B
375
NOTE 6

CR
202C
361

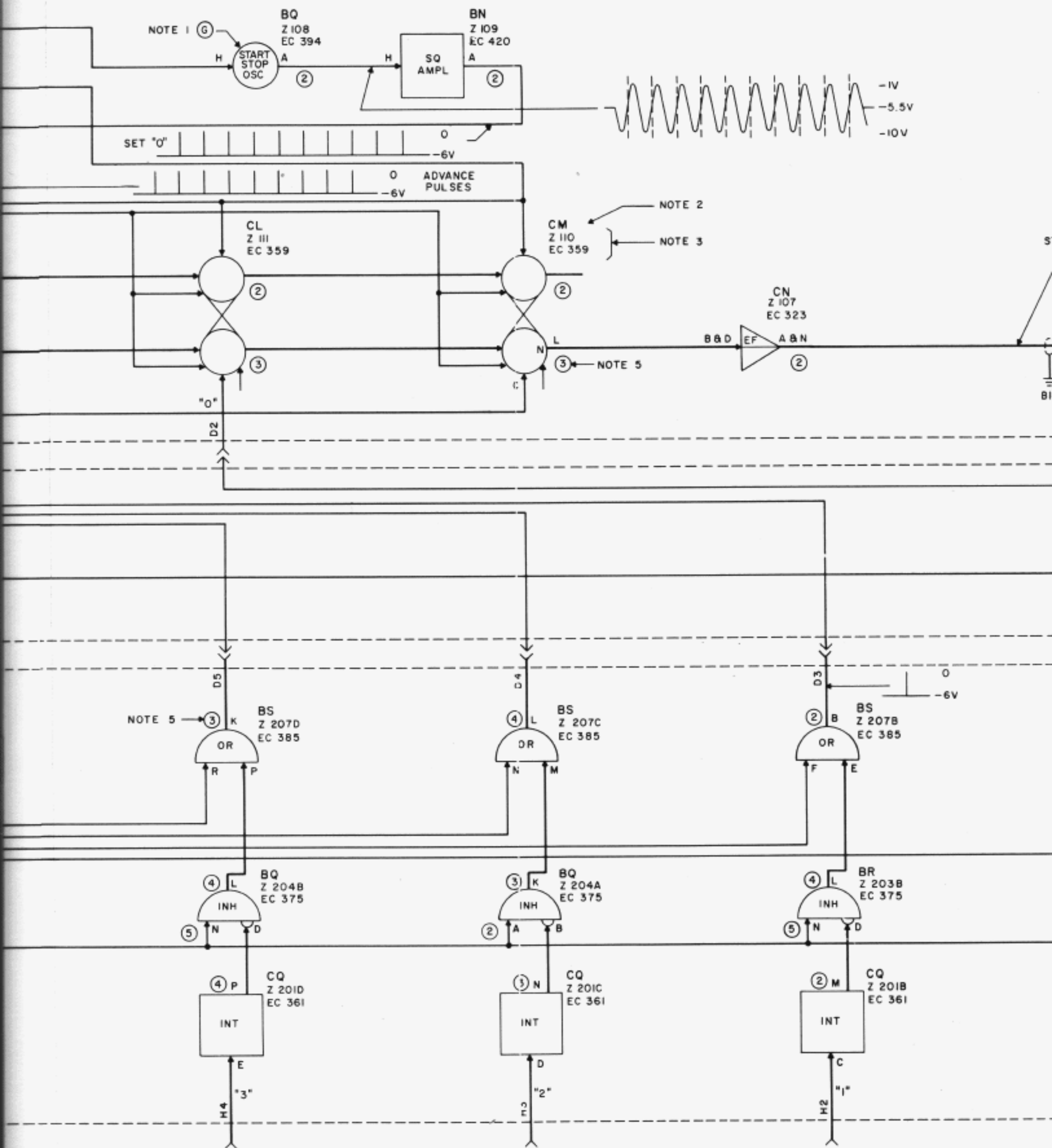

6. TTSC 500 (5 AND 6 LEVEL CODE) CIRCUIT ELEMENTS Z 206A AND Z 206B ARE OMITTED; TTSC 800 (7 AND 8 LEVEL CODE), Z 206A AND Z 206B ARE INCLUDED.

NOTES:

1. REFER TO VARIATIONS IN APPARATUS CODES CHART.
2. DENOTES POSITION IN MODULE.
3. Z NUMBER DENOTES CIRCUIT ELEMENT AND EC NUMBER REFERS TO CIRCUIT BOARD.
4. FOR ACTUAL WIRING DIAGRAM REFER TO 3835WD AND 4438WD.
5. (2) NUMBER IN CIRCLE DENOTES TEST POINT ON CIRCUIT CARD.

VOLTAGES REQUIRED FOR FLIP-FLOP OPERATION OF EC359 CIRCUIT CARD

| SET "0" = SPACE | | SET "1" = MARK | |
|--|---------------|--|--------------|
| Q1 OFF | OUTPUT L = -6 | Q1 ON | OUTPUT L = 0 |
| Q2 ON | K = 0 | Q2 OFF | K = -6 |
| + PRIME ON H AND TRIGGER ON F | | + PRIME ON J AND TRIGGER ON E | |
| OR | | OR | |
| PERMANENT +1.5 PRIME (INTERNAL) AND TRIGGER ON D | | PERMANENT +1.5 PRIME ON M AND TRIGGER ON C | |

L = NORMAL OUTPUT
K = INVERTED OUTPUT

| | TYPE 1 | TYPE 2 | |
|----------|-----------------------|-----------------|------|
| CODE-TTD | 603 | 804 | |
| BIT RATE | 1050 | 1050 | |
| LEVEL | 6 | 5 TO 8 | |
| A | EC359 | X | |
| B | EC359 | X | |
| C | EC359 | X | |
| D | STRAPS | - | |
| E | STRAPS | X | |
| F | STRAPS | - | |
| G | START-STOP OSCILLATOR | EC394 0.952MSEC | SAME |
| H | ADJUST TO | 900μSEC | SAME |
| I | ADJUST TO | 475μSEC | SAME |

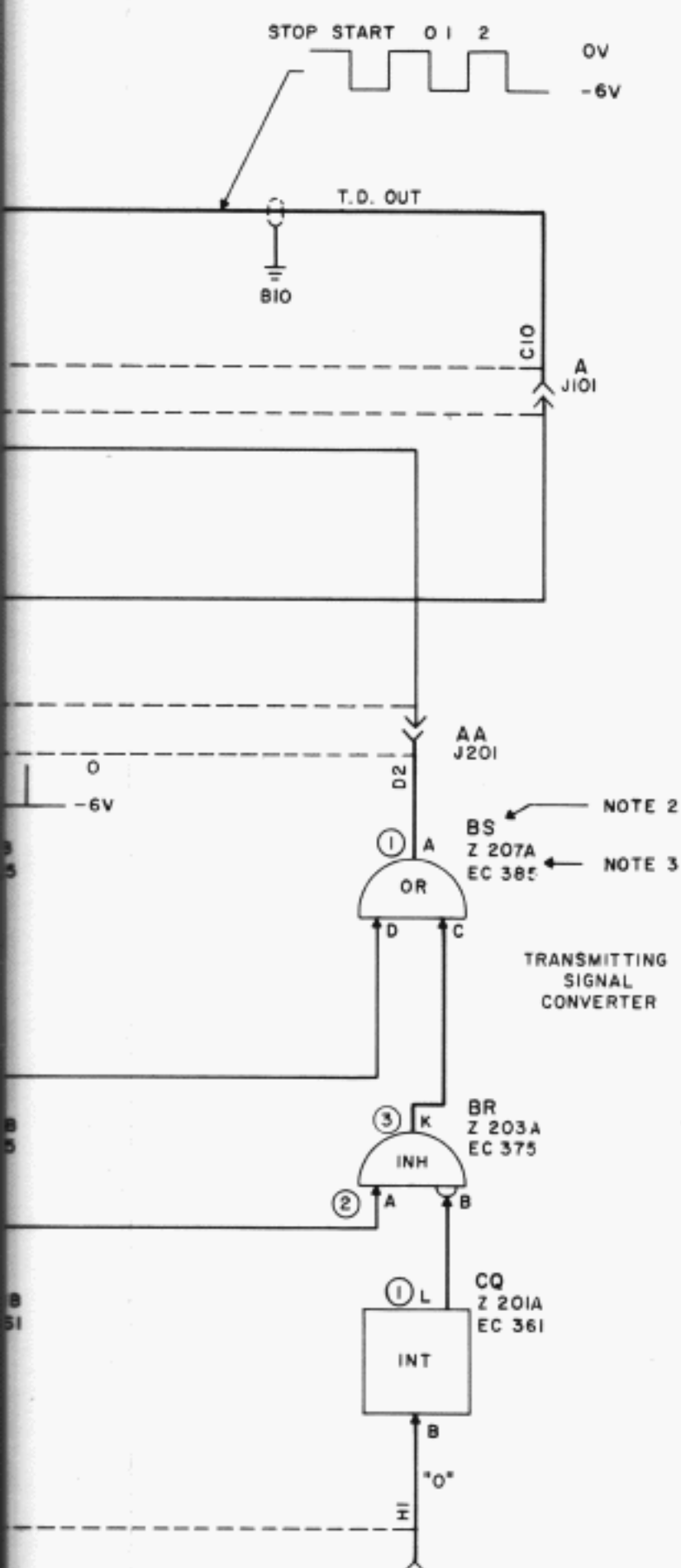
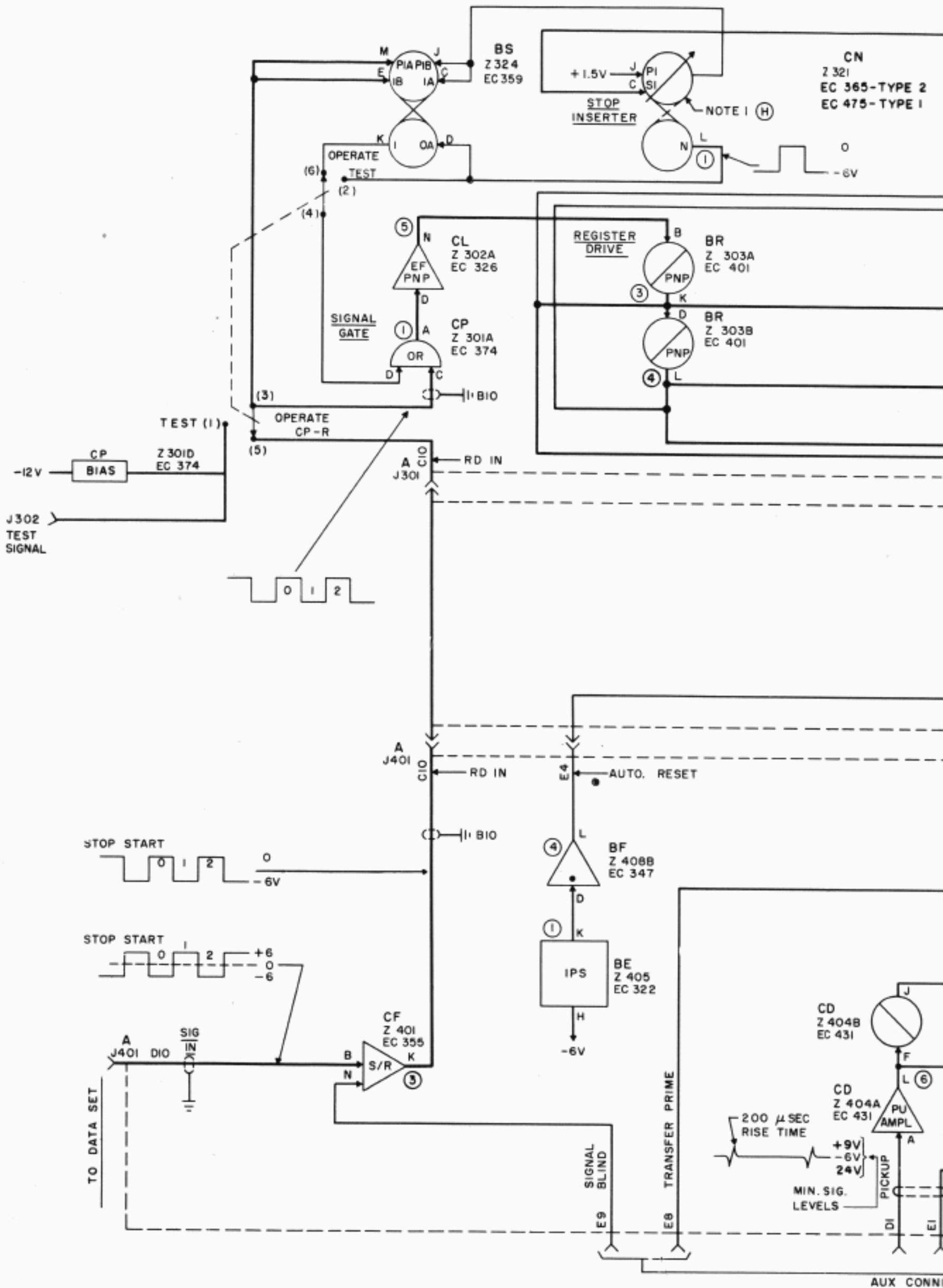
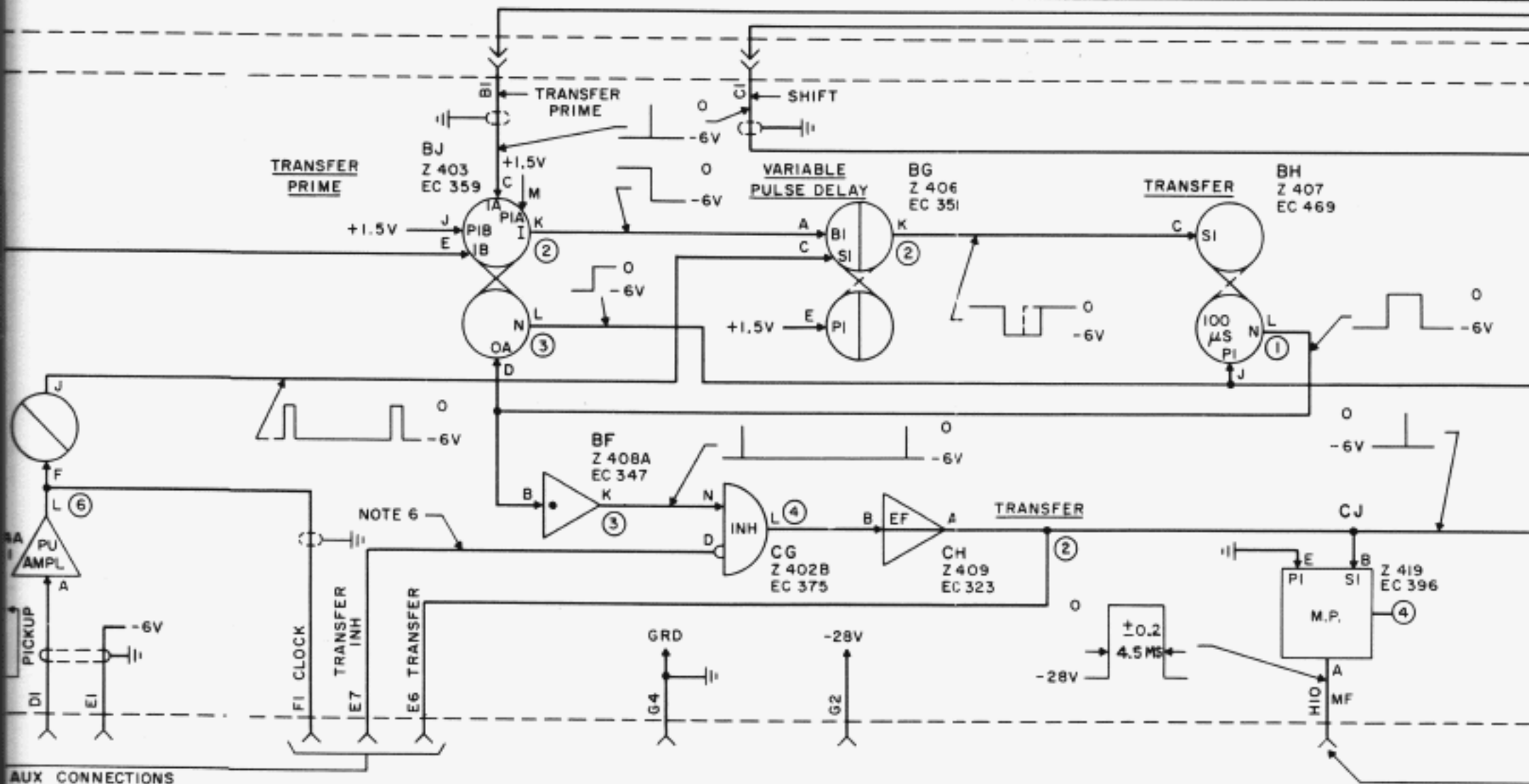
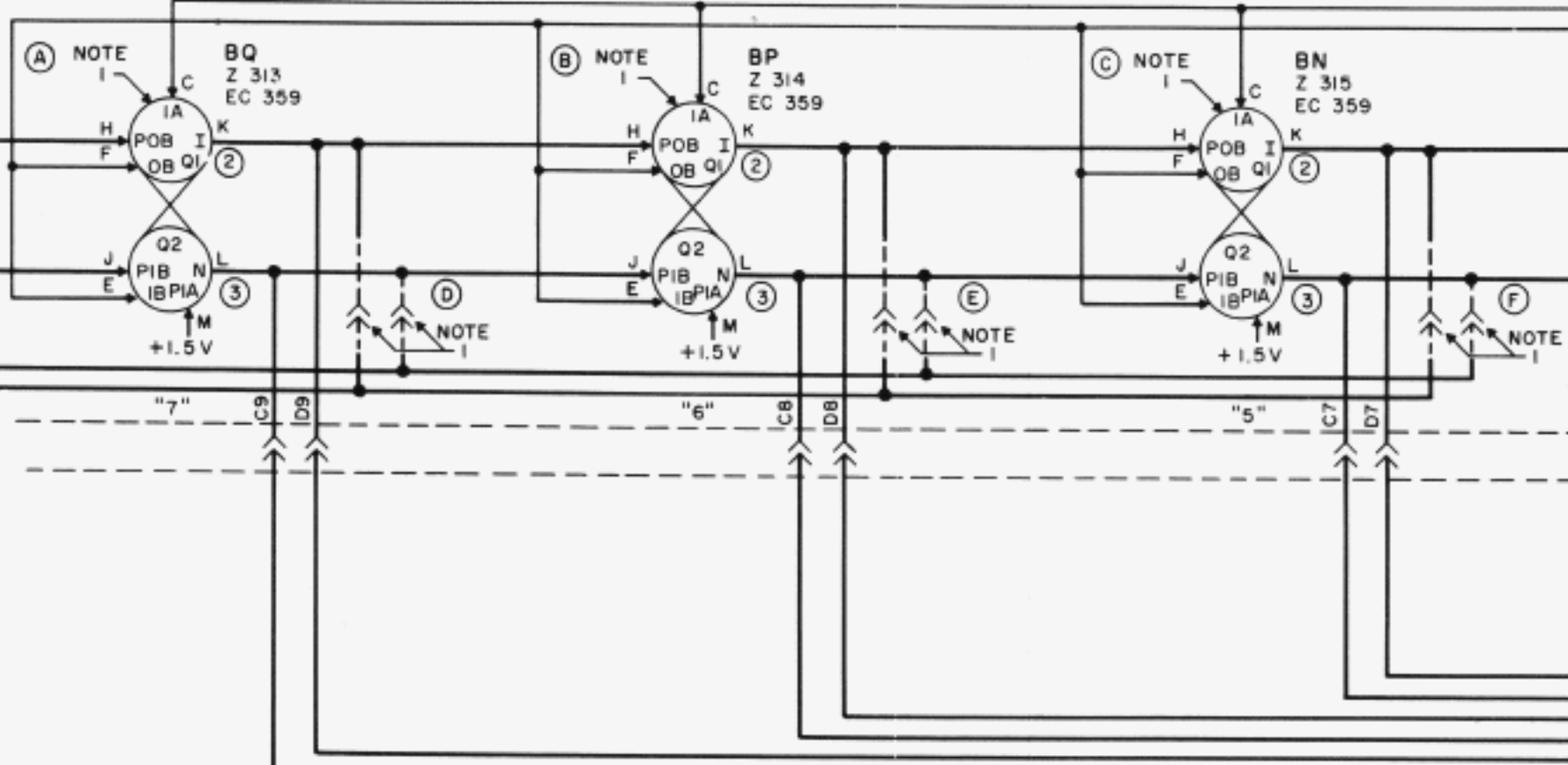
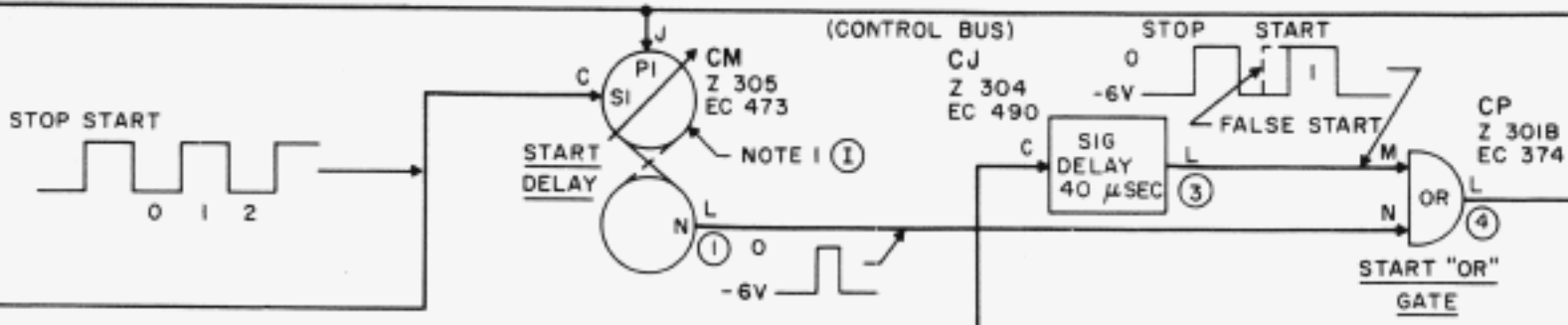

Figure 6. Tape Sender - Electronic Logic Diagram



AUX CONN

3-TYPE 2
3-TYPE 1



AUX CONNECTIONS

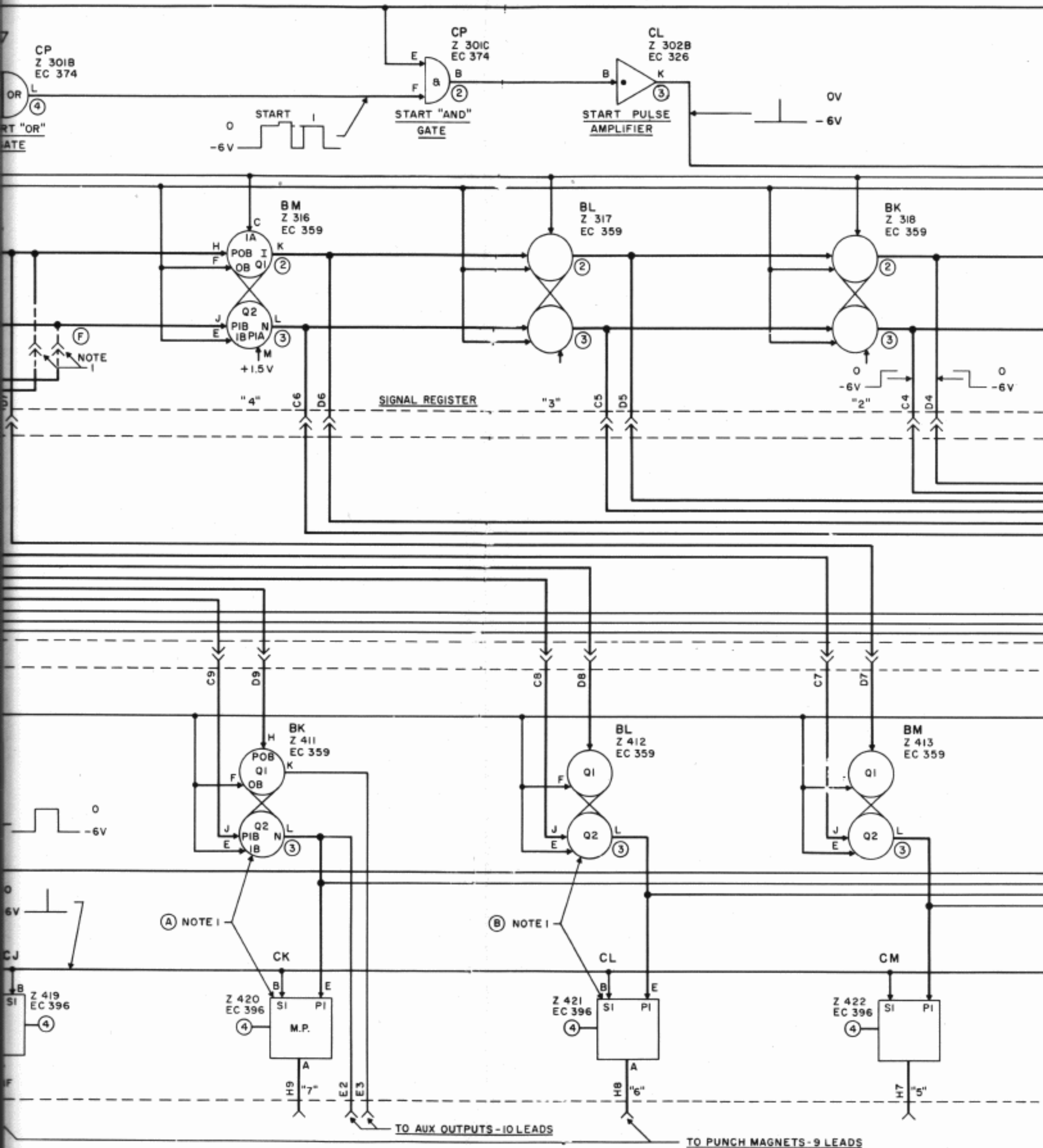

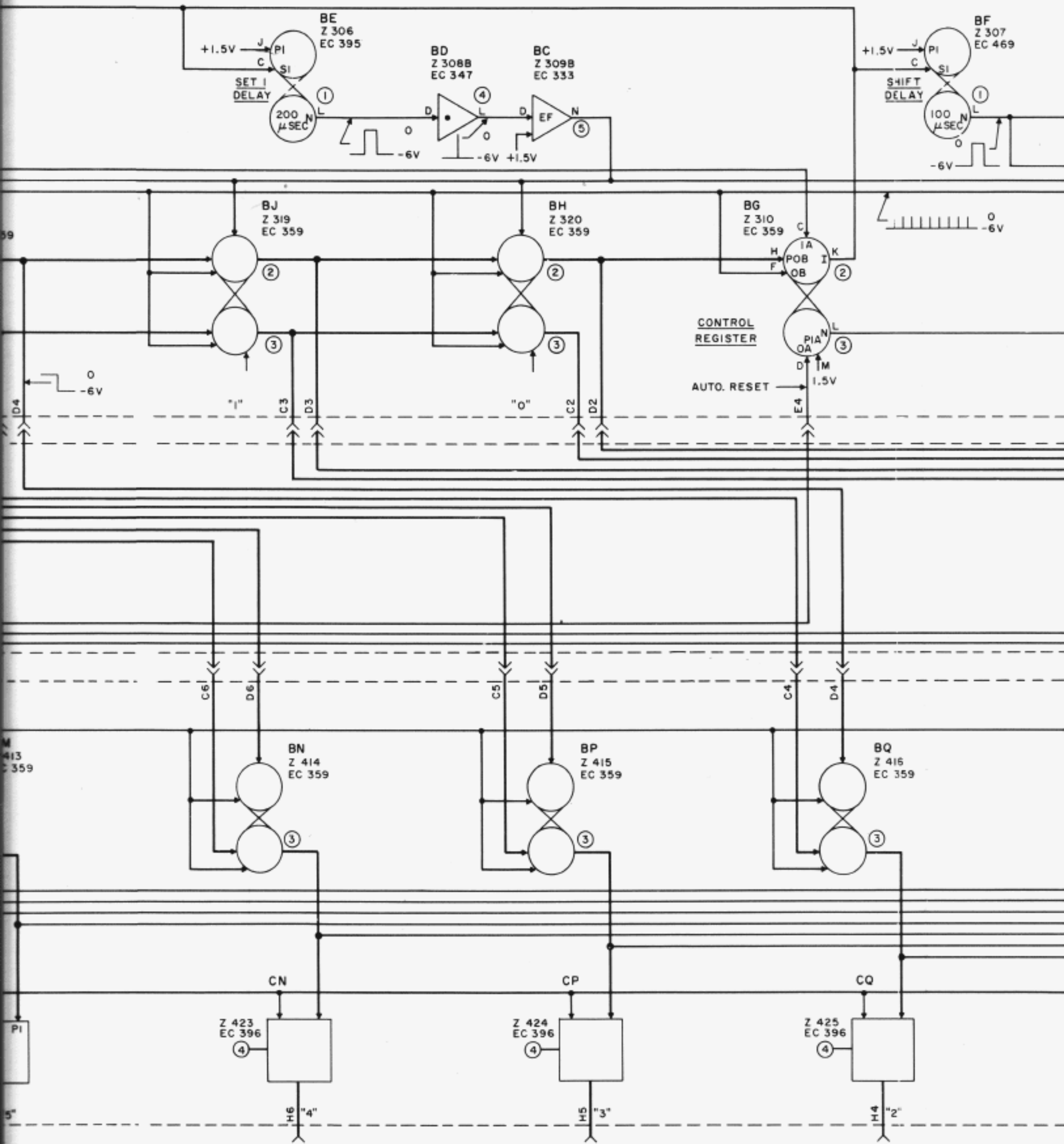

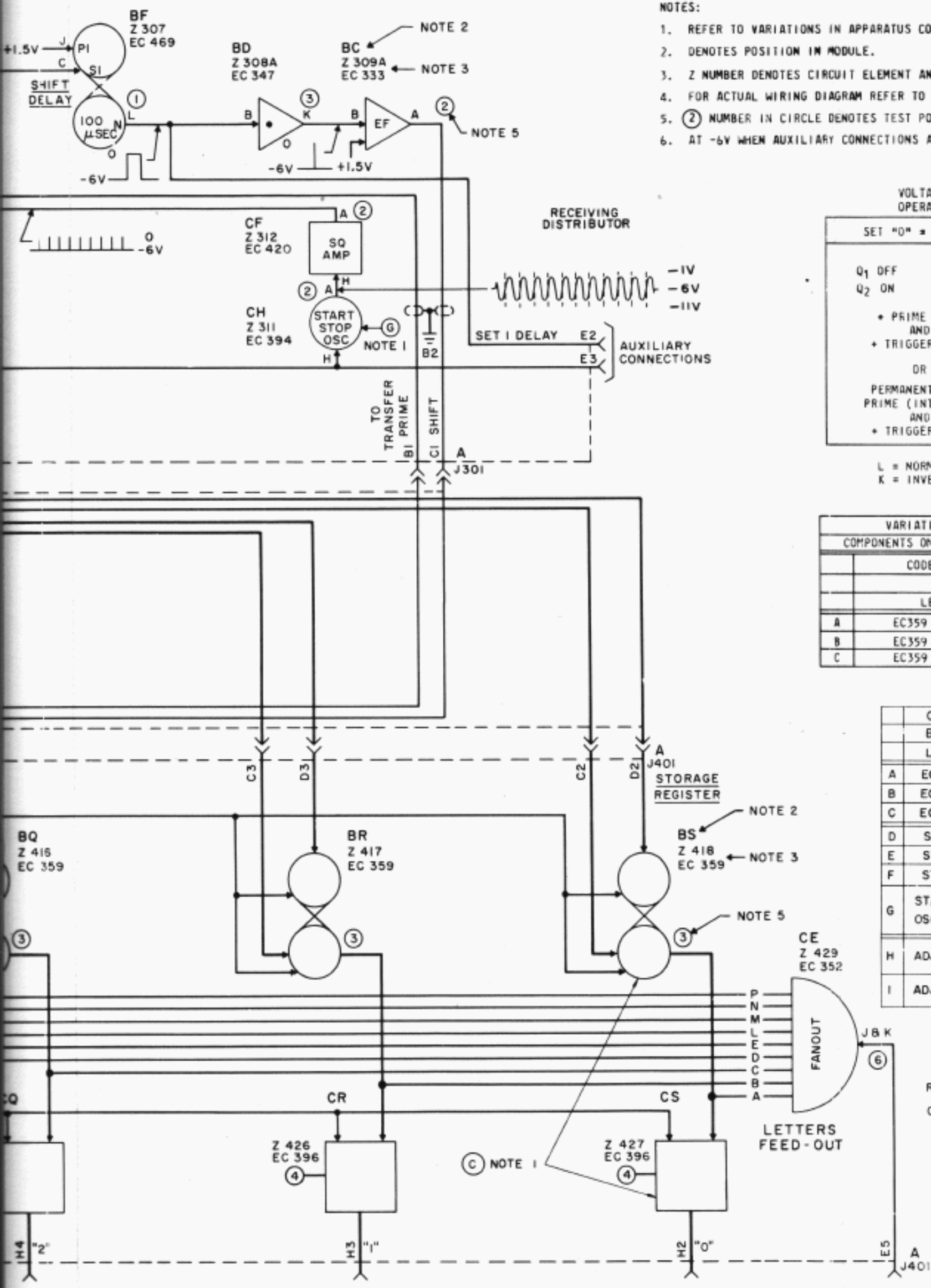

NOTES:

1. REFER TO VARIATIONS IN APPARATUS CODES CHART.
2. DENOTES POSITION IN MODULE.
3. Z NUMBER DENOTES CIRCUIT ELEMENT AND EC NUMBER REFERS TO CIRCUIT BOARD.
4. FOR ACTUAL WIRING DIAGRAM REFER TO 3837WD AND 4440WD.
5. ② NUMBER IN CIRCLE DENOTES TEST POINT ON CIRCUIT CARD.
6. AT -6V WHEN AUXILIARY CONNECTIONS ARE NOT USED.

VOLTAGES REQUIRED FOR FLIP-FLOP OPERATION OF EC359 CIRCUIT CARD

| SET "0" = SPACE | | SET "1" = MARK | |
|--|---------------|--|--------------|
| Q1 OFF | OUTPUT L = -6 | Q1 ON | OUTPUT L = 0 |
| Q2 ON | K = 0 | Q2 OFF | K = -6 |
| + PRIME ON H AND TRIGGER ON F | | + PRIME ON J AND TRIGGER ON E | |
| OR | | OR | |
| PERMANENT +1.5 PRIME (INTERNAL) AND TRIGGER ON D | | PERMANENT +1.5 PRIME ON M AND TRIGGER ON C | |

L = NORMAL OUTPUT
K = INVERTED OUTPUT

VARIATIONS IN APPARATUS CODES CHART
COMPONENTS OMITTED OR INCLUDED - OMIT X INCLUDE

| CODE-TRSC | 500 | 600 | 700 | 800 |
|-----------|-----------------|-----|-----|-----|
| LEVEL | 5 | 6 | 7 | 8 |
| A | EC 359 & EC 396 | - | - | X |
| B | EC 359 & EC 396 | - | X | X |
| C | EC 359 & EC 396 | - | X | X |

| | TYPE 1 | TYPE 2 | |
|----------|-----------------------|-------------------------------------|-------------------------------------|
| CODE-TRD | 603 | 804 | |
| BIT RATE | 1050 | 1050 | |
| LEVEL | 6 | 5 TO 8 | |
| A | EC 359 | X | |
| B | EC 359 | X | |
| C | EC 359 | X | |
| D | STRAPS | - | |
| E | STRAPS | X | |
| F | STRAPS | - | |
| G | START-STOP OSCILLATOR | EC 394 0.95 M SEC | SAME |
| H | ADJUST TO | 2.9 M SEC +0.1 M SEC -0 M SEC | 950 U SEC +100 U SEC -0 U SEC |
| I | ADJUST TO | 475 U SEC | SAME |

Fig

NOTES:

1. REFER TO VARIATIONS IN APPARATUS CODES CHART.
2. DENOTES POSITION IN MODULE.
3. Z NUMBER DENOTES CIRCUIT ELEMENT AND EC NUMBER REFERS TO CIRCUIT BOARD.
4. FOR ACTUAL WIRING DIAGRAM REFER TO 3837WD AND 4440WD.
5. (2) NUMBER IN CIRCLE DENOTES TEST POINT ON CIRCUIT CARD.
6. AT -6V WHEN AUXILIARY CONNECTIONS ARE NOT USED.

NOTE 5

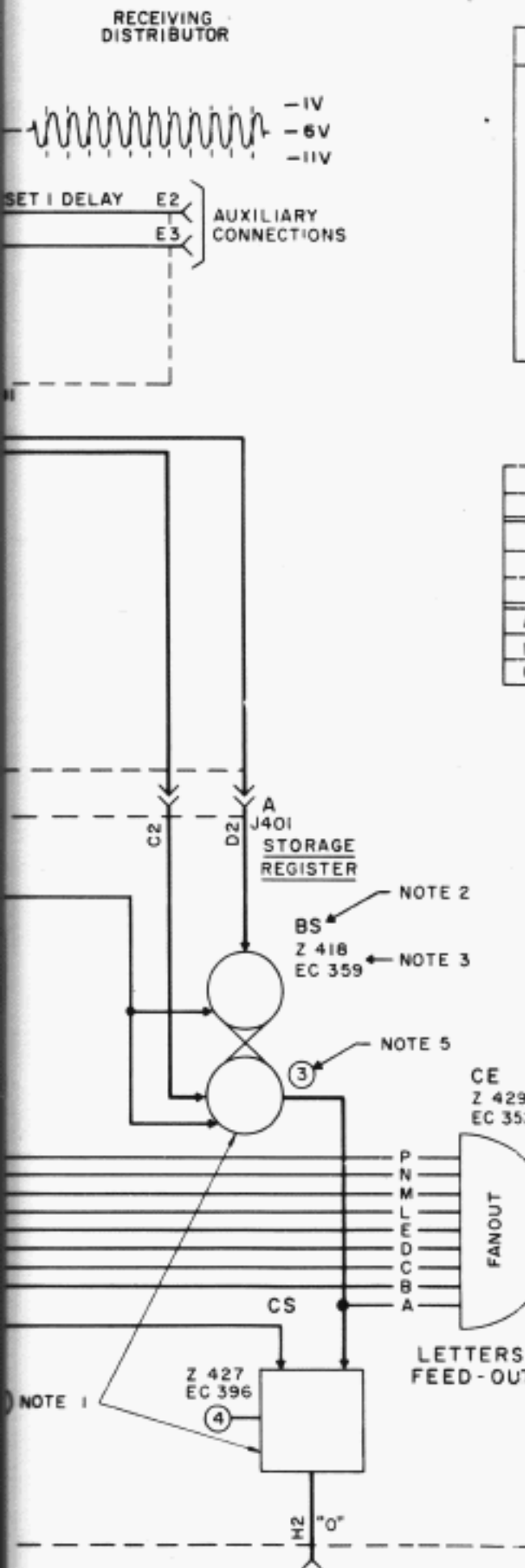

VOLTAGES REQUIRED FOR FLIP-FLOP OPERATION OF EC359 CIRCUIT CARD

| SET "0" = SPACE | | SET "1" = MARK | |
|---|---------------|---|--------------|
| Q ₁ OFF | OUTPUT L = -6 | Q ₁ ON | OUTPUT L = 0 |
| Q ₂ ON | K = 0 | Q ₂ OFF | K = -6 |
| + PRIME ON H AND + TRIGGER ON F | | + PRIME ON J AND + TRIGGER ON E | |
| OR PERMANENT +1.5 PRIME (INTERNAL) AND + TRIGGER ON D | | OR PERMANENT +1.5 PRIME ON M AND + TRIGGER ON C | |

L = NORMAL OUTPUT
K = INVERTED OUTPUT

| VARIATIONS IN APPARATUS CODES CHART | | | | | |
|---|---------------|-----|-----|-----|-----|
| COMPONENTS OMITTED OR INCLUDED - OMIT X INCLUDE | | | | | |
| | CODE-TRSC | 500 | 600 | 700 | 800 |
| | LEVEL | 5 | 6 | 7 | 8 |
| A | EC359 & EC396 | - | - | - | X |
| B | EC359 & EC396 | - | - | X | X |
| C | EC359 & EC396 | - | X | X | X |

| | TYPE 1 | TYPE 2 | |
|----------|-----------------------|-------------------------------------|-------------------------------------|
| CODE-TRD | 603 | 804 | |
| BIT RATE | 1050 | 1050 | |
| LEVEL | 6 | 5 TO 8 | |
| A | EC 359 | X | |
| B | EC 359 | X | |
| C | EC 359 | X | |
| D | STRAPS | - | |
| E | STRAPS | X | |
| F | STRAPS | - | |
| G | START-STOP OSCILLATOR | EC394 0.95 M SEC | SAME |
| H | ADJUST TO | 2.9 M SEC +0.1 M SEC -0 M SEC | 950 U SEC +100 U SEC -0 U SEC |
| I | ADJUST TO | 475 U SEC | SAME |

Figure 7. Tape Receiver - Electronic Logic Diagram

TABLE L

Description and Logic Elements

| Symbol and Circuit No. | Function | Input | Output |
|---|--|--|---|
|  <p>FLIP-FLOP</p> | Acts as binary switch, frequency division, storage element, binary counter. | To "Set 0" lead -6 to 0 volt pulse or to step function OA or OB, prime input POB must be at ground or +1.5 volts, POA internally primed. To "Set 1" lead -6 to 0 volt pulse or square wave must be on OB or 1B input. Respective primes must be at ground or +1.5 volts to trigger output. | "Set 0" lead inverted output I must be at +0.8 volt. When switched to "Set 1" condition, square-wave output must be +0.8 to -6 volts. Conversely N (normal output) switches -6 to +0.8 volt in less than 5 microseconds. "Set 0" lead opposite above inputs. |
|  <p>ONE-SHOT, VARIABLE</p> | Generates a pulse of adjustable duration with fast rise times. Used for delay purposes. | SI input is a -6 to 0 volt pulse or square wave. Prime input, P1, must be at ground or 1.5 volts. | Inverted output I is at +0.8 to -6 volts for adjusted duration. N (normal output) is -6 to 0.8 volts for adjusted duration. |
|  <p>ONE-SHOT, FIXED</p> | Generates a pulse of fixed duration with fast rise times. Used for delay purposes. | Same as variable one-shot inputs. | Same as variable one-shot output except that duration of pulse is fixed. |
|  <p>VARIABLE PULSE DELAY</p> | Generates a pulse of variable duration depending on condition of biasing input. Used for delay purposes. | SI input is a -6 to 0 volt pulse or square wave. Prime input P1 must be at ground or +1.5 volts. Bias input B1 can be at -6 volts or ground. | Inverted output I goes from +0.8 to -6 volts for shortest duration when B1 input is at -6 volts and will time out its longest duration when B1 is at ground or slightly positive. Pulse duration may vary between shortest and longest duration depending on condition of B1. |

TABLE L (Continued)

Description and Logic Elements

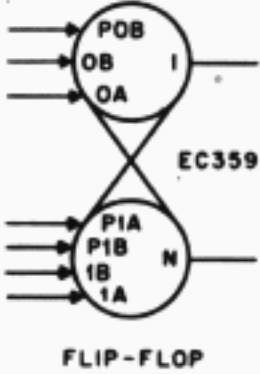
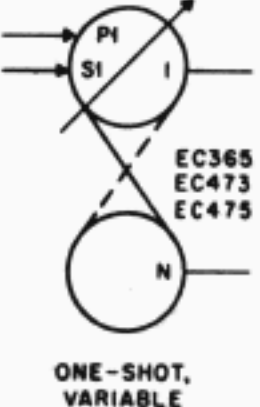
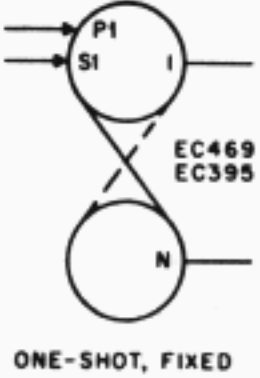
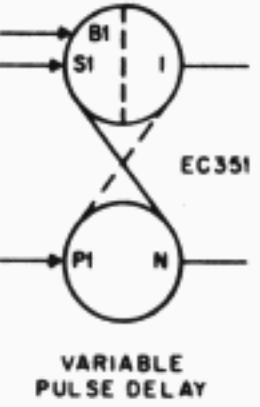

| Symbol and Circuit No. | Function | Input | Output |
|---|--|---|---|
|  <p>EC391 EC392 EC393 EC394</p> <p>START-STOP OSCILLATOR</p> | A sine wave oscillator of fixed audio frequency used to generate electronic clock which determines bit rate of system. | For ON condition input should be at ground or slightly positive. OFF condition input should be at -6 volts. | ON condition sine wave output is 1050 cps. Output swings from -1 volt to approximately -10 volts (8 to 9 volts peak to peak). In OFF condition, output is at steady state and about -5.5 volts. |
|  <p>EC420</p> <p>SQUARING AMPLIFIER</p> | Used in conjunction with start-stop oscillator. Shapes sine-wave input to positive pulses, one for each cycle of sine wave. Used as advance pulse generator (electronic clock pulses). | Sine wave -1 to -10 volts (8 to 9 volts pp). | Pulses are about 10 msec or less duration -6 to 0 volt, one pulse for each negative transition of sine wave. Steady state output at -6 volts. |
|  <p>EC347</p> <p>PULSE AMPLIFIER</p> | Reshapes square wave input to standard narrow pulse. Used as isolation amplifier. | Square wave input +0 to -6 volts transition. | Narrow pulse is -6 to 0 volt transition with a less than 5-msec rise time for duration of 10 msec or less. |
|  <p>EC401</p> <p>INVERTOR</p> | A dc-coupled amplifier used to invert input signal. | A -6 to 0 volt or 0 to +6 volts for each square wave or pulse input. | Same as input except that wave form is inverted. |
|  <p>EC375</p> <p>INHIBIT GATE</p> | Controls gating of signals. A presence of signal on one input inhibits output. | Square wave or pulse on either input. If B is at 0 volt, a negative signal on A will produce an output. | A pulse or square signal -6 to 0 volt for the duration of pulse. |
|  <p>EC321</p> <p>EMITTER FOLLOWER (PNP)</p> | An isolation amplifier used to drive diode gates will fast fall time output. | Square wave or pulse input -6 to 0 volt transitions. | Follows input -6 to 0 volt. |

TABLE L (Continued)

Description and Logic Elements



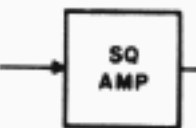
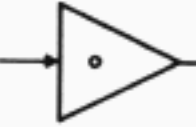
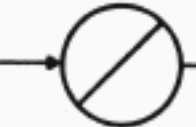
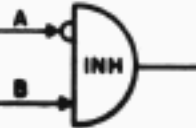



| Symbol and Circuit No. | Function | Input | Output |
|---|---|---|--|
|  <p>EMITTER FOLLOWER (NPN)</p> | An isolation amplifier used to drive gates with fast rise time output. | Square wave or pulse input -6 to 0 volt transitions. | Follows input -6 to 0 volt. |
|  <p>SYMMETRICAL EMITTER FOLLOWER</p> | Same as above. Provides isolation where output must have fast rise times for both positive and negative transitions. | Square wave or pulse input -6 to 0 volt transitions. | Follows input -6 to 0 volt. |
|  <p>"OR" GATE</p> | Used for gating two inputs. If signal appears on A or B, there will be a corresponding signal on the output lead. | Square wave or pulse input -6 to 0 volt. | Output is coincident with input -6 to 0 volt transition. Output will assume most positive value. |
|  <p>"AND" GATE</p> | Used for gating coincidence signals on A and B. | For an output both inputs A and B must be at 0 volt square wave or pulse input -6 to 0 volt. | Output a square wave or pulse input coincident with input. Output will assume most negative value. |
|  <p>MAGNETIC PULSER</p> | A regenerative amplifier used to drive selector magnets. A load consisting of coil and resistor is shunted by a diode output signal of adjustable duration. | To trigger circuit, prime input P1 must be at 0 volt or slightly positive and a -6 to 0 volt pulse or square wave must appear on S1. | -28 to 0 volt signal of adjustable duration between 3.5 msec to 7 msec. |
|  <p>SIGNAL IN AMPLIFIER</p> | Converts polar output of data set to neutral signals. | -3 to -25 volts for mark input, +3 to +25 volts for space input on A. At B input signal is blinded at -6 to 0 volt and unblinded at -6 volts. | Mark is approximately +1.5 volts and space is -6 volts. When B is at 0 volt, output is at 0 volt. |

TABLE L (Continued)

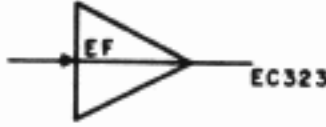
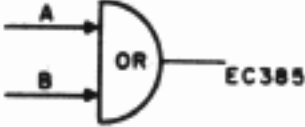
Description and Logic Elements

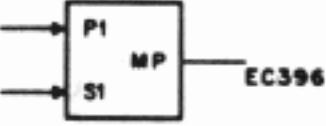
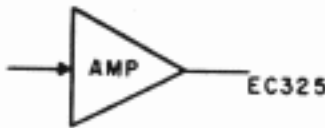
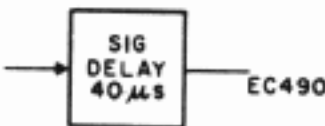
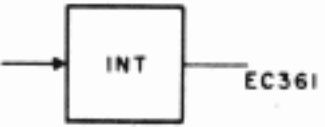
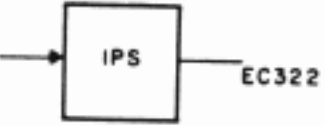
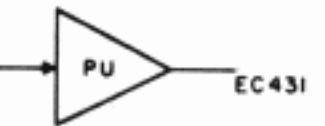
| Symbol and Circuit No. | Function | Input | Output |
|--|---|--|---|
|  <p>SIGNAL OUT AMPLIFIER EC325</p> | Converts a neutral signal to a polar signal capable of driving data set. | 0 volt for mark and -6 volts for space. | Polar signal output -6 volts for mark signal and +6 volts for space signal. |
|  <p>SIGNAL DELAY EC490</p> | Provides approximately 40-usec delay of signal input for gating purposes. | Signal input -6 to 0 volt transitions. | Same as input except delayed approximately 40 usec. |
|  <p>FILTER EC363</p> | Rejects high-frequency noise from voltage source. | To filter following voltage inputs in modules: +1.5, +6, -6, and -12 volts. | Same as input. High-frequency noise eliminated. |
|  <p>INTEGRATOR EC361</p> | Integrates input signal and prevents noise due to contact bounce. | Input signal of 0 to -28 volts. | Integrated output (slow rise time) 0 to -10 volts or less depending on input. |
|  <p>INTEGRATED PULSE SHAPER EC322</p> | Reshapes input signal so that output signal has fast rise time capable of driving standard circuit such as flip-flop. | 0 to -6 volts input of slow rise time. | -6 to 0 volt transition of 8 usec or less. |
|  <p>PICKUP AMPLIFIER EC431</p> | Converts pickup pulse generated by magnetic (sinusoidal signal) to a standard output signal. | Input is 40 volts pp around a -6 volt dc level. Minimum input 6 volts pp (-3 to -9 volts). Switches on positive transition of pickup signal. | Output is -6 to 0 volt transition for a duration of about 300 msec or less depending on speed and amplitude of input. |