

SYMBOLS FOR CIRCUIT SCHEMATIC DRAWINGS

CONTENTS	PAGE
1. GENERAL	1
2. SYMBOLS (General)	2
3. LOGIC SYMBOLS	77
4. LIGHTWAVE TRANSMISSION SYMBOLS	79
5. ALPHABETICAL INDEX	83

1. GENERAL

1.01 This section covers graphic symbols used in Bell System circuit drawings.

1.02 This section is reissued so that the contents could be rearranged and also to bring the symbols into agreement with the American National Standard "Graphic Symbols for Electrical and Electronics Diagrams." Since this reissue covers a general revision, arrows originally used to indicate changes have been omitted.

1.03 When new symbols are required for components not covered in this section, the matter shall be referred through normal lines of organization to Bell Telephone Laboratories, Incorporated, Holmdel, N. J. (Head, Standards Engineering—Dept. 8251).

(a) For other symbols considered to have no Bell System application, the American National Standard, "Graphic Symbols for Electrical and Electronics Diagrams," ANSI Y32.2 should be consulted.

(b) Cabling diagrams for schematic drawings shall conform with Section 800-610-153.

(c) Section 005-150-101 covers wiring symbols, wiring abbreviations, and definitions for wiring and cabling.

1.04 Symbols of components consisting of contacting elements are represented in two ways in this

section. Graphical representation using  or

 symbology for contacting elements is shown at

the left, and functional representation using  or

-symbology is shown at the right. The latter

representation came into practice with the introduction of the "Detached-Contact" method of circuit schematic representation. Numbers shown at symbol terminations are used in this section as an aid in correlating associated symbol parts.

1.05 The standard symbol for a terminal (O) may be added to each point of attachment of conductors to any one of the graphical symbols, but such added terminal symbols should not be considered as part of the individual graphical symbol itself.

1.06 Symbols in 2. SYMBOLS (General) of this section are shown full size, that is the same size used in the preparation of circuit drawings. Logic symbols are also shown full size but may be also shown on drawings to reduced sizes. Symbols will usually appear smaller on drawing copies in the field due to reduction from originals.

1.07 When space is insufficient to show information required to be entered within a symbol, the symbol may be enlarged provided the original distinctive shape is retained.

1.08 The orientation of a symbol on a drawing does not alter the meaning of the symbol. In most cases, component symbols may be rotated or shown as a mirror image in order to simplify the circuit layout. Exceptions to this general rule are made for symbols that require orientation in a definite position in order to identify the top, bottom, left, or right side of the component.

NOTICE

Not for use or disclosure outside the
Bell System except under written agreement

SECTION 005-108-111

2. SYMBOLS (General)

2.01 *Adjustability (variability)*: These recognition symbols shall be drawn at about 45 degrees across the body of the symbol to which they are applied.

Note: Use only if essential to indicate special property.

(a) Adjustability (extrinsic adjustability)

(1) General



(2) Preset, general



(See preceding note.)

(3) Linear [shown applied to paragraph 2.01(a) (1)].



(See preceding note.)

(4) Nonlinear [shown applied to paragraph 2.01(a) (1)].



(See preceding note.)

(b) Inherent variability (intrinsic variability)

(1) Linear



(See preceding note.)

(2) Nonlinear



(See preceding note.)

(c) Special features (shown applied to the general adjustability symbol)

(1) Continuous



(See preceding note.)

(2) In steps



(See preceding note.)

(d) Special features (shown applied to the general preset symbol)

(1) Continuous



(See preceding note.)

2.01 (Contd)

(2) In steps

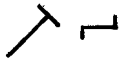

(See preceding note)

2.02 Alternator, Tone

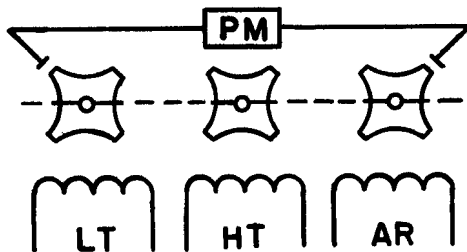

(DISCONTINUED)

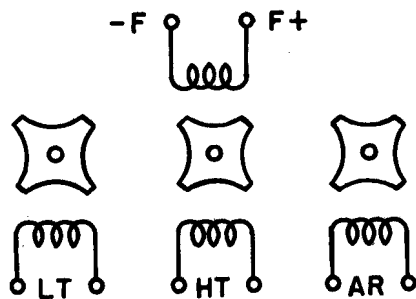

2.03 Amplifier

Note 1: The triangle is pointed in the direction of transmission.

Note 2: The symbol represents any method of amplification (electron tube, solid state device, magnetic device, etc).

Note 3: Amplifier use may be indicated in the triangle by words, standard abbreviations, or a letter combination.

(a) Single line

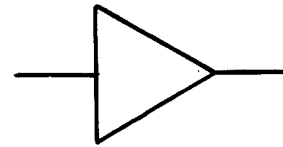

(b) When two outputs have to be shown

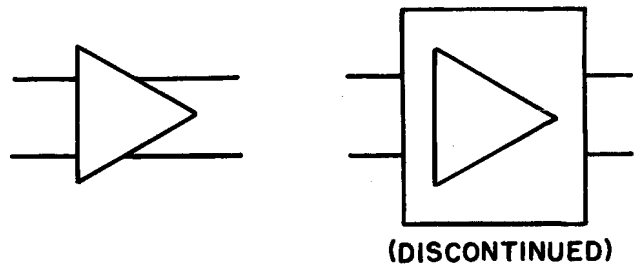

(c) Amplifier with adjustable gain (see preceding notes)



2.04 Antenna

(a) General

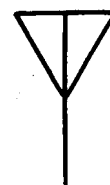

2.04 (Contd)

(c) Loop

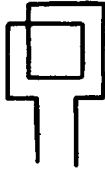

(b) Variable

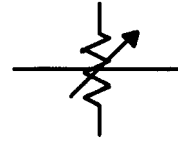

2.06 *Autotransformer* [see paragraph 2.92(k)]

2.07 *Battery and Potential Supply*

(d) Horn-type (microwave circuitry)

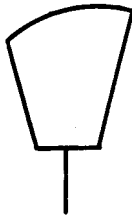

(a) One cell



(DISCONTINUED)

(e) Reflective type (microwave circuitry)
 Paraboloid spherical
 Parabolic cylinder,
 Parabolic torus, etc

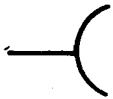

(b) Multicell battery (showing positive side grounded)

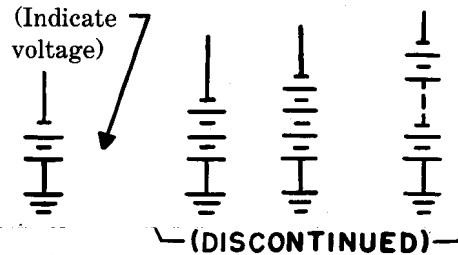

2.05 *Attenuator* (Microwave circuitry)

(a) Fixed



(c) CEMF cells

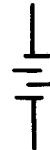

2.07 (Contd)

(d) Potential supply

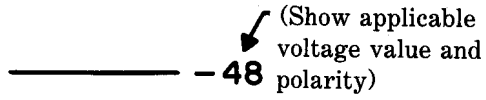

(e) Solar cell

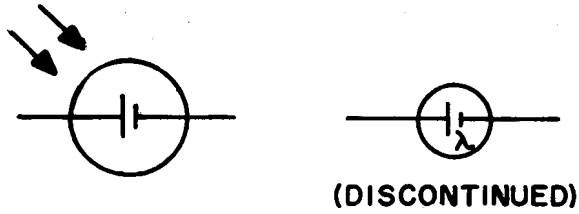

2.08 Bell (also see paragraph 2.70)

(a) AC bell

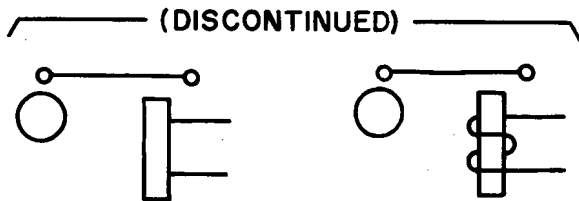

(b) DC bell

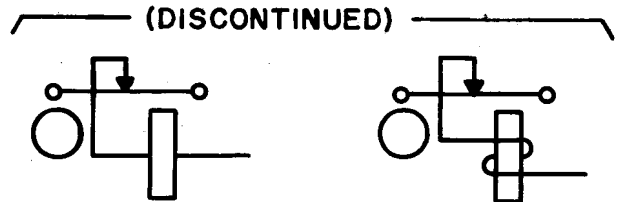

(c) AC-DC bell

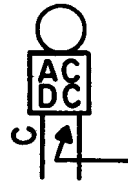

(Show D or A depending on whether DC or AC operation is intended)

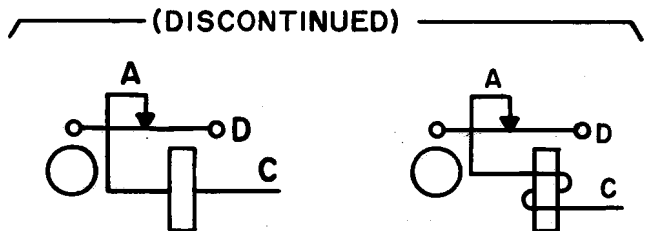

2.09 Breaker, Circuit

(a) General

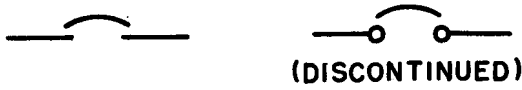

(1) Application

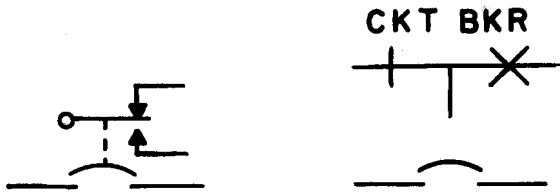

(DISCONTINUED)

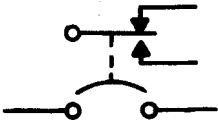

(b) Toggle switch type circuit breaker

Note: When this symbol is used, nontripped condition is shown.

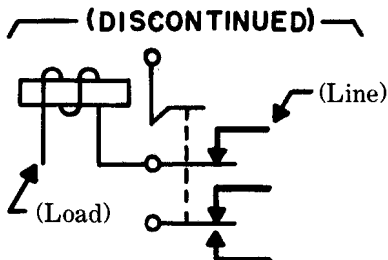
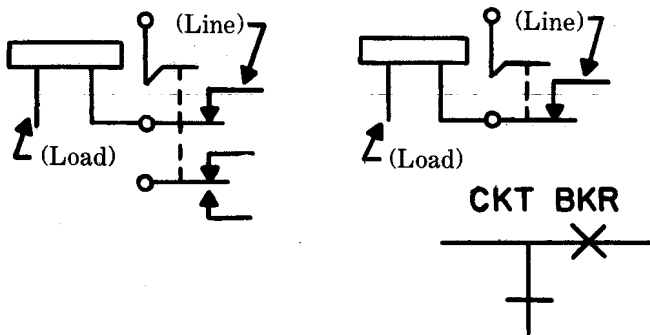

2.10 Buzzer

(a) AC buzzer



(b) DC buzzer



(c) AC-DC buzzer

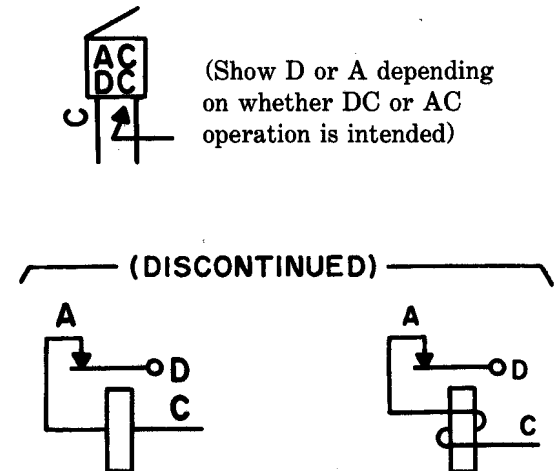

2.11 Capacitors

Note: The curved element represents the outside electrode in fixed-paper-dielectric and ceramic-dielectric capacitors, the negative electrode in polarized capacitors, and the moving element in adjustable capacitors.

- (a) Fixed capacitor (see preceding note)



- (b) Adjustable capacitor (see preceding note)

- (1) General



- (2) Preset

Note: If it is necessary to further identify trimmer capacitors, the letter T should appear adjacent to the symbol.



- (c) Differential adjustable capacitor (see note under paragraph 2.11)



- (d) Polarized (electrolytic) capacitor (see note under paragraph 2.11)

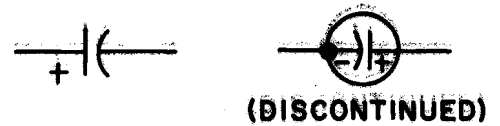

- (e) Feed-through capacitor (see note under paragraph 2.11)



2.12 Circuit Discontinuity



2.13 Circuit Element (General)



* Identify component or circuit entity by name

2.14 Circuit Return

- (a) Earth ground



2.14 (Contd)

(b) Chassis or frame connection

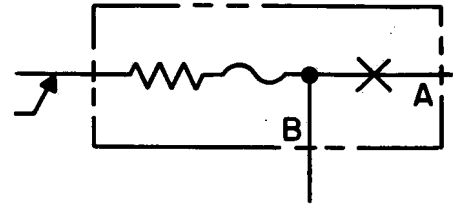
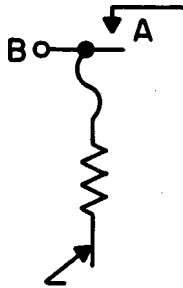

(c) Common connection

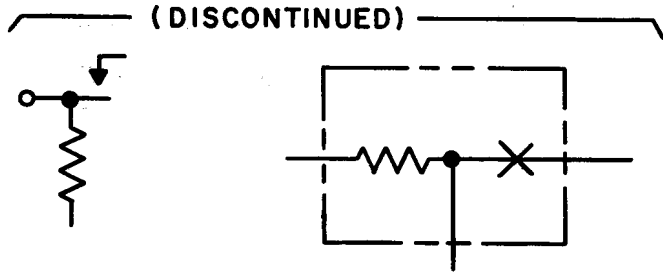

* Letters, numerals, or other identifying marks replace asterisk. This symbol is used to identify separate common connection paths within a circuit or any part thereof.

2.15 Clock, Electric (see instrument paragraph 2.38)

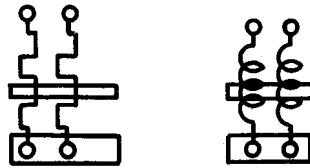

2.16 Coil (also see paragraphs 2.36, 2.37, and 2.93)

(a) Heat coil

(1) Alarm-type heat coil on bus bar. (See note below.)

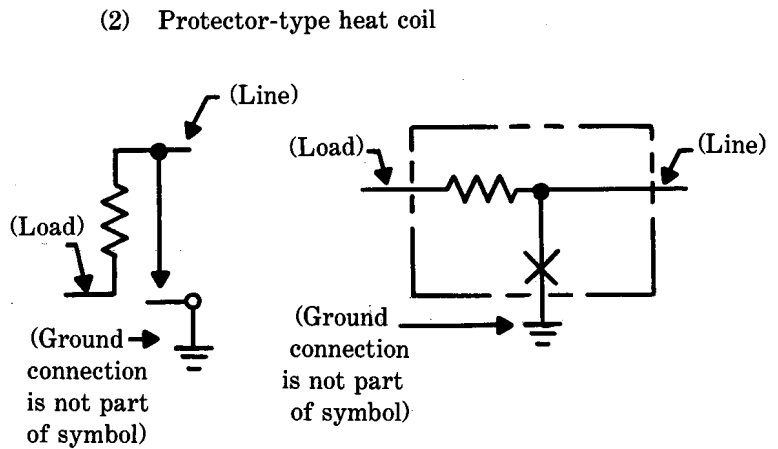

Note: When heat coil operates, alarm bus A is connected to power bus B. Letters are for explanation and are not part of the symbol.

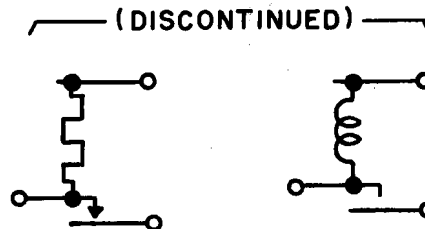

2.16 (Contd)

(b) Operating coil

- (1) Inductive winding for relays, electromagnets, etc

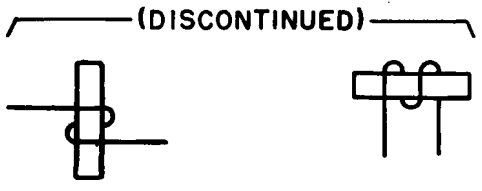
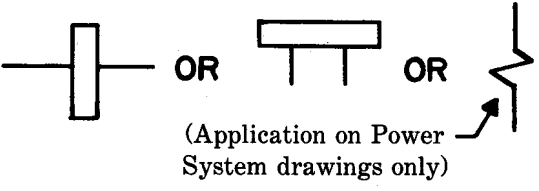

- (2) Inductive series windings internally connected.

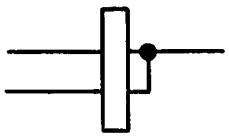

- (3) Noninductive winding

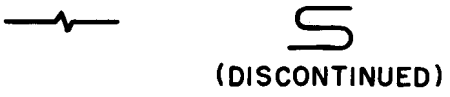

- (4) Inner end for windings of relay, electromagnets, etc (shown only on multiwound cores)

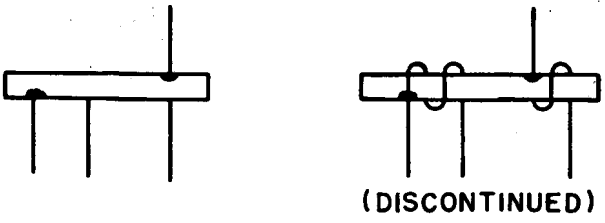

2.17 Connector

Note: Use appropriate number of contact symbols.

- (a) Female element

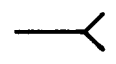

- (b) Male element

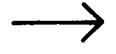

- (c) Hermaphroditic

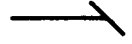

- (d) Separable connectors showing male and female elements engaged (see note above)



- (1) Connector associated with balanced-pair transmission line

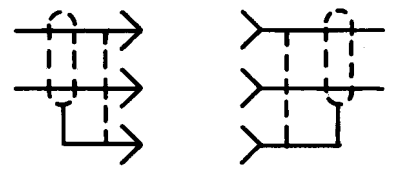

- (2) Twin connector associated with balanced-pair transmission line

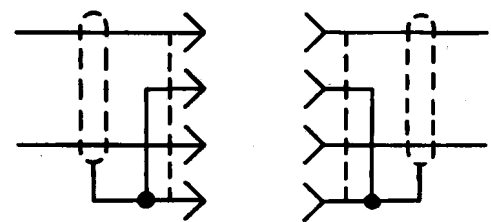

2.17 (Contd)

(e) Separable connectors showing hermaphroditic elements engaged



(1) Engaged multiple conductor connector showing individual hermaphroditic element designations when required

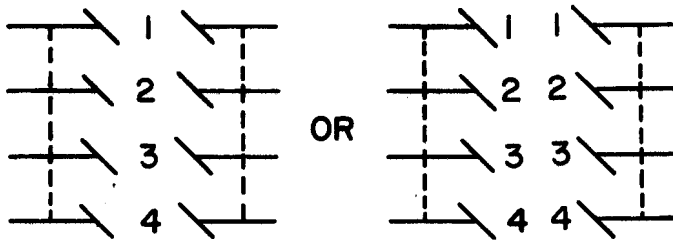

(Repeat numbers when mating elements are shown separated on the drawing)

(f) Coaxial connectors associated with coaxial transmission line

(1) Coaxial jack and plug for single line diagram



(2) Complete coaxial connectors

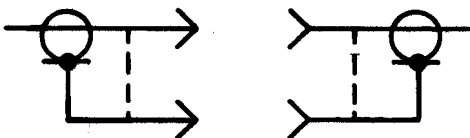

(3) Connector showing discontinuity symbol

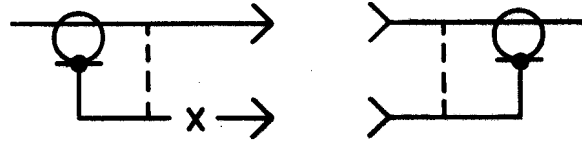

(DISCONTINUED)

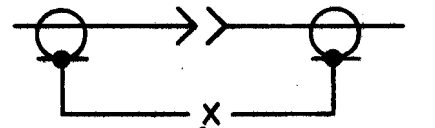

("X" signifies DC discontinuity)

(4) Coaxial cable connected to a single conductor with outside conductor terminated on chassis

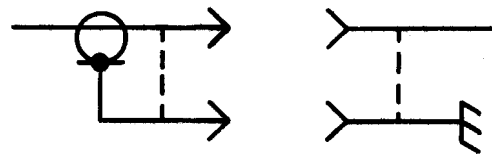

(g) Switchboard-type connectors (jacks and plugs)

Note: Symbol on the left is the preferred representation.

(1) 2-conductor jack

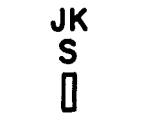

(DISCONTINUED)

2.17 (Contd)

(2) 2-conductor plug

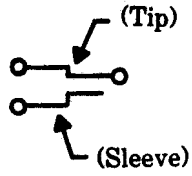

(3) 3-conductor jacks

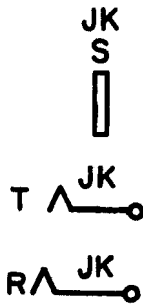
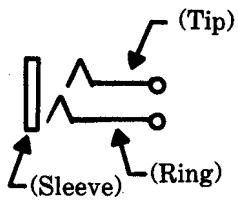

(DISCONTINUED)

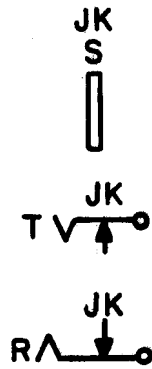
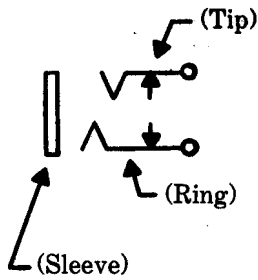

(DISCONTINUED)

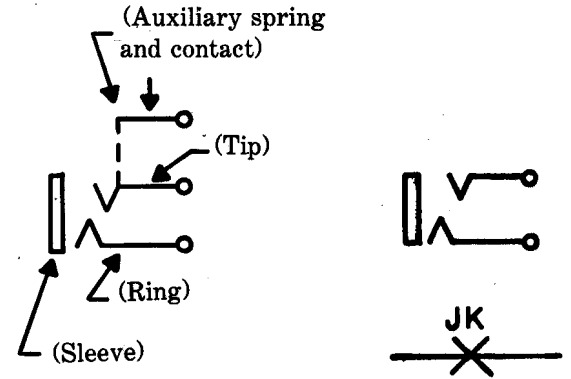

(4) 3-conductor plug

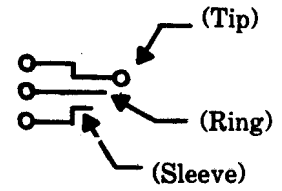

(5) Make-busy or shorting plugs



(6) Dummy plug

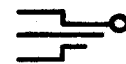

(7) Twin-type jacks

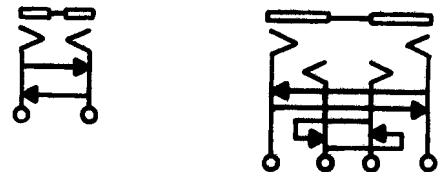

2.17 (Contd)

(8) Twin plug

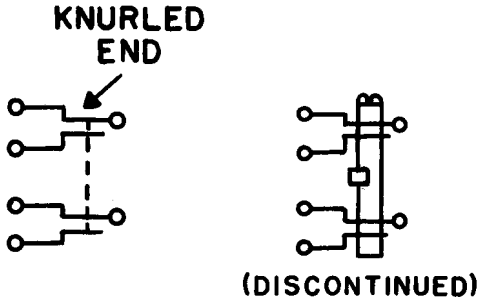

(9) Test-type jack

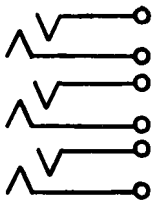

(10) Spring-Type jack and plug (engaged)

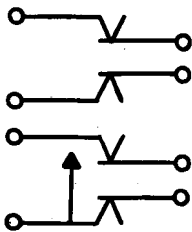

(11) Test plug

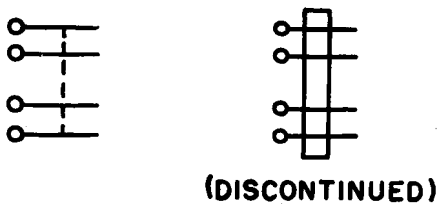

(12) 4-finger plug

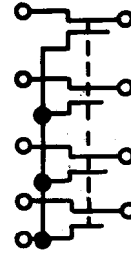

(h) Connectors commonly used for power supply (convenience outlets and mating connectors)

Note: The asterisk indicates that the terminal may be either nickel-plated, white metal, or copper-plated and represents the grounded side of the line. The specific type of terminal shall be indicated on the drawing.

(1) 2-conductor nonpolarized

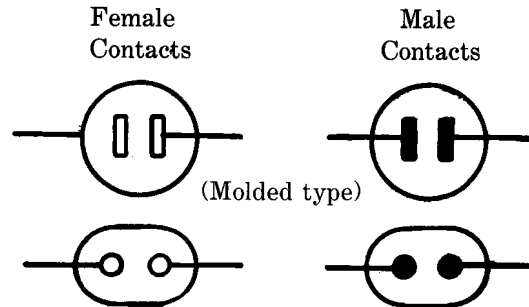

(2) 2-conductor polarized (see preceding note)

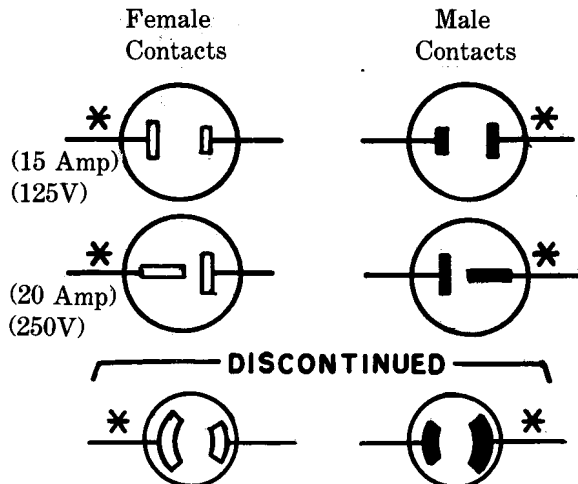

2.17 (Contd)

(3) 2-pole, 3-conductor, grounding type (see preceding note)

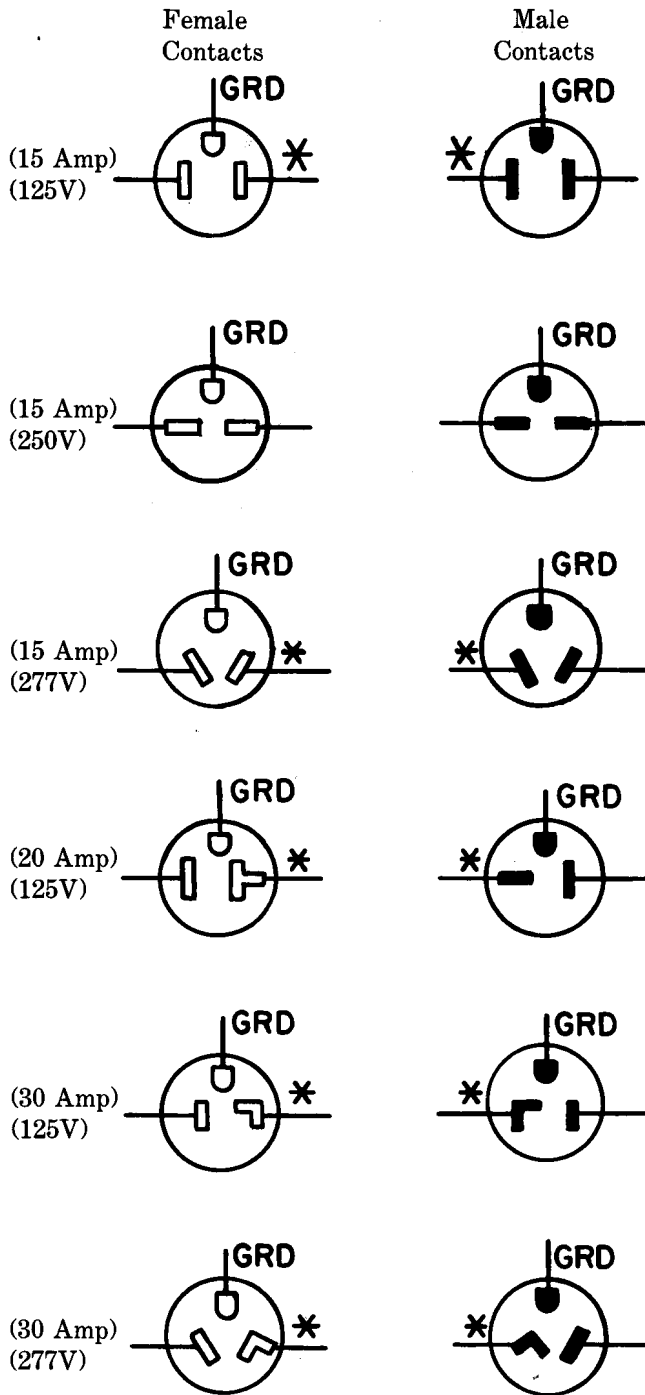

(4) 3-pole, 3-conductor (see preceding note)

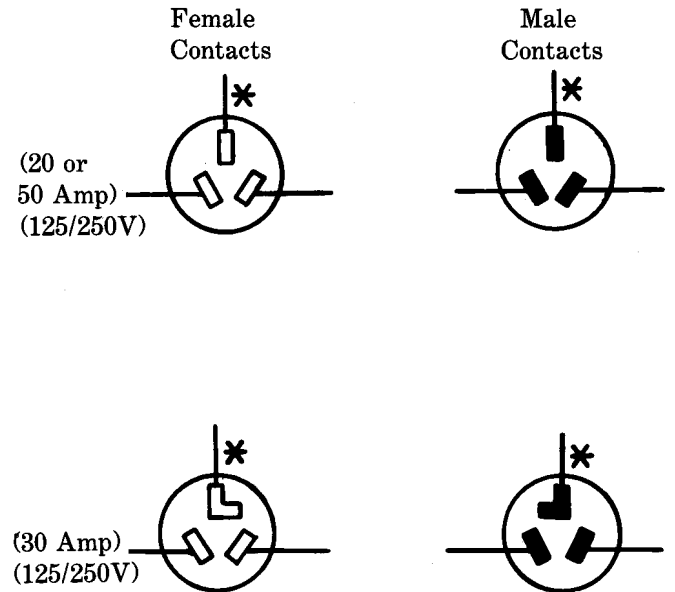

(5) 3-pole, 4-conductor, grounding (see preceding note)

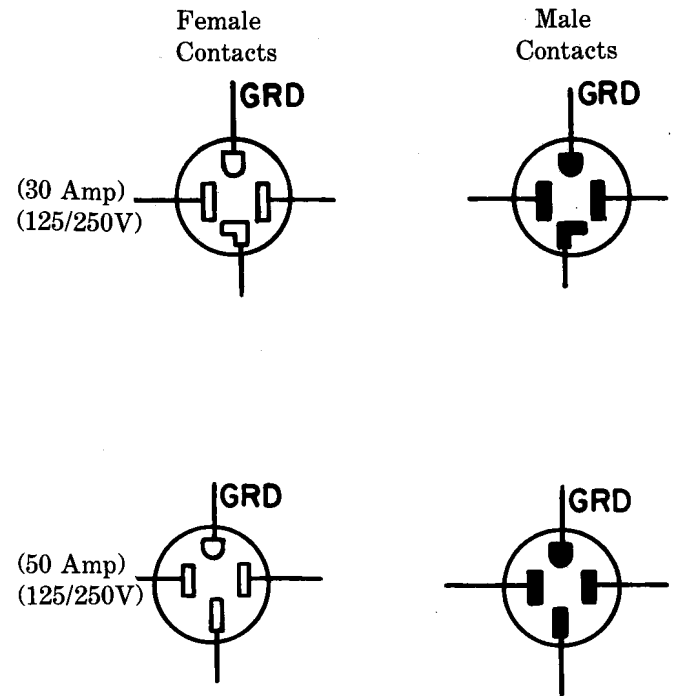

2.17 (Contd)

(6) 4-pole, 4-conductor

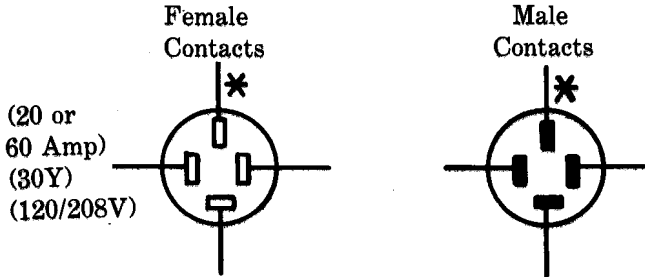

(i) Cord tip-type connector

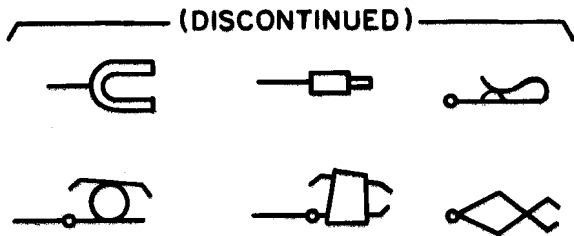
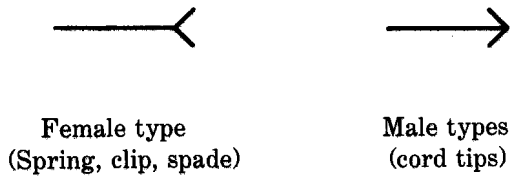

2.18 Contact

(a) Fixed

(1) Adjustable, indirectly actuated, or sliding

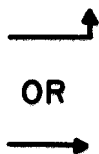

(2) Switch



(3) Toggle switch (momentary)



(b) Moving

(1) Nonlocking (relays, keys, jacks, etc)

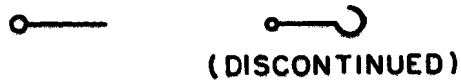

(2) Locking (keys and jacks)

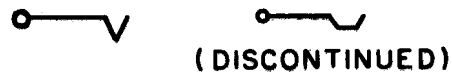

(3) Rotating contact (slip ring) and brush



(4) Vibrator reed



2.18 (Contd)

(5) Vibrator split reed



(c) Break- and make-contacts

(1) Break-contact (graphical representation)

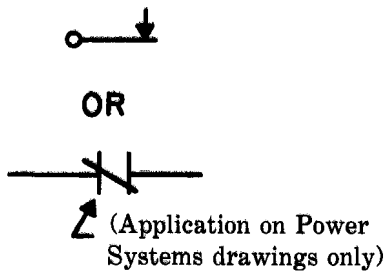

(2) Make-contact — graphical representation

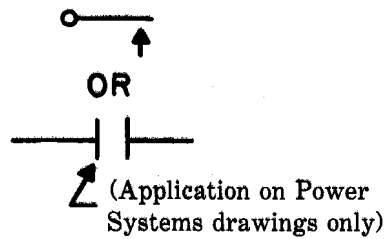

(3) Transfer — graphical representation

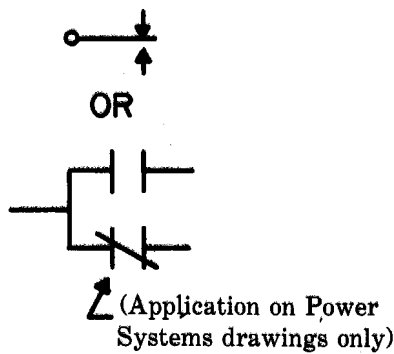

(4) Break-contact — functional representation (closed when not actuated)



(5) Make-contact — functional representation (open when not actuated)



(6) Transfer — functional representation

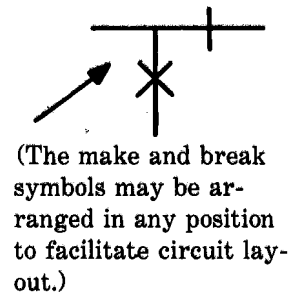

2.19 Contactor

(a) Relay (armature-type)

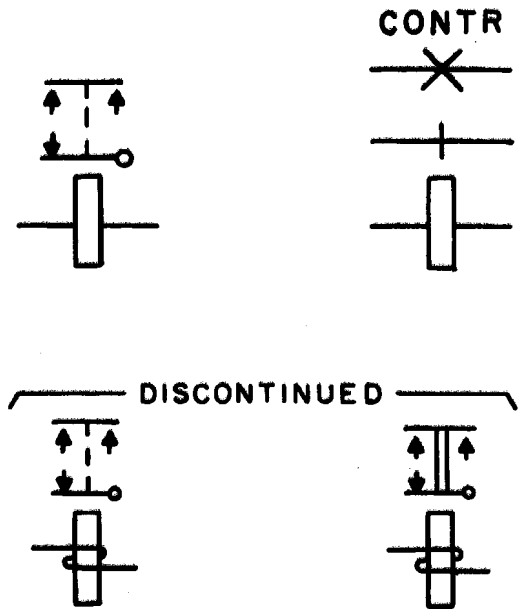

2.19 (Contd)

(b) Solenoid-type



DISCONTINUED

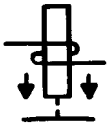

(c) Application on Power Systems drawings

(1) Manually operated 3-pole contactor

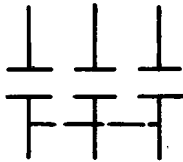

(2) Electrically operated one-pole contactor with series blowout coil

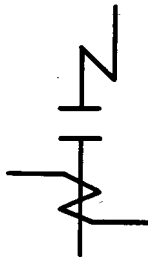

(3) Electrically operated 3-pole contactor with series blowout coils; 2 open and 1 closed auxiliary contacts (shown smaller than main contacts)

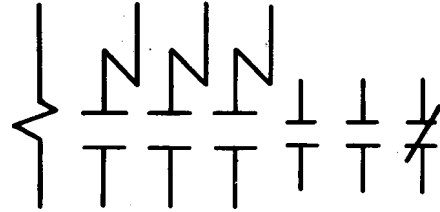

(4) Electrically operated one-pole contactor with shunt blowout coil

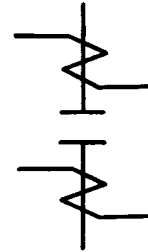

2.20 Core

(a) Magnetic (general)



(b) For relays, magnets, etc

(see also permanent magnet)



2.20 (Contd)

(c) Relay core with frame ground

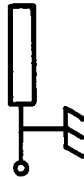

(d) Magnetic core switching element (mirror symbol)

Note: ϕ = Magnetization
 i = Current
 e = Electromotive force
 ϕ , i , e , and directional arrows are not part of the symbol.

(Mirror symbol represents each core winding and aids in correlating direction of magnetization and induced voltage)

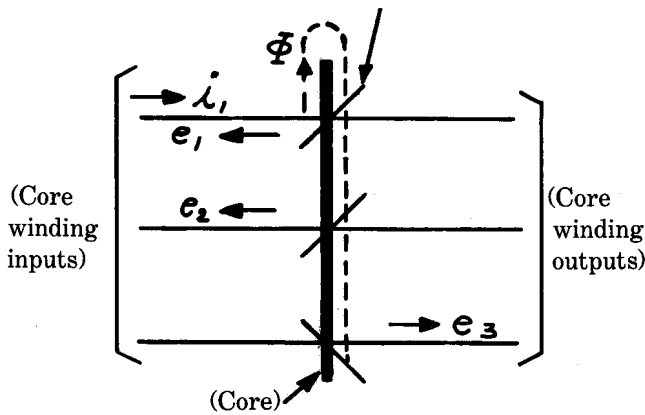

2.21 Coupler, Directional (microwave circuitry)

(a) General



- (1) Arrows indicate direction of power flow.
- (2) Number of coupling paths may be indicated.
- (3) Transmission loss may be indicated.

(b) E-plane aperture coupling, 30-dB attenuation
 [see also paragraph 2.21(b) on coupling apertures]



(c) Loop coupling, 30-dB attenuation



(d) Probe coupling, 30-dB attenuation

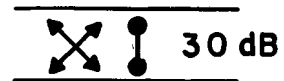

(e) Resistance coupling, 30-dB attenuation

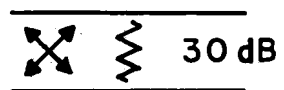

2.22 Coupling (microwave circuitry)

(a) Coupling by loop

(1) Coupling by loop to space



2.22 (Contd)

- (2) Coupling by loop to guided transmission path



- (3) **Application:** Coupling by loop from coaxial to circular waveguide

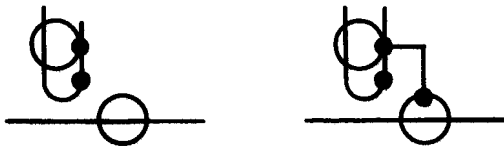

(DISCONTINUED)

- (b) Coupling by aperture with an opening of less than full waveguide size

- (1) Designate E, H, or HE

E indicates that the physical plane of the aperture is perpendicular to the transverse component of the major E lines.

H indicates that the physical plane of the aperture is parallel to the transverse component of the major E lines.

HE indicates coupling by all other kinds of apertures.

Transmission loss may also be indicated.

- (2) Coupling by aperture to space



- (3) Two ends of transmission path available

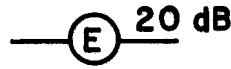

- (4) Three ends of transmission path available

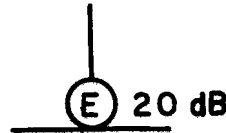

- (5) Four ends of transmission path available



- (c) Coupling by probe (see paragraph 2.54)

- (1) Coupling by probe to space



- (2) Coupling by probe to a guided transmission path



- (3) **Application:** Coupling by probe from coaxial to rectangular waveguide



(DISCONTINUED)

2.23 Delay Function (slow-wave structure)

Note: Length of delay may be indicated. Asterisk is not part of symbol. If identification, electrical values, location data, and similar information must be noted when a symbol, the size or the proportion of the original symbol may be altered providing its distinctive shape is retained. End with two vertical lines indicates input side.

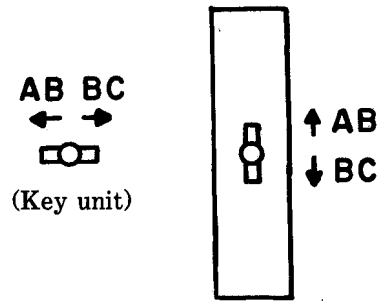

(a) General



* See preceding note

(b) Tapped delay function

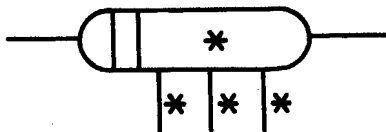

* See preceding note

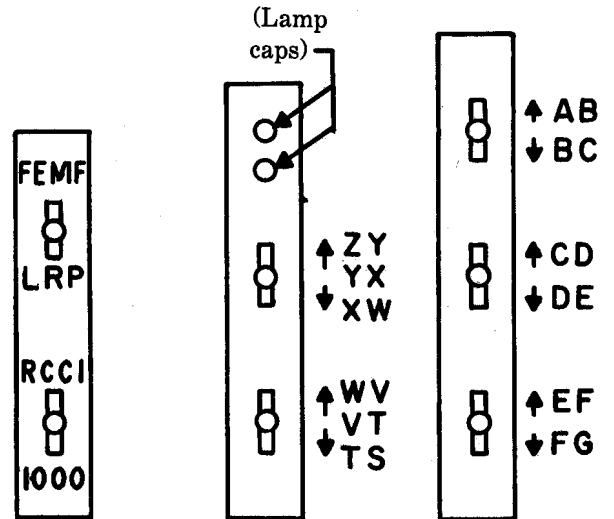

(b) Turnbutton-type keytop diagrams

2.24 Diagram, Keytop

Note: Show designations within keytops only when engraved.

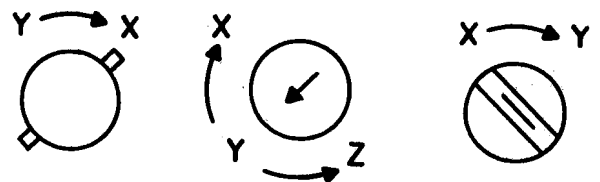

(a) Lever-type keytop diagrams (see note above)

(c) Switch top diagram [see paragraph 2.83(p)]

2.24 (Contd)

(d) Pushbutton-type keytop diagrams (see note under paragraph 2.23)

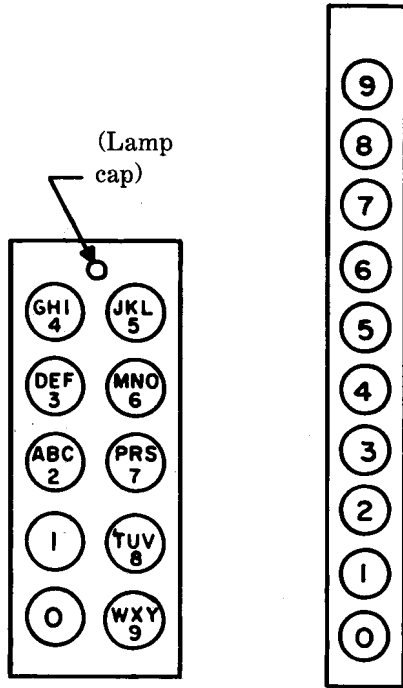

2.25 Dial [see also paragraph 2.83(n)]

Note: Colors shall be shown as required.

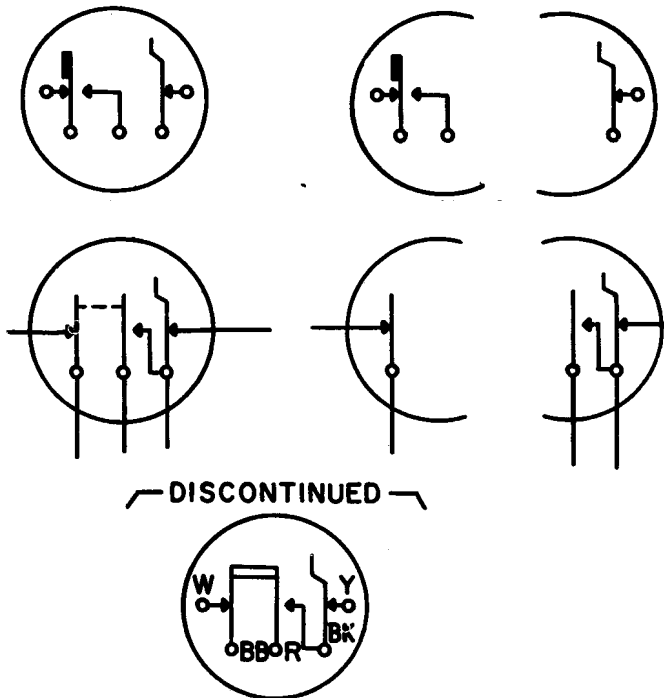

2.26 Direction of flow of power, signal, or information

(a) One-way



(b) Both ways



2.27 Discontinuity (microwave circuitry)

(a) To be drawn for a component that exhibits the properties of one of the types of circuit elements throughout the frequency range of interest.

(b) Equivalent series element—General

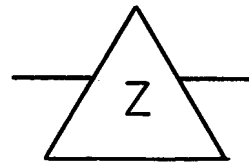

(1) Capacitive reactance

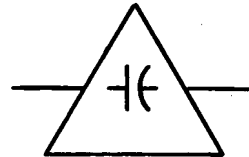

(2) Inductive reactance

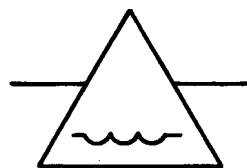

2.27 (Contd)

- (3) Inductance-capacitance circuit with infinite reactance at resonance

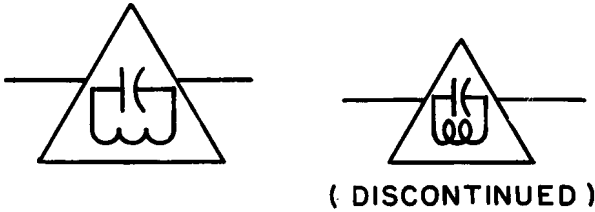

- (4) Inductance-capacitance circuit with zero reactance at resonance

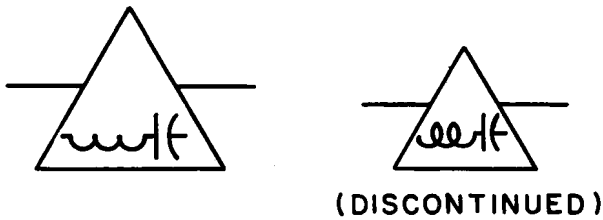

- (5) Resistance

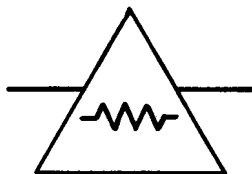

- (c) Equivalent shunt element—general

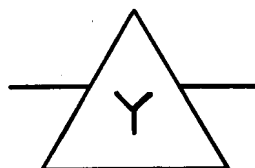

- (1) Capacitive susceptance

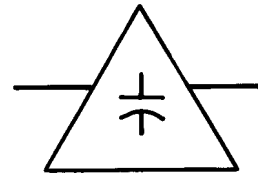

- (2) Conductance

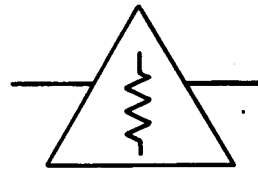

- (3) Inductive susceptance

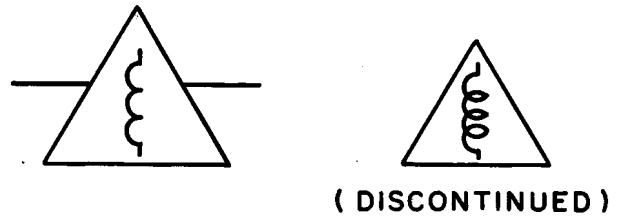

- (4) Inductance-capacitance circuit with infinite susceptance at resonance

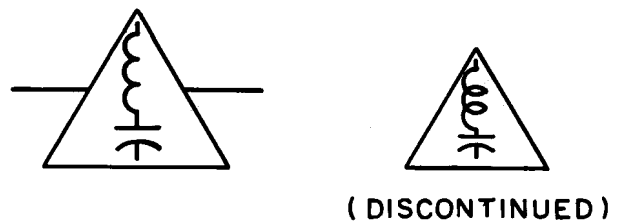

- (5) Inductance-capacitance circuit with zero susceptance at resonance

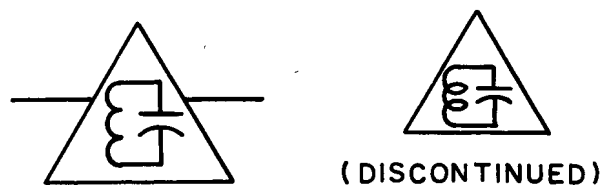

2.28 Drop

(a) Manually restored drop

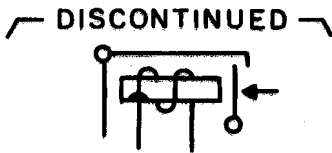

(b) Electrically restored drop

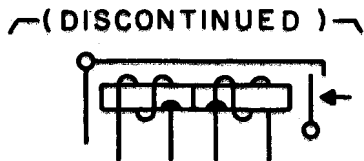
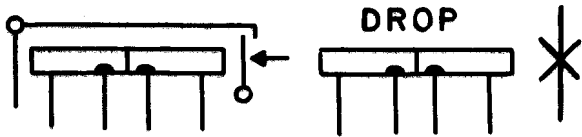

2.29 Electromagnet

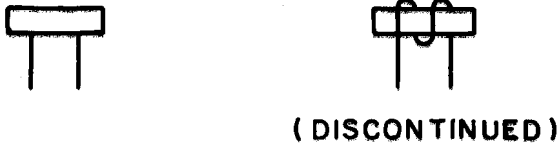

2.30 Fork, Tuning

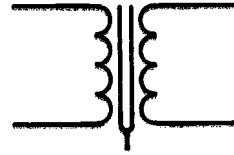

2.31 Fuse

Note: When fuse blows, alarm bus A is connected to power bus B. Letters are not part of the symbol.

(a) Fuse (no alarm)



(b) Alarm-type fuse

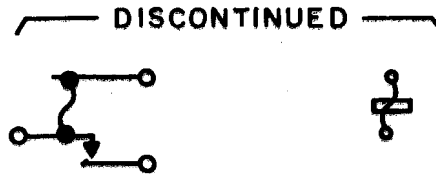
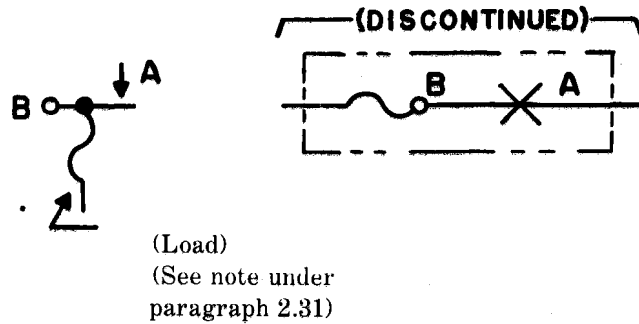

2.31 (Contd)

(c) Alarm-type fuse on bus bar

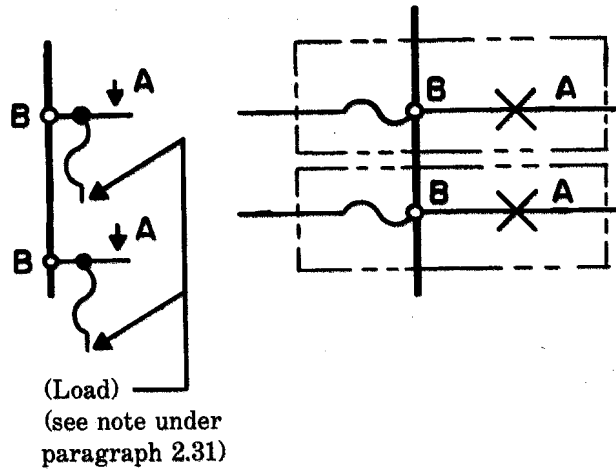
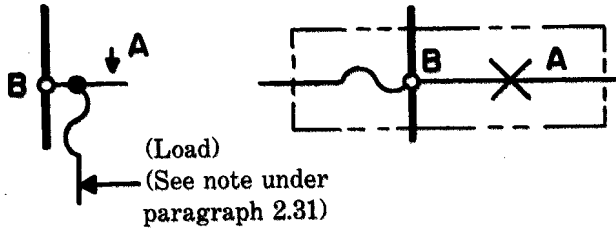

(DISCONTINUED)



(d) Fuse in safety-type holder



2.32 Gap (lightning arrester)

(a) General



(b) Carbon block (protector)

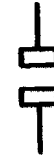

(c) Carbon block (Protector) with ground

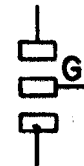

2.33 Handsets

(a) 3-conductor handset

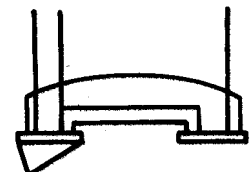
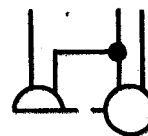

(DISCONTINUED)

(b) 4-conductor handset

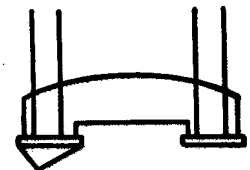
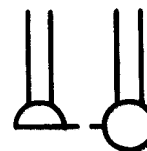

(DISCONTINUED)

2.33 (Contd)

(c) 4-conductor handset with push-to-talk switch

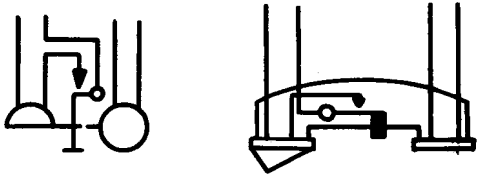

(DISCONTINUED)

2.34 Headset, Operator (also see paragraph 2.62)



2.35 Horn or Howler (see paragraph 2.46)

2.36 Inductance (repeating coil, inductor, transformer, etc)



(DISCONTINUED)

2.37 Inductor (coil)

(a) General

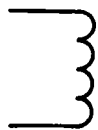

(b) When necessary to show magnetic core



(c) With taps



(d) Adjustable

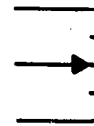

(e) Continuously adjustable



(f) Shunt

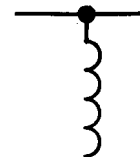

(g) Saturable reactor

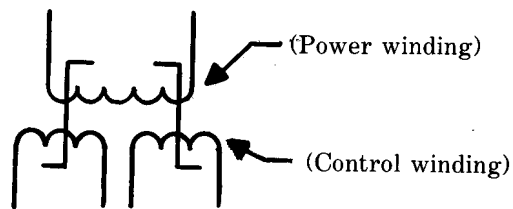

(DISCONTINUED)

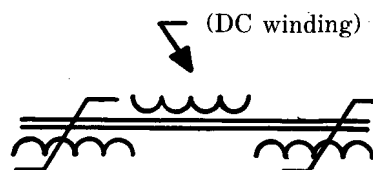

(DISCONTINUED)

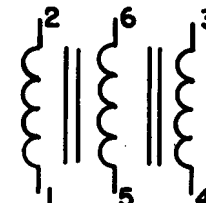

2.38 Instrument (meters)

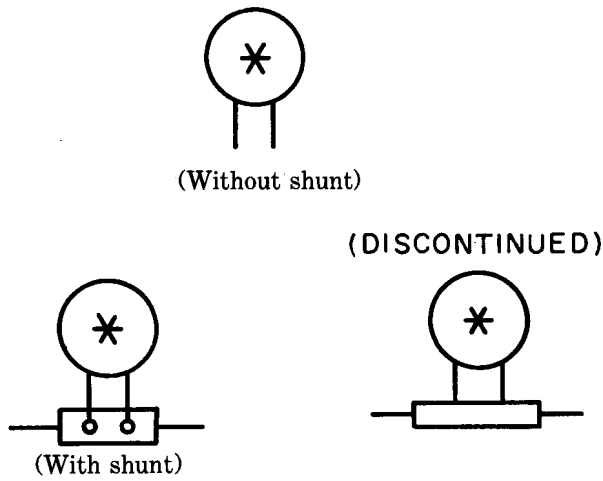

* Show abbreviations to identify the specific type of instrument or meter. For example:

- A - Ammeter
- AH - Ampere-hour
- C - Clock
- DB - Decibel
- F - Frequency
- G - Galvanometer
- MA - Milliammeter
- PF - Power factor
- TT - Total time
- UA - Microammeter
- V - Voltmeter
- VA - Volt-ammeter
- VO - Volt-ohm
- VOM - Volt-ohm-milliammeter
- VU - Volume unit
- W - Watt
- WH - Watt-hour

2.39 Interrupter

(a) Motor-driven type

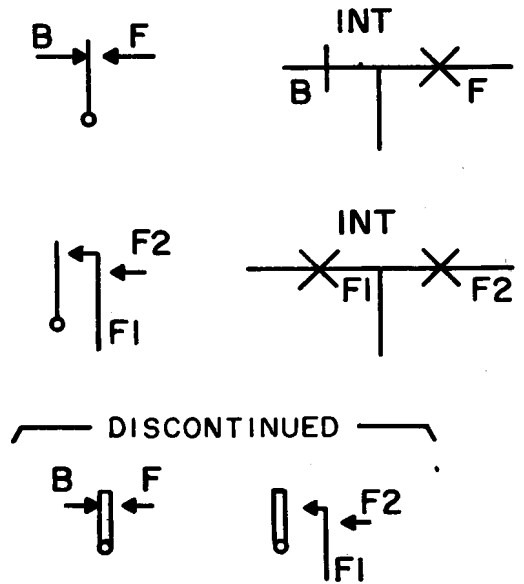

(b) Ringing interrupter

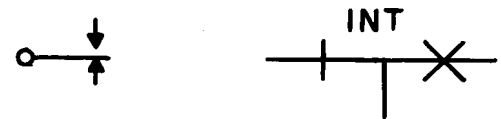

2.40 Isolator (microwave circuitry)

Note: Power flowing in direction of arrow is not intentionally attenuated.

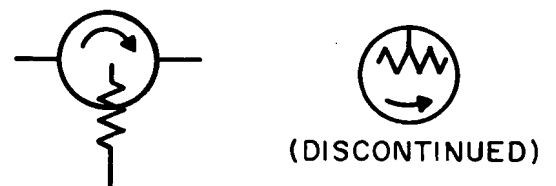

2.41 Jack [see paragraph 2.16(g)]

2.42 Junction

(a) Hybrid (general)

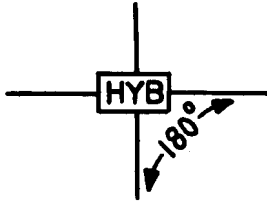

(b) Tee or wye
(coaxial and waveguide transmission)



(c) Hybrid, junction
(coaxial and waveguide transmission)

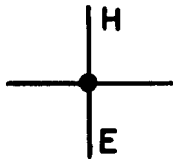

(d) Application: Waveguide and coaxial couplings

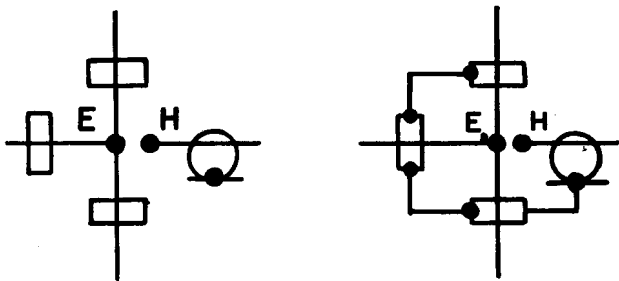

(DISCONTINUED)

(e) Hybrid, circular (basic)

Note: The asterisk is not a part of the symbol. Always replace the asterisk by E, H, or HE. E indicates that there is a principal E transverse field in the plane of the ring. H indicates that there is a principal H transverse field in the plane of the ring. HE shall be used for all other cases. An arm with coupling other than shown in ring shall be indicated on the arm. Critical distances should be labeled in terms of guide wavelengths. See paragraph 2.42(d)(1).

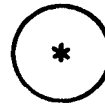

(1) Application: 5-arm circular hybrid with principal coupling in the E plane and with one-arm H coupling using rectangular waveguide.

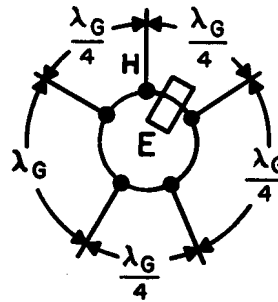

(f) Circulator, fixed direction

Note: Arrowhead indicates direction of power flow from any input to next adjacent arm but not to any other arm. Circulator may have three or more ports.

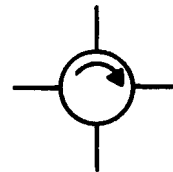

2.42 (Contd)

(1) Application: Circulator, reversible direction. The polarity symbol must be used with the electromagnet symbol to indicate proper direction flow.

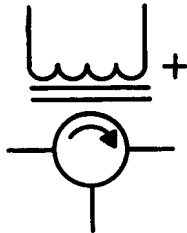

2.43 Key

Note: Reference letters in parentheses (A), (B), (C), and (D) are used to identify each quadrant of the lever-type key symbol. Quadrant letter identifications are assigned in a clockwise direction when the key is viewed from the wiring side. Contacts and springs in the A and D quadrants are actuated when the key lever is operated toward that part of the key which is designated "front" for orientation purposes. Front and code marking side correspond in lever-type keys.

(a) Locking lever-type (see note under paragraph 2.43)

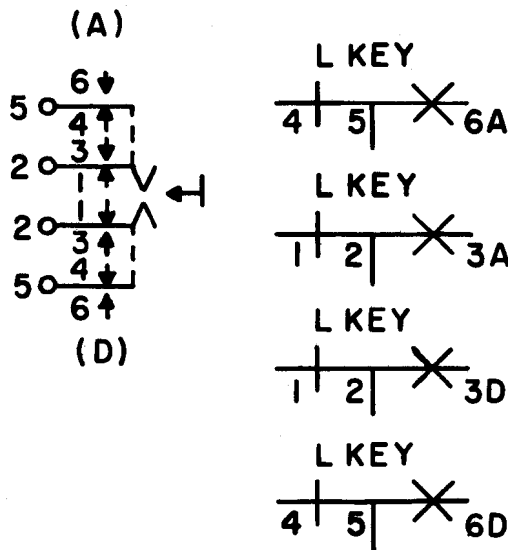

(a) Locking lever-type (Continued)

(DISCONTINUED)

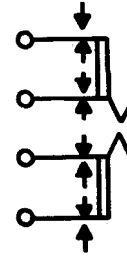

(b) Nonlocking lever-type (see note under paragraph 2.43)

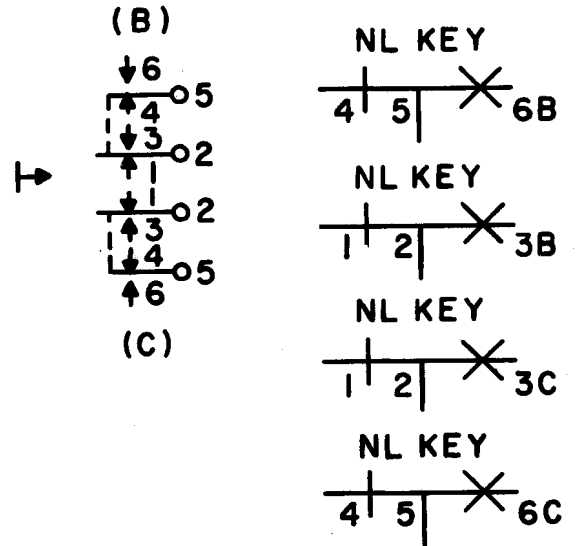

(DISCONTINUED)

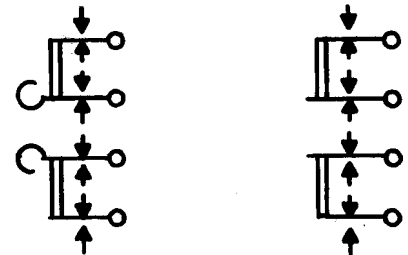

2.43 (Contd)

(c) Both halves of key actuated with single throw of lever (see note under paragraph 2.43)

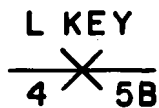
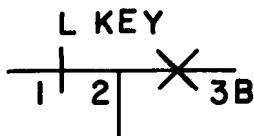
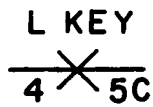
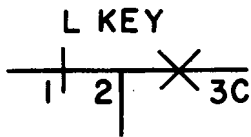
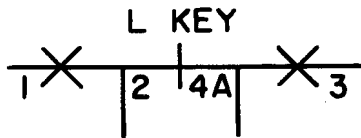
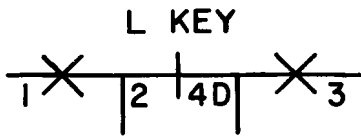
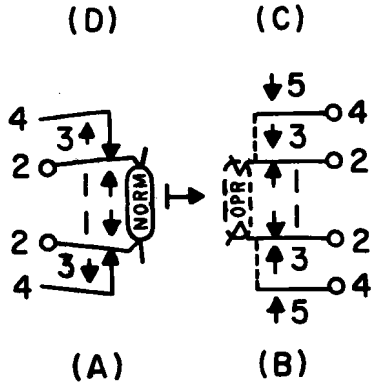

~(DISCONTINUED)~

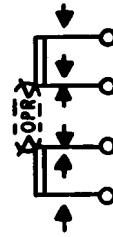

(d) Jack-type

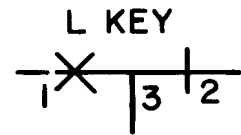
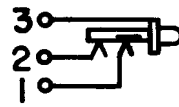

(e) Plunger-type

(1) Nonlocking

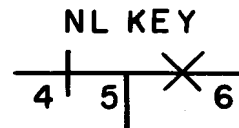
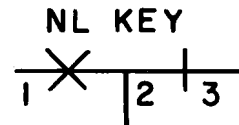
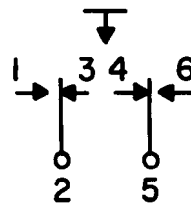

~(DISCONTINUED)~

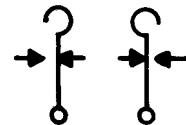

2.43 (Contd)

(2) Locking

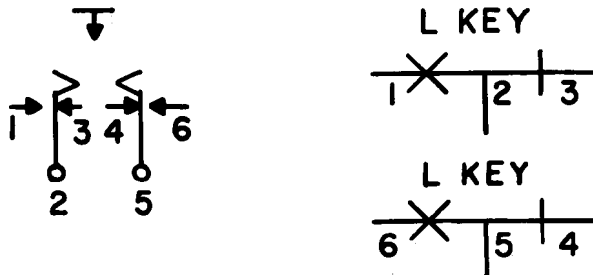

—(DISCONTINUED)—

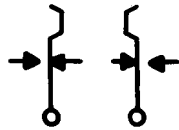

(3) Locking (push to operate, push to release) also provision for lamp

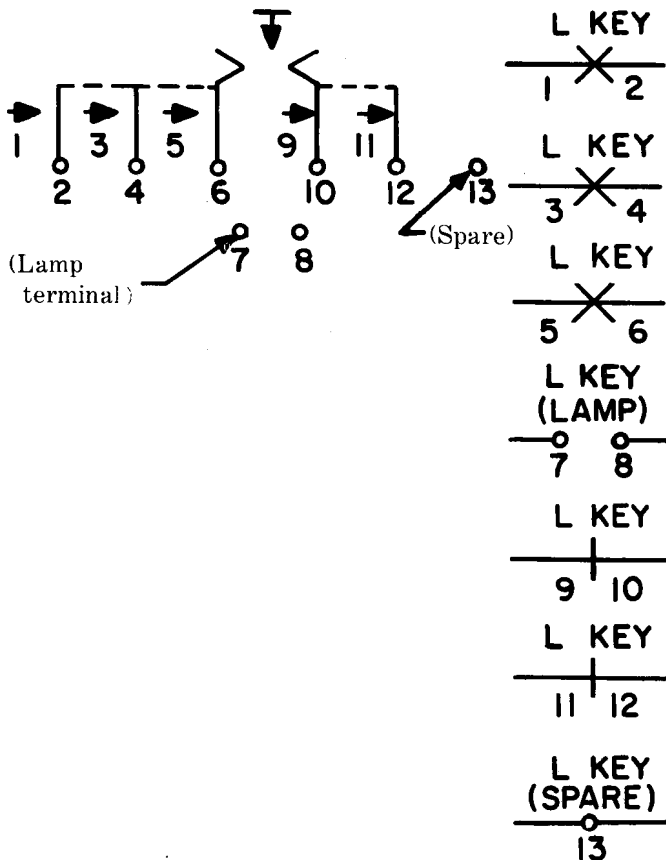

(f) Turnbutton type

(1) One direction

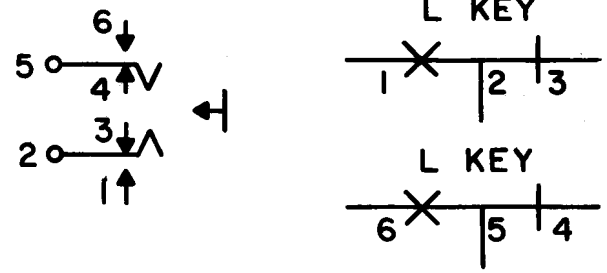

(2) Two direction

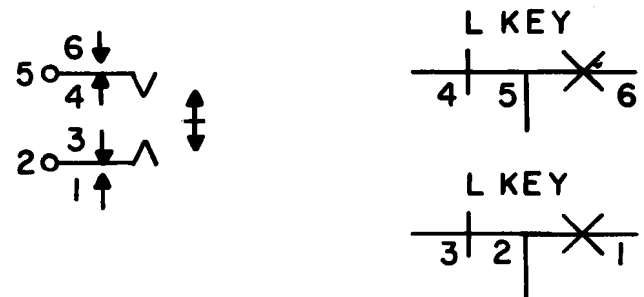

(g) Plunger—turnbutton type

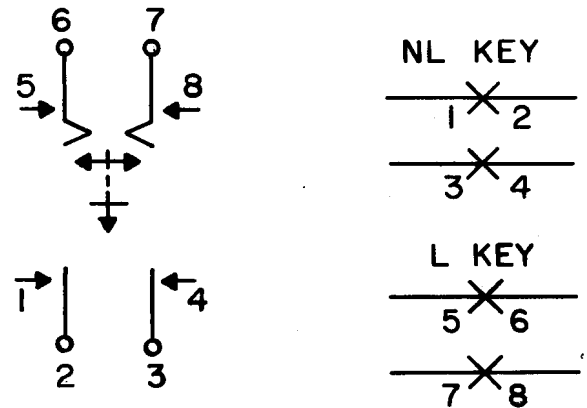

(h) Telegraph-type



2.43 (Contd)

(i) Selector-type

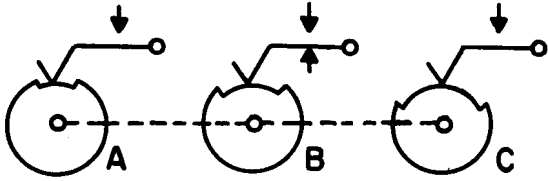

2.44 Keytop Diagram (see paragraph 2.23)

2.45 Lamp

(a) Single-filament ballast or resistance

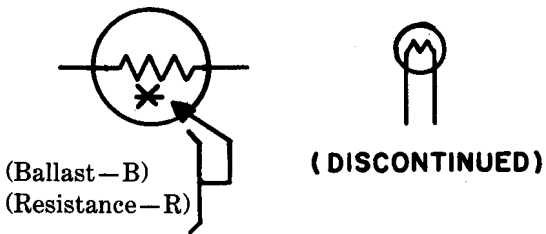

(b) Double-filament ballast or resistance

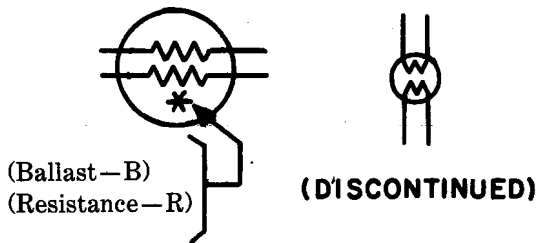

(c) Illuminating-type

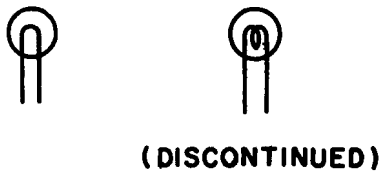

(d) Switchboard-type



(e) Glow-type

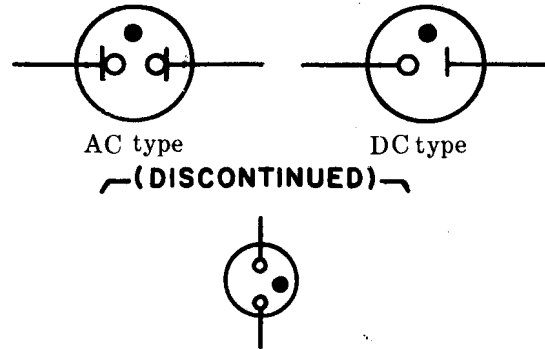

2.46 Loudspeaker, Horn, Howler, Telephone Receiver (tone ringer)

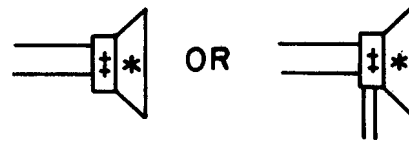

(See following note)

(DISCONTINUED)

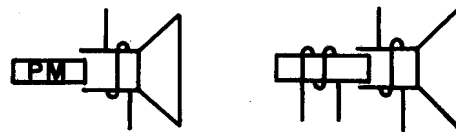

Note: If specific identification of loudspeaker parts is required, the following letter combinations may be added. The * and ‡ are not part of the symbol.

2.46 (Contd)

- ‡ EM —Electromagnetic with moving coil (moving coil leads should be identified)
- ‡ EMN —Electromagnetic with moving coil and neutralizing winding (moving coil leads should be identified)
- * HN —Horn
- * HW —Howler
- * LS —Loudspeaker
- ‡ MG —Magnetic armature
- ‡ PM —Permanent magnet with moving coil
- * TR —Telephone receiver (tone-ringer)

2.47 Machine, Rotating

- (a) Generator (general)



- (b) Motor (general)



- (c) Winding symbols

- (1) One-phase



- (2) 3-phase wye (grounded)



- (d) Separately excited direct-current generator or motor

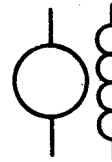

(DISCONTINUED)

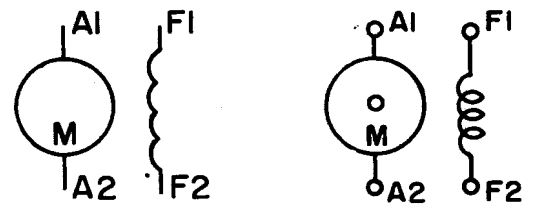

- (e) Separately excited direct-current generator or motor; with commutating or compensating field winding or both



- (f) Direct-current series motor or 2-wire generator

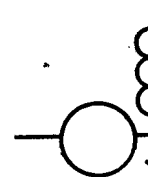

2.47 (Contd)

(g) Direct-current shunt motor or 2-wire generator; with commutating or compensating field winding or both

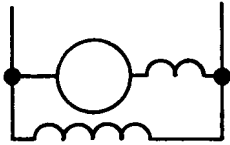

(h) Direct-current compound motor or 2-wire generator or stabilized shunt motor

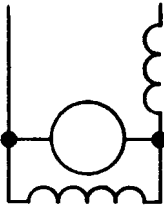

(i) Squirrel-cage induction motor or generator, split-phase induction motor or generator, or repulsion motor



(DISCONTINUED)

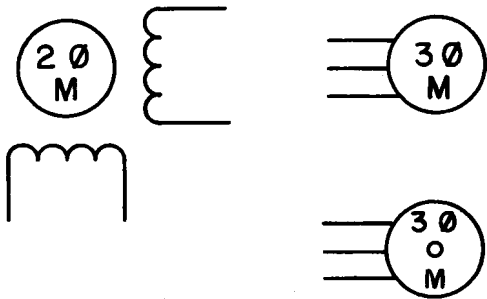

(j) Synchronous motor or generator with neutral brought out



(k) Synchronous motor or generator with both ends of each phase brought out



(l) Hand-type generator

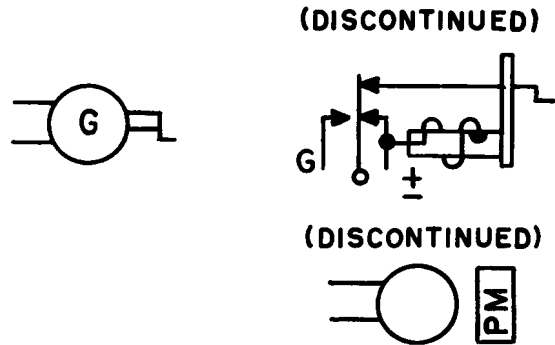

2.48 Magnetic Clutch

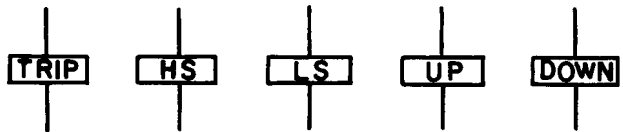

HS—High speed
LS—Low speed

2.49 *Meters* (see paragraph 2.38)

2.50 *Microphone*



2.51 *Motion*

(a) Translation, one direction



(b) Translation, both directions



(c) Rotation, one direction



(d) Rotation, both directions



2.52 *Motors* (see paragraph 2.47)

2.53 *Network*

(a) Typical network

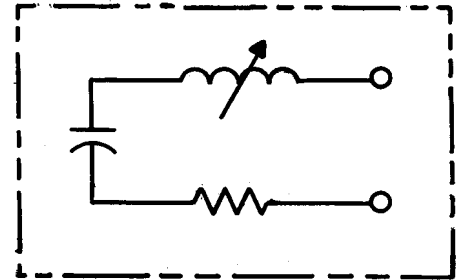

(b) Networks used as contact protection

Note: A number, starting with 1, is assigned for each different coded network used in the circuit. The same number is used for each network of the same code used in the circuit. No number is used in connection with built-up type contact protection. Capacitor and resistor values of networks are entered in a Circuit Note. Polarity is not intended by the double line side of the symbol.

(1) 2-, 3-, or 4-terminal network

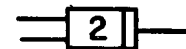

OR



(See preceding note.)

(DISCONTINUED)

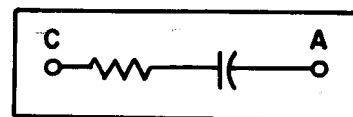

2.54 Open (coaxial and waveguide application) [see paragraph 2.21(c).]



2.55 Oscillator



2.56 Paths (transmission), Conductors, Wiring, etc

Note: A single line represents the entire group of conductors or the transmission path needed to guide the power or the signal. For coaxial and waveguide work, the recognition symbol is used at the beginning and end of each kind of transmission path and at intermediate points as needed for clarity. In waveguide work, mode may be indicated.

(a) Line thickness

Transmission paths (talking and telegraph), bus bar charge and discharge leads

Note: When this line symbol is used for transmission paths on drawings, it is not to be used for the other indicated uses on the same drawing.

Fundamental circuit

Off-normal ground

Off-normal battery

Sequence switch rotary magnetic feed

Division line used between figures

Symbols, signaling, and power control

Note: Symbols drawn in ink may be shown with a thinner line

Circuit connections shown on other drawings, mechanical linkage, shielding, and information continuity

Cross-connection wire

Boundary of mechanical grouping

(b) More-than-one lead representation



(c) Paired twisted wires

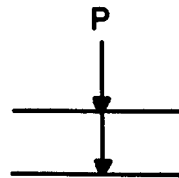

(d) Paired wires with other than frequency of twist obtained when pairing (P) symbol only is specified.

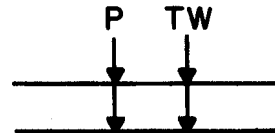

(e) Triple twisted wires

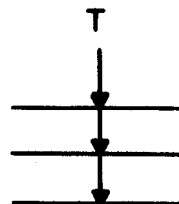

2.56 (Contd)

(f) 4-wire twist

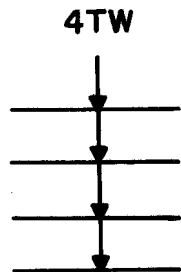

(g) Quad (two pairs twisted)

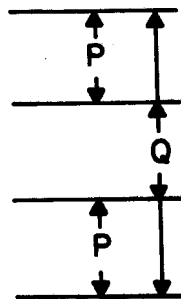

(h) Cross-connection wires

(1) One-conductor cross-connection wire

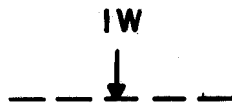

(2) 2-conductor cross-connection wire

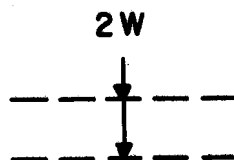

(3) 3-conductor cross-connection wire

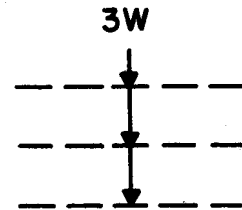

(4) 4-conductor cross-connection wire (spiral)

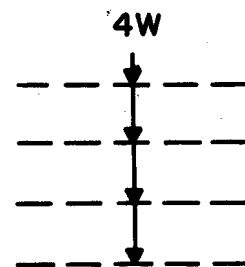

(5) Multiple twin cross-connection wire

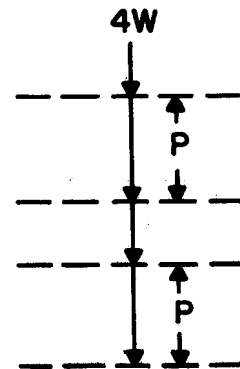

(i) Cable, general, switchboard

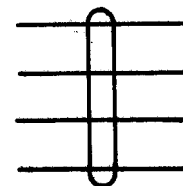

2.56 (Contd)

(j) Cable, coaxial

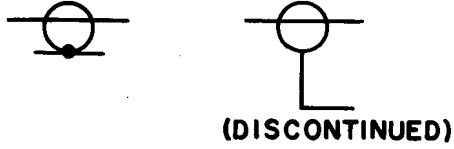

(n) Leads run from terminal to terminal

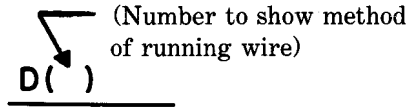

(k) Stripline

(1) Unbalanced



(2) Balanced

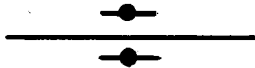

(o) Shielded single wire

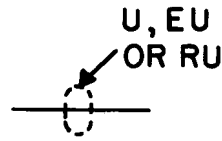

(p) Individually shielded wires with the shields connected together to earth ground or chassis connection

(l) Local cable or loose wiring

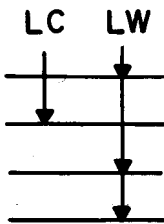

(m) Leads requiring segregation for crosstalk control, etc

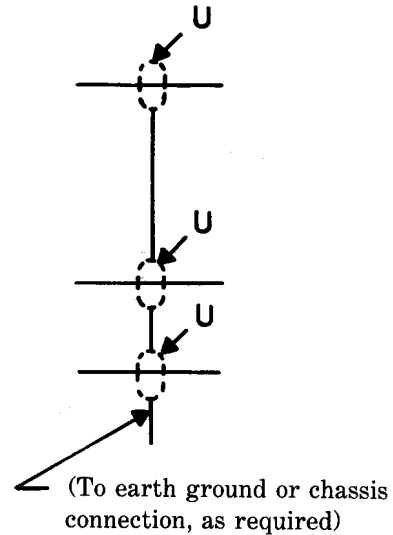

2.56 (Contd)

(q) Wires in same shield

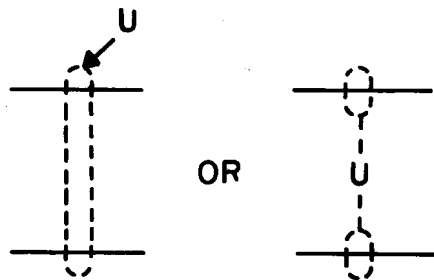

(r) Typical paired and shielded wires

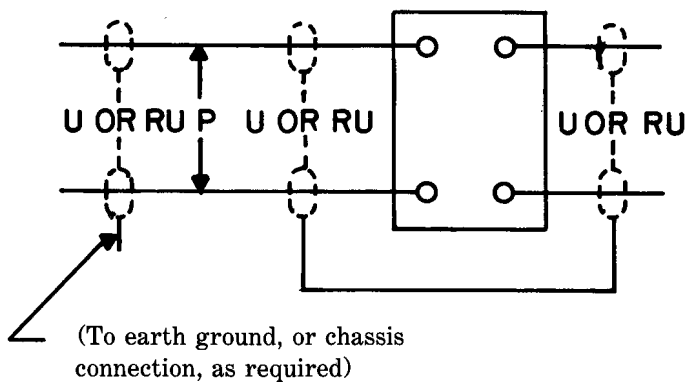

(s) Crossover (no junction)

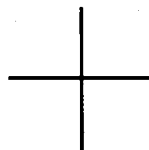

(t) Single junction

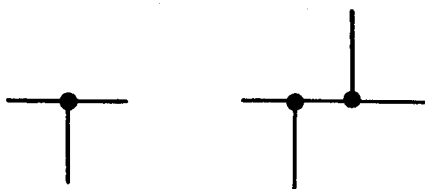

(u) Spliced wires

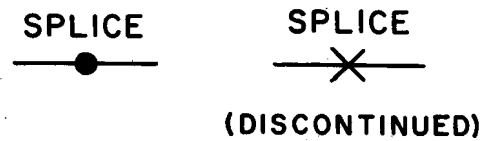

(v) Multiple connection



(w) Optional or alternative paths

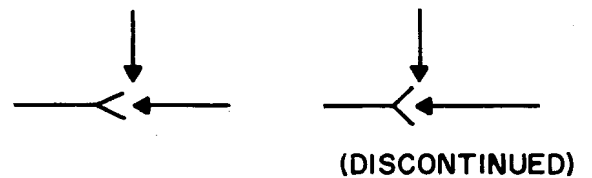

(x) Looping (detached contact application) used to indicate continuous wiring when associated option is not furnished



(y) Waveguide, transmission path (see note under paragraph 2.56)

(1) Circular waveguide



(2) Rectangular waveguide



SECTION 005-108-111

2.56 (Contd)

(3) **Ridged waveguide**

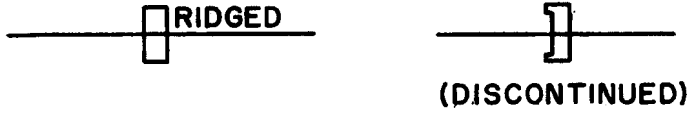

(z) **Intentional isolation of direct-current path (coaxial or waveguide)**



2.57 Permanent Magnet

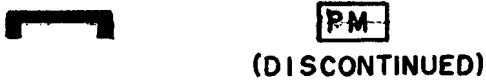

2.58 Plug [see paragraph 2.17(g)]

2.59 Point, Test



Test points such as a jack or terminal shall be designated TP

2.60 Polarity Mark

Note: Dots adjacent to windings indicate instantaneous similar polarity in windings at points where dots are shown.

(a) **Application**

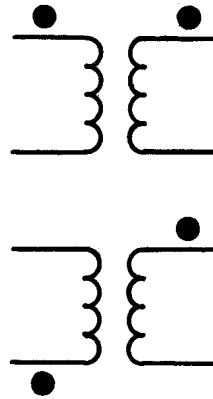

2.61 Post, binding



2.62 Receiver (also see paragraphs 2.33, 2.34, and 2.46)

(a) **General**

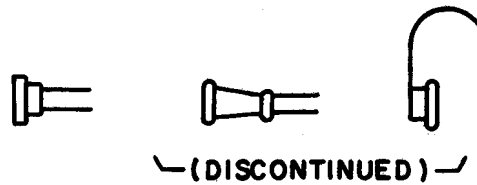

(b) **Double headset receiver**

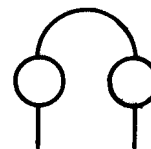

2.62 (Contd)

(c) Single headset receiver

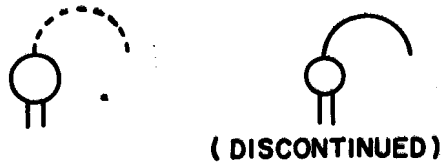

2.63 *Receptacle* [see paragraph 2.17(h)]

2.64 *Rectifier, Metallic* (see paragraph 2.96)

2.65 *Register, Message*



2.66 *Regulator*

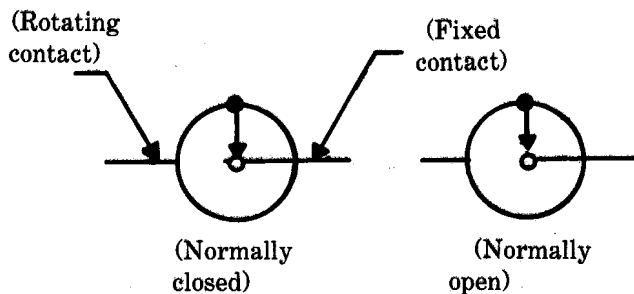

2.67 *Relays* (also see paragraph 2.19)

Note: Show abbreviations as follows for specific operating features, if required. On polarized relays used in telegraph circuits, the designations S and M indicate the "spacing" and "marking" contacts, respectively.

AC — Alternating current

D — Differential

DB — Double-biased — biased in both directions

DP — Dashpot

EP — Electrically polarized

FO — Fast operate

FR — Fast release

MG — Marginal

ML — Magnetic latching

NR — Nonreactance

P — Magnetically polarized using biasing spring or having magnetic bias

SA — Slow acting

SO — Slow operate

SR — Slow release

TS — Two-step

2.67 (Contd)

(a) Single-wound relay with make-contact

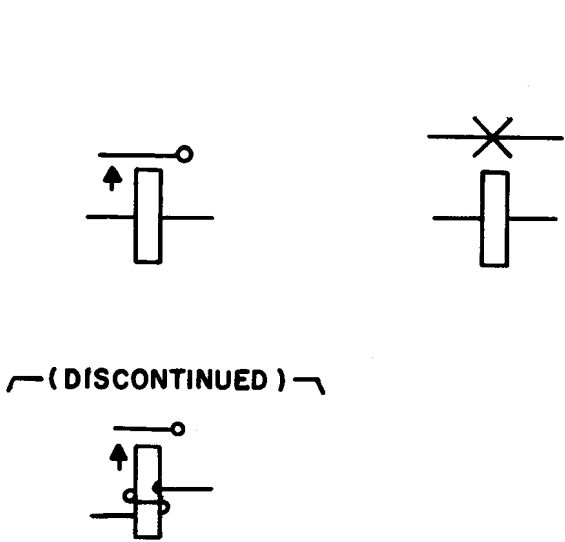

(b) Double-wound relay with break- and make-before-break contacts

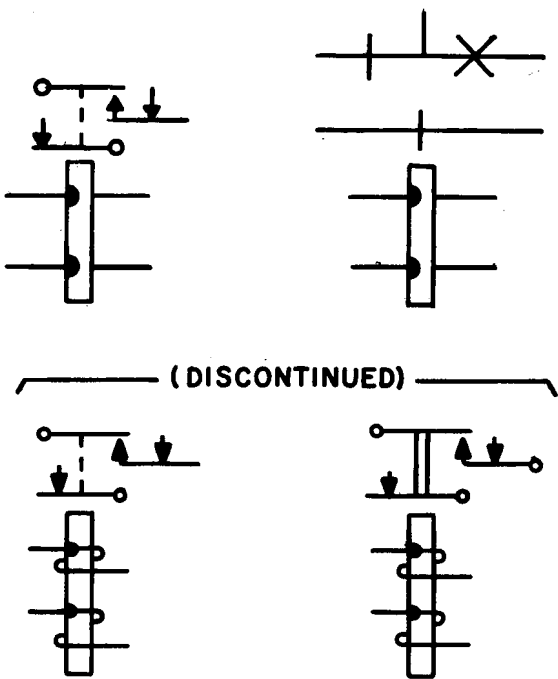

(c) Relay with noninductive winding and transfer contacts

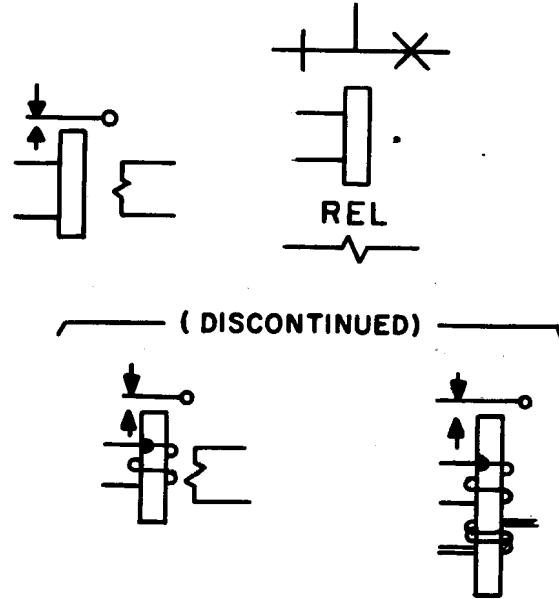

(d) Relay with preliminary make-contact

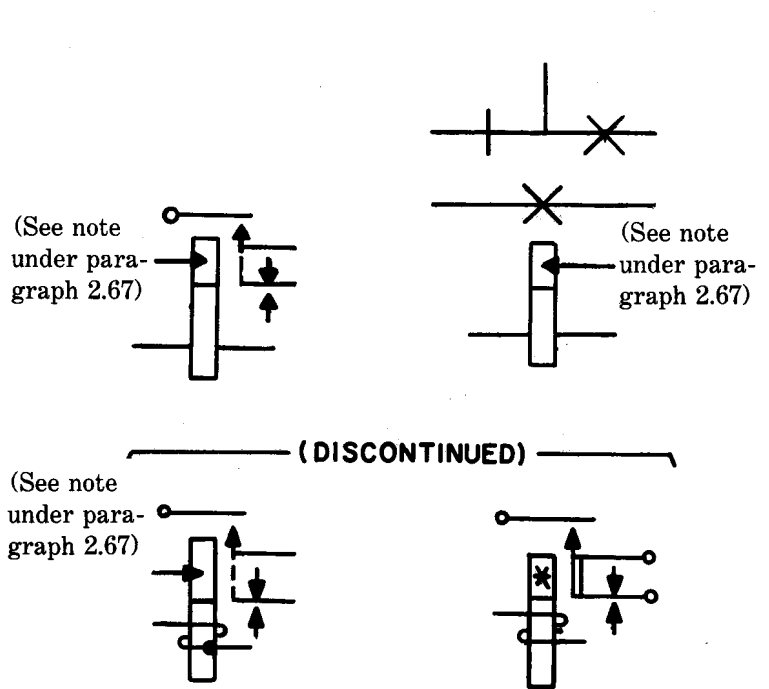

2.67 (Contd)

(e) Relay in normally energized state

Note 1: Terminal numbers are shown for correlation only.

Note 2: When detached contact symbol is used, the words "see note" (sheet Note No.) should be shown adjacent to core symbol. When any of the relay contacts are shown on another sheet of the SD drawing. See note reference should also be shown adjacent to the contacts. The sheet note should read: RELAY NORMALLY ENERGIZED.

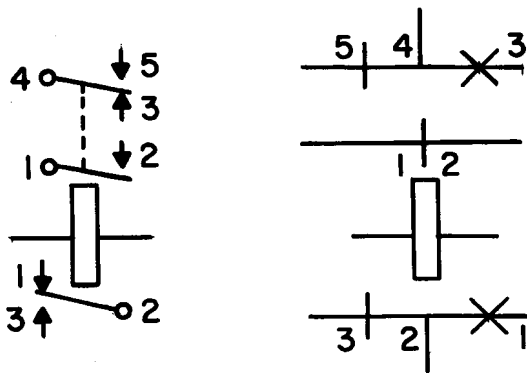

—(DISCONTINUED)—

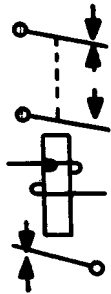

(f) Wire-spring relay

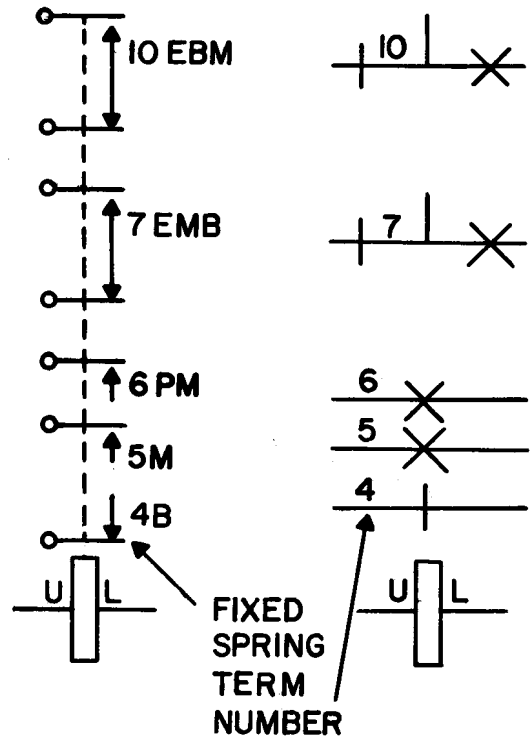

Note: Only the fixed spring terminal number shall be shown for wire spring relays since the make-or-break-contact associated with it is referred to by the same number.

2.67 (Contd)

(g) Multicontact relay (flat-spring type)

(1) Nonsplit multicontact relay

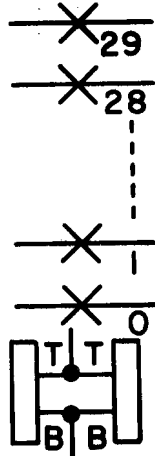
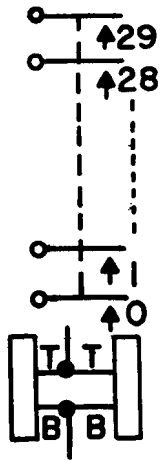

(2) Split multicontact relay (flat-spring type)

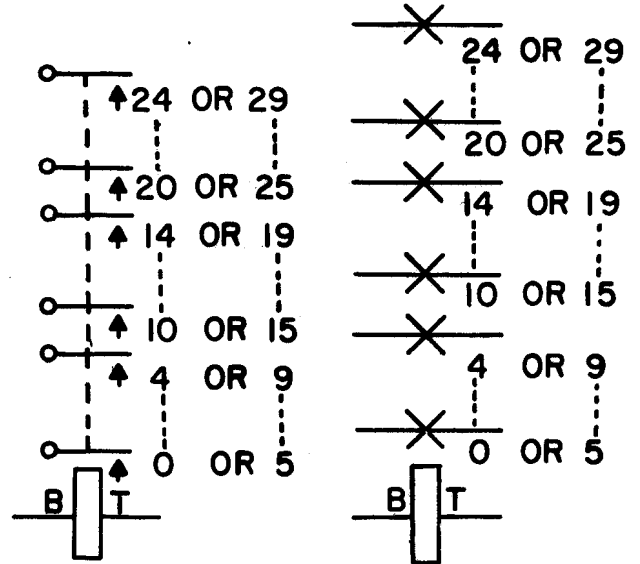

(DISCONTINUED)

(DISCONTINUED)

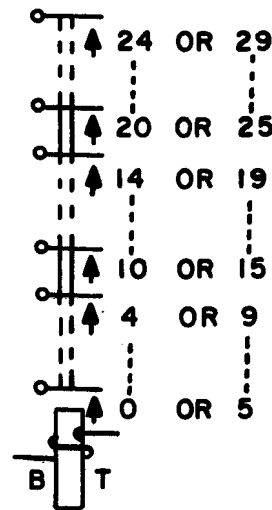
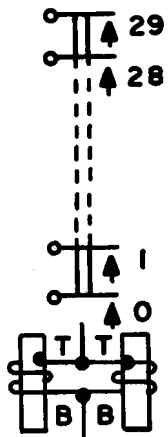

2.67 (Contd)

- (3) Single unit multicontact relay—30 contacts (wire-spring type)

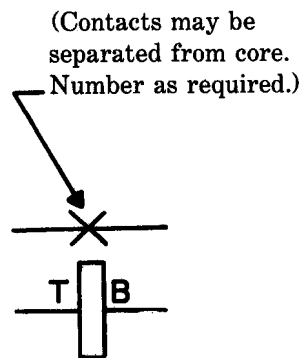
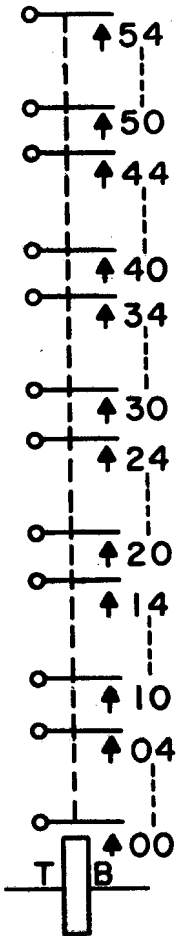

- (4) Nonsplit double unit multicontact relay—60 contacts (wire-spring type)

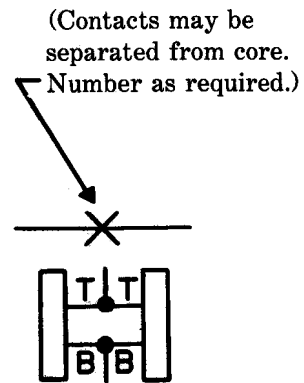
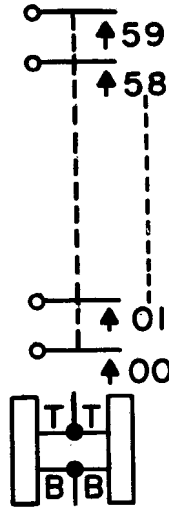

2.67 (Contd)

- (5) Split double unit multicontact relay—30 contacts per unit (wire-spring type)

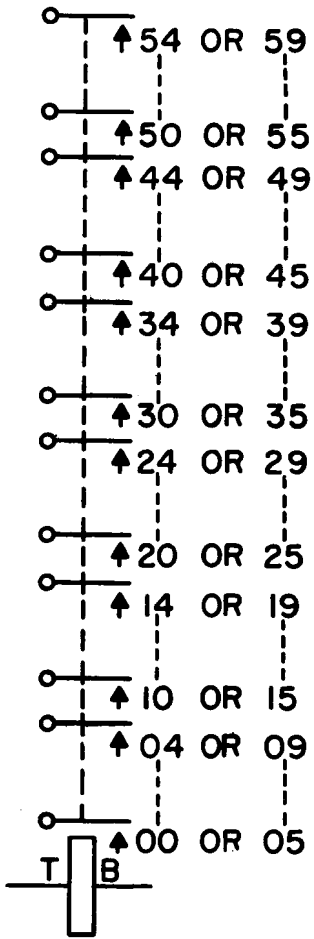

(Contacts of each unit may be separated from core. Number as required.)

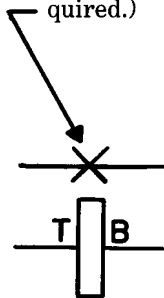

- (h) Mechanically locking and electrically releasing relay

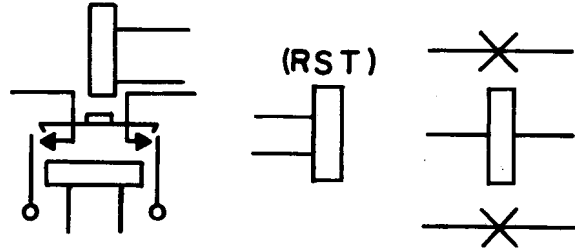

(DISCONTINUED)

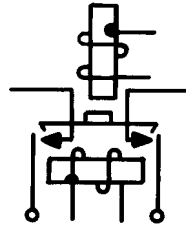

- (i) Solenoid-type relay [see paragraph 2.19(b)]

- (j) Polarized relay (telegraph) (see note under paragraph 2.67)

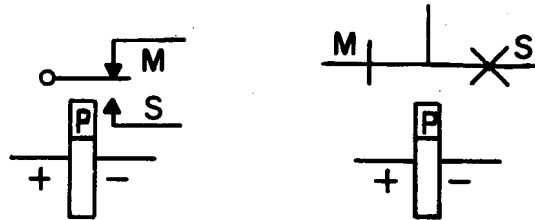

(DISCONTINUED)

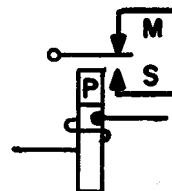

2.67 (Contd)

(k) Double contact-type relay

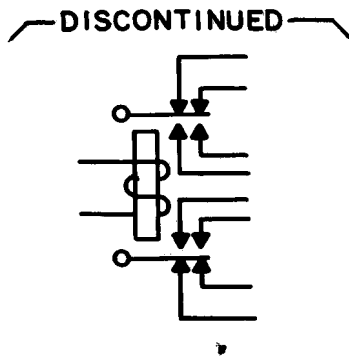
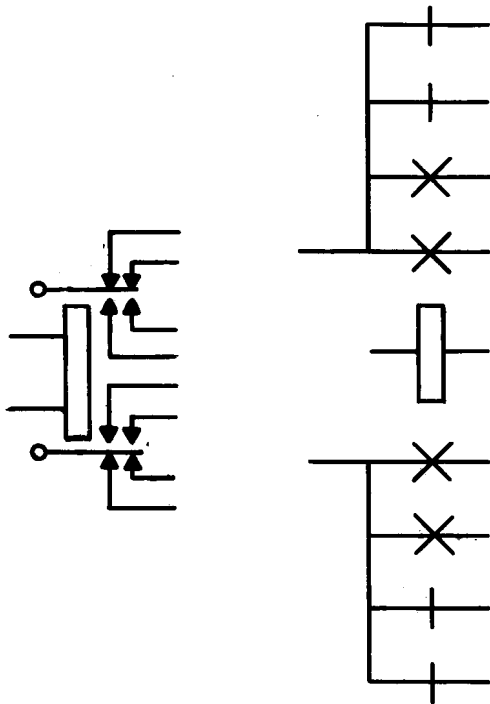

(l) Ammeter-type relay

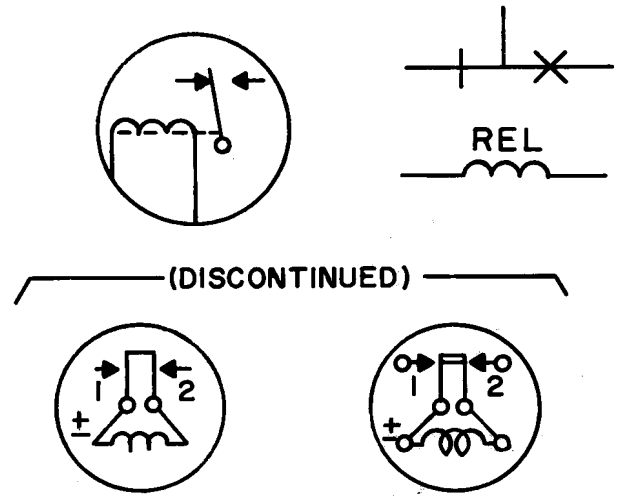

(m) Sensitrol-type relay

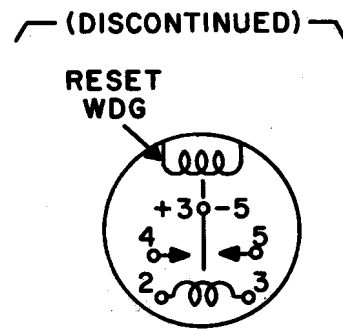
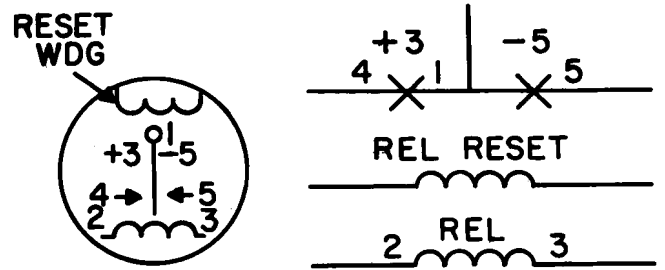

2.67 (Contd)

(n) Mercury contact-type relay

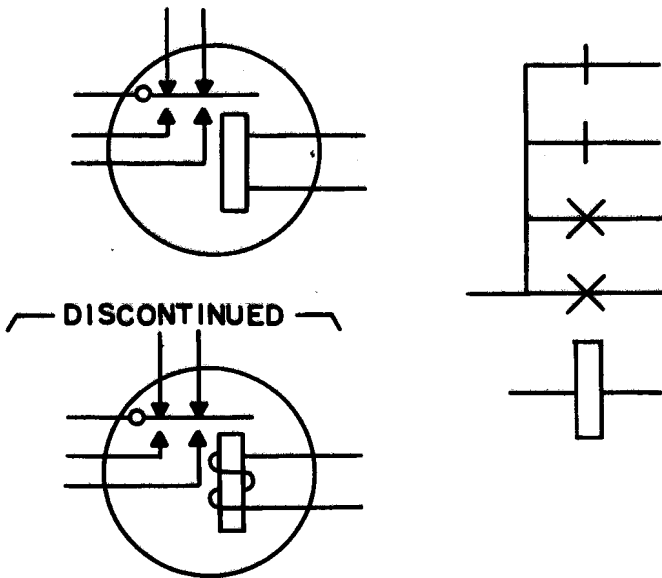

(o) Voltage-type relay

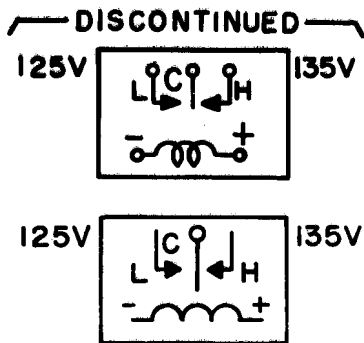
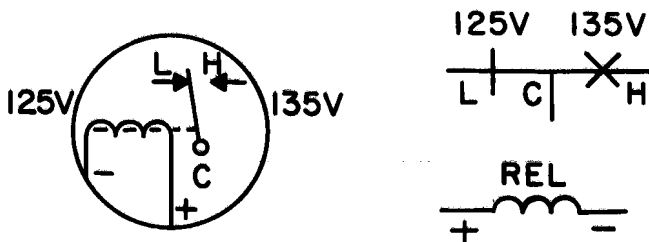

2.68 Resistor

(a) Resistor (carbon or wire)



(b) Resistor with two windings, having one terminal common to both windings



(c) Relay spool-type resistor

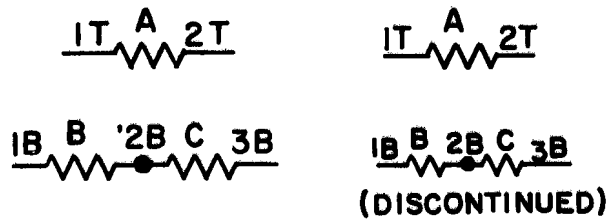

(d) Tapped windings

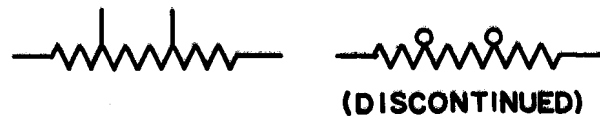

(e) Adjustable (rheostat and potentiometer)

Note: CW indicates position of adjustable contact at the limit of clockwise travel viewed from knob or actuator end, unless otherwise indicated.

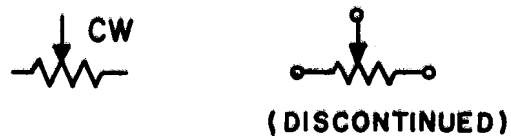

(See preceding note.)

2.68 (Contd)

(f) Heating resistor



2.69 Resonator [excluding piezoelectric and magnetostriction devices (microwave circuitry)]

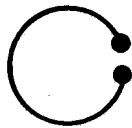

(a) Application

(1) Resonator coupled by an aperture to rectangular waveguide and by a loop to a coaxial (with mode suppression)

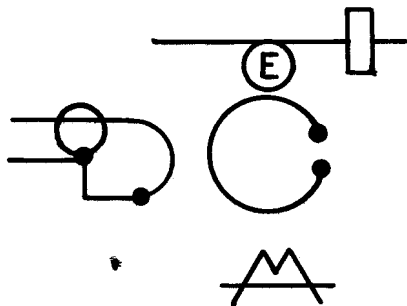

(2) Resonator coupled by a probe to a coaxial (with tuning, variable Q)

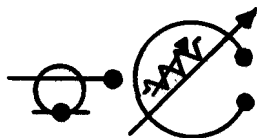

2.70 Telephone Ringer (also see paragraph 2.08)

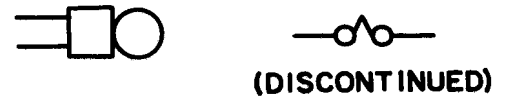

2.71 Rotary joint (waveguide circuitry)

(a) General (with rectangular waveguide system)



(b) Coaxial type in rectangular waveguide system



(c) Circular waveguide type in rectangular waveguide system



2.72 Selector

Note: Terminal and position identifications are for illustration only.

(a) 10-terminal rotary-type selector

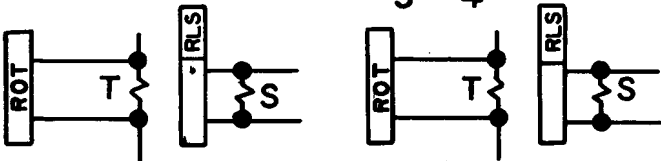
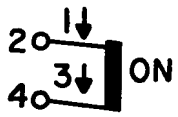
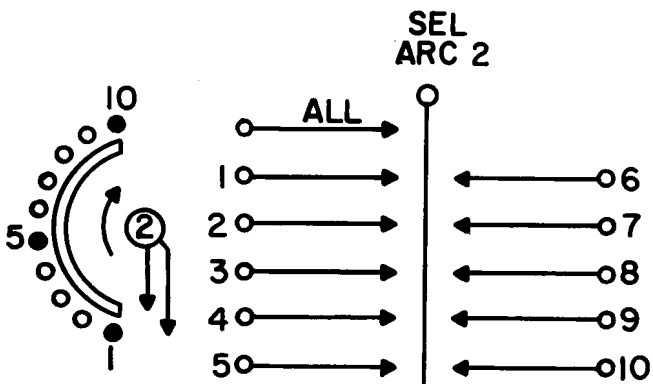
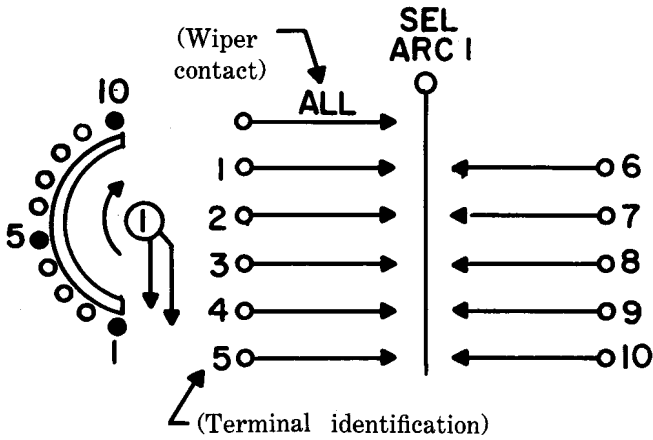

DISCONTINUED

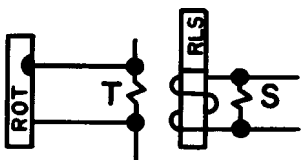

(b) 22-terminal rotary-type selector

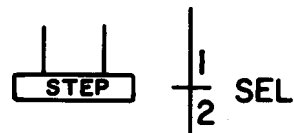
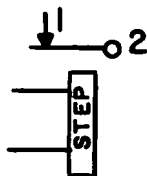
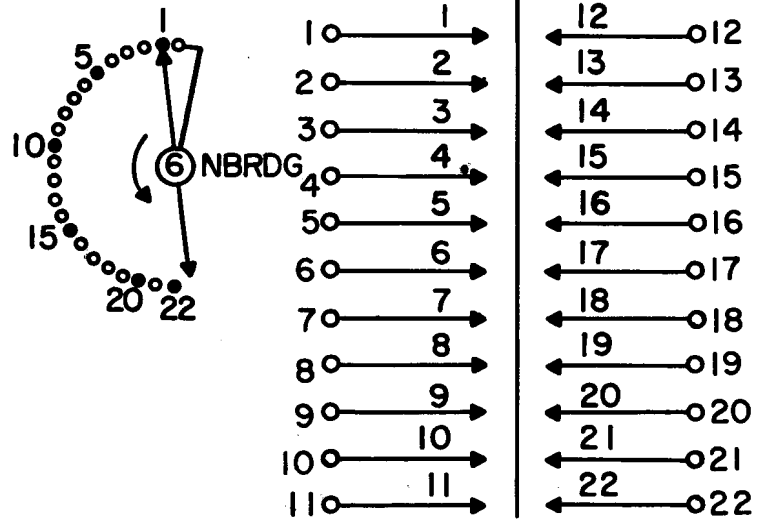
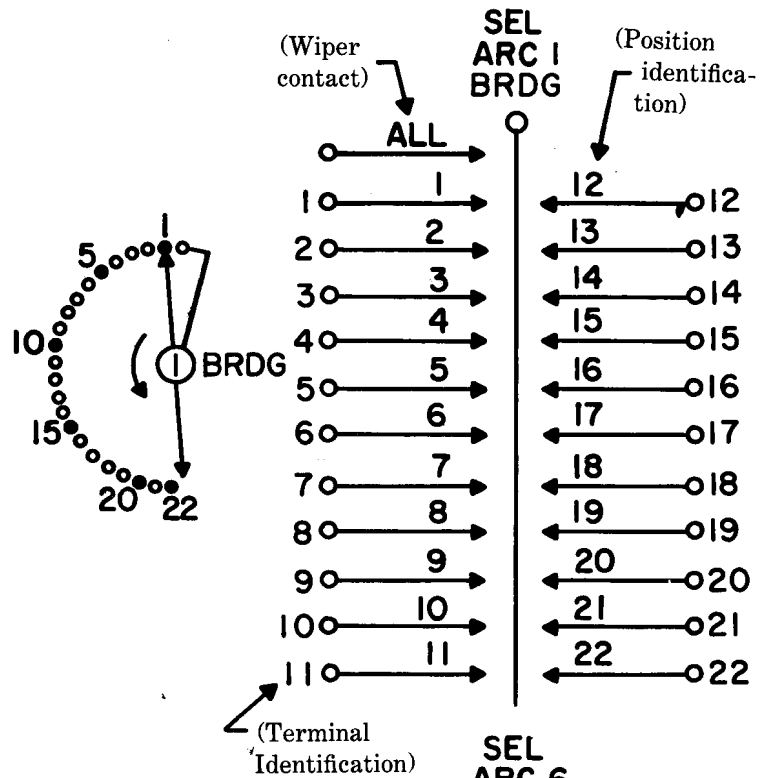

2.73 (Contd)

(f) P emitter on N region



(g) N emitter on P region



(h) Collector on semiconductor region



(i) Transition between regions of dissimilar conductivity types either P to N or N to P. (The short slant line indicates point of change along the horizontal line from P to N or N to P. No connection shall be made to the short line.



(j) Insulated gate

Note: The L-shaped insulated gate element shall be drawn with one side spaced from, and parallel to, the channel between ohmic contacts. The corner of the gate element shall be drawn opposite the preferred source ohmic contact.

(1) Single



(2) Multiple

Note: The insulated gate drawn opposite the preferred source is designated as the primary gate. Additional gates are secondary gates.



(k) Gate control electrode

(1) General



(2) Turnoff feature



(l) **Special Properties**

Note: If necessary, a special function or property essential for circuit operation may be indicated by a supplementary symbol placed adjacent to the symbol.

(1) Nonionizing electromagnetic radiation (such as radio waves, infrared, visible or ultraviolet light)

(a) Sensitivity indicator

Note: Arrows point toward associated symbol.



(DISCONTINUED)

λ

2.73 (Contd)

(b) Emissivity indicator

Note: Arrows point away from associated symbol.



(2) Temperature dependence



(DISCONTINUED)



(3) Capacitive property

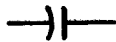

(DISCONTINUED)



(4) Tunneling property



(5) Breakdown property



(DISCONTINUED)



(6) Saturable (general) property



(7) Storage property



(8) Surge protector property indicator



2.73 (Contd)

(m) Applications; two terminal devices

- (1) Semiconductor diode (PN diode) Semiconductor rectifier diode

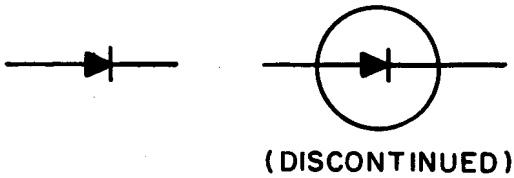

- (2) Capacitive diode (varactor)



- (3) Voltage regulator diode, unidirectional

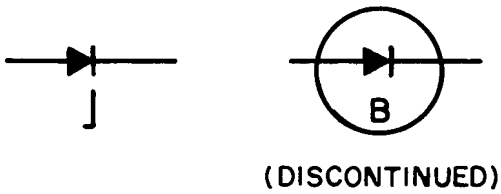

- (4) Voltage regulator diode, bidirectional

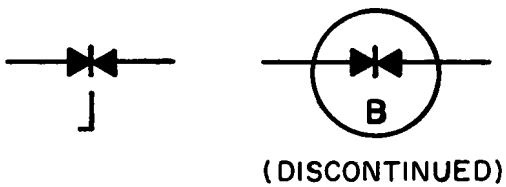

- (5) Tunnel diode

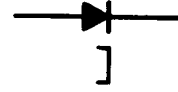

- (6) Temperature dependent diode



- (7) Avalanche breakdown diode, unidirectional

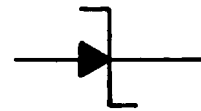

- (8) Avalanche breakdown diode, bidirectional

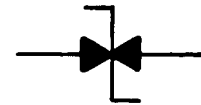

- (9) Photoemissive-type diode also LED (light emitting diode)

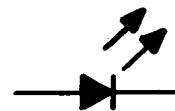

2.73 (Contd)

(10) Junction laser

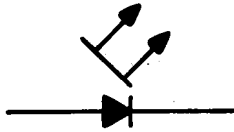

(11) Photosensitive-type diode also PIN (positive-intrinsic-negative) diode

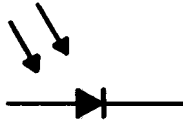

(12) Avalanche Photodiode—APD

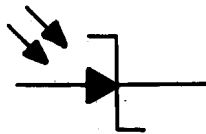

(13) Schottky barrier diode

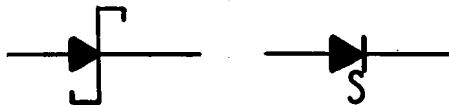

(DISCONTINUED)

(14) Storage diode



(15) Surge protector diode



(16) Current regulator

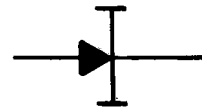

(n) Applications; three or more terminal devices

Note 1: Letters in parentheses, for example: (B) bulk (substrate), (D) drain, (G) gate, (S) source, are for explanation and are not part of the symbol.

Note 2: The envelope symbol may be omitted if no confusion results or if no elements are connected to the envelope.

2.73 (Contd)

- (1) PNP transistor (also PNIP transistor, if omitting the intrinsic region will not result in ambiguity)

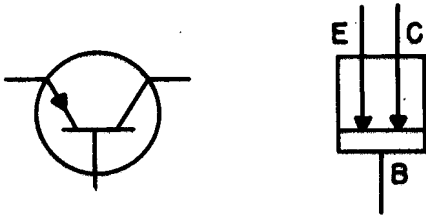

(DISCONTINUED)

- (2) PNP transistor with one electrode connected to envelope (in this case the collector electrode)

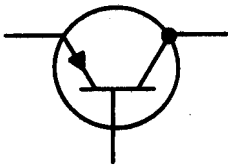

- (3) NPN transistor (also NPIN transistor, if omitting the intrinsic region will not result in ambiguity)

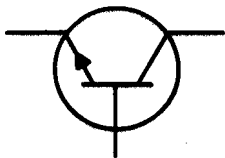

- (4) Double NPN transistor

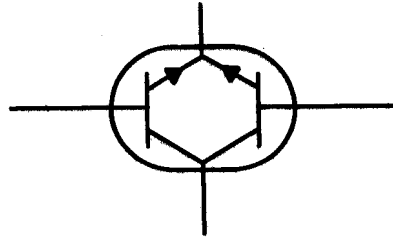

- (5) Unijunction transistor with N-type base

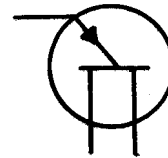

- (6) Unijunction transistor with P-type base

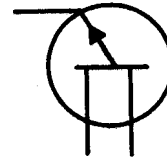

- (7) NPN transistor with transverse-biased base

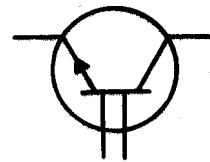

2.73 (Contd)

(8) Schottky-clamped transistor

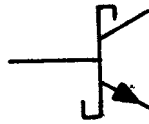

(9) Junction field effect transistors, JFETs

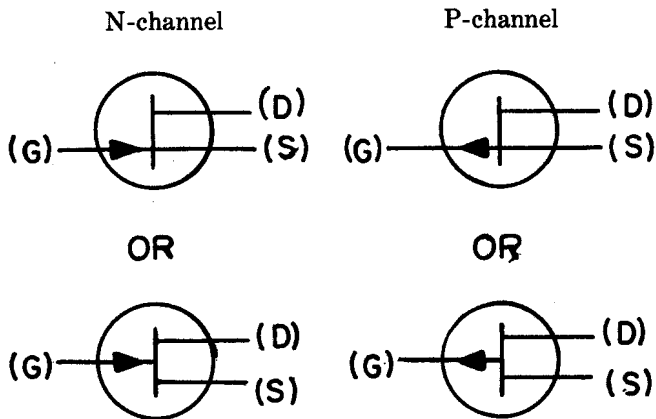

(10) Insulated gate field effect transistors, IGFETs

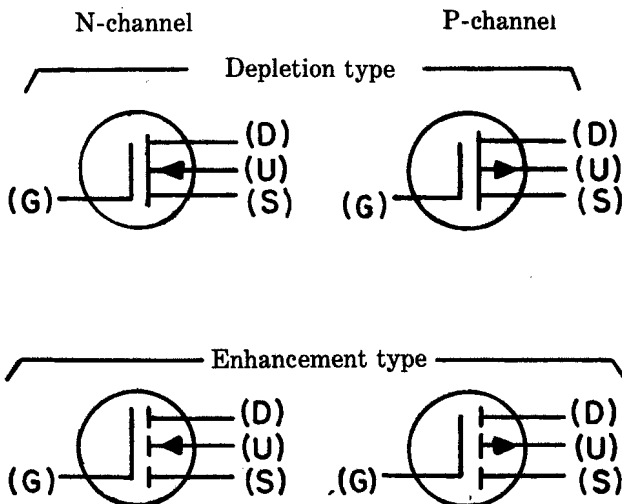

(11) Opto-isolator (Photon-coupled isolator)

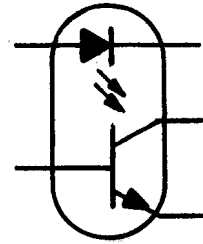

(12) Thyristor—NPNP or PNPN transistor



(13) Thyristor—Silicon controlled rectifier (SCR)

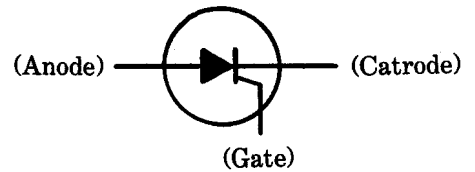

(14) Triac (bidirectional Triode thyristor)

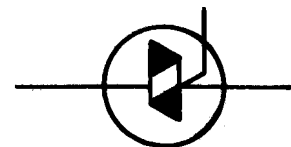

2.73 (Contd)

(15) Photo-darlington-detector

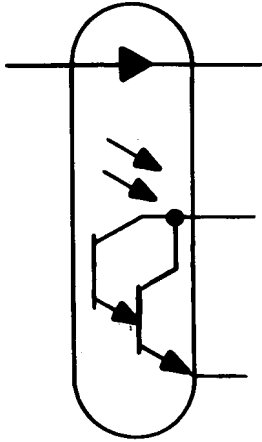

2.74 Sensor, Ferrod

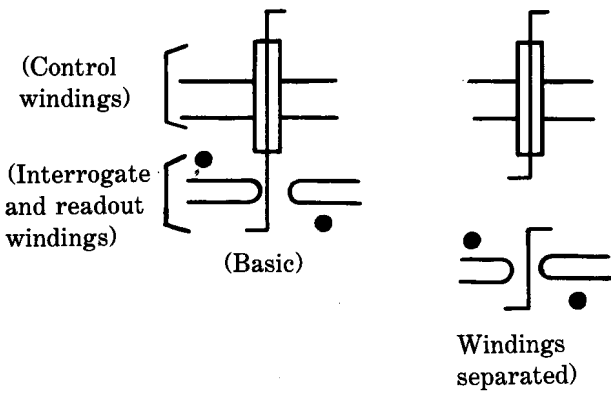

2.75 Set, Engine-Generator

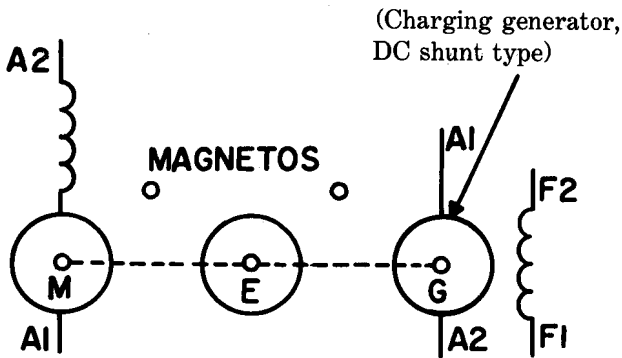

(With starting motor and magnetos)

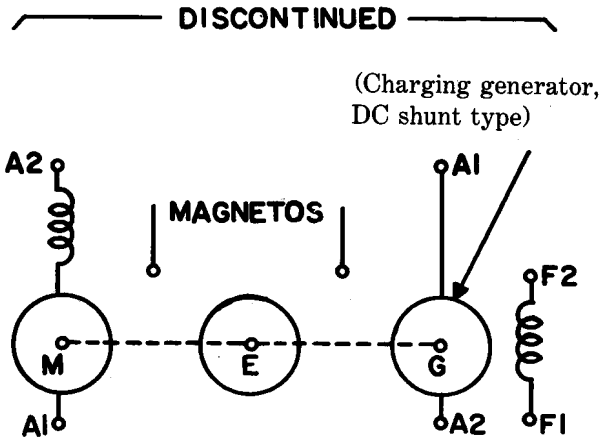

2.76 Shifter, Phase (microwave circuitry)

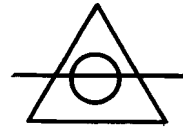

2.77 Short (microwave circuitry)

(a) Transmission path terminated in a short

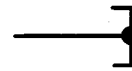

(b) Movable short

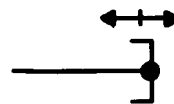

2.78 *Signal*

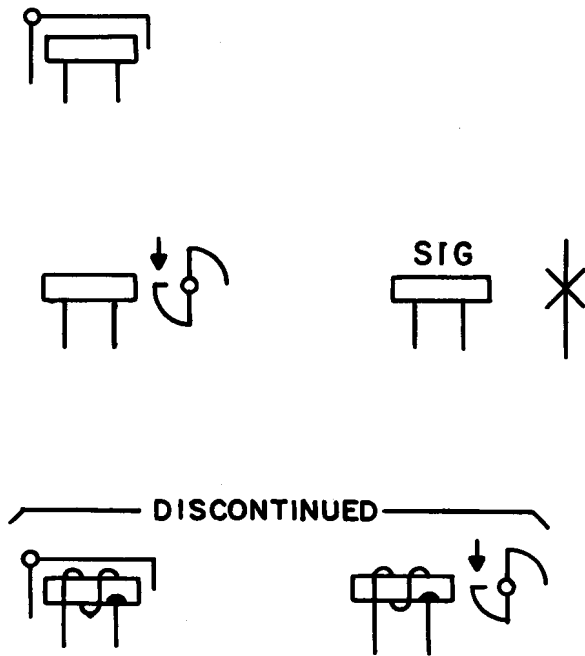

(b) Telegraph-type sounder

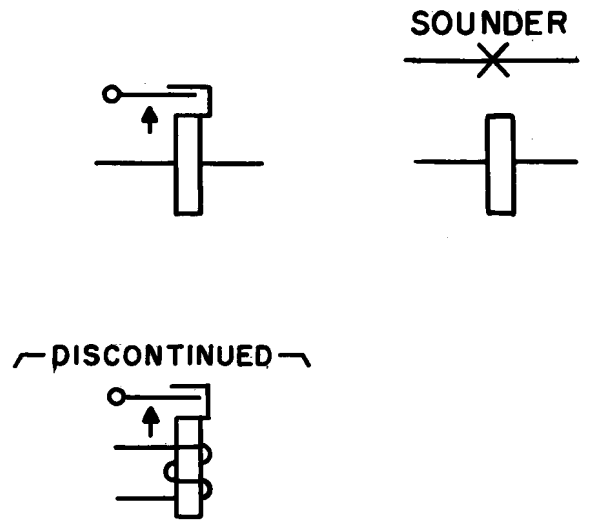

2.79 *Sounder*

(a) Chime, tone bar, etc, type sounder

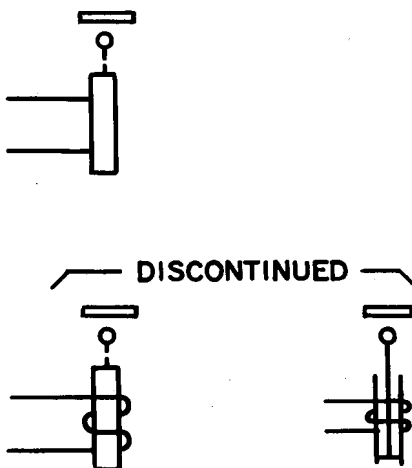

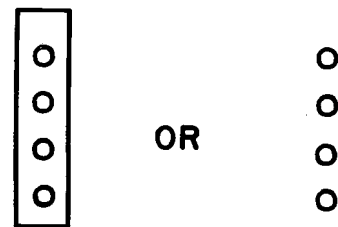

2.80 *Strip, Terminal*



2.81 *Suppression, Mode* (microwave circuitry)



2.82 Switch

Note: The following symbols show the standard method of illustrating switches in a position with no operating force applied. The  and  alternative symbol representations are to be used only when switch contacts or activating devices are shown at different locations on the drawing.

- (a) Coaxial or waveguide (any number of transmission paths may be used)

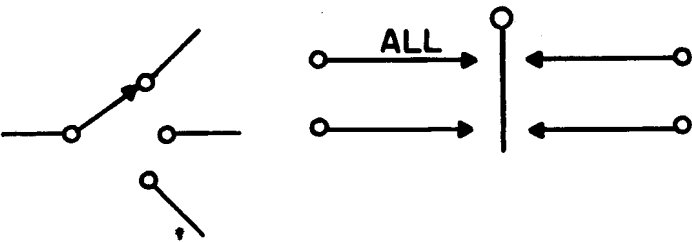

- (b) Step-by-step system selector-type switch

- (1) Wipers and banks

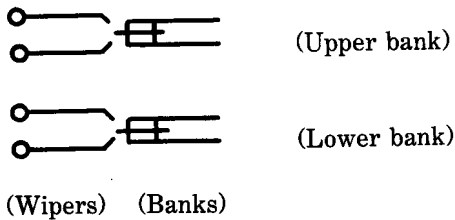

- (2) Vertical commutator and wiper

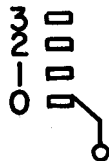

- (3) Normal post springs

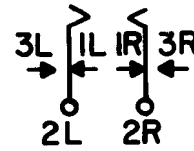

- (4) Magnets

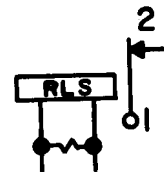
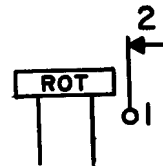
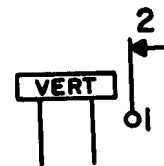

- (5) Vertical off-normal springs

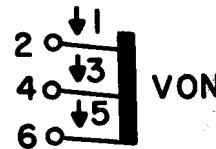

2.82 (Contd)

(6) Rotary off-normal springs



(7) 11th rotary step springs

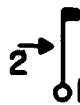

(c) Sequence-type switch

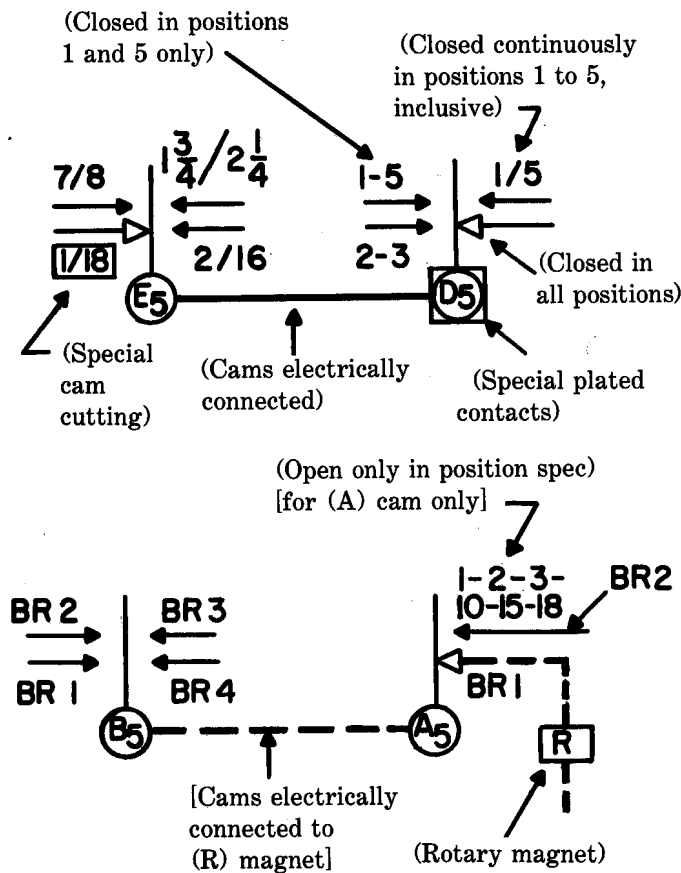

(d) Knife (see note under paragraph 2.82)

(1) Single pole, single-throw



(2) Single pole, double-throw

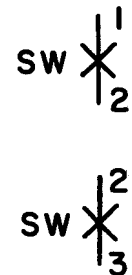
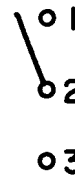

(3) 2-pole, single-throw

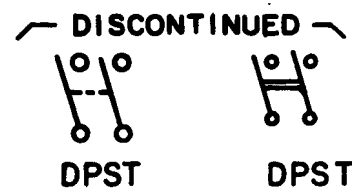
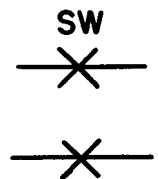

2.82 (Contd)

(4) 2-pole, double-throw

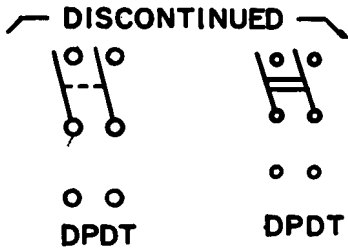
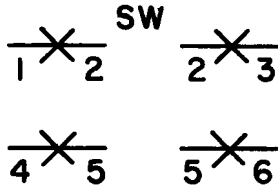
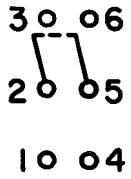

(e) Pushbutton, momentary (see note under paragraph 2.82)

(1) Circuit opening (break)



(2) Circuit closing (make)



(3) 2-circuit

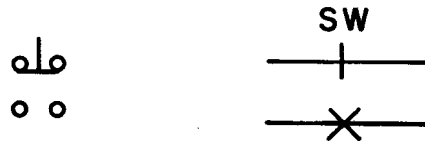

(DISCONTINUED)

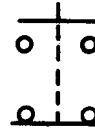

(f) Toggle, momentary (see note under paragraph 2.82)

(1) Circuit closing (make)



(2) Circuit opening (break)



(3) 2-circuit

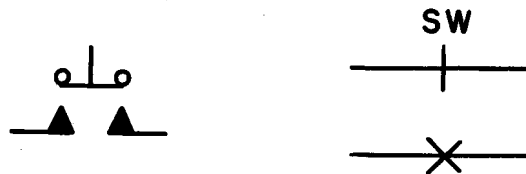

2.82 (Contd)

(4) Multicircuit

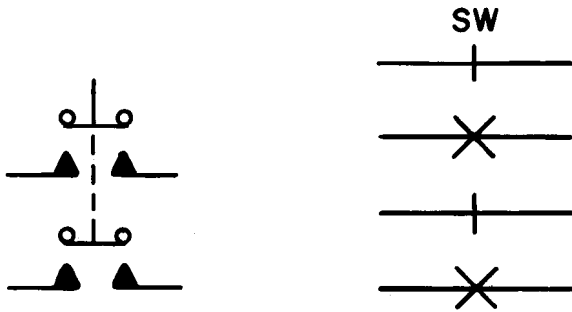

(4) 3-position



(h) Toggle, combination locking and momentary (see note under paragraph 2.82)

(1) 3-position, one-pole: circuit closing, off, momentary circuit closing



(5) Transfer

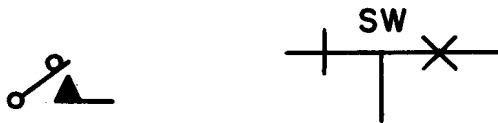

(2) 3-position, 2-pole: circuit closing, off, momentary circuit closing

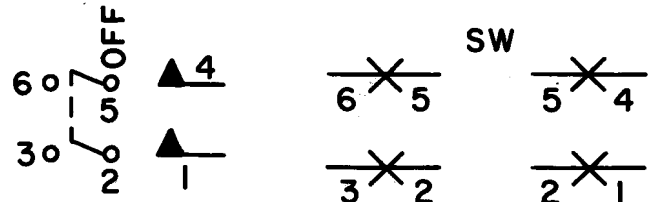

(g) Toggle, locking (see note under 2.82)

(1) Circuit closing (make)



(2) Circuit opening (break)



(3) Transfer



(i) Cover- or door-type switch

(1) Cover or door closed, switch opens when cover or door opens



2.82 (Contd)

(2). Cover or door closed, switch closes when cover or door opens



(j) Screw switch

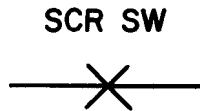
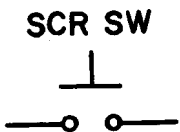

(k) Crossbar selector-type switch

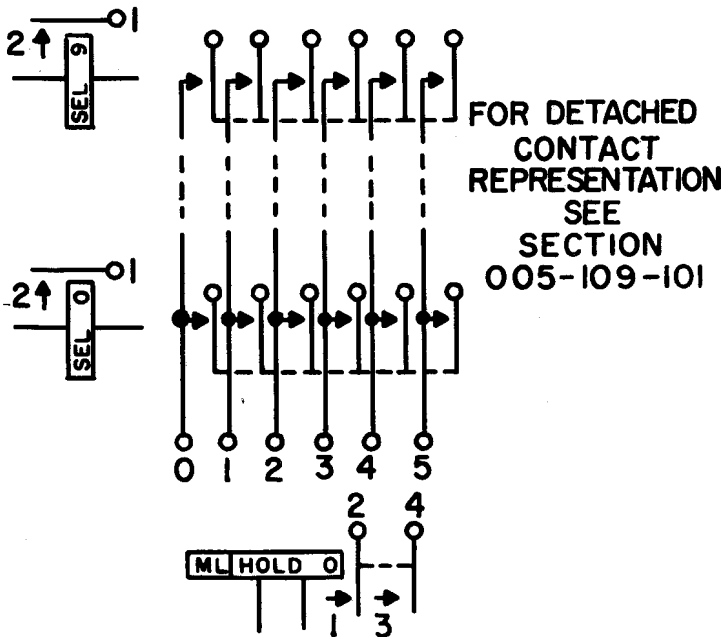

Note 1: SEL magnets may be placed on right or left of contacts as best suits wiring condition.

Note 2: Contacts on SEL or HOLD magnets may be shown at either end of magnet core to suit schematic conditions.

Note 3: HOLD magnets may be shown under SEL magnets where wiring from contact terminals is run vertically.

DISCONTINUED

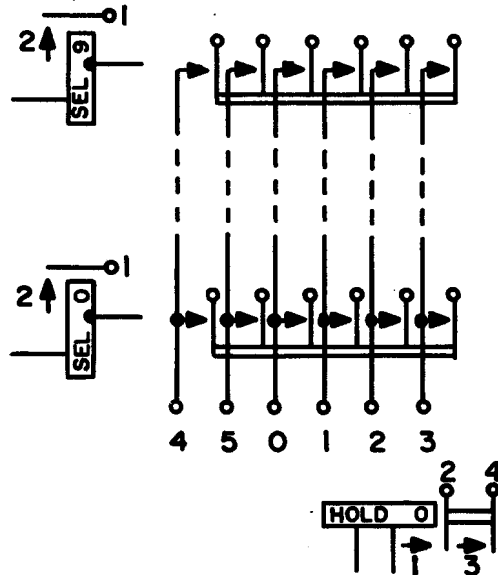

(l) Rotary-type (high voltage)

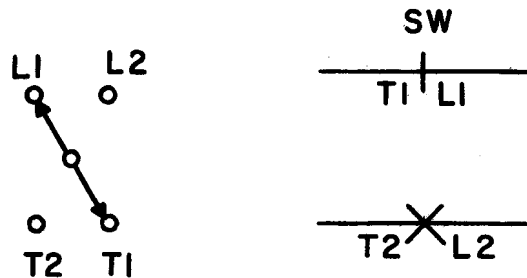

2.82 (Contd)

(1) Application

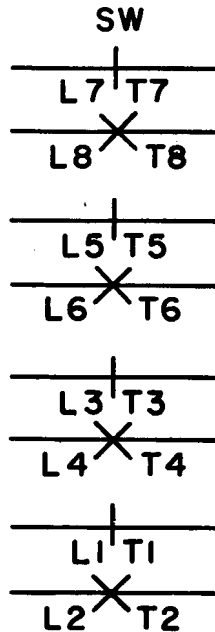
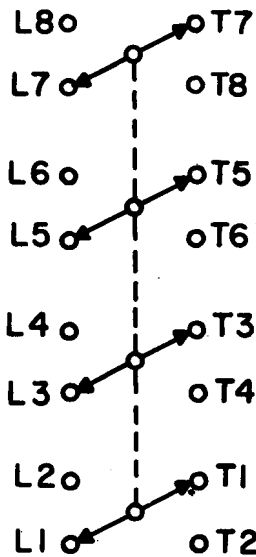

(2) For application in FSs or APP Fig. when required

Note: Symbol shown in extreme counterclockwise position.

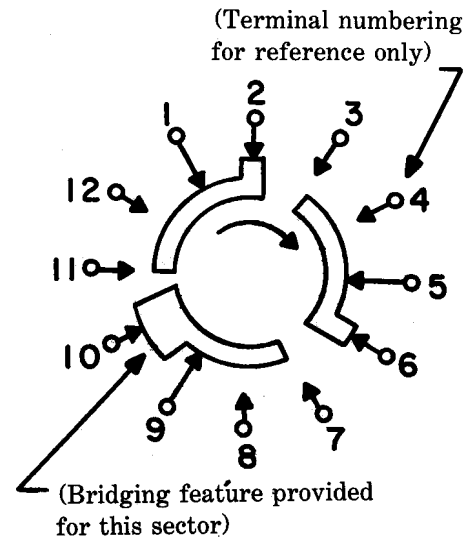

(m) Rotary-type (selector) switch (viewed from knob side, unless otherwise indicated)

(1) For application in FSs

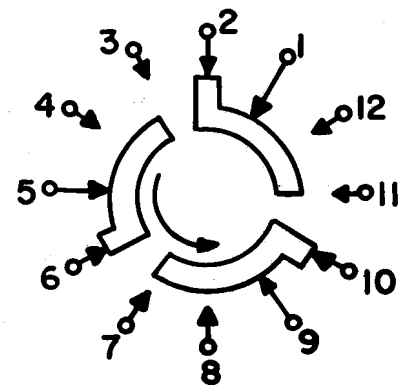
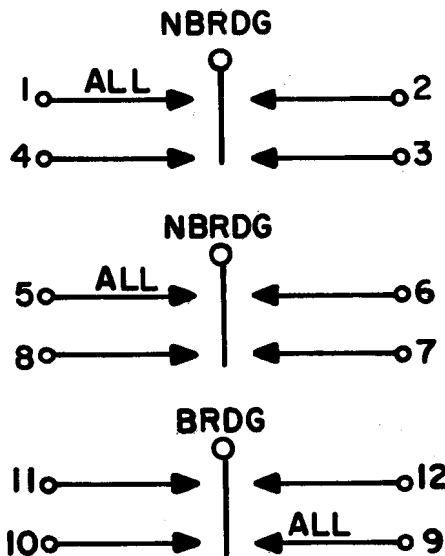

2.82 (Contd)

(n) TOUCH-TONE® pushbutton dial

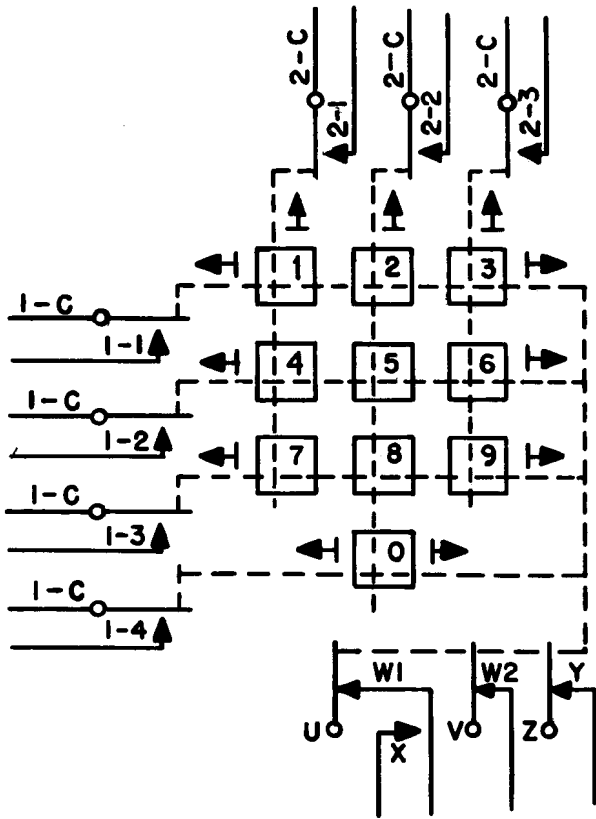

(o) Slide switches

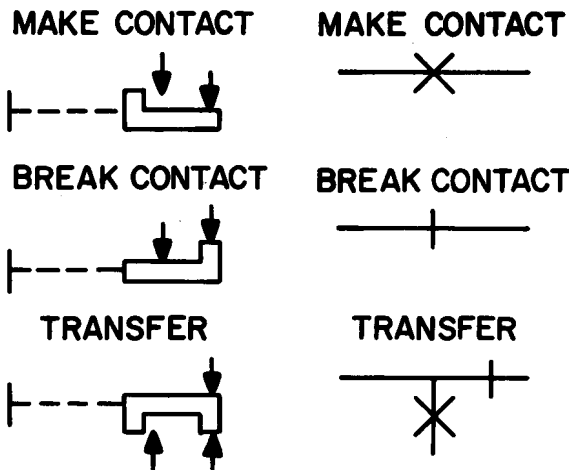

(p) Switch top diagram

(1) Rotary



(2) Toggle



(3) Rocker



2.83 Switchhook

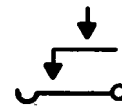

2.84 Terminal

(a) Component terminal



(b) Terminal strip, terminal punching or screw terminal



2.84 (Contd)

(c) Spade tip



(d) Cross-connecting terminal



(e) Coaxial terminal



2.85 Thermal Element

(a) Actuating device



(b) Thermal cutout; flasher



(c) Thermostat (rising temperature)

(1) With make-contact

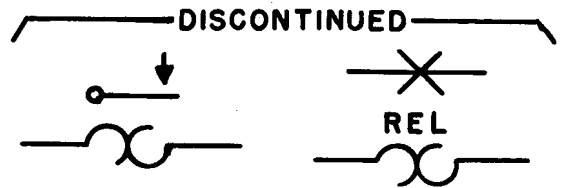
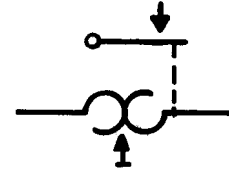

(2) With break-contact

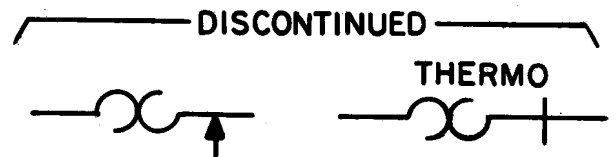
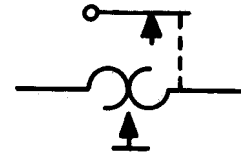

(d) Thermostat (lowering temperature)

(1) With make-contact

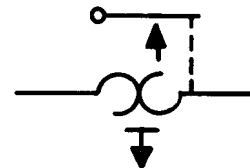

2.85 (Contd)

(2) With break-contact

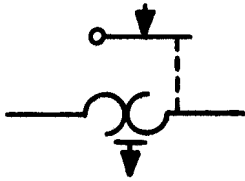

(e) Thermostat with heater unit

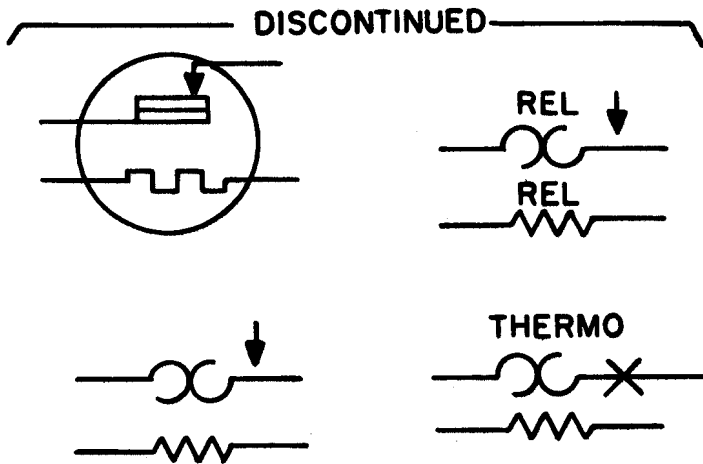
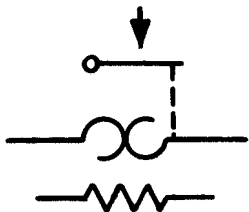

(f) Thermal relay

THRM REL

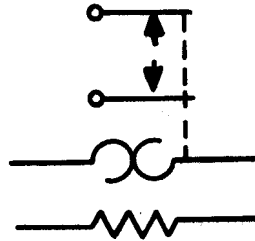

THRM REL

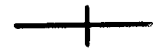

THRM REL



THRM REL

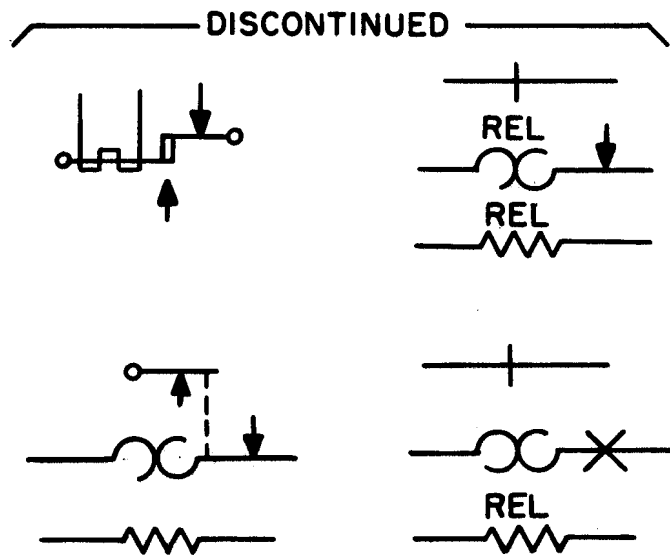

2.86 Thermistor

(a) Directly heated thermistor

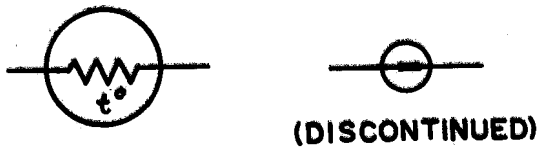

(b) Indirectly heated thermistor

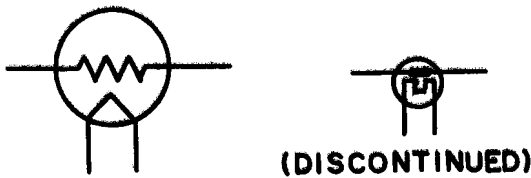

(b) Indirectly heated thermocouple

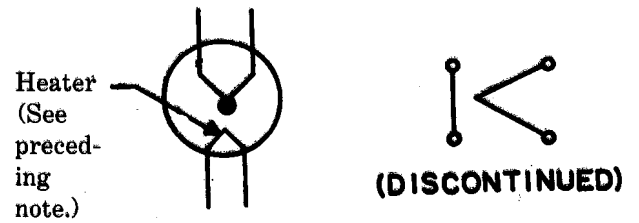

2.88 Thyatron (solid state)



OR

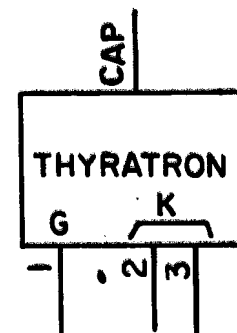

2.87 Thermocouple

Note: Explanatory words and arrows are not a part of the symbols shown.

(a) Directly heated thermocouple

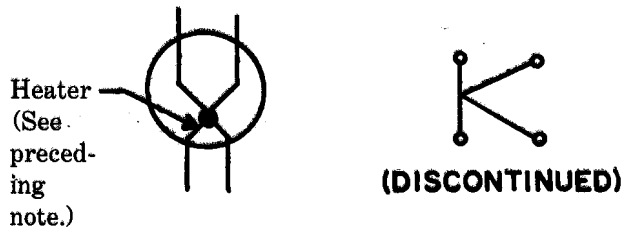

2.89 *Timer*

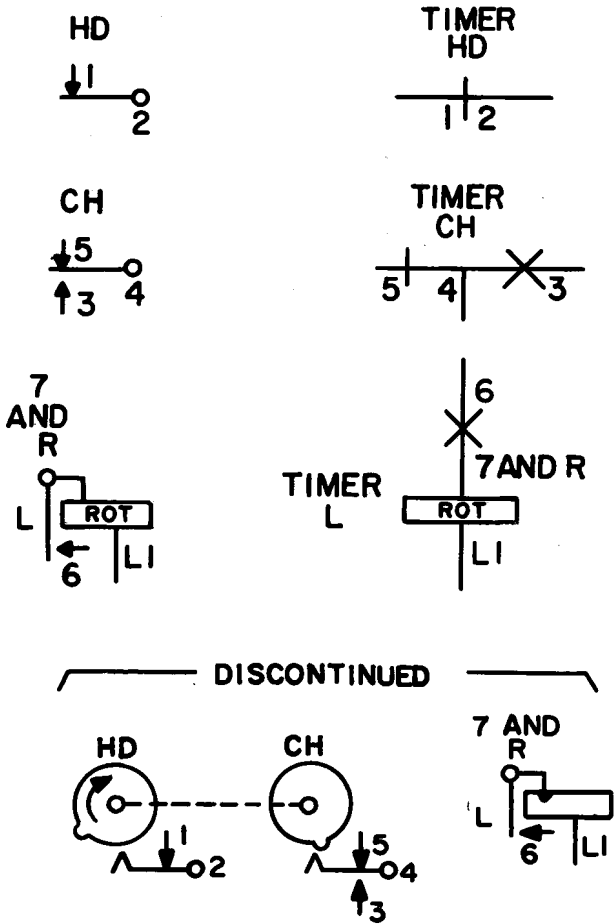

2.90 *Transducer, Mode* (microwave circuitry)



(a) Applications

- (1) Transducer from rectangular to circular waveguide



- (2) Transducer from rectangular waveguide to coaxial with mode suppression

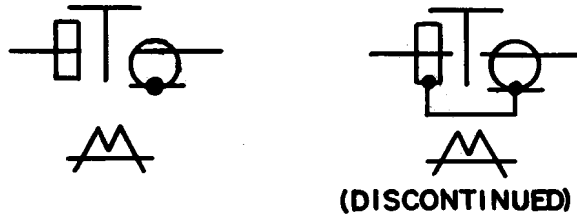

2.91 *Transformation for Tapers and Step Transformers Without Mode Change* (microwave circuitry)

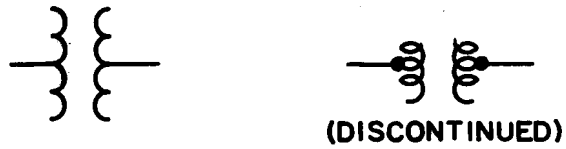

- (a) Application: Transformer with mode suppression

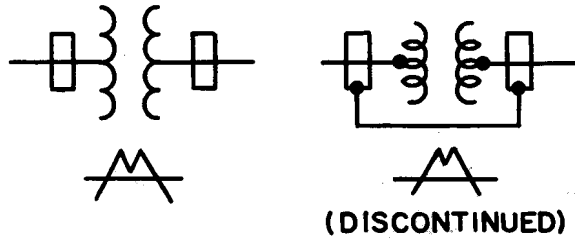

2.92 *Transformer* (Induction coil, repeating coil)

- (a) General

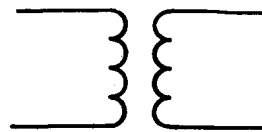

2.92 (Contd)

(b) With magnetic core

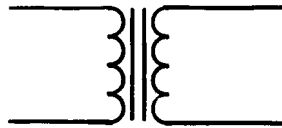

(c) With magnetic core and shield

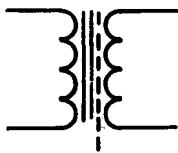

OR

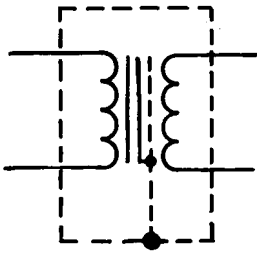

(Shield connected internally to core and case)

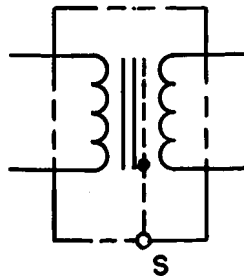

(DISCONTINUED)

(d) With adjustable inductance winding

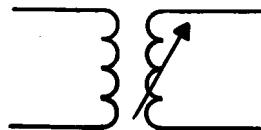

(e) With separately adjustable inductance in each winding

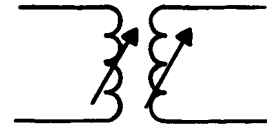

(f) Adjustable mutual inductor, constant-current transformer

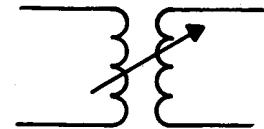

(g) With taps

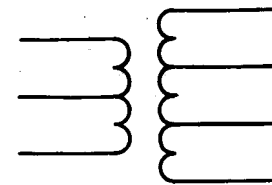

(h) Load-ratio control transformer with taps

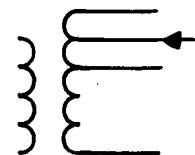

2.92 (Contd)

(i) Multiple winding

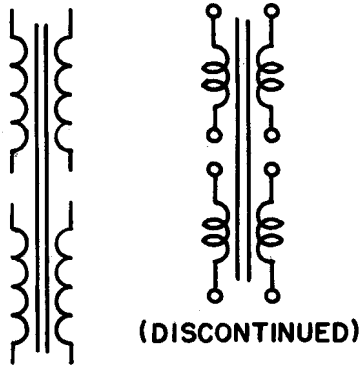

(l) Load-ratio control autotransformer

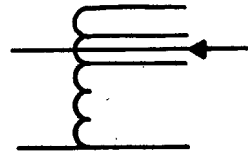

(m) Adjustable tap-type autotransformer

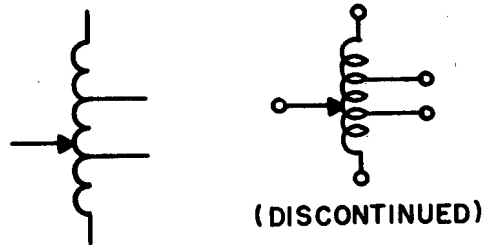

(j) Hybrid type

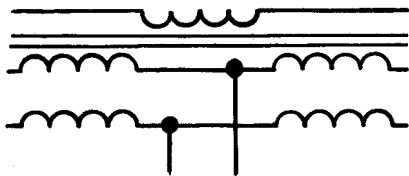

(n) Current

(k) Autotransformer

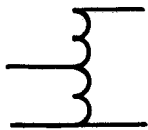

2.93 Transmitter

(l) Adjustable

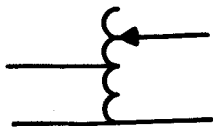

(DISCONTINUED)



2.94 Tube, Electron

(a) Collecting electrode

- (1) Anode or plate (including collecting electrode and fluorescent target)



- (2) Target or X-ray anode (drawn at a 45-degree angle)



(b) Collecting and emitting electrode

- (1) Dynode



(c) Alternately collecting and emitting

- (1) Composite anode-photocathode



- (2) Composite anode-cold cathode



- (3) Composite anode — ionically heated cathode with provision for supplementary heating



(d) Controlling electrode

- (1) Grid (including beam-confining or beam-forming electrodes)



- (2) Deflecting electrodes (used in pairs):
reflecting or repelling electrode (used in velocity-modulated tube)



- (3) Ignitor (in pool tubes) (should extend into pool) or Starter (in gas tubes)



- (4) Excitor (contactor type)



(e) Coupling (see paragraph 2.21)

- (1) Coupling by loop (electromagnetic type)



Note: Coupling loop may be shown inside or outside envelope as desired, but if inside it should be shown grounded.



2.94 (Contd)

(f) Emitting electrode

(1) Directly heated (filamentary) cathode

Note 1: Leads may be connected in any convenient manner to ends of the  provided the identify of the  is retained.



Note 2: A diagram for a tube having more than one heater or filament shall show only one heater or filament symbol  unless they have entirely separate connections. If a heater or filament tap is made, either brought out to a terminal or internally connected to another element, it shall be connected to another element, it shall be connected at the vertex of the symbol, regardless of the actual division of voltage across the heater or filament.

(2) Indirectly heated cathode

Note: Lead may be connected to either extreme end of the  or, if required, to both ends, in any convenient manner.



(3) Cold cathode (including ionically heated cathode)



(4) Photocathode



(5) Pool cathode

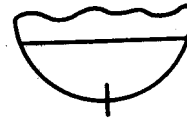

(6) Ionically heated cathode with provision for supplementary heating



(g) Envelope (shell)

Note: The general envelope symbol identifies the envelope or enclosure regardless of evacuation or pressure. When used with electron-tube component symbols, the general envelope symbol indicates a vacuum enclosure unless otherwise specified. A gas-filled electron device may be indicated by a dot within the envelope symbol.

(1) General

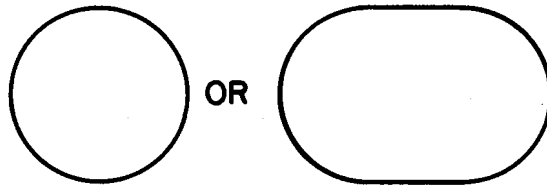

(2) Split envelope

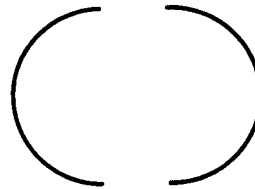

2.94 (Contd)

(3) Gas-filled

Note: The dot may be located as convenient.

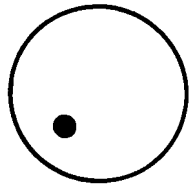

(h) Resonators (cavity type)

(1) Single-cavity envelope and grid-type associated electrodes

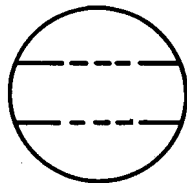

(2) Double-cavity envelope and grid-type associated electrodes

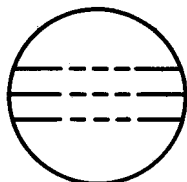

(3) Multicavity magnetron anode and envelope

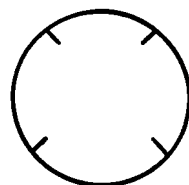

(i) Shield (against electric fields unless otherwise noted)

(1) Any shield against electric fields that is within the envelope and that is connected to an independent terminal

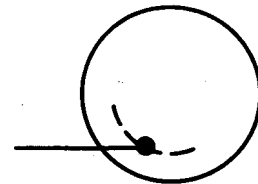

(2) Outside envelope

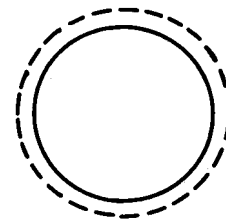

(3) Shield sleeve

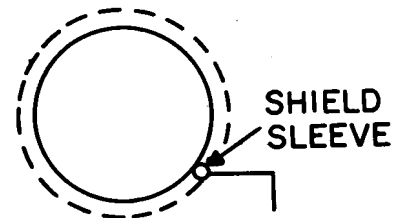

(j) Typical applications

(1) Cathode-ray tube

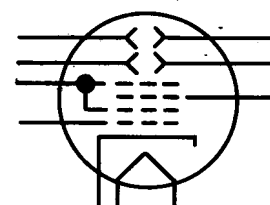

2.94 (Contd)

(2) Cold cathode tube

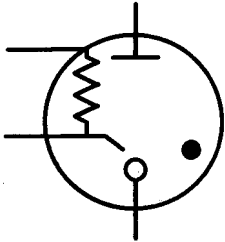

(4) Twin-triode tubes

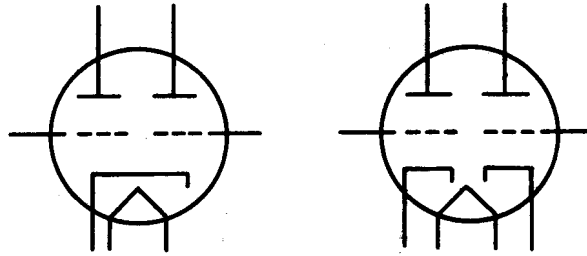

(DISCONTINUED)

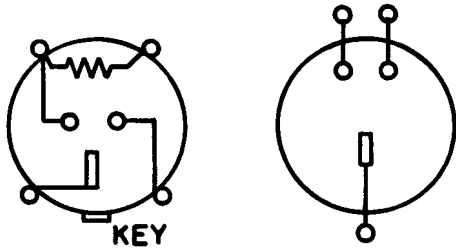

(5) Dual-gap surge protector tube

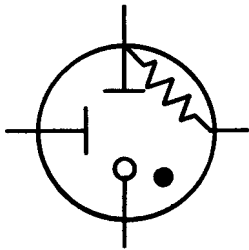
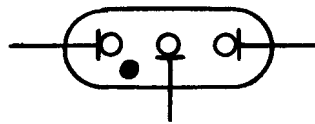

(6) Forward-wave traveling-wave-tube amplifier shown with four grids, having slow-wave structure with attenuation, external electromagnetic focusing, rf input and rf output coupling each by E-plane aperture to external rectangular waveguide

(3) Pentode tube

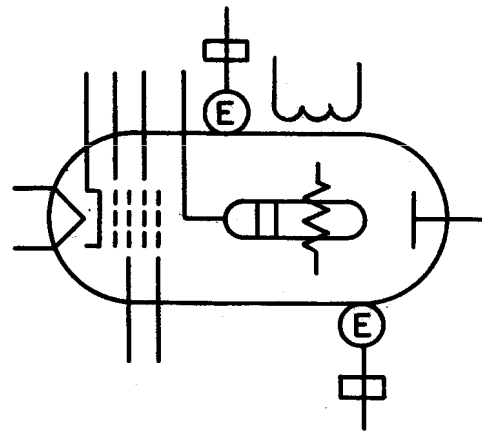
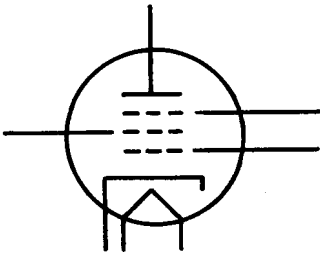

2.94 (Contd)

(7) Forward-wave traveling-wave-tube amplifier shown with four grids, having slow-wave structure with attenuation, external electromagnetic focusing, rf input and rf output coupling each by inductive coupling

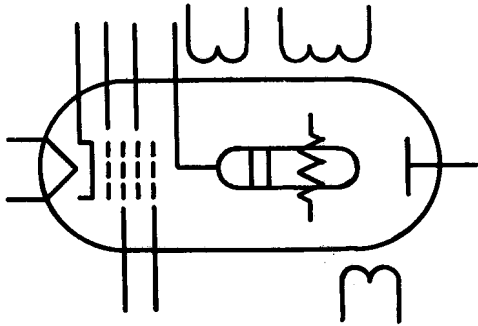

(8) Forward-wave traveling-wave-tube amplifier shown with four grids, having slow-wave structure with attenuation, external electromagnetic focusing, rf input and rf output coupling each by direct connection from slow-wave structure to a coaxial path

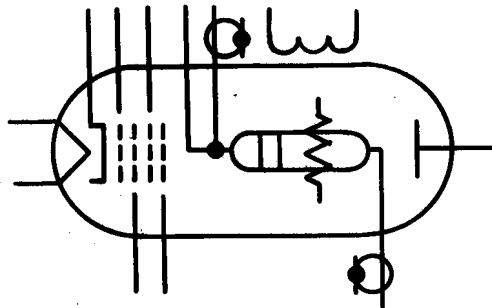

(9) Forward-wave traveling-wave-tube amplifier shown with four grids, having bifilar slow-wave structure with attenuation, electrostatic focusing, rf input and rf output coupling each by inductive coupling

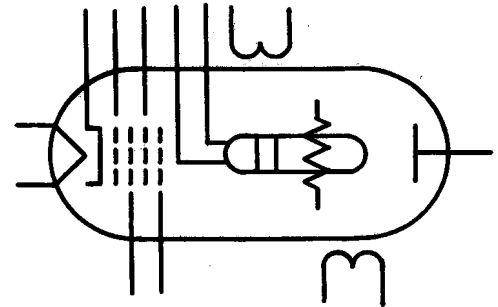

(10) Backward-wave traveling-wave-tube amplifier shown with two grids, having slow-wave structure, sole (beam-aligning electrode), magnetic focusing by external permanent magnet, rf input and rf output coupling each by E-plane aperture to external rectangular waveguide

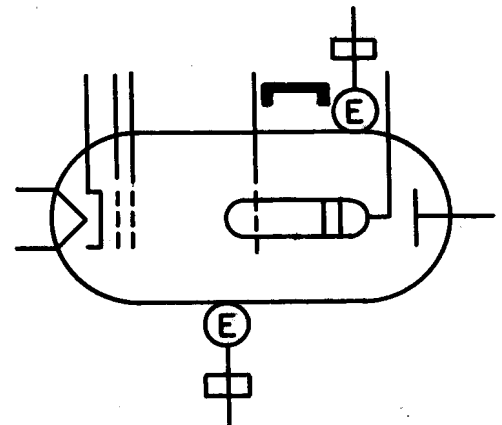

2.94 (Contd)

(11) Backward-wave traveling-wave-tube oscillator shown with two grids, having slow-wave structure, sole (beam-aligning electrode), magnetic focusing by external permanent magnet, rf output coupling by inductive coupling

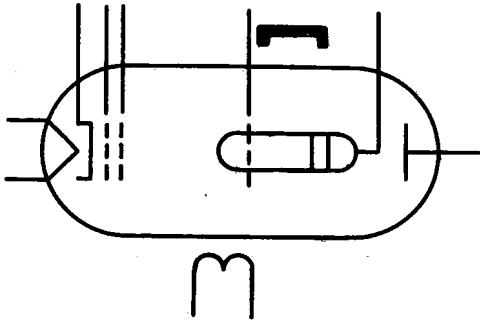

2.95 Unit, Crystal (piezoelectric)

Detector crystal

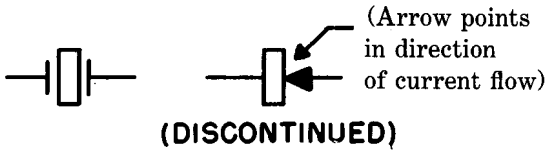

2.96 Varistor or Metallic Rectifier [also see diode, paragraph 2.73(1)]

Note: Arrow indicates the direction of low resistance to positive current flow.

(a) Asymmetrical type



(b) Symmetrical type



(DISCONTINUED)



2.97 Vibrator

(a) Typical shunt drive (contacts as required)

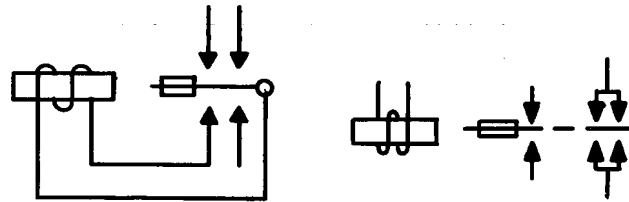
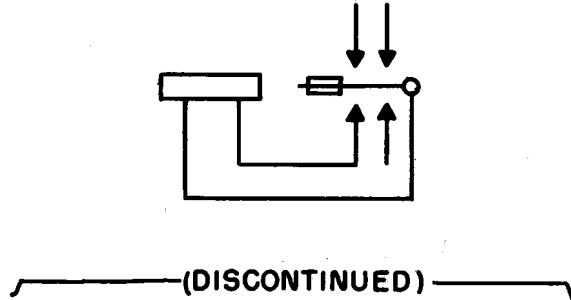

(b) Typical separate drive (contacts as required)

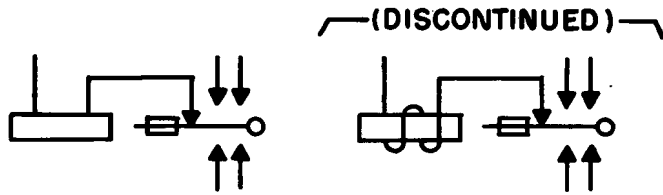

2.98 Waveguide Flanges

(a) Plain (rectangular waveguide)

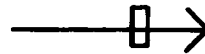

(b) Choke (rectangular waveguide)

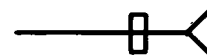

2.98 (Contd)

(c) Rectangular waveguide with mated plain and choke flanges with direct-current isolation (insulation) between sections of waveguide

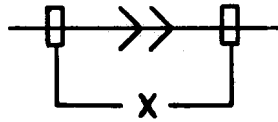

3. LOGIC SYMBOLS

3.01 Positive logic applies to symbols shown

Note: Truth tables are for reference only. Lead identifiers are for reference only except for flip-flops shown in 3(m).

(a) AND-Gate

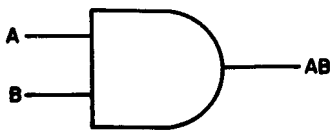

INPUT		OUTPUT
A	B	AB
0	0	0
0	1	0
1	0	0
1	1	1

(b) OR-Gate

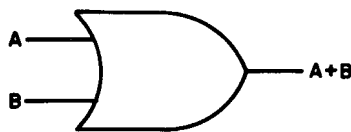

INPUT		OUTPUT
A	B	A+B
0	0	0
0	1	1
1	0	1
1	1	1

(c) Negation-Indicator

(d) NAND-Gate

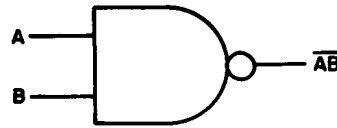

INPUT		OUTPUT
A	B	$\overline{AB} = \overline{A+B}$
0	0	1
0	1	1
1	0	1
1	1	0

Alternative symbol



(e) NOR-Gate

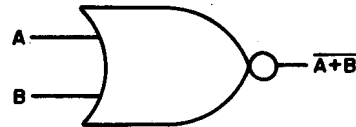

INPUT		OUTPUT
A	B	$\overline{A+B} = \overline{AB}$
0	0	1
0	1	0
1	0	0
1	1	0

ALTERNATIVE SYMBOL

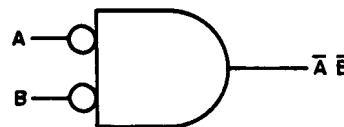

(f) Inversion-Obtained with single input gates

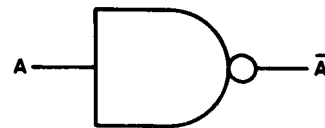

INPUT	OUTPUT
A	\overline{A}
0	1
1	0

Applied when one of several inputs of Nand gate is used.

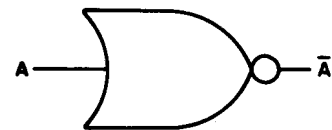

Applies when one of several inputs of a NOR gate is used.

3.01 (Contd)

(g) Inverter (Amplifier)

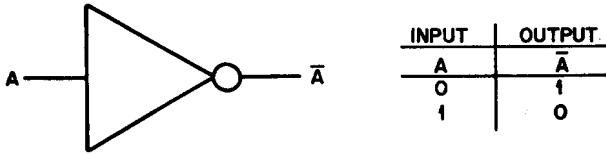

(h) OR-NOR gate

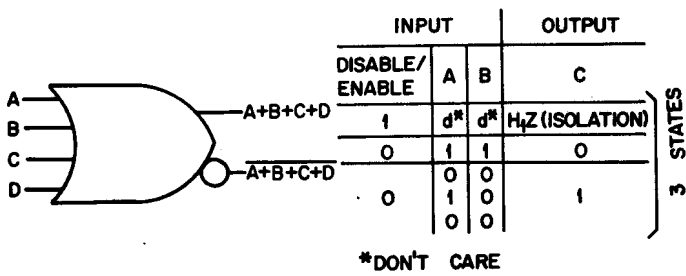

(i) "3-State" NAND gate

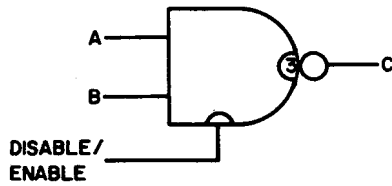

(j) Gate-Extension of inputs

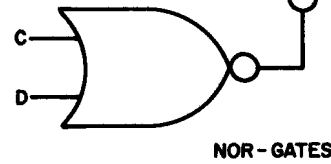
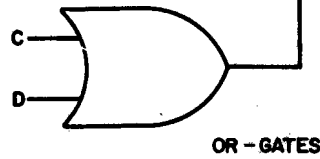
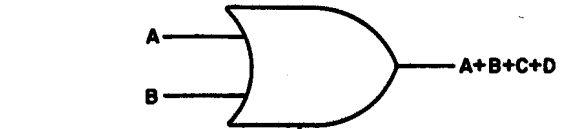
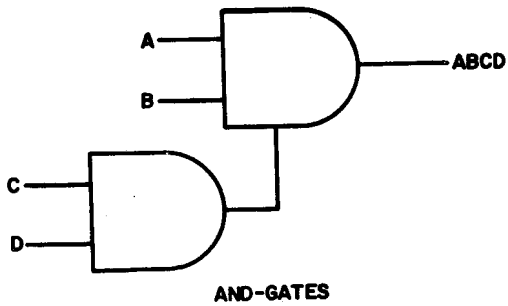

(k) Wired Logic

(1) Wired-AND

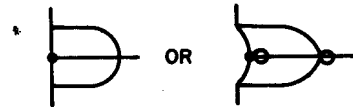

(2) Wired-OR

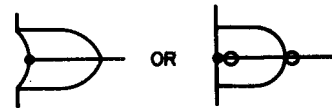

(3) Application of Wired-AND

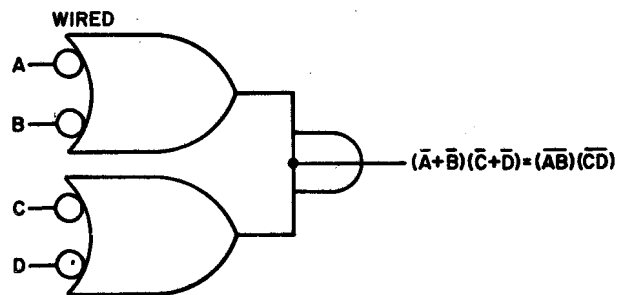

3.01 (Contd)

(4) Application of Wired-AND (Alternate)

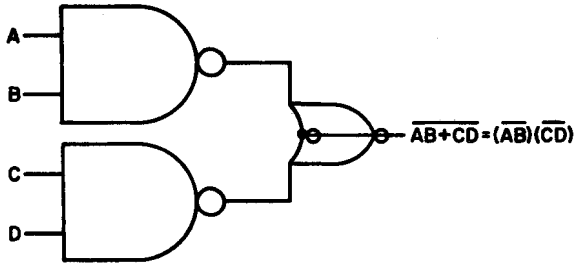

(l) Exclusive OR-Function

EXCLUSIVE OR-FUNCTION

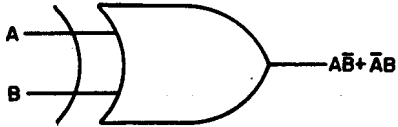

INPUT		OUTPUT
A	B	C
0	0	0
0	1	1
1	0	1
1	1	0

EXCLUSIVE NOR-(EQUIVALENCE FUNCTION)

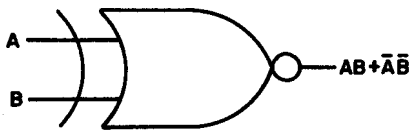

INPUT		OUTPUT
A	B	C
0	0	1
0	1	0
1	0	0
1	1	1

(m) FLIP-FLOPS (See note paragraph 3.)

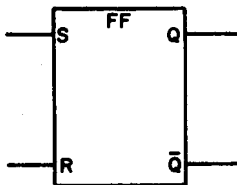

"RS"

INPUTS		OUTPUTS
R	S	Q Q̄
0	0	UNCHANGED
0	1	0 1
1	0	1 0
1	1	UNDEFINED

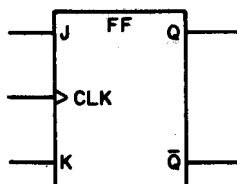

"JK" (CLOCKED)

INPUTS		OUTPUTS
J	K	Q Q̄
0	0	UNCHANGED
0	1	0 1
1	0	1 0
1	1	COMPLEMENTS

(n) Schmitt Trigger

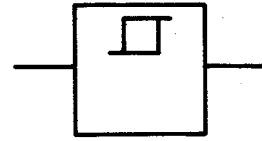

(o) Single Shot

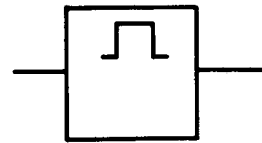

(p) Time delay

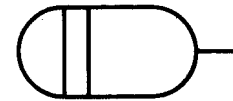

4. LIGHTWAVE TRANSMISSION SYMBOLS

4.01 Transmission Path Symbols and Application

(a) Lightguide recognition symbol

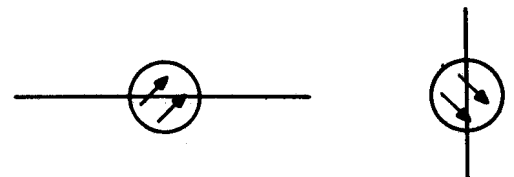

Note: Horizontal symbol is rotated clockwise for vertical orientation.

4.01 (Contd)

(b) Multiple-lightguide Cable

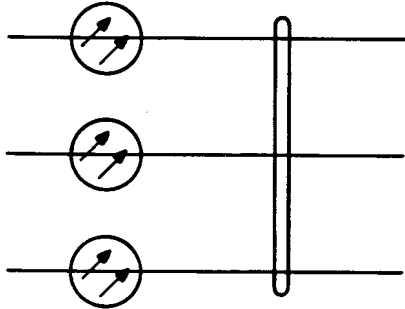

(c) Lightguide Splice

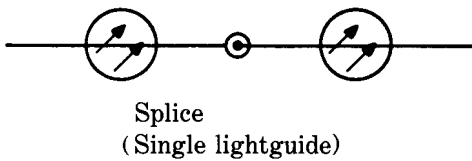

(d) Lightguide Connector

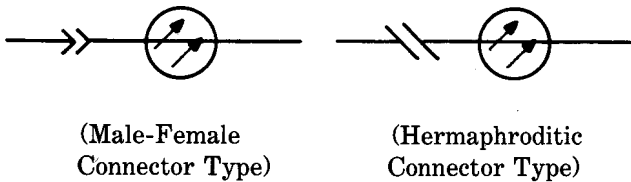

4.02 *Transmitting and Receiving System Components*

(a) Transmitter (LED type shown)

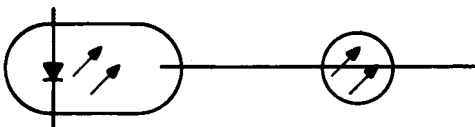

(b) Receiver (PIN type shown)

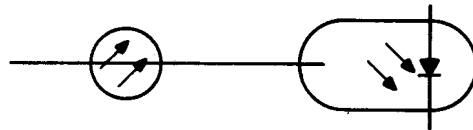

(c) Combined Transmitter-Monitor (Laser - PIN type shown)

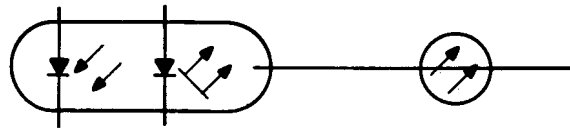

4.03 Example of Lightwave Symbols in Transmission System

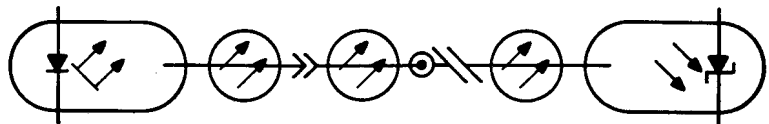

4.04 Device symbols

(a) Biconic sleeve connector

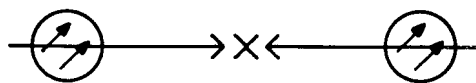

(b) Attenuator

(1) Fixed attenuation

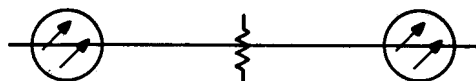

4.04 (Contd)

(2) Variable attenuation



(c) Couplers

(1) Directional coupler

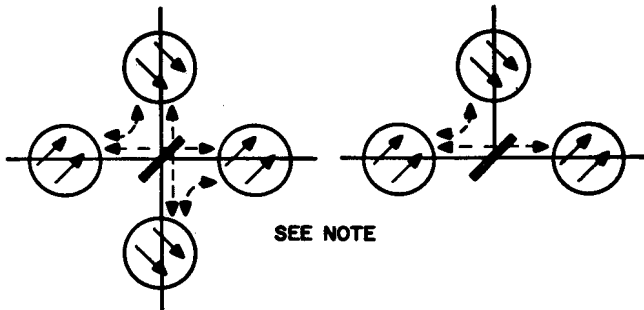

The ratio of transmission carried by the coupled paths would be indicated, when necessary, in parentheses adjacent to the coupling as shown below.

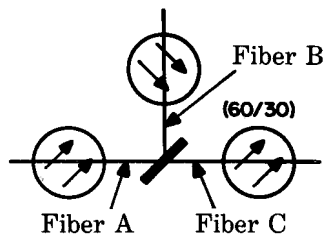

In this example, the interpretation would be that the coupler permits 60 percent coupling between fibers A and C (transmitted) and 30 percent coupling between fibers A and B (reflected). It should be noted that the total is not necessarily equal to a 100 percent.

(2) Nondirectional Coupling

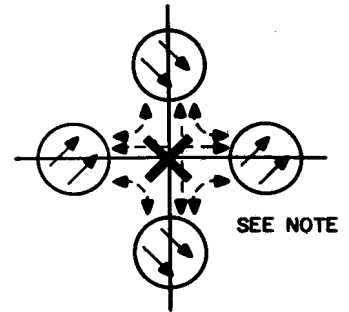

(d) Taps

(1) Directional

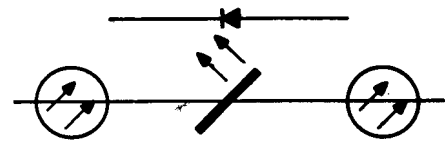

Single tap

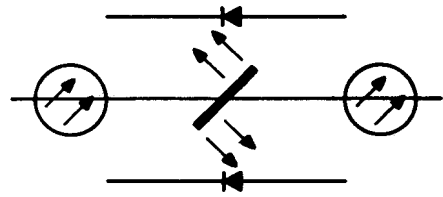

Multiple tap

(2) Nondirectional

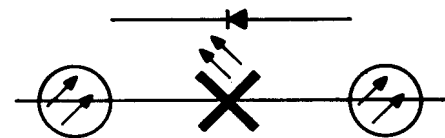

4.04 (Contd)

(e) Switch-Two Position-Manually Operated

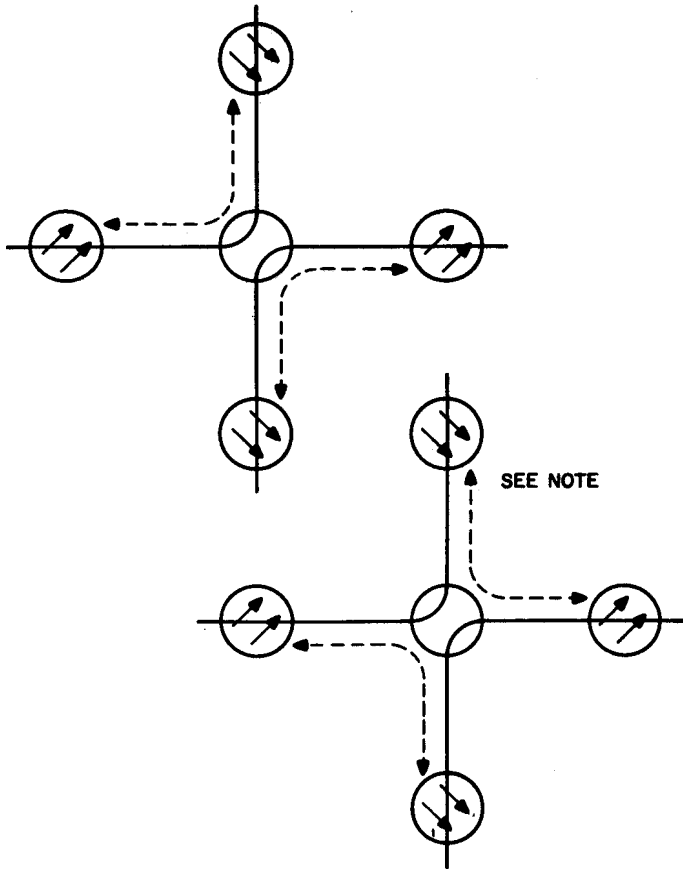

Note: Dash-lines in the above symbols are only for illustrating alternative transmission paths at the coupler and are not part of the symbol. The "mirror" symbol will be shown with a thick line to distinguish it from the lines representing the transmission paths.

(f) Remarks on Symbol Application

(1) The directional coupler symbol in part 2(a) is representative of circuit applications presently mainly used in the laboratory for fiber fault location apparatus. It is expected, however, that there will be general application for this symbology in transmission-path representations.

(2) A typical application for the tap symbol shown in paragraph 3(a) would be to represent such circuit functions as are involved in laser feedback and stabilization.

(3) Although at present, there is no actual application of the manually operated switch of part 4, it is expected that occasions will soon arise that will see a need for using the symbol in circuit documentation.

5. ALPHABETICAL INDEX

	Page		Page
		Buzzer	6
		AC buzzer	6
		AC-DC buzzer	6
		DC buzzer	6
Adjustability	2	Cable	36
Extrinsic	2	Coaxial	36
Inherent	2	Local	36
Special features	2	Switchboard	35
Alternator, Tone	3	Capacitor	7
Amplifier	3	Adjustable	7
Adjustable	3	Differential adjustable	7
Single line	3	Feed-through	7
Two outputs	3	Fixed	7
AND Logic	77	Polarized	7
Antenna	3	Circuit Breaker	6
Counterpoise	3	Circuit Discontinuity	7
General	3	Circuit Element	7
Horn	4	Circuit Return	7
Loop	4	Earth ground	7
Reflective	4	Chassis or frame	8
Attenuator	4	Common connection	8
Fixed	4	Clock, Electric	8
Variable	4	Clutch, Magnetic	32
Autotransformer	4	Coil	8
Battery and Potential Supply	4	Heat coil	8
CEMF cells	4	Operating coil	9
Multicell battery	4	Conductor	34
One cell	4	Connector	9
Potential supply	5	Coaxial connector	10
Solar cell	5	Connector commonly used for power supply (convenience outlets and mating connectors)	12
Bell	5	Cord tip-type connector	14
AC bell	5	Female element	9
AC-DC bell	5	Hermaphroditic element	9
DC bell	5	Male element	9
Binding Post	38	Separable connectors hermaphroditic	10
Block, Protector	23	Separable connectors male and female	9
Boundary, Mechanical Grouping	34	Switchboard-type connectors (jacks and plugs)	10
Breaker, Circuit	6		
General	6		
Toggle switch-type	6		

	Page		Page
Contact	14		
Fixed	14	Dial	20
Moving	14		
Break- and make-contacts	15	Diode (semiconductor device)	52
Contactor	15	Direction of flow of power, signal, or information	20
Relay (armature-type)	15	One-way	20
Solenoid-type	16	Both ways	20
Application on Power Systems	16		
Core	16	Directional Coupler	17
For relays, magnets, etc	16		
Magnetic (general)	17	Discontinuity	20
Magnetic core switching element (mirror symbol)	17	Equivalent series element—general	20
Relay core with frame ground	17	Equivalent shunt element—general	21
Counterpoise	3	Drop	22
		Electrically restored drop	22
		Manually restored drop	22
Coupler, Directional (microwave circuitry)	17	Electromagnet	22
E-plane aperture coupling	17		
Loop coupling, 30-dB attenuation	17	Electron Tube	71
Probe coupling, 30-dB attenuation	17		
General	17	Element, Circuit	7
Resistance coupling	17		
Coupling (microwave circuitry)	17	Element, Thermal	65
Coupling by aperture with an opening of less than full waveguide size	18	Engine-generator Set	56
Coupling by loop	17		
Coupling by probe	18	Flip-flop	79
Cross-connection Wires	35	Fork, Tuning	22
Crystal Unit	76	Fuse	22
Delay Function (slow-wave structure)	19	Alarm-type fuse	22
General	19	Alarm-type fuse on bus bar	23
Tapped delay function	19	Fuse in safety-type holder	23
Device Symbols	80	Fuse (no alarm)	22
Attenuator	80	Gap (lightning arrestor)	23
Biconic sleeve connector	80	General	23
Couplers	81	Carbon block	23
Taps	81	Gates	77
Switch-Two position	82	AND	77
Diagram, Keytop	19	NAND	77
Lever-type	19	"3 STATE" NAND	78
Pushbutton-type	20	OR	77
Turnbutton-type	19	OR-NOR	77
Switch top	19	NOR	77
		Exclusive OR	79

	Page		Page
Generator (Machine, rotating)	31	Circulator, fixed direction	26
Ground Chassis or Frame Connection	8	Hybrid, circular	26
Earth	7	Hybrid (general)	26
Common Connection	8	Hybrid, junction	26
Grouping, Mechanical	34	Tee or Wye	26
Handset	23	Key	27
3-conductor handset	23	Both halves of key actuated with	
4-conductor handset	23	single throw of lever	28
4-conductor handset with		Jack-type	28
push-to-talk switch	24	Locking lever-type	29
Headset, Operator	24	Nonlocking lever-type	27
Heat Coils	8	Plunger-type	28
Heating Resistor	47	Plunger—turnbutton-type	28
Horn or Howler	24	Selector-type	30
Inductance	24	Telegraph-type	29
Induction Coil	68	Turnbutton-type	29
Inductor	24	Keytop Diagram	30
Adjustable	24	Lamp	30
Continuously adjustable	24	Double filament ballast or resistance	
General	24	lamp	30
Saturable reactor	24	Glow-type	30
Shunt	24	Illuminating-type	30
With magnetic core	24	Single-filament ballast or resistance	
With taps	24	lamp	30
Instruments and Meters	25	Switchboard-type	30
Abbreviations	25	Lasers, Junction	53
Without shunt	25	Lightwave Transmission Symbols	79
With shunt	25	Linkage, Mechanical	34
Interrupter	25	Logic Symbols	77
Motor-driven type interrupter	25	AND-Gate	77
Ringing interrupter	25	Gate-Extension of inputs	78
Isolator	25	Exclusive OR-function	79
Jacks	26	Flip-flop	79
Junctions (microwave transmission)	26	Inversion	77
Application: Waveguide and coaxial		NAND-gate	77
couplings	26	Negation-indicator	78
		NOR-gate	77
		OR-gate	77
		OR-NOR gate	78
		Inverter	78
		Schmitt trigger	79
		Single shot	79
		Time delay	79
		Wired Logic	78
		3-state NAND gate	79
		Looping (detached contact)	37

	Page		Page
Loudspeaker, Horn, Howler, Telephone Receiver (tone ringer)	30	Negation	77
Identification of loudspeaker parts	30	Network	33
Machine, Rotating	31	Network used as contact protection	33
Direct-current compound motor or 2-wire generator or stabilized shunt motor	32	Typical network	33
Direct-current series motor or 2-wire generator	31	Open (microwave circuitry)	34
Direct-current shunt motor or 2-wire generator; with commutating or compensating field winding or both	32	OR Logic	77
Generator (general)	31	Oscillator	34
Hand-type generator	32	Path (transmission), Conductors, Wiring, etc	34
Motor (general)	31	Cable, coaxial	36
Separately excited direct-current generator or motor	31	Cable, local	36
Separately excited direct-current generator or motor; with commutating or compensating field winding or both	31	Cable, general, switchboard	35
Squirrel-cage induction motor or generator, split-phase induction motor or generator, or repulsion motor	32	Cross-connection wires	35
Synchronous motor or generator with both ends of each phase brought out	32	Crossover (no junction)	37
Synchronous motor or generator with neutral brought out	32	4-wire twist	35
Winding symbols	31	Individually shielded wires with shields connected together to ground	36
Magnetic Clutch	32	Intentional isolation of direct- current path (coaxial or waveguide)	38
Message Register	39	Junction, single	37
Meter	33	Leads requiring segregation for crosstalk control, etc	36
Microphone	33	Leads run from terminal to terminal	36
Mode Suppression (microwave circuitry)	57	Line thickness and use on drawings	34
Mode Transducer (microwave circuitry)	68	Local cable or loose wiring	36
Motion	33	Looping (detached contact)	37
Rotation, one direction	33	More-than-one lead representation	34
Rotation, both directions	33	Multiple connection	35
Translation, one direction	33	Optional or alternative paths	34
Translation, both directions	33	Paired twisted wires	34
Motor (machines, rotating)	33	Paired wires with special twist	34
		Quad (two pairs twisted)	35
		Shielded single wires	36
		Single junction	37
		Spliced wires	37
		Stripline	36
		Triple twisted wires	34
		Typical paired and shielded wires	37
		Wires in same shield	37
		Waveguide, transmission path	37
		Permanent magnet	38
		Phase Shifter	56
		Piezoelectric, Crystal Unit	76
		Plug	88

	Page		Page
Point, Test	38	Heating	47
Polarity (mark for showing instantaneous direction of current)	38	Relay spool-type resistor	46
Post, Binding	38	Resistor with two windings, having one terminal common to both windings	46
Potentiometer	46	Tapped windings	46
Protector Block	23	Resonator (excluding piezoelectric and magnetostriction devices)	47
Receiver	38	Rheostat or Adjustable Resistor	46
Double headset	38	Ringer, Telephone	47
General	38	Rotary joint	47
Single headset	39	Circular waveguide type in rectangular waveguide system	47
Receptacle	39	Coaxial type in rectangular waveguide system	47
Rectifier, Metallic	39	General	47
Region (semiconductor devices)	49	Rotation	33
Register, Message	39	Saturable Reactor	24
Regulator	39	Selector	48
Relay	39	10-terminal rotary-type	48
Ammeter-type	45	22-terminal rotary-type	48
Double contact-type	45	44-terminal rotary-type	49
Double-wound relay with break- and make-before-break contacts	40	Semiconductor Devices	49
Mechanically locking and electrically releasing relay	44	Application; two terminal devices	52
Mercury-contact-type	46	Application; three or more terminal devices	53
Multicontact	42	Collector on semiconductor region	50
Polarized (telegraph)	44	Gate control electrode	50
Relay in normally energized state	41	Insulated gate	50
Relay with noninductive winding and transfer contacts	40	N emitter or P region	50
Relay with preliminary make-contact	40	Enhancement-type semiconductor region	49
Sensitrol-type	45	N emitter on P region	49
Single-wound relay with make-contact	40	N region on P region	49
Solenoid-type	44	P emitter on N region	50
Voltage-type	46	P region on N region	49
Wire-spring	41	Semiconductor region with one ohmic connection	49
Repeating Coil	68	Semiconductor region with a plurality of ohmic connections	49
Resistor	46	Transition between regions of dissimilar conductivity types either P to N or N to P	50
Adjustable (rheostat and potentiometer)	46	Special Properties	50
Carbon or wire	46	Sensor, Ferrod	56

	Page		Page
Set, Engine-Generator	56	Telephone Ringer	47
Shifter, Phase	56	Terminals	64
Short (microwave circuitry)	56	Coaxial terminal	65
Transmission path terminated in a short	56	Component terminal	64
Movable short	56	Cross-connection terminal	65
Signal	57	Spade tip	65
Sounder	57	Terminal strip or terminal punching	64
Chime, tone-bar, etc, type sounder	57	Terminal Strip	57
Telegraph-type sounder	57	Test Point	38
Special properties	50	Thermal Element	65
Breakdown device	50	Actuating device	65
Capacitive device	51	Thermal cutout; flasher	65
Nonionizing electromagnetic radiation	50	Thermal relay	66
Temperature dependence	52	Thermostat (rising temperature)	65
Tunneling device	52	Thermostat (lowering temperature)	65
Saturable (general)	51	Thermostat with heater unit	66
Storage device	51	Thermistor	67
Surge protector	51	Directly heated thermistor	67
Strip, Terminal	57	Indirectly heated thermistor	67
Suppression, Mode	57	Thermocouple	67
Switch	58	Directly heated thermocouple	67
Coaxial or waveguide (any number of transmission paths may be used)	58	Indirectly heated thermocouple	67
Cover- or door-type	61	Thyratron (solid state)	67
Crossbar selector-type	62	Timer	68
Knife	59	Tone Alternator	3
Momentary pushbuttons switch	60	Transducer, Mode	68
Rotary-type (high voltage)	62	Transformation for tapers and step transformers without mode change	68
Rotary-type (selector)	63	Application: Transformer with mode suppression	68
Screw Switch	62	Transformer	68
Sequence-type switch	59	Adjustable mutual conductor	69
Slide switch	64	Adjustable tap-type autotransformer	70
Step-by-step system selector-type switch	58	Autotransformer	70
Switch top diagram	64	Current	70
Toggle, combination locking and momentary	61	General	68
Toggle, locking	61	Hybrid type	70
Toggle, momentary	60	Load-ratio control autotransformer	70
TOUCH-TONE pushbutton	64	Load-ratio control transformer with taps	69
Switchhook	64		

	Page		Page
Multiple winding	70	Varistor or Metallic Rectifier	76
With adjustable inductance wiring	69	Asymmetrical type	76
With magnetic core	69	Symmetrical type	76
With magnetic core and shield	69	Vibrator	76
With separately adjustable inductance in each winding	69	Typical separate drive	76
With taps	69	Typical shunt drive	76
Transistor (semiconductor device)	49	Waveguide	37
Transmission Path	79	Waveguide Flange	76
Transmitter	70	Winding (relay)	8
Tubes, Electron	71	Heat Coil	8
Basic parts	71	Inductive series windings internally connected	9
Typical applications	71	Inductive winding for relays, electromagnets, etc	9
Unit, Crystal (piezoelectric)	76	Inner end for windings of relays, electromagnets, etc	9
Variability	2	Noninductive winding	9
		Wiring	34