

NAVSHIPS 94200.4

Directory of Electronics Test Equipment  
Section 4.6 Impedance and Standing Wave  
Ratio Equipment

April 1958

# INSULATION TEST SET AN/PSM-1, 1A, 2, 2A

## ELECTRICAL AND MECHANICAL CHARACTERISTICS

**METER RANGE**  
 AN/PSM-1, 1A: 0 to 100 meg.  
 AN/PSM-2, 2A: 0 to 1000 meg.  
**FULL SCALE DEFLECTION**  
 AN/PSM-1, 1A: 0.90 ma.  
 AN/PSM-2, 2A: 90 ua.  
**TESTING VOLTAGE:** 500 v DC.  
**GENERATOR DATA**  
 TYPE: Hand-crank.  
 AVERAGE CRANK SPEED: 170 rpm.

## MANUFACTURER'S OR CONTRACTOR'S DATA

Holtzer-Cabot Division, National Pneumatic Company, Inc., Boston, Mass.  
 Contract NObs-53333, dated 11 November 1950 (AN/PSM-1, 2).  
 Contract N155-24020, dated 26 June 1956 (AN/PSM-1A, 2A).  
 Contract N155s-22116, dated 7 March 1956 (AN/PSM-1A, 2A).  
 Contract N155s-21729, dated 20 June 1956 (AN/PSM-1A, 2A).  
 Contract N155s-23342, dated 14 May 1956 (AN/PSM-1A, 2A).  
 Contract N155-24367, dated 3 August 1956 (AN/PSM-1A, 2A).

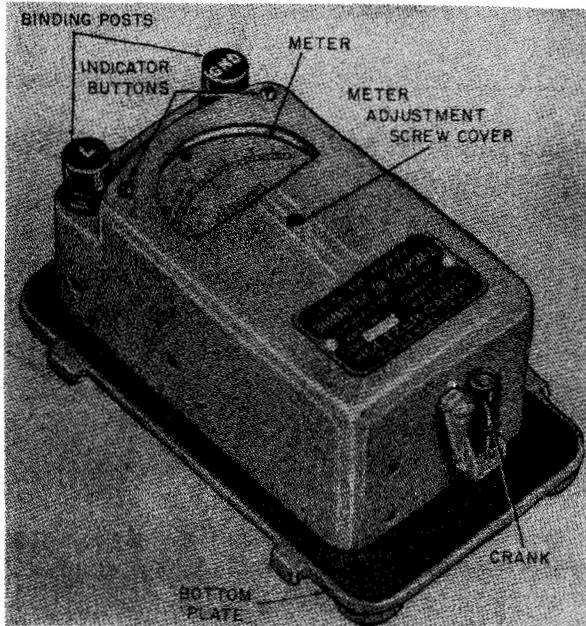

Insulation Test Set AN/PSM-1, 1A, 2, 2A

## FUNCTIONAL DESCRIPTION

The AN/PSM-1, AN/PSM-1A, AN/PSM-2, and AN/PSM-2A are self-contained, portable test sets designed to measure insulation resistance. The AN/PSM-1 and AN/PSM-1A will measure insulation resistance from 0 to 100 megohms, while the AN/PSM-2 and AN/PSM-2A will measure insulation resistance from 0 to 1000 megohms. The AN/PSM-1 and AN/PSM-2 differ from the AN/PSM-1A and AN/PSM-2A mainly in that a selenium rectifier in the circuits of the AN/PSM-1A and AN/PSM-2A has replaced the rectifier tube in the AN/PSM-1 and AN/PSM-2 circuits.

No field changes in effect at time of preparation (7 October 1957).

## RELATION TO OTHER EQUIPMENT

The Ohmmeter ZM-13/PSM-1 and ZM-13A/PSM-1 are essentially the same as Navy Model OCW (NT-60142) Insulation Resistance Tester.

## TUBE AND/OR CRYSTAL COMPLEMENT

AN/PSM-1, 2  
 (2) 5517\*  
 Total Tubes: 2 (AN/PSM-1, 2)  
 NOTE: \*-1 each is spare in spare tube socket.  
 AN/PSM-1A, 2A  
 Total Tubes: 0 (AN/PSM-1A, 2A)

## REFERENCE DATA AND LITERATURE

NAVSHIPS 91430: Technical Manual for Insulation Test Sets AN/PSM-1 and AN/PSM-2.  
 NAVSHIPS 91608C: Technical Manual for Insulation Test Sets AN/PSM-1A and AN/PSM-2A.

<b>TYPE CLASSIFICATION</b>
<b>DESIGN COGNIZANCE</b> BUSHIPS
<b>PROCUREMENT COGNIZANCE</b>
<b>STOCK NO.</b>
<b>R.D.B. IDENT. NO.</b> 6.1.1

## SHIPPING DATA

NUMBER OF BOXES	CONTENTS AND IDENTIFICATION	VOLUME (Cu.Ft.)	OVERALL DIMENSIONS (inches)	WEIGHT PACKED (lbs.)
1	Insulation Test Set AN/PSM-1 or AN/PSM-1A or AN/PSM-2 or AN/PSM-2A	0.37	7-1/8 X 9-7/16 X 9-1/2	8.5

Test-Impedance and Standing Wave Ratio

AN/PSM-1, 1A, 2, 2A

INSULATION TEST SET

April 1958

EQUIPMENT SUPPLIED DATA						
QUANTITY PER EQUIPT				NAME AND NOMENCLATURE	OVERALL DIMENSIONS (inches)	WEIGHT (lbs.)
AN/PSM-	1A	2	2A			
1	1	1	1	Carrying Cover CY-( )/PSM	5 X 6-1/4 X 7-1/4	2.0
1				Ohmmeter ZM-13/PSM-1	3-21/32 X 4-5/8 X 7-1/4	3.5
	1			Ohmmeter ZM-13A/PSM-1	3-21/32 X 4-5/8 X 7-1/4	3.5
		1		Ohmmeter ZM-14/PSM-2	3-21/32 X 4-5/8 X 7-1/4	3.5
			1	Ohmmeter ZM-14A/PSM-2	3-21/32 X 4-5/8 X 7-1/4	3.5
1	1	1	1	Test Lead, Black CX-1925/U	121-3/4 lg	0.25
1	1	1	1	Test Lead, Red CX-1926/U	121-3/4 lg	0.25
1	1	1	1	Neon Lamp	1/4 dia X 1	
1		1		Rectifier Tube	3/4 dia X 2-1/4	0.06
1		1		Technical Manual NAVSHIPS 91430	3/8 X 4-1/4 X 6-3/8	0.25
	1		1	Technical Manual NAVSHIPS 91608C	3/8 X 4-1/4 X 6-3/8	0.25

April 1958

Test-Impedance and Standing Wave Ratio

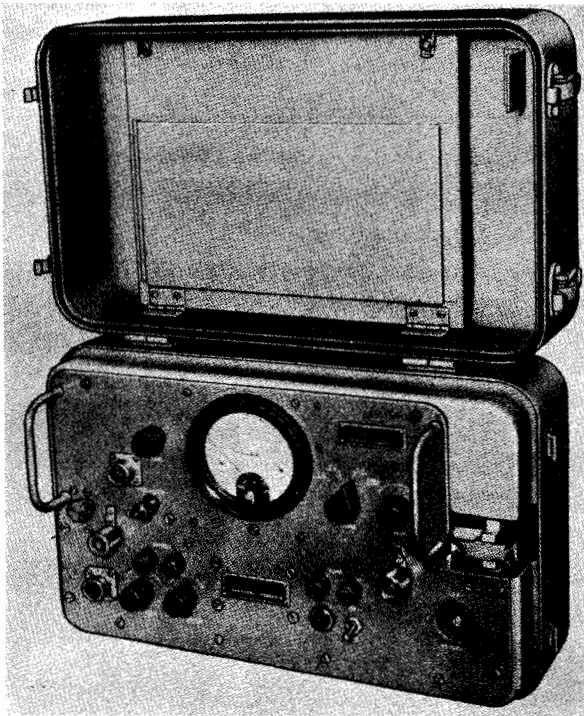
**RADAR TEST SET****AN/UPM-12***Radar Test Set AN/UPM-12***FUNCTIONAL DESCRIPTION**

The AN/UPM-12 (Sperry Model 539) is a direct reading reflectometer type meter designed to measure VSWR of apparatus operating in the frequency range of 8.5 to 9.6 kmc. The test set is intended for laboratory or field use and may be attached to a system, or have smaller apparatus attached to it. It can be used with two wave-guide sizes, RG-51/U and RG-52/U.

The test set consists of two major assemblies, an R-F Bridge Assembly IM-10A/UPM-12 and a Power Supply Assembly PP-1227/UPM-12. The R-F Bridge Assembly is removed from the case during operation, can be operated at a distance of up to 12 feet from the rest of the test set. The RF Bridge Assembly contains an adjustable leg and a special flange clamp for facilitating connections in various applications.

The test set also serves as a signal source with a square-wave modulated output of approximately 125 microvolts.

No field changes in effect at time of preparation (18 March 1958)

**RELATION TO OTHER EQUIPMENT**

This equipment is identical with Sperry Gyroscope Model 539.

Equipment Required but not Supplied: (1) Frequency Meter.

**ELECTRICAL AND MECHANICAL CHARACTERISTICS**

FREQUENCY RANGE: 8.5 to 9.6 kmc.

MODULATING FREQUENCY: 1300 to 1500 cps.

VSWR RANGES AND ACCURACY

1.05 to 1.3,  $\pm 5\%$ .

1.3 to 2.0,  $\pm 10\%$ .

2.0 to 3.0,  $\pm 10\%$ .

High (3.0 to 10.0), Uncalibrated.

AMPLIFIER BANDWIDTH: 150 cps  $\pm 15$  cps at 1400 cps  $\pm 50$  cps center frequency (at half power).

AMPLIFIER GAIN: 75 db minimum on 1.3 range.

R.F. POWER OUTPUT: 125 microwatts approx.

POWER SUPPLY DATA

RIPPLE: Less than 5 millivolts.

REGULATION: Within 1%.

POWER REQUIREMENTS: 105 to 125 v, 50 to 1000 cps, 76 W at 0.9 amp.

**MANUFACTURER'S OR CONTRACTOR'S DATA**

Sperry Gyroscope Co, Div of the Sperry Corp, Great Neck, N.Y.

Contract NObsr 64615, dated 26 Jan 1955.

**TUBE AND/OR CRYSTAL COMPLEMENT**

(1) 2K25

(1) 12AT7

(1) 5751

(2) 6AU6

(1) 6AV6

(1) 5Y3GT

(1) 6X4

(1) 6AQ5

(1) 5651

(2) OB2

(1) 12AU7

Total Tubes: (13)

(1) 1N23B

(4) 1N43

Total Crystals: (5)

**REFERENCE DATA AND LITERATURE**

NAVSHIPS 92610: Instructions and Parts Breakdown for Radar Test Set AN/UPM-12 (Sperry Model 539).

TYPE CLASSIFICATION
DESIGN COGNIZANCE
PROCUREMENT COGNIZANCE
STOCK NO.
R.D.B. IDENT. NO.



Test-Impedance and Standing Wave Ratio

AN/UPM-12

RADAR TEST SET

April 1958

## EQUIPMENT SUPPLIED DATA

QUANTITY PER EQUIPT	NAME AND NOMENCLATURE	OVERALL DIMENSIONS (inches)	WEIGHT (lbs.)
1	Radar Test Set AN/UPM-12 (in combination case) consists of:	10-3/32 X 11-3/4 X 19-3/16	
1	RF Bridge Assy IM-10A/UPM-12		
1	Power Supply Assy PP-1227/UPM-12		
1	Calibrated Mismatch DA-111/UPM-12	1-5/8 X 1-5/8 X 2-11/16	
1	Waveguide Adapter UG-153/U	1-7/16 X 1-19/32 X 1-19/32	
1	Interconnecting Cable Assy CX-3115/U	144 lg	
1	Power Cable Assy CX-237/U	144 lg	
3	Indicator Lamp NE-51		
2	Crystal Diode, 1N26		
3	Fuse type AGC3		
1	Allen Wrench		
1	Handbook of Instructions		

28 May 1962

Cog Service: USN

FSN:

STANDING WAVE RATIO INDICATOR AN/UPM-79

Functional Class: 6.2.2.

USA

USN

USAF

**TYPE CLASS:**

Used by

**MANUFACTURER'S NAME/CODE NUMBER:** Raytheon Mfg Co., (49956).

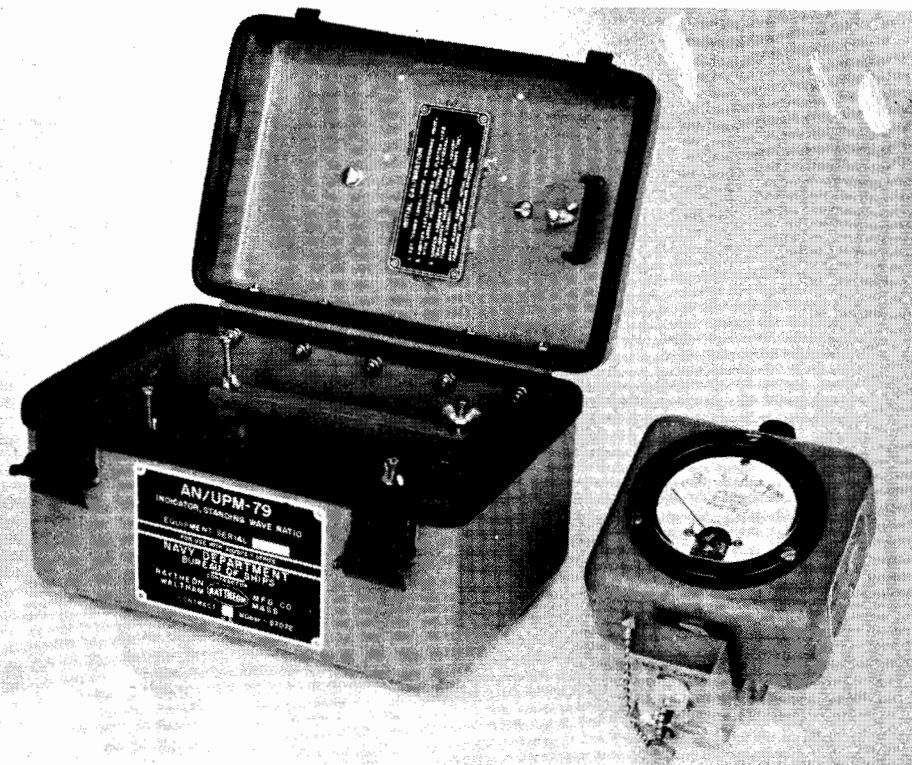

*Standing Wave Ratio Indicator AN/UPM-79*

**FUNCTIONAL DESCRIPTION:**

Standing Wave Ratio Indicator AN/UPM-79 is designed for temporary insertion into the slotted section of Directional Coupler CU-245/U to provide measurement of the overall standing wave ratio of the waveguide and the antenna system, and a rough indication of transmitter power level.

No field changes in effect at time of preparation (1 March 1962).

**TECHNICAL CHARACTERISTICS:**

FREQUENCY RANGE: 6275 to 6575 mc.

VSWR: 1.6.

**RELATION TO OTHER EQUIPMENT:** None.

---

**AN/UPM-79 STANDING WAVE RATIO INDICATOR**

---

EQUIPMENT REQUIRED BUT NOT SUPPLIED: None.

**MAJOR COMPONENTS**

---

QTY	ITEM	STOCK NUMBERS	DIMENSIONS (INCHES)	WEIGHT (LBS)
1	Standing Wave Ratio Indicator AN/UPM-79 includes:			
1	Indicator, Standing Wave Ratio IM-120/UPM-79		6-3/4 x 7-1/4 x 9-1/4	6
1	Case, Indicator CY-1978/UPM-79			

---

**REFERENCE DATA AND LITERATURE:**

NAVSHIPS 91958A: Technical Manual for Radar Set AN/SPS-5B.

---

**TUBE, CRYSTAL AND/OR SEMI-CONDUCTOR DATA:**

TUBES: None used.

CRYSTALS: None used.

SEMI-CONDUCTORS: (1) 1N25

**SHIPPING DATA**

---

PKGS	VOLUME (CU FT)	WEIGHT(LBS)
------	----------------	-------------

---

**PROCUREMENT DATA**

PROCURING SERVICE: USN  
SPEC &/OR DWG:

DESIGN COG: USN, BuShips

---

CONTRACTOR	LOCATION	CONTRACT OR ORDER NO.	APPROX. UNIT COST
Raytheon Mfg Co.	Waltham, Mass.	N0bsr-57072, 7 November 1951	\$246.00

---

12 February 1963

Cog Service: USAF FSN:

RADIO TEST SET AN/URM-30

Functional Class: 6

USA

USN

USAF

TYPE CLASS:

Std

Std

MANUFACTURER'S NAME/CODE NUMBER: Hoffman Radio Corporation, (28959).

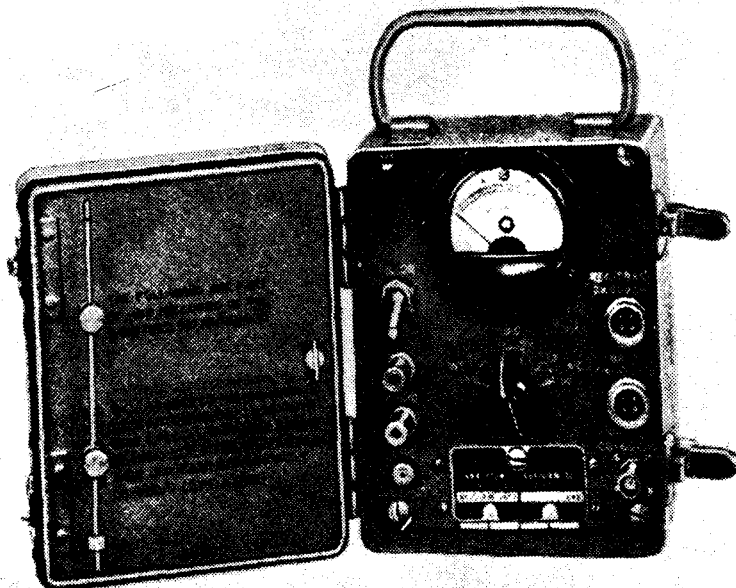

*Radio Test Set AN/URM-30*

**FUNCTIONAL DESCRIPTION:**

Radio Test Set AN/URM-30 is a portable "go-no-go" analyzing equipment that generates a modulated rf signal. It is used in measuring audio output of receivers and rf power output of transmitters.

No field changes in effect at time of preparation (7 June 1962).

**TECHNICAL CHARACTERISTICS:**

POWER REQUIREMENTS: 1.05 to 1.34 v, 75 to 147 v dc.

FREQUENCY RANGE: 120 to 130 mc; 240 to 260 mc.

FREQUENCY ACCURACY: Porm 0.008%.

MODULATION DATA: Amplitude modulated at 900 to 1500 cps; 20%.

VOLTAGE OUTPUT: 100 uv min.

---

**AN/URM-30 RADIO TEST SET**

---

OUTPUT IMPEDANCE: 51.5 ohms.  
TEMPERATURE RANGE: M40 deg C to P55 deg C.

RELATION TO OTHER EQUIPMENT: None.

EQUIPMENT REQUIRED BUT NOT SUPPLIED: None.

---

**MAJOR COMPONENTS**

---

QTY	ITEM	STOCK NUMBERS	DIMENSIONS (INCHES)	WEIGHT (LBS)
1	Radio Test Set AN/URM-30 includes:			
1	Analyzer TS-684/URM-30		3 x 5 x 6	2
1	Antenna AT-293/URM-30			
1	R.F. Cable Assy CG-606/U		30 lg	
2	Cable CX-1093/U		30 lg	

---

---

**REFERENCE DATA AND LITERATURE:**

TO 33A1-7-8-1: Operation and Service Instructions for Radio Test Set AN/URM-30.  
TO 33A1-7-8-4: Illustrated Parts Breakdown for Radio Test Set AN/URM-39.

---

---

**TUBE, CRYSTAL AND/OR SEMI-CONDUCTOR DATA:**

TUBES: (1) 385A

CRYSTALS: None used.

SEMI-CONDUCTORS: None used.

---

---

**SHIPPING DATA**

---

PKGS	VOLUME (CU FT)	WEIGHT (LBS)
1	0.213	5.5

---

---

**PROCUREMENT DATA**

---

PROCURING SERVICE: USAF  
SPEC &/OR DWG: MIL-R-6372

DESIGN COG: USAF, WADC

---

CONTRACTOR	LOCATION	CONTRACT OR ORDER NO.	APPROX. UNIT COST
Hoffman Radio Corp.	Los Angeles, Calif.	AF33(038)5603	\$94.43

---

4.6 AN/URM-30: 2

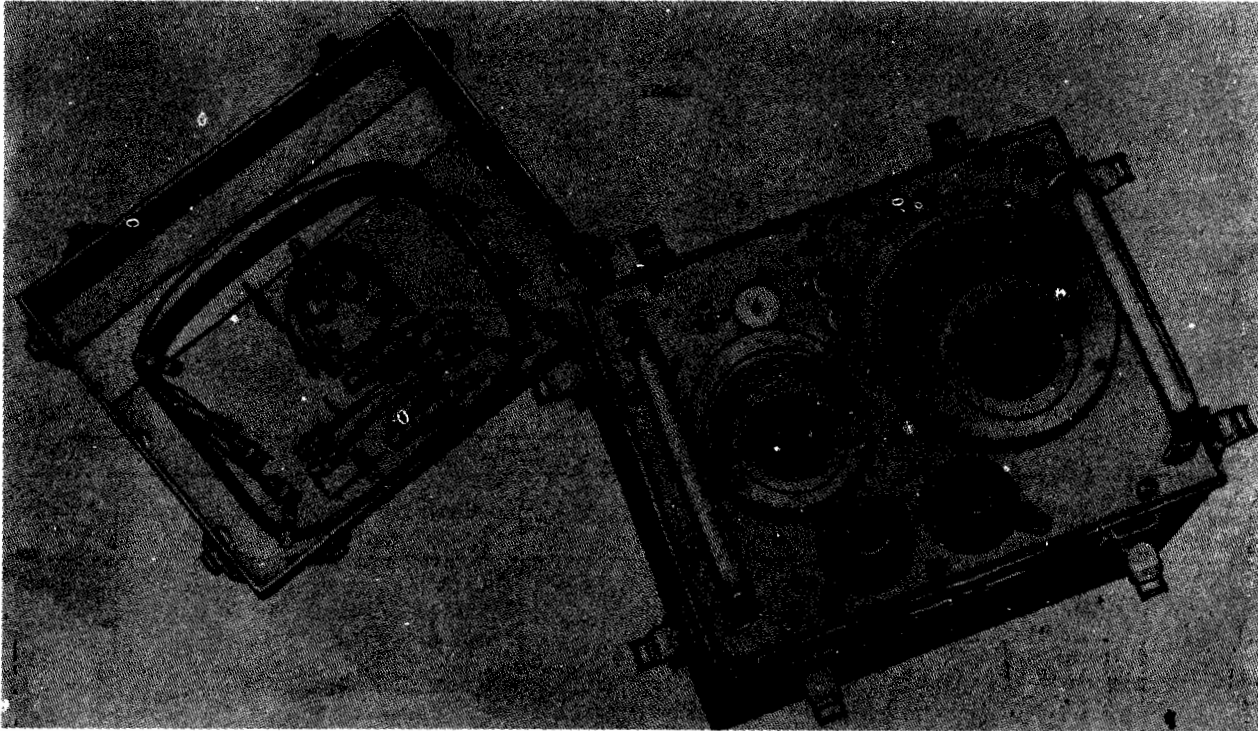
**IMPEDANCE BRIDGE****AN/URM-39***Impedance Bridge AN/URM-39***FUNCTIONAL DESCRIPTION**

The AN/URM-39 is a null instrument for use in measuring impedance at frequencies from 400 KC to 60 mc. The bridge is used with a series substitution method for measuring an unknown impedance,  $Z_x$ , in terms of its series resistance component,  $R_x$ , and series reactance component  $X_x$ . A radio frequency generator and a well shielded radio receiver comprise the accessory equipment (not supplied with AN/URM-39) necessary for satisfactory measurements. The low frequency limit is mainly determined by sensitivity considerations and in most cases satisfactory measurements can be made at frequencies as low as 100 KC.

No field changes in effect at time of preparation (7 December 1956).

**RELATION TO OTHER EQUIPMENT**

Similar to Impedance Bridge TS-582/U  
Equipment Required but not Supplied: (1)

RF Signal Generator Sets AN/URM-25 and AN/URM-26 series, 1 Radio Receiver.

**ELECTRICAL AND MECHANICAL CHARACTERISTICS**

FREQUENCY RANGE: 400 kc to 60 mc.  
RESISTANCE COMPONENT  
RANGE: 0 to 1000 ohms.  
ACCURACY:  $\pm 1\%$ ,  $\pm 0.1$  ohm.  
REACTANCE COMPONENT: 0 to 5000 ohms at 1 mc.  
ACCURACY:  $\pm 2\%$ ,  $\pm 1$  ohm.

**MANUFACTURER'S OR CONTRACTOR'S DATA**

General Radio Company, Cambridge, Mass.  
Contract NObsr 52620.  
Approximate Cost: \$1050.00 with equipment spares.

**TUBE AND/OR CRYSTAL COMPLEMENT**

No Electron Tubes.

June 1957

Test-Impedance and Standing Wave Ratio

**AN/URM-39****IMPEDANCE BRIDGE****REFERENCE DATA AND LITERATURE**

NAVSHIPS 92123: Technical Manual for Impedance Bridge AN/URM-39.

TYPE CLASSIFICATION	
DESIGN COGNIZANCE	BUSHIPS
PROCUREMENT COGNIZANCE	
STOCK NO.	
R.D.B. IDENT. NO.	

**SHIPPING DATA**

NUMBER OF BOXES	CONTENTS AND IDENTIFICATION	VOLUME (Cu.Ft.)	OVERALL DIMENSIONS (inches)	WEIGHT PACKED (lbs.)
1	Impedance Bridge AN/URM-39	5.3	19 X 21 X 23	75

**EQUIPMENT SUPPLIED DATA**

QUANTITY PER EQUIPT	NAME AND NOMENCLATURE	OVERALL DIMENSIONS (inches)	WEIGHT (lbs.)
1	Impedance Bridge Instrument AN/URM-32	11-1/4 X 12-1/4 X 14-1/8	29
2	Technical Manual NAVSHIPS 92123	1/4 X 8-1/2 X 11	

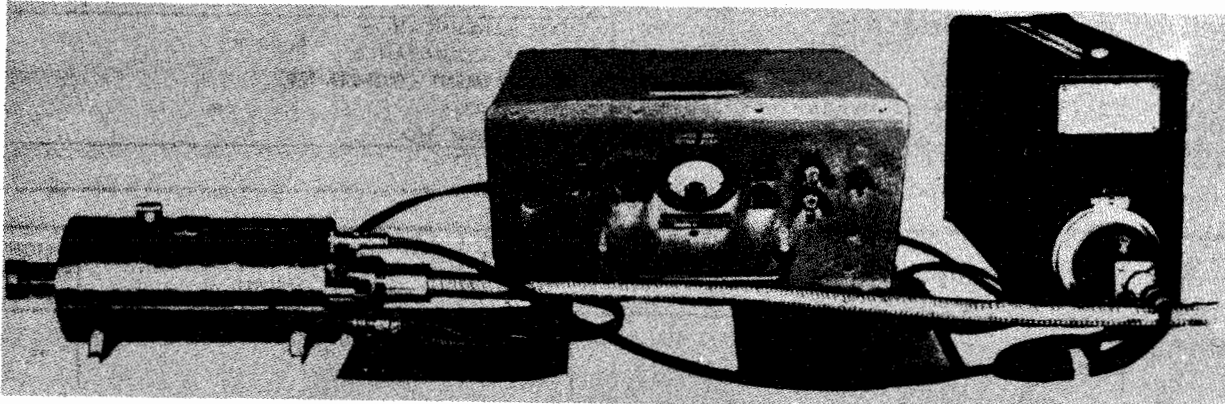
**INDICATOR, STANDING WAVE RATIO AN/URM-88(XN-1)***Indicator, Standing Wave Ratio AN/URM-88(XN-1)***FUNCTIONAL DESCRIPTION**

The AN/URM-88(XN-1) provides a means by which the voltage standing wave ratio existing on a transmission line may be measured automatically and continuously. This system is adaptable to either a 72 ohm unbalanced coaxial transmission line or to a balanced 600 ohm transmission line. This equipment is capable of the measurement of standing wave ratios at frequencies from 2 mc to 30 mc at power levels from 500 watts to 15 kilowatts.

No field changes in effect at time of preparation (16 August 1957).

**ELECTRICAL AND MECHANICAL CHARACTERISTICS**

FREQUENCY RANGE: 2 to 30 mc.

POWER CAPABILITIES: 500 to 15,000 watts

REQUIRED INPUT: RF power into either a 600 ohm balanced transmission line or 72 ohm unbalanced transmission line.

VSWR RANGE: From 1 to infinity with a center scale value of three; calibrated from unity to 10.

ACCURACY: Nominal 0.1 reflection coefficient.

POWER SOURCE REQUIRED: 115 v, 60 cps, single ph, 120 W.

AMBIENT TEMPERATURE RANGE: 35 deg to 55 deg C.

RELATIVE HUMIDITY: 0 to 90%.

**MANUFACTURER'S OR CONTRACTOR'S DATA**

General Electronics Laboratories Inc, Cambridge, Mass.

Contract NObsr-64233 dated 21 June 1954.

**TUBE AND/OR CRYSTAL COMPLEMENT**

(4) 5726	(2) 5881
(4) 5814	(1) 5R4GWY
(1) 12AY7	(2) OB2
(2) 5751	(2) 9006

Total Tubes: (18)

**REFERENCE DATA AND LITERATURE**

NAVSHIPS 92985, Technical Manual for Indicator, Standing Wave Ratio AN/URM-88(XN-1).

TYPE CLASSIFICATION
DESIGN COGNIZANCE BUSHIPS
PROCUREMENT COGNIZANCE
STOCK NO.
R.D.B. IDENT. NO.

**SHIPPING DATA**

NUMBER OF BOXES	CONTENTS AND IDENTIFICATION	VOLUME (Cu.Ft.)	OVERALL DIMENSIONS (inches)	WEIGHT PACKED (lbs.)
1	Indicator, Standing Wave Ratio AN/URM-88(XN-1) C/O			



January 1958

Test-Impedance and Standing Wave Ratio

**AN/URM-88(XN-1) INDICATOR, STANDING WAVE RATIO****SHIPPING DATA**

NUMBER OF BOXES	CONTENTS AND IDENTIFICATION	VOLUME (Cu.Ft.)	OVERALL DIMENSIONS (inches)	WEIGHT PACKED (lbs.)
	(1) Standing wave Ratio Indicator Unit 1 (1) Radio Frequency Detector Unit 2 (1) Radio Frequency Detector (optional) Unit 3 (1) Resistance Standard Unit 4			

**EQUIPMENT SUPPLIED DATA**

QUANTITY PER EQUIPT	NAME AND NOMENCLATURE	OVERALL DIMENSIONS (inches)	WEIGHT (lbs.)
1	Standing wave Ratio Indicator Unit 1 of AN/URM-88(XN-1)	9-1/2 x 16 x 17	40
1	Radio Frequency Detector, Unit 2 of AN/URM-88(XN-1)	5 x 5 x 12-3/4	17
1	Radio Frequency Detector, Unit 3 of AN/URM-88(XN-1) Optional	5 x 5 x 12-3/4	17
1	Resistance Standard, Unit 4 of AN/URM-88(XN-1)	6 x 11 x 23-1/4	30

27 June 1962

Cog Service: USAF FSN:

IMPEDANCE MEASURING TEST SET AN/USM-11

Functional Class: 6.1

USA

USN

USAF

TYPE CLASS:

MANUFACTURER'S NAME/CODE NUMBER: Press Wireless Laboratories Inc., (82774).

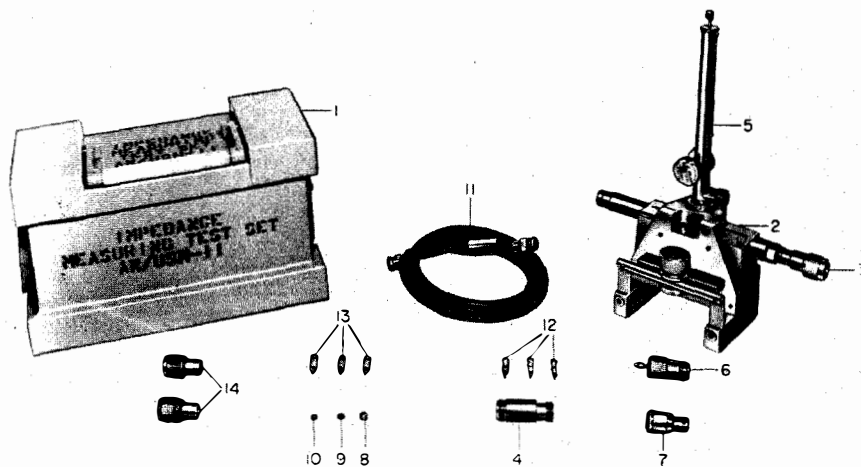

1. Case, CY-784/U
2. R.F. Transmission Line Section, CG-1252/U
3. Connector Adapter, UG-370/U
4. Connector Adapter, UG-371/U
5. R.F. Probe, MX-1019/U
6. R.F. Cable Adapter, UG-1091/U
7. Crystal Socket Adapter, UG-1092/U

8. Clear Spacer Collar
9. Green Spacer Collar
10. Red Spacer Collar
11. Cord, CG-426/U
12. Bolometer
13. Crystal
14. Adapter, UG-273/U

*Impedance Measuring Test Set AN/USM-11*

**FUNCTIONAL DESCRIPTION:**

Impedance Measuring Test Set AN/USM-11 is used in determining the voltage standing wave ratio and impedance of coaxial transmission line systems.

No field changes in effect at time of preparation (21 March 1962).

**TECHNICAL CHARACTERISTICS:**

FREQUENCY RANGE: 3,950 to 10,000 mc.

CONNECTIONS: Input type UG-23B/U, output type UG-370/U, or UG-371/U.

SLOT WIDTH: 0.125 porm 0.002 in.

PROBE TRAVEL: 7.26 cm.

RESIDUAL VSWR: Less than 1.05 with either adapter connector.

SCALE: 4.5 to 11.7 cm, with vernier.

SLOPE: Factory adjusted to less than 1% of VSWR.

---

**AN/USM-11 IMPEDANCE MEASURING TEST SET**

---

**RELATION TO OTHER EQUIPMENT:** None.

**EQUIPMENT REQUIRED BUT NOT SUPPLIED:** None.

---

**MAJOR COMPONENTS**

---

QTY	ITEM	STOCK NUMBERS	DIMENSIONS (INCHES)	WEIGHT (LBS)
1	Impedance Measuring Test Set AN/USM-11 includes:			3.18
1	Line Section, R.F. Transmission CG-1252/U includes:			
1	Adapter Connector UG-370/U			
1	Adapter Connector UG-371/U			
1	R.F. Probe MX-1019/U includes:			
1	Adapter, R.F. Cable UG-1091/U			
1	Adapter, Crystal Socket UG-1092/U			
3	Space Collars (Clear, green, red)			
2	Adapter UG-273/U			
3	Bolometer PRD-610A			
3	Crystal IN21B			
1	Cord CG-426/U		84 lg	
1	Case, Transit CY-784/U		5-1/2 x 6-1/4 x 10-3/4	

---

**REFERENCE DATA AND LITERATURE:**

---

TO 33A1-6-28-1: Handbook of Operation Instructions for Impedance Measuring Test Set AN/USM-11.

TO 33A1-6-28-2: Handbook of Service Instructions for Impedance Measuring Test Set AN/USM-11.

TO 33A1-6-28-4: Illustrated Parts Breakdown for Impedance Measuring Test Set AN/USM-11.

---

**TUBE, CRYSTAL AND/OR SEMI-CONDUCTOR DATA:**

---

TUBES: None used.

CRYSTALS: None used.

SEMI-CONDUCTORS: None used.

---

**SHIPPING DATA**

---

PKGS	VOLUME (CU FT)	WEIGHT (LBS)
------	----------------	--------------

---

4.6 AN/USM-11: 2

---

IMPEDANCE MEASURING TEST SET AN/USM-11

---

PROCUREMENT DATA

---

PROCURING SERVICE: USAF  
SPEC &/OR DWG: MIL-I-4808

DESIGN COG: USAF

---

CONTRACTOR	LOCATION	CONTRACT OR ORDER NO.	APPROX. UNIT COST
Press Wireless Laboratories Incorporated	West Newton, Massachusetts	AF33(604)-10367	

---

17 May 1962

Cog Service: USN FSN:

INDICATOR, STANDING WAVE AN/USM-114(XN-1)

Functional Class: 6.2.2

USA

USN

USAF

**TYPE CLASS:**

Used by

**MANUFACTURER'S NAME/CODE NUMBER:** Cubic Corp., (94987).

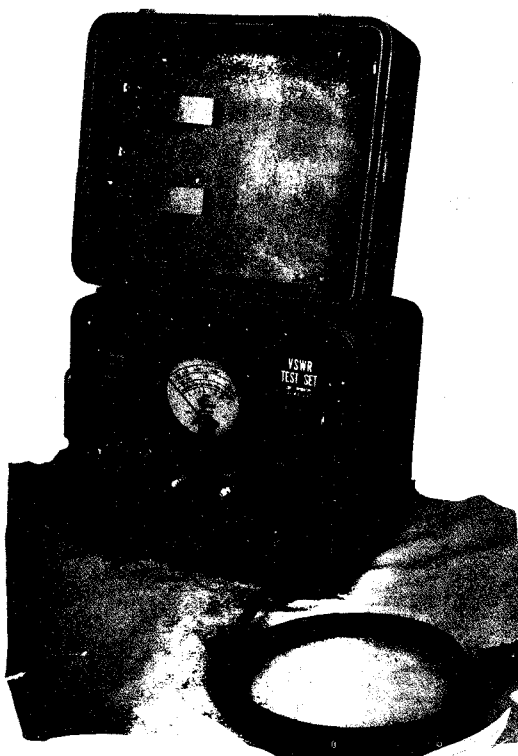

*Indicator, Standing Wave AN/USM-114(XN-1)*

**FUNCTIONAL DESCRIPTION:**

Indicator, Standing Wave AN/USM-114(XN-1) is a transistorized, general purpose test unit designed to automatically measure VSWR, under actual operating conditions, on transmission lines using bi-directional couplers. Accurate, reliable measurements on radar systems operating in the frequency range of 1,000 to 12,400 mc may thus be obtained.

No field changes in effect at time of preparation (4 April 1962).

**TECHNICAL CHARACTERISTICS:**

POWER REQUIREMENTS: 20 W, 115 v, 50 to 60 cyc, single ph.

FREQUENCY RANGE: 1,000 to 12,400 mc.

VSWR RANGE: 1.02 to 20.

**RELATION TO OTHER EQUIPMENT:** None.

---

**AN/USM-114(XN-1) INDICATOR, STANDING WAVE**

---

**EQUIPMENT REQUIRED BUT NOT SUPPLIED:** None.

---

**MAJOR COMPONENTS**

---

QTY	ITEM	STOCK NUMBERS	DIMENSIONS (INCHES)	WEIGHT (LBS)
1	Indicator, Standing Wave AN/USM-114(XN-1)		10-1/2 x 11-5/8 x 12	30

---

**REFERENCE DATA AND LITERATURE:**

NAVSHIPS 93631: Technical Manual for Indicator, Standing Wave AN/USM-114(XN-1).

---

**TUBE, CRYSTAL AND/OR SEMI-CONDUCTOR DATA:**

TUBES: None used.

CRYSTALS: None used.

SEMI-CONDUCTORS: (1) 2N297A (2) 2N338 (8) 2N384 (2) 2N417 (2) 2N1026

---

**SHIPPING DATA**

---

PKGS	VOLUME (CU FT)	WEIGHT (LBS)
------	----------------	--------------

---

---

**PROCUREMENT DATA**

---

PROCURING SERVICE: USN

DESIGN COG: USN, BuShips

SPEC &/OR DWG: SHIPS-A-2638, Amend 1

---

CONTRACTOR	LOCATION	CONTRACT OR ORDER NO.	APPROX. UNIT COST
Cubic Corp.	San Diego, California	N0bsr-72707, 23 May 1957	\$53,149.00

---

19 February 1963  
Cog Service: USAF FSN:

OHMMETER AN/USM-21A  
Functional Class: 6.1.1

USA

USN

USAF

TYPE CLASS:

Used by

MANUFACTURER'S NAME/CODE NUMBER: Bruno-New York Industries Corporation, (95325).

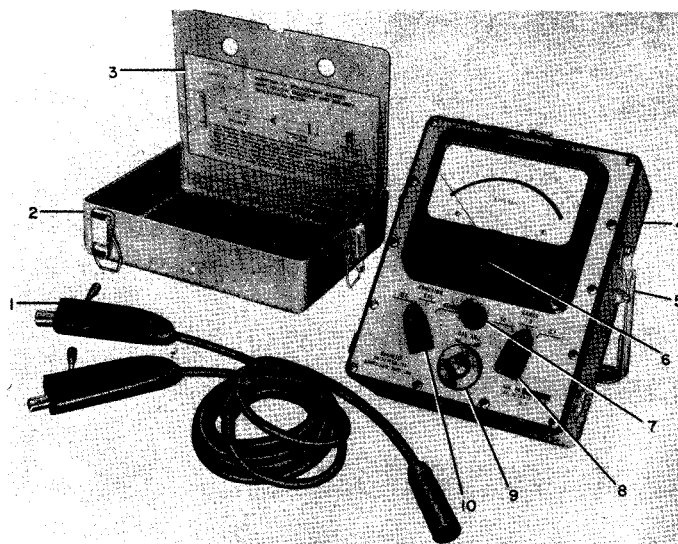

1. Test Lead CX-4469/USM-21A
2. Ohmmeter Cover
3. Battery Replacement Instruction Plate
4. Ohmmeter ZM-32/USM-21A
5. Handle
6. Zero Adjust
7. CAL. ADJ. control
8. RANGE switch
9. Telephone Plug
10. FUNCTION Switch

*Ohmmeter AN/USM-21A*

**FUNCTIONAL DESCRIPTION:**

Ohmmeter AN/USM-21A is a portable instrument designed to measure commonly encountered low resistances up to 10 ohms.

No field changes in effect at time of preparation (21 May 1962).

**TECHNICAL CHARACTERISTICS:**

POWER REQUIREMENTS: 1.34 v dc.

RESISTANCE RANGE: 0 to 0.1, 1.0, 10 ohms.

ACCURACY: Porm 1% of full scale.

RELATION TO OTHER EQUIPMENT: None.

---

**AN/USM-21A OHMMETER**

---

**EQUIPMENT REQUIRED BUT NOT SUPPLIED:**

(1) Battery BA-1328/U.

---

**MAJOR COMPONENTS**

---

QTY	ITEM	STOCK NUMBERS	DIMENSIONS (INCHES)	WEIGHT (LBS)
1	Ohmmeter AN/USM-21A includes:		4-9/16 x 7 x 8-5/16	7
1	Ohmmeter ZM-32/USM-21A			
1	Test Lead CX-4469/USM-21A			
1	Ohmmeter Cover			

---

**REFERENCE DATA AND LITERATURE:**

NAVWEPS 16-30USM21-2: Handbook of Instructions and Illustrated Parts Breakdown for AN/USM-21A.

TO 33A1-12-158-1: Handbook of Instructions and Illustrated Parts Breakdown for AN/USM-21A.

---

**TUBE, CRYSTAL AND/OR SEMI-CONDUCTOR DATA:**

TUBES: None used.

CRYSTALS: None used.

SEMI-CONDUCTORS: None used.

---

**SHIPPING DATA**

---

PKGS	VOLUME (CU FT)	WEIGHT (LBS)
------	----------------	--------------

---

**PROCUREMENT DATA**

---

PROCURING SERVICE: USAF

DESIGN COG: USAF

SPEC &/OR DWG: MIL-0-25633B

CONTRACTOR	LOCATION	CONTRACT OR ORDER NO.	APPROX. UNIT COST
Bruno-New York Industries Corporation	New York, New York	AF33(604)-14976	

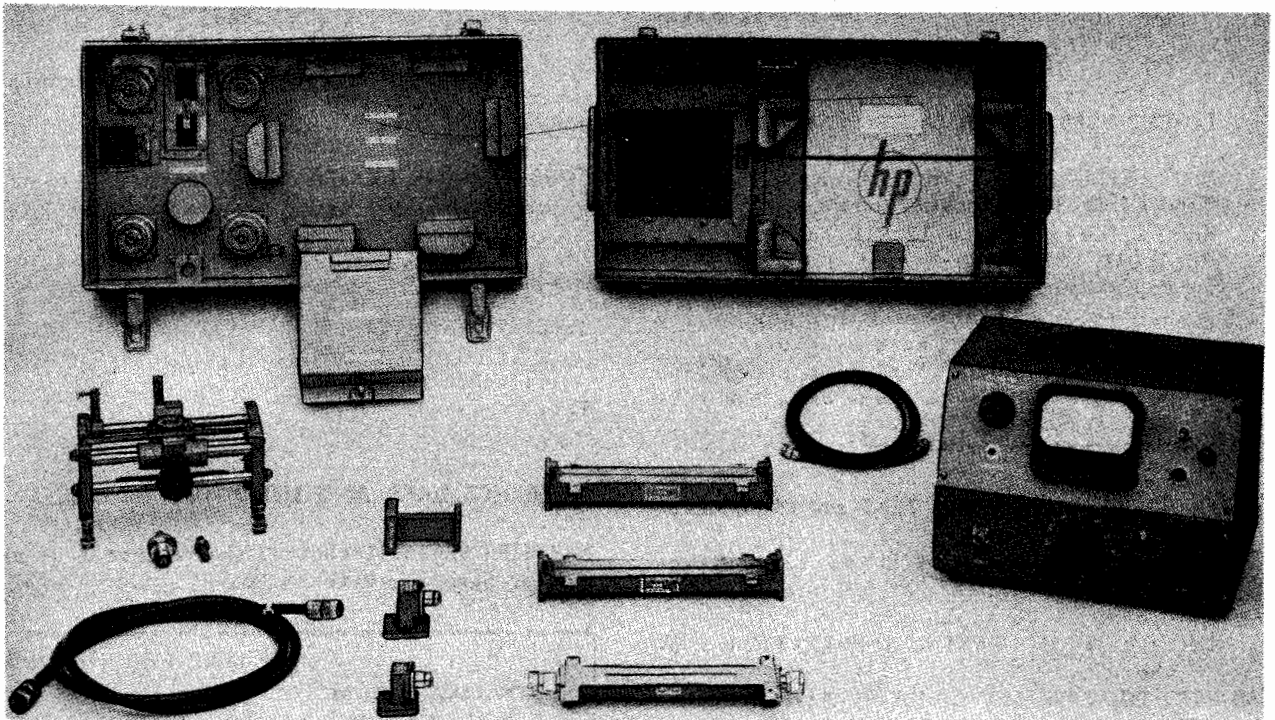

April 1958

**INDICATOR, STANDING WAVE****AN/USM-37**

Indicator, Standing Wave AN/USM-37

**FUNCTIONAL DESCRIPTION**

The AN/USM-37 is a laboratory-quality test set for use in making accurate standing-wave measurements in waveguide and coaxial systems over the frequency range from 3.0 to 12.4 Kilomegacycles. In such high frequency applications, standing-wave measurements are the customary means of investigating the impedance or impedance match of transmission systems, various types of terminations such as antennas and loads, and other high frequency devices such as connectors and transmissions. The test set includes two precision slotted waveguide sections, a voltage sampling probe, a probe carriage, a standing wave indicator, adapters and cables. The only additional equipment required is a suitable signal source and the device whose standing-wave-ratio is to be measured.

No field changes in effect at time of preparation (17 February 1958).

**ELECTRICAL AND MECHANICAL CHARACTERISTICS**

INDICATOR, STANDING WAVE IM-97/USM-37

**DETECTOR REQUIRED:** Crystal diode rectifier (supplied) or barretter (not supplied).

**MODULATION REQUIRED:** RF energy must be amplitude modulated at 1 kilocycle.

**SELECTIVITY:** Equivalent Q of unit is approximately 20; 50 cycle band width.

**SENSITIVITY:** (Input voltage for full scale reading); 0.3 uv minimum, 0.3 v max.

**NOISE:** Equivalent noise at input less than 0.04 uv.

**METER ACCURACY:**  $\pm 0.1$  db at "2",  $\pm 0.2$  db at "4" db.

**SWR "DB" RANGE SWITCH ACCURACY:**  $\pm 0.1$  db per any single step,  $\pm 0.2$  db accumulative.

**POWER SUPPLY:** 115 or 230 v, 50 to 60 cps, single ph, 65 W.

**PROBE CARRIAGE:** MX-1545/USM-37.

**PROBE TRAVEL:** 10 centimeters.

**CALIBRATION:** Can be read to 0.1 millimeter.

**ACCURACY:** Allows VSWR reading of 1.02 stop error may be adjusted to a minimum.

**WAVEGUIDE ASSEMBLIES**

**FREQ RANGE**

Test-Impedance and Standing Wave Ratio

**AN/USM-37****INDICATOR, STANDING WAVE**

April 1958

CG-1106/USM-37: 7.05 to 10 Kilomegacycles.

CG-1107/USM-37: 8.20 to 12.4 Kilomegacycles.

LOWEST VSWR (WHICH CAN BE READ): Approx 1.02.

SLOT REFLECTION (VSWR): Approx 1.01 max.

SLOTTED LINE IM-100/USM-37

FREQ RANGE: 3.0 to 12.0 Kilomegacycles.

RESIDUAL VSWR: Less than 1.04 from 3.0 to 8.0 Kilomegacycles, approx 1.06 from 8.0 to 10.0 Kilomegacycle. Approx 1.1 from 10.0 to 12.0 Kilomegacycles.

PROBE PICKUP ERROR: Variation along line 0.1 db except at extreme ends where it is 0.2 db.

ADAPTER, COAXIAL TO WAVEGUIDE

FREQ RANGE

UG-1053/USM-37: 7.05 to 10.0 Kilomegacycles.

UG-1054/USM-37: 8.20 to 12.40 Kilomegacycles.

MAX VSWR: 1.25 to 1.

IMPEDANCE OF COAXIAL TERMINATION: 50 ohms.

ADAPTER UG-152/U (WAVEGUIDE-TO-WAVEGUIDE)

FREQ RANGE: 8.20 to 10.0 Kilomegacycles.

Contract: NObsr-63074 dated 30 September, 1952.

Approximate Cost: \$955.85 with equipment spares.

**TUBE AND/OR CRYSTAL COMPLEMENT**

(1) OD3W

(1) 5Y3WGTB

(1) 6SL7WGT

Total Tubes: (7)

(1) 6SQ7GT

(1) 6V6Y

(2) 6SN7WGTA

(1) 1N26 (modified)

Total Crystals: (1)

**REFERENCE DATA AND LITERATURE**

NAVSHIPS 92036, Technical Manual for Indicator Standing Wave AN/USM-37.

TYPE CLASSIFICATION  
 DESIGN COGNIZANCE BUSHIPS  
 PROCUREMENT COGNIZANCE  
 STOCK NO.  
 R.D.B. IDENT. NO.

**MANUFACTURER'S OR CONTRACTOR'S DATA**

Hewlett-Packard Co, Palo-Alto, Calif.

**SHIPPING DATA**

NUMBER OF BOXES	CONTENTS AND IDENTIFICATION	VOLUME (Cu.Ft.)	OVERALL DIMENSIONS (inches)	WEIGHT PACKED (lbs.)
1	Indicator, Standing Wave AN/USM-37 and accessories (packed for domestic shipment and storage)	6.8	19-3/8 x 20 x 32-1/4	100
	(packed for domestic shipment and immediate use)	7.2	19-1/2 x 19-1/2 x 30-3/4	77

**EQUIPMENT SUPPLIED DATA**

QUANTITY PER EQUIPT	NAME AND NOMENCLATURE	OVERALL DIMENSIONS (inches)	WEIGHT (lbs.)
1	Indicator, Standing Wave IM-97/USM-37	9 x 9 x 12	30
1	Probe, Waveguide MX-1546/USM-37	1-1/4 x 2	0.250
1	Spare Crystal and Holder	11/16 x 2	0.063

UNCLASSIFIED

Test-Impedance and Standing Wave Ratio

April 1958

## INDICATOR, STANDING WAVE

AN/USM-37

## EQUIPMENT SUPPLIED DATA

QUANTITY PER EQUIPT	NAME AND NOMENCLATURE	OVERALL DIMENSIONS (inches)	WEIGHT (lbs.)
1	Carriage, Probe MX-1545/USM-37	6 x 7-1/2 x 8	3.438
1	Waveguide Assembly CG-1106/USM-37	1-7/8 x 2-1/2 x 10-1/4	1.375
1	Waveguide Assembly CG-1107/USM-37	1-5/8 x 2-1/2 x 10-1/4	1.125
1	Slotted Line IM-100/USM-37	1-3/16 x 2-1/2 x 9-3/4	1.375
1	Adapter UG-152/U	1-7/8 x 1-7/8 x 3-3/8	0.750
1	Adapter, Coaxial to Waveguide UG-1054/U	1-3/4 x 1-7/8 x 2-3/8	0.563
1	Adapter, Coaxial to Waveguide UG-1053/U	1-9/16 x 1-5/8 x 2-1/8	0.375
1	Cord CG-92D/U	72 lg	1
1	Cord CG-409/U	120 lg	1.666
1	Case, Indicator CY-1463/USM-37	12 x 12 x 22	15.500
2	Technical Manuals NAVSHIPS 92036		

UNCLASSIFIED

4.6 AN/USM-37: 3

31 May 1962

Cog Service: USM FSN: 6625-814-8357

INDICATOR, STANDING WAVE RATIO AN/USM-37A

Functional Class: 6.2.1

USA

USN

USAF

TYPE CLASS:

Used By

MANUFACTURER'S NAME/CODE NUMBER: Hewlett-Packard Co.

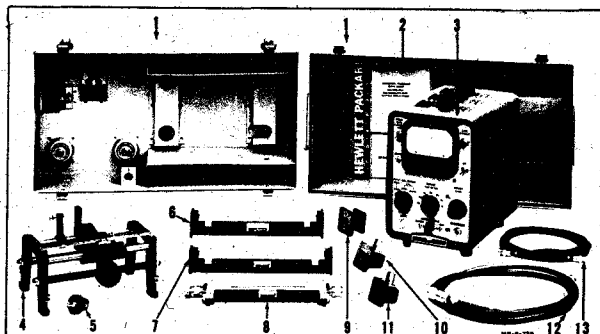

Ref	Qty. Per Equip.	Name of Unit	Military Designation	Commercial Designation	Dimensions (in.)		
					Height	Width	Depth
3	1	Indicator Standing Wave Ratio	IM-157/USM-37	415B Standing Wave Indicator	9	12	9
5	1	Probe, Waveguide	MX-1546/USM-37	444A Untuned Probe	2	1-1/4	
4	1	Carriage, Probe	MX-1545/USM-37	909B Universal Probe Carriage	7-1/2	8	6
6	1	Waveguide Assembly	CG-1106/USM-37	B110B Waveguide Slotted Section	1-7/8	2-1/2	10-1/4
7	1	Waveguide Assembly	CG-1107/USM-37	X110B Waveguide Slotted Section	1-5/8	2-1/2	10-1/4
8	1	Slotted Line	IM-100/USM-37	806B Coaxial Slotted Section	1-3/16	2-1/2	9-3/4
9	1	Adapter	UG-1398/U	HX292B Waveguide Adapter	1-7/8	1-7/8	3-3/8
11	1	Adapter, Coaxial to Waveguide	UG-1063/U	X281A Waveguide to Coaxial Adapter	2-3/8	1-7/8	1-3/4
10	1	Adapter, Coaxial	UG-1054/U	B281A Waveguide to Coaxial Adapter	2-1/8	1-5/8	1-9/16
12	1	Cord	CG-92D/U (8'0")	AC-18Q Cable Assembly			
13	1	Cord	CG-409/U (10'0")	AC-16K (10') Cable Assembly			
1	1	Case, Indicator	CY-2964/USM-37A	415B-45A(N) Transit Case	12	22	12
2	2	Instruction Books			11.5	9	0.50

Indicator, Standing Wave Ratio AN/USM-37A

**FUNCTIONAL DESCRIPTION:**

Indicator, Standing Wave Ratio AN/USM-37A is a complete laboratory-quality test set for making accurate standing-wave measurements in waveguide and coaxial transmission systems. No field changes in effect at time of preparation (15 December 1961).

**TECHNICAL CHARACTERISTICS:**

INDICATOR STANDING WAVE RATIO IM-157/USM-37

FREQUENCY: 1,000 cps perm 2%.

SENSITIVITY: 0.1 uv at a 200 ohm level for full scale deflection.

NOISE LEVEL: Less than 0.03 uv ref.

AMPLIFIER Q: 25 perm 5.

PROBE CARRIAGE MX-1545/USM-37

PROBE TRAVEL: 10 centimeters.

CALIBRATION: Can be read to 0.1 mm.

ACCURACY: Allows SWR reading of 10.2; slope error of slotted sections may be eliminated

---

**AN/USM-37A INDICATOR, STANDING WAVE RATIO**

---

by adjustment.

WAVEGUIDE ASSY CG-1106/USM-37

FREQUENCY: 7.05 to 10.0 kmc.

WAVEGUIDE ASSY CG-1107/USM-37

FREQUENCY: 8.20 to 12.40 kmc.

SLOTTED LINE IM-100/USM-37

FREQUENCY RANGE: 3,000 to 12,000 mc.

IMPEDANCE: 50 ohms.

POWER REQUIREMENTS: 55 W, 115 or 230 v, 60 cyc, single ph.

**RELATION TO OTHER EQUIPMENT:** None.

**EQUIPMENT REQUIRED BUT NOT SUPPLIED:** None.

---

**MAJOR COMPONENTS**

---

QTY	ITEM	STOCK NUMBERS	DIMENSIONS (INCHES)	WEIGHT (LBS)
1	Indicator, Standing Wave Ratio AN/USM-37A includes:			
1	Indicator, Standing Wave Ratio IM-157/USM-37		9 x 9 x 12	
1	Probe, Waveguide MX-1546/USM-37		1-1/4 dia x 2	
1	Carriage, Probe MX-1545/USM-37		6 x 7-1/2 x 8	
1	Waveguide Assy CG-1106/USM-37		1-7/8 x 2-1/2 x 10-1/4	
1	Waveguide Assy CG-1107/USM-37		1-5/8 x 2-1/2 x 10-1/4	
1	Slotted Line IM-100/USM-37		1-3/16 x 2-1/2 x 9-3/4	
1	Adapter, Waveguide UG-1398/U		1-7/8 x 1-7/8 x 3-3/8	
1	Adapter, Coaxial to Waveguide UG-1053/U		1-3/4 x 1-7/8 x 2-3/8	
1	Adapter, Coaxial to Waveguide UG-1054/U		1-9/16 x 1-5/8 x 2-1/8	
1	Cord CG-92D/U		72 lg	
1	Cord CG-409/U		120 lg	
1	Case, Indicator CY-2964/USM-37A		12 x 12 x 22	
2	Technical Manual NAVSHIPS 93809		0.50 x 9 x 11.5	

---

**REFERENCE DATA AND LITERATURE:**

NAVSHIPS 93809: Technical Manual for Indicator, Standing Wave Ratio AN/USM-37A.

---

**TUBE, CRYSTAL AND/OR SEMI-CONDUCTOR DATA:**

TUBES: (1) 082 (1) 6AU5 (1) 6AX5 (1) 6CB6 (1) 6DJ8 (2) 12AX7

CRYSTALS: None used.

SEMI-CONDUCTORS: (1) 1N76 (1) HD-2135

---

**SHIPPING DATA**

---

PKGS	VOLUME (CU FT)	WEIGHT (LBS)
1		

4.6 AN/USM-37A: 2

---

INDICATOR, STANDING WAVE RATIO AN/USM-37A

---

PROCUREMENT DATA

---

PROCURING SERVICE: USN  
SPEC &/OR DWG:

DESIGN COG: USN, BuShips

---

CONTRACTOR	LOCATION	CONTRACT OR ORDER NO.	APPROX. UNIT COST
Hewlett-Packard Co.	Palo Alto, California	NObsr-81209	\$905.28
		NObsr-81557	
		NObsr-85369	\$1,027.12

---

8 February 1963

MEGOHMMETER CAG-1862-B

Cog Service:

FSN:

Functional Class: 6.1.1

USA

USN

USAF

**TYPE CLASS:**

**MANUFACTURER'S NAME/CODE NUMBER:** General Radio Company, (24655).

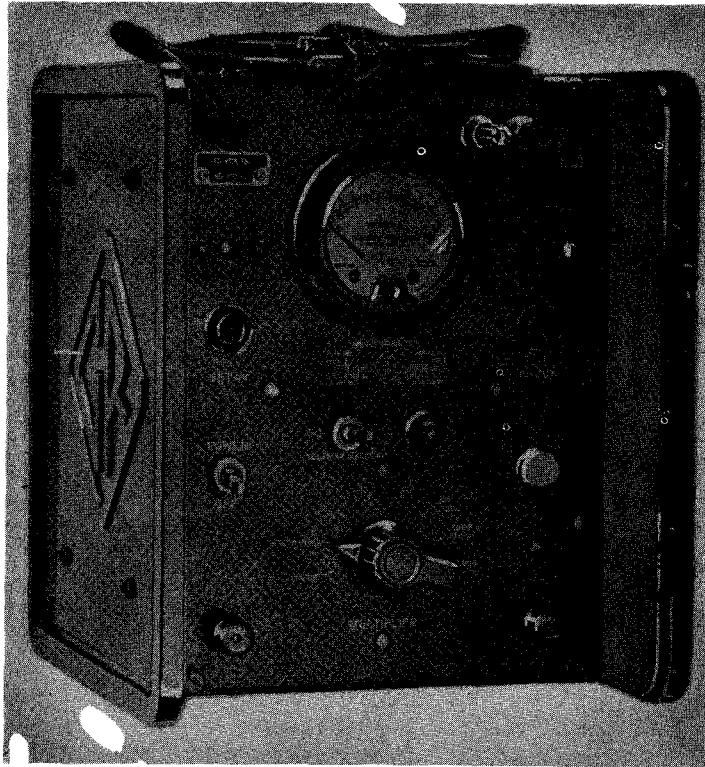

*Megohmmeter CAG-1862-B*

**FUNCTIONAL DESCRIPTION:**

Megohmmeter CAG-1862-B is designed for insulation and leakage resistance measurement. It consists of a stabilized power supply, a complement of resistance standards and an indicating meter. The meter is a balanced direct current vacuum-tube voltmeter.

No field changes in effect at time of preparation (6 February 1963).

**TECHNICAL CHARACTERISTICS:**

TEST VOLTAGES: 50 v and 500 v.

ACCURACY: Porm 3% to porm 12% on 500 v; porm 5% to porm 17% on 50 v.

POWER REQUIREMENTS: 115 or 230 v, 40 to 60 cps, single ph.

**RELATION TO OTHER EQUIPMENT:** None.

---

**CAG-1862-B MEGOHMMETER**

---

**EQUIPMENT REQUIRED BUT NOT SUPPLIED:** None.

---

**MAJOR COMPONENTS**

---

QTY	ITEM	STOCK NUMBERS	DIMENSIONS (INCHES)	WEIGHT (LBS)
1	Megohmmeter CAG-1862-B		9-1/8 x 10-1/8 x 11-3/4	15-1/2

---

---

**REFERENCE DATA AND LITERATURE:**

Operating Instructions for Type no. 1862-B Megohmmeter.

---

---

**TUBE, CRYSTAL AND/OR SEMI-CONDUCTOR DATA:**

TUBES: (1) 12AU7 (1) 0A2 (1) 6X4 (1) 2X2-A (1) 6AB4 (1) 6AU6 (1) 5651

CRYSTALS: None used.

SEMI-CONDUCTORS: None used.

---

---

**SHIPPING DATA**

---

PKGS	VOLUME (CU FT)	WEIGHT (LBS)
------	----------------	--------------

---

---

**PROCUREMENT DATA**

---

PROCURING SERVICE:  
SPEC &/OR DWG:

DESIGN CCG: Commercial

---

CONTRACTOR	LOCATION	CONTRACT OR ORDER NO.	APPROX. UNIT COST
General Radio Company Type no. 1862-B	Cambridge, Mass.		\$155.00

---



UNCLASSIFIED

April 1958

Test-Impedance and Standing Wave Ratio

### TEST SET

### I-48-B

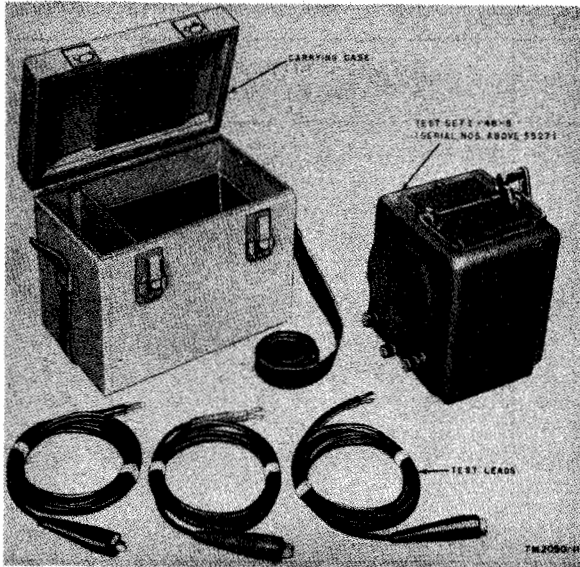

Test Set I-48-B Serial Numbers 5527 and Higher

#### FUNCTIONAL DESCRIPTION

The I-48-B is a portable, self-contained, constant-voltage insulation resistance measuring set used to determine the condition of the insulation of all type of electrical equipment of which insulation resistance is an important factor. It is designed to be used on equipment having a voltage rating over 500 volts, as the potential supplied may be destructive to equipment with a voltage rating under 500 volts.

No field changes in effect at time of preparation (21 April 1958).

#### RELATION TO OTHER EQUIPMENT

The I-48-B is identical to J.G. Biddle Company Number 7679 and is similar to I-48-A

differing in that the 1 to 10 resistance ratio switch in the I-48-B has been omitted. The I-48-B is also similar to Ohmmeter ZM-21A/U.

#### ELECTRICAL AND MECHANICAL CHARACTERISTICS

RANGE: 0 to 1000 meg.  
 TEST POTENTIAL: 500 v DC  $\pm 5\%$ .  
 ACCURACY:  $\pm 1\%$ .  
 POWER SOURCE: Built-in hand generator, 500 v constant pressure type.

#### MANUFACTURER'S OR CONTRACTOR'S DATA

Interstate Mfg Company, Newark, N.J.  
 Order 29191-Phila-43-52.  
 Order 31080-Phila-43.  
 Order 34909-Phila-43.  
 Order 8724-Phila-44.  
 Order 28629-Phila-44.  
 Approximate Cost: \$150.00 with equipment spares.

#### TUBE AND/OR CRYSTAL COMPLEMENT

No Electron Tubes or Crystals used.

#### REFERENCE DATA AND LITERATURE

TM11-2050: Technical Manual for Test Set I-48-B and Ohmmeter ZM-21A/U.

TYPE CLASSIFICATION
DESIGN COGNIZANCE TASSA
PROCUREMENT COGNIZANCE 71-3256
STOCK NO.
R.D.B. IDENT. NO.

#### SHIPPING DATA

NUMBER OF BOXES	CONTENTS AND IDENTIFICATION	VOLUME (Cu.Ft.)	OVERALL DIMENSIONS (inches)	WEIGHT PACKED (lbs.)
1	Domestic Shipment	0.7	9 x 11 x 12-1/4	16
	Test Set I-48-B(Ser 1 thru 5526) or Test Set I-48-B(Ser 5527 and higher)	1.2	11-1/4 x 13 x 13-3/4	21
1	Export Shipment	1.1	10-7/8 x 12-7/8 x 14-1/8	23
	Test Set I-48-B(Ser 1 thru 5526 or Test Set I-48-B(Ser 5527 and higher)	1.6	12 x 13-1/2 x 17	32

UNCLASSIFIED

**I-48-B****TEST SET****EQUIPMENT SUPPLIED DATA**

QUANTITY PER EQUIPT	NAME AND NOMENCLATURE	OVERALL DIMENSIONS (inches)	WEIGHT (lbs.)
	I-48-B (Ser. No. 1 thru 5526)		
1	Test Set I-48-B	6 x 7-1/4 x 7-1/2	10.7
1	Carrying Case	6-1/2 x 8-1/2 x 9-3/4	4.0
2	Test Lead	120 lg	0.6
2	Technical Manual TM11-2050	3/16 x 6 x 9-1/4	
	I-48-B (Ser. No. 5527 and higher)		
1	Test Set I-48-B	6 x 7-1/4 x 7-1/2	10.7
1	Carrying Case	7-1/8 x 8-7/8 x 10-5/8	5.3
3	Test Lead	120 lg	0.8
2	Technical Manual TM11-2050	3/16 x 6 x 9-1/4	

UNCLASSIFIED

April 1958

Test-Impedance and Standing Wave Ratio  
**STANDING WAVE INDICATOR** **IM-58/U**

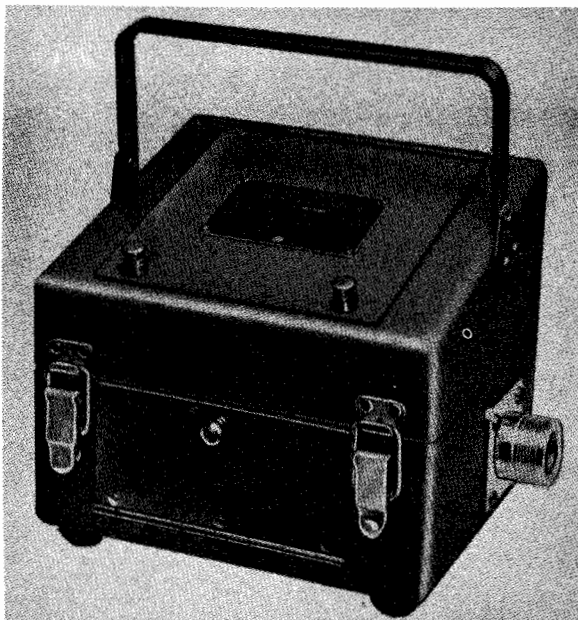

*Standing Wave Indicator IM-58/U*

placed at the point of adjustment for convenience in use.

No field changes in effect at time of preparation (14 November 1957).

**ELECTRICAL AND MECHANICAL CHARACTERISTICS**

FREQUENCY RANGE: 200 kc to 30 mc.

STANDING WAVE RATIO DATA

RANGE: 1 to 100.

ACCURACY

RATIOS 1 to 3: ±20%.

RATIOS 3 to 10: ±10%.

POWER INDICATION DATA

RANGE: 5 to 500 W.

ACCURACY: ±5% full scale RF power.

INPUT IMPEDANCE: 50 to 75 ohms.

**MANUFACTURER'S OR CONTRACTOR'S DATA**

Radio Corp of America, RCA Victor Division,  
 Camden, N. J.

Contract NObsr-49060, dated 17 February  
 1950.

Approximate Cost: \$590.00 with equip-  
 ment spares.

**FUNCTIONAL DESCRIPTION**

The IM-58/U is a portable unit designed to indicate directly the standing wave ratio in a coaxial transmission line connecting an RF power source with its load. It is intended to facilitate the tuning of antenna matching elements in radio transmitter installations, and contains a switching system which permits it, after calibration at one point on its scale against a known load, to indicate directly the RF power flowing in the coaxial transmission line.

It is contained in two metal cases fastened together for ease in handling. The two sections are electrically connected by a cable, permitting the coupling section to be installed at a convenient place in the transmission line while the meter section is

**TUBE AND/OR CRYSTAL COMPLEMENT**

No Electron Tubes.

(1) 1N69

Total Crystals: (1)

**REFERENCE DATA AND LITERATURE**

NAVSHIPS 91386: Technical Manual for Stand-  
 ing Wave Indicator IM-58/U.

<b>TYPE CLASSIFICATION</b>
<b>DESIGN COGNIZANCE</b> BUSHIPS
<b>PROCUREMENT COGNIZANCE</b>
<b>STOCK NO.</b>
<b>R.D.B. IDENT. NO.</b> 6.2.2

**SHIPPING DATA**

NUMBER OF BOXES	CONTENTS AND IDENTIFICATION	VOLUME (Cu.Ft.)	OVERALL DIMENSIONS (inches)	WEIGHT PACKED (lbs.)
1	Standing Wave Indicator IM-58/U	4.9	17 x 22-1/4 x 22-1/2	30

**EQUIPMENT SUPPLIED DATA**

QUANTITY PER EQUIPT	NAME AND NOMENCLATURE	OVERALL DIMENSIONS (inches)	WEIGHT (lbs.)
1	Standing Wave Indicator IM-58/U	6-3/4 x 7-1/4 x 9-3/8	7.5
2	Technical Manual NAVSHIPS 91386	3/8 x 9 x 11-1/2	

UNCLASSIFIED

4.6 IM-58/U: 1

April 1958

Test-Impedance and Standing Wave Ratio

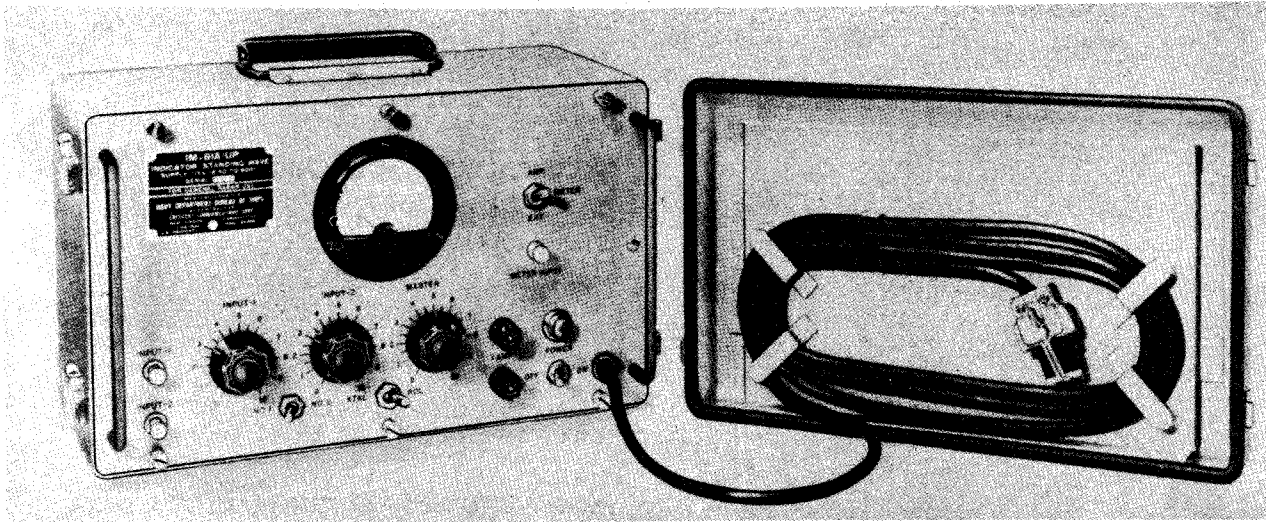
**STANDING WAVE INDICATOR IM-81/UP, IM-81A/UP**

*Standing Wave Indicator IM-81/UP, IM-81A/UP*

**FUNCTIONAL DESCRIPTION**

The IM-81/UP and IM-81A/UP are employed when it is desired to measure the standing wave ratio within a waveguide system used with a source of pulsed r-f power. Input to the IM-81/UP and IM-81A/UP may be from either a square law crystal or bolometer. The crystal current for a square law crystal is proportional to the square of the applied voltage. The signal is applied to the Standing Wave Indicator which amplifies and rectifies the signal and applies it to a meter. The meter is calibrated directly to read Voltage Standing Wave Ratio.

No field changes in effect at time of preparation (28 February 1958).

**ELECTRICAL AND MECHANICAL CHARACTERISTICS****INPUTS**

INPUT 1: RF probe w/crystal rectifier or bolometer.

INPUT 2: Probe w/crystal rectifier or bolometer.

INPUT IMPEDANCE: 250 ohms.

**RESPONSE**

FREQUENCY: (500-2000 cps) linear within 3 db.

AMPLIFICATION: Linear within 5% from 15% of full scale to full scale reading.

SENSITIVITY: 15 uv full scale meter reading for frequency range of 500 to 2000 cps; 20 uv full scale at 400 and 4000 cps.

STANDING WAVE INDICATION: 1:1 to 4:1, in addition a linear scale on the meter reading from 0 to 10.

POWER SOURCE REQUIRED: 115v, 50 to 800 cps, single ph, 35 W.

**MANUFACTURER'S OR CONTRACTOR'S DATA**

Tred Television Corp, Asbury Park, N.J.  
Contract: NObsr-52707, dated 22 June 1951 (IM-81/UP).

Crescent Communications Corp, New London, Conn.

Contract: NObsr-64266, dated 30 June 1954 (IM-81A/UP).

**TUBE AND/OR CRYSTAL COMPLEMENT**

	IM-81/UP	
(2) 6SJ7		(1) 6V6
(1) 6H6		(1) 6X5GT
Total Tubes: (5)		
	IM-81A/UP	
(1) 6SJ7		(1) 6AU6WA
(1) 6005/6AQ5W		(1) 5726/6AL5W
(1) 6X4WA		
Total Tubes: (5)		

Test-Impedance and Standing Wave Ratio

**IM-81/UP, IM-81A/UP STANDING WAVE INDICATOR**

April 1958

No Crystals used.

**REFERENCE DATA AND LITERATURE**

NAVSHIPS 91722: Technical Manual for Standing Wave Indicator IM-81/UP.

NAVSHIPS 92469: Technical Manual for Standing Wave Indicator IM-81A/UP.

TYPE CLASSIFICATION
DESIGN COGNIZANCE
PROCUREMENT COGNIZANCE
STOCK NO.
R.D.B. IDENT. NO.

**SHIPPING DATA**

NUMBER OF BOXES	CONTENTS AND IDENTIFICATION	VOLUME (Cu.Ft.)	OVERALL DIMENSIONS (inches)	WEIGHT PACKED (lbs.)
1	Standing Wave Indicator IM-81/UP	1.72	12 X 12-3/4 X 20	48
1	Standing Wave Indicator IM-81A/UP	1.8	12 X 13-1/2 X 19	38

**EQUIPMENT SUPPLIED DATA**

QUANTITY PER EQUIPT	NAME AND NOMENCLATURE	OVERALL DIMENSIONS (inches)	WEIGHT (lbs.)
1	Standing wave Indicator IM-81/UP	8-11/16 X 8-7/8 X 16-9/16	36
1	Standing wave Indicator IM-81A/UP	8-7/8 X 9-9/16 X 15-1/8	23

April 1958

**STANDING WAVE INDICATOR****IM-89/UR**

Test-Impedance and/or Standing Wave Ratio

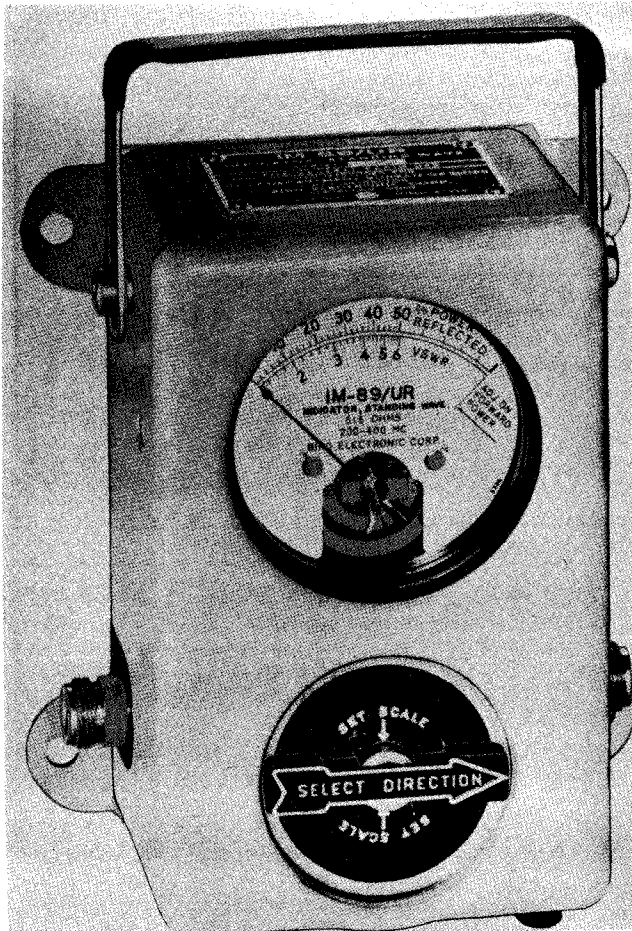

Standing Wave Indicator IM-89/UR

**FUNCTIONAL DESCRIPTION**

The IM-89/UR is a self-contained test equipment designed for insertion in the transmission line between the transmitter and a termination, such as an antenna or dummy load, to measure voltage standing wave ratio or percent power reflected for any source and load within its rating. The measurements with this instrument will give an indication of the condition of the antenna, transmission line and connectors. It will also monitor forward or reflected power in the transmission line. The forward or reflected power may be selected by means of a directional switch rotates a coupling structure with reference to the primary line. The transmitter or load may be connected to either side

of the instrument. It may be used as a monitor in a fixed position or for trouble shooting in portable application.

No field changes in effect at time of preparation (11 March 1958).

**ELECTRICAL AND MECHANICAL CHARACTERISTICS****SCALE CALIBRATIONS**

REFLECTED POWER: 0 to 50%.

VSWR: 1:1 to 6:1 ratio.

FREQUENCY RANGE: 200 to 400 mc.

LINE IMPEDANCE: 51.5 ohms nominal.

POWER RANGE: 10 to 40 W forward.

**ACCURACY (FULL SCALE)**20 TO 50% OF REFLECTED POWER:  $\pm 3\%$ .0 TO 20% OF REFLECTED POWER:  $\pm 2\%$ .

DIRECTIVITY: 30 db minimum.

TYPE OF MODULATION: CW, AM, FM or Television type signals (Not designed for use on pulse power similar to radar).

**MANUFACTURER'S OR CONTRACTOR'S DATA**

Bird Electronic Corp, Cleveland, Ohio.  
Contract NObsr-57238 dated 18 Feb 1952.

**TUBE AND/OR CRYSTAL COMPLEMENT**

No Tubes used.

(1) CK-710

Total Crystals: (1)

**REFERENCE DATA AND LITERATURE**

NAVSHIPS 92088, Technical Manual for Standing Wave Indicator IM-89/UR.

TYPE CLASSIFICATION  
DESIGN COGNIZANCE BUSHIPS  
PROCUREMENT COGNIZANCE  
STOCK NO.  
R.D.B. IDENT. NO.

Test-Impedance and/or Standing Wave Ratio

IM-89/UR

## STANDING WAVE INDICATOR

April 1958

## SHIPPING DATA

NUMBER OF BOXES	CONTENTS AND IDENTIFICATION	VOLUME (Cu.Ft.)	OVERALL DIMENSIONS (inches)	WEIGHT PACKED (lbs.)
1	Indicator, Standing Wave IM-89/UR incl (2) Technical Manuals NAVSHIPS 92088	0.48	6-5/8 X 10-3/16 X 12-5/16	8

## EQUIPMENT SUPPLIED DATA

QUANTITY PER EQUIPT	NAME AND NOMENCLATURE	OVERALL DIMENSIONS (inches)	WEIGHT (lbs.)
1	Indicator, Standing Wave IM-89/UR	3-1/8 X 5-1/8 X 6-3/4	3.6
2	Technical Manual NAVSHIPS 92088		

UNCLASSIFIED

April 1958

Test-Impedance and Standing Wave Ratio

## STANDING WAVE MEASURING EQUIPMENT

OAK

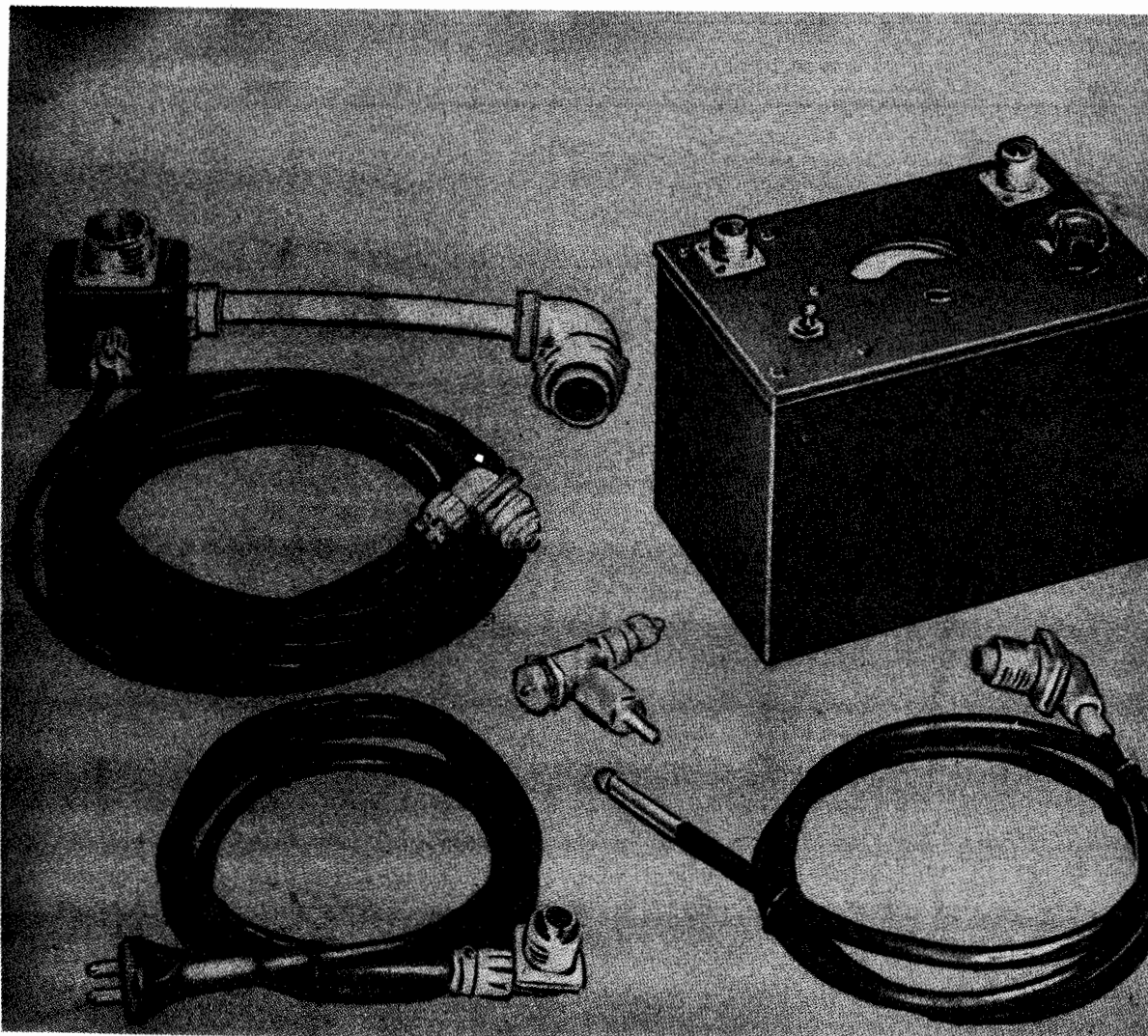

*Standing Wave Measuring Equipment OAK*

### FUNCTIONAL DESCRIPTION

The OAK is a slotted line test set for measuring and when used in conjunction with impedance matching equipments, for adjusting the standing wave ratio of RF transmission lines and antennas of aircraft radar equipments.

No field changes in effect at time of preparation (10 April 1958).

PULSE WIDTH: 1 usec.

POWER SOURCE REQUIRED: 115 v, 60/1000 cps,  
1 ph.

### MANUFACTURER'S OR CONTRACTOR'S DATA

Philco Corp, Philadelphia, Pa.  
Contract NXsa/s-32853.

### ELECTRICAL AND MECHANICAL CHARACTERISTICS

APPROX OPERATING FREQUENCY: 3300 mc.  
PULSE RATE: 600 cps.

### TUBE AND/OR CRYSTAL COMPLEMENT

(1) 6H6GT

(1) 6SJ7WGT

UNCLASSIFIED

4.6 OAK: 1



April 1958

Test-Impedance and Standing Wave Ratio

**OAK****STANDING WAVE MEASURING  
EQUIPMENT**(1) 6SL7WGT  
Total Tubes: (4)  
No Crystals used.

(1) 6X5WGT

TYPE CLASSIFICATION
DESIGN COGNIZANCE BUSHIPS
PROCUREMENT COGNIZANCE
STOCK NO.
R.D.B. IDENT. NO.

**REFERENCE DATA AND LITERATURE**NAVSHIPS 95160: Technical Manual for Navy  
Models OAJ, OAJ-1, and OAK Test Equipments.**EQUIPMENT SUPPLIED DATA**

QUANTITY PER EQUIPT	NAME AND NOMENCLATURE	OVERALL DIMENSIONS (inches)	WEIGHT (lbs.)
1	Rectifier-Amplifier-50ABY	5 X 5-25/32 X 8	8.88
1	Junction Box-62074 (w/cables)	2 X 2-13/16 X 3	2.13
1	Slotted Transmission Line-62ABD	11 lg	0.9
1	Antenna Switching-14AAD	31/32 X 3 X 3.5	1.0
1	Flexible RF Cable	36 lg	1.75
1	60 cps Power Cable	10 lg	0.56
1	Carrying Case	11 X 12 X 13	12.75

**RADIO FREQUENCY IMPEDANCE MEASURING EQUIPMENT**

**OCK**

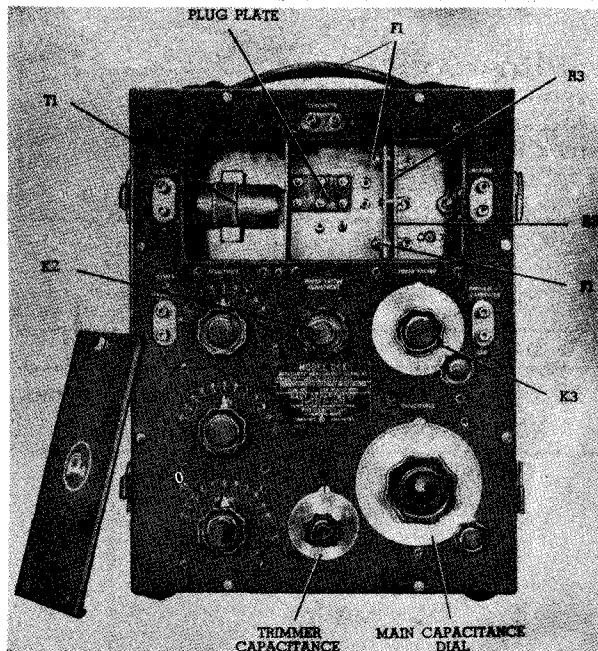

*RF Impedance Measuring Equipment OCK*

- Direct (Schering Bridge).
  - Series-Capacitor (Equal-Arm Capacitance Bridge).
  - Parallel-Capacitor (Equal-Arm Capacitance Bridge).
  - Parallel-Capacitor (Schering Bridge).
- OPERATING RANGES**
- FREQUENCY: 25 to 5000 kc.
  - RESISTANCE: 0.1 to 311 ohms.
  - REACTANCE (at 1000 kc).
  - CAPACITIVE: 0.016 to 152800 ohms.
  - INDUCTIVE: 0.016 to 58000 ohms.

- ACCURACY**
- 25 TO 1500 KC
  - RESISTANCE:
    - ±2% 0.1 to 111 ohms.
    - ±2.5% 111 to 211 ohms.
    - ±3% 211 to 311 ohms.
  - REACTANCE: ±1% or ±5 uuf whichever is greater.
  - 1500 TO 5000 KC
  - MULTIPLY ABOVE ACCURACY LIMITS BY:
    - 1.2 at 2000 kc.
    - 1.5 at 3000 kc.
    - 2.0 at 4000 kc.
    - 2.5 at 5000 kc.

**MANUFACTURER'S OR CONTRACTOR'S DATA**

Photoswitch Inc., Cambridge, Mass.  
 Contract NXsr-66790.  
 Approximate Cost: \$250.00 with equipment spares.

**TUBE AND/OR CRYSTAL COMPLEMENT**

No Electron Tubes or Crystals used.

**REFERENCE DATA AND LITERATURE**

NAVSHIPS 95169: Technical Manual for Impedance Measuring Equipment Navy Model OCK.

<b>TYPE CLASSIFICATION</b>
<b>DESIGN COGNIZANCE</b> BUSHIPS
<b>PROCUREMENT COGNIZANCE</b>
<b>STOCK NO.</b>
<b>R.D.B. IDENT. NO.</b>

**FUNCTIONAL DESCRIPTION**

The OCK is a bridge for the measurement of impedances at radio frequencies. It is adaptable to the measurement of any physical form of impedance but the technique employed depends to some extent upon the nature of the impedance. A specific application is the measurement of the reactance and effective resistance of radio antennas, transmission lines and radio trunk lines.

No field changes in effect at time of preparation (14 April 1958).

**RELATION TO OTHER EQUIPMENT**

Equipment Required but not Supplied: Standard Signal Generator as source of RF power.

**ELECTRICAL AND MECHANICAL CHARACTERISTICS**

**METHOD OF MEASUREMENT:**  
 Direct (Equal-Arm Capacitance Bridge).

**EQUIPMENT SUPPLIED DATA**

QUANTITY PER EQUIPT	NAME AND NOMENCLATURE	OVERALL DIMENSIONS (inches)	WEIGHT (lbs.)
1	RF Impedance Bridge NT-60117		26
1	Accessory Box		18

UNCLASSIFIED

March 1957

# Test-Impedance and Standing Wave Ratio INSULATION RESISTANCE TESTER OCW

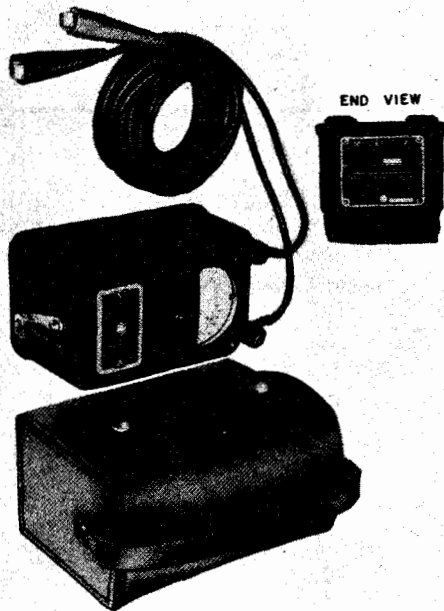

*Insulation Resistance Tester, OCW*

## FUNCTIONAL DESCRIPTION

The OCW is a portable Insulation Resistance Tester designed to measure insulation resistance from 0 to 100 megohms. It consists of a handcrank generator which provides 500 volts direct current testing voltage at the terminal posts, and the meter indicates the resistance in megohms up to 100 megohms or infinity indicating the resistance of the insulation being tested is beyond the range of the meter.

No field changes in effect at time of preparation (4 September 1956).

## ELECTRICAL AND MECHANICAL CHARACTERISTICS

RESISTANCE RANGE: 0 to 100 megohms.

SCALE ACCURACY: 3% max tolerance.

VOLTAGE OUTPUT: 500 v DC.

TYPE RECTIFIER: (2) half-wave tubes.

### GENERATOR DATA

TYPE: Permanent magnet rotor, hand operated.

OUTPUT: 700 v AC min at 170 rpm.

## MANUFACTURER'S OR CONTRACTOR'S DATA

Holtzer-Cabot Div. of First Industrial  
Corp., Boston, Mass.  
Contract N5sr 9557.

## TUBE AND/OR CRYSTAL COMPLEMENT

(2) 2B25(including 1 spare)

Total Tubes: (2)

## REFERENCE DATA AND LITERATURE

NAVSHIPS 900,726: Technical Manual for  
Insulation Resistance Tester OCW.

TYPE CLASSIFICATION
DESIGN COGNIZANCE BUSHIPS
PROCUREMENT COGNIZANCE
STOCK NO.
R.D.B. IDENT. NO.

## SHIPPING DATA

NUMBER OF BOXES	CONTENTS AND IDENTIFICATION	VOLUME (Cu.Ft.)	OVERALL DIMENSIONS (inches)	WEIGHT PACKED (lbs.)
1	Insulation Resistance Tester NT-60142 including: (1) Case (1) Test Lead, Red (1) Test Lead, Black (1) Spare Rectifier Tube (1) Spare Neon Lamp	0.27	6 X 8-1/4 X 9-3/4	7

UNCLASSIFIED

4.6 OCW: 1

OCW

**INSULATION RESISTANCE TESTER**

**EQUIPMENT SUPPLIED DATA**

QUANTITY PER EQUIPT	NAME AND NOMENCLATURE	OVERALL DIMENSIONS (inches)	WEIGHT (lbs.)
1	Insulation Resistance Tester NT-60142	3-3/8 X 3-3/8 X 6-1/2	2.9
1	Case, Carrying	4-1/8 X 5-5/16 X 7-1/2	
1	Test Lead, Red	121-3/4 lg	0.25
1	Test Lead, Black	121-3/4 lg	0.25
1	Spare Rectifier Tube	11/16 dia X 2	
1	Spare Neon Lamp	1/4 dia X 1	0.314 OZ

December 1956

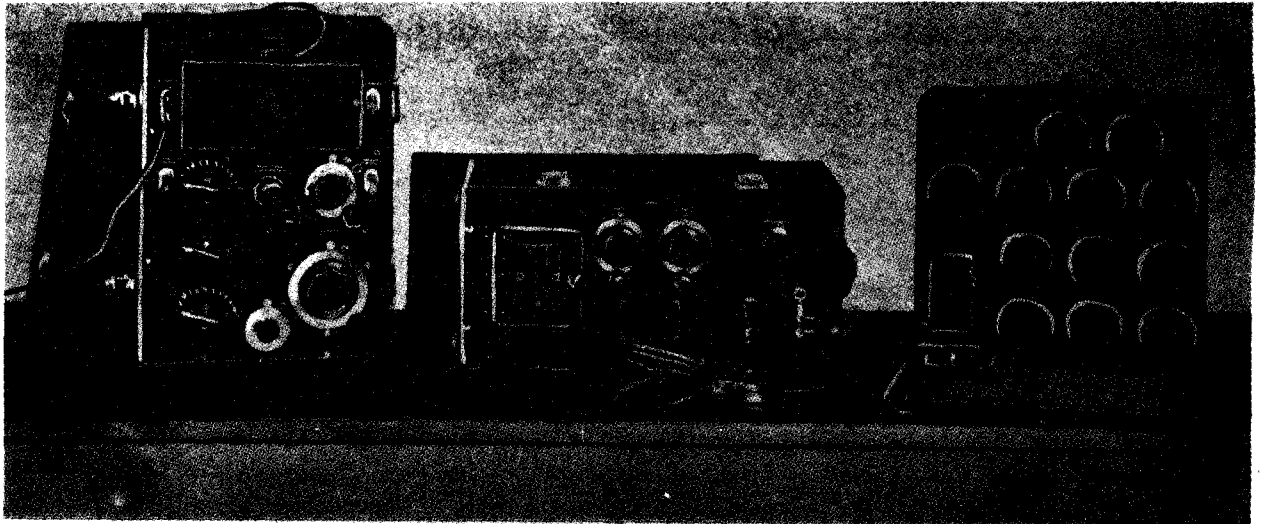
**RADIO FREQUENCY IMPEDANCE  
MEASURING EQUIPMENT****OH,OH-1***Radio Frequency Impedance Measuring Equipment OH, OH-1***FUNCTIONAL DESCRIPTION**

The OH and OH-1 is an equipment for measuring the impedance of inductors, capacitors, resistor, antennas, transmission lines, and radio trunk lines. The radio frequency bridge furnished as part of this equipment performs the actual impedance measurements, the heterodyne frequency meter indicates bridge balance, and an accessory box provides coils to cover the entire frequency range.

No field changes in effect at time of preparation (2 August 1956).

**RELATION TO OTHER EQUIPMENT**

Equipment Required but not Supplied: (1) Signal Generator, or RF Oscillator.

**ELECTRICAL AND MECHANICAL CHARACTERISTICS****RF BRIDGE**

FREQUENCY RANGE: 25 to 5520 kc, 13 bands (plug-in-coils).

RESISTANCE: 0.1 to 311 ohms.

CAPACITIVE REACTANCE: 0.016 to 58,000 ohms.

**ACCURACY**

RESISTANCE:  $\pm 2\%$  to  $3\%$ .

REACTANCE:  $\pm 1\%$  or  $\pm 5$  uuf in capacitance, whichever is greater.

RF POWER INPUT: Standard signal generator.

**HETERODYNE DETECTOR**

FREQUENCY RANGE: 25 to 5000 kc in thirteen ranges.

AUDIO OUTPUT: High or low impedance head-

set.  
OPERATING POWER: 115 v, 60 cps, 1 ph, 20 W.

**MANUFACTURER'S OR CONTRACTOR'S DATA**

(OH) General Radio Co., Cambridge, Mass.  
Contract NOs-72189, dated 7 March 1940.

Approximate Cost: \$200.00 with equipment spares.

(OH)-1) General Radio Co., Cambridge, Mass.  
Contract NOs-86008, dated 20 May 1941.

Approximate Cost: \$200.00 with equipment spares.

**TUBE AND/OR CRYSTAL COMPLEMENT**

(1) 6J7G (1) 6X5G (2) 6J5G (1) OC3  
Total Tubes: (5)

**REFERENCE DATA AND LITERATURE**

NAVSHIPS 95181: Technical Manual for Radio Frequency Impedance Measuring Equipment OH.

Technical Manual for Radio Frequency Impedance Measuring Equipment OH-1.

<b>TYPE CLASSIFICATION</b> DESIGN COGNIZANCE BUSHIPS PROCUREMENT COGNIZANCE STOCK NO. R.D.B. IDENT. NO.
---

OH,OH-1

## RADIO FREQUENCY IMPEDANCE MEASURING EQUIPMENT

December 1956

### SHIPPING DATA

NUMBER OF BOXES	CONTENTS AND IDENTIFICATION	VOLUME (Cu.Ft.)	OVERALL DIMENSIONS (inches)	WEIGHT PACKED (lbs.)
1	RF Impedance-Measuring Equipment OH or OH-1			
1	Spare Parts			

### EQUIPMENT SUPPLIED DATA

QUANTITY PER EQUIPT	NAME AND NOMENCLATURE	OVERALL DIMENSIONS (inches)	WEIGHT (lbs.)
1	RF Bridge NT-60009	9-1/2 X 13-1/4 X 17-3/4	25
1	Heterodyne Detector NT-46094	10-1/8 X 12-1/2 X 20-1/2	38
1	Accessory Box NT-10046	6-3/4 X 14-1/2 X 14-1/2	26
1	Set Equipment Spares		29

December 1956

## AUDIO FREQUENCY IMPEDANCE MEASURING EQUIPMENT

OJ,1,2,3

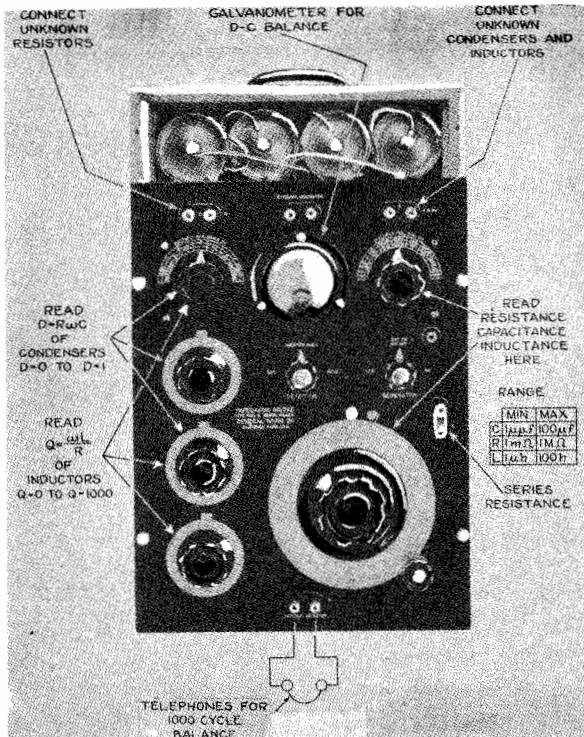

*Audio Frequency Impedance  
Measuring Equipment OJ,1*

### FUNCTIONAL DESCRIPTION

The OJ, 1, 2, or 3 is a self-contained bridge-type instrument for making measurements of DC resistance, AC resistance, capacitance, and dissipation factor, and inductance and energy factor.

No field changes in effect at time of preparation (2 August 1956).

### RELATION TO OTHER EQUIPMENT

The OJ, 1, 2, and 3 are the same as General Radio Company Model 650-A.

Equipment Required but not Supplied: (1) Head-phone.

### ELECTRICAL AND MECHANICAL CHARACTERISTICS

FREQUENCY: 1000  $\pm$ 50 cps.

### ACCURACY

RESISTANCE:  $\pm$ 0.002 ohms to  $\pm$ 2%.  
CAPACITANCE:  $\pm$ 2 uuf to  $\pm$ 2%.  
DISSIPATION FACTOR: +5% to +20%.  
INDUCTANCE:  $\pm$ 2% to 10%.  
ENERGY FACTOR:  $\pm$ 5% to  $\pm$ 20%.

### RANGES

RESISTANCE: 0.001 ohm to 1 meg.  
CAPACITANCE: 1 uuf to 100 uf.  
DISSIPATION FACTOR: 0.002 to 1 ohm.  
INDUCTANCE: 1 uh to 100 h.  
ENERGY FACTOR: 0.02 to 1000.

OPERATING POWER: Internal batt; 4 Eveready No. 6 ( or equiv).

### MANUFACTURER'S OR CONTRACTOR'S DATA

General Radio Co., Cambridge, Mass.  
(OJ-1) Contract NOS-86899, dated 4 June 1941.  
(OJ-2) Contract NXs-4888, dated 8 May 1942.  
(OJ-3) NObsr-30123.  
Approximate Cost \$300.00 with equipment spares.

### TUBE AND/OR CRYSTAL COMPLEMENT

No Electron Tubes.

### REFERENCE DATA AND LITERATURE

NAVSHIPS 95183: Technical Manual for Audio Frequency Impedance Measuring Equipment OJ-1.  
NAVSHIPS 95184: Technical Manual for Audio Frequency Impedance Measuring Equipment OJ-2.  
NAVSHIPS 900,994: Technical Manual for Audio Frequency Impedance Measuring Equipment OJ-3.

TYPE CLASSIFICATION
DESIGN COGNIZANCE BUSHIPS
PROCUREMENT COGNIZANCE
STOCK NO.
R.D.B. IDENT. NO.

### EQUIPMENT SUPPLIED DATA

QUANTITY PER EQUIP	NAME AND NOMENCLATURE	OVERALL DIMENSIONS (inches)	WEIGHT (lbs.)
1	AF Impedance Measuring Equipment OJ, 1, 2, or 3	8-1/2 X 12 X 20	31-1/4

## CONCENTRIC LINE STANDING WAVE MEASURING EQUIPMENT

OT, OT-1

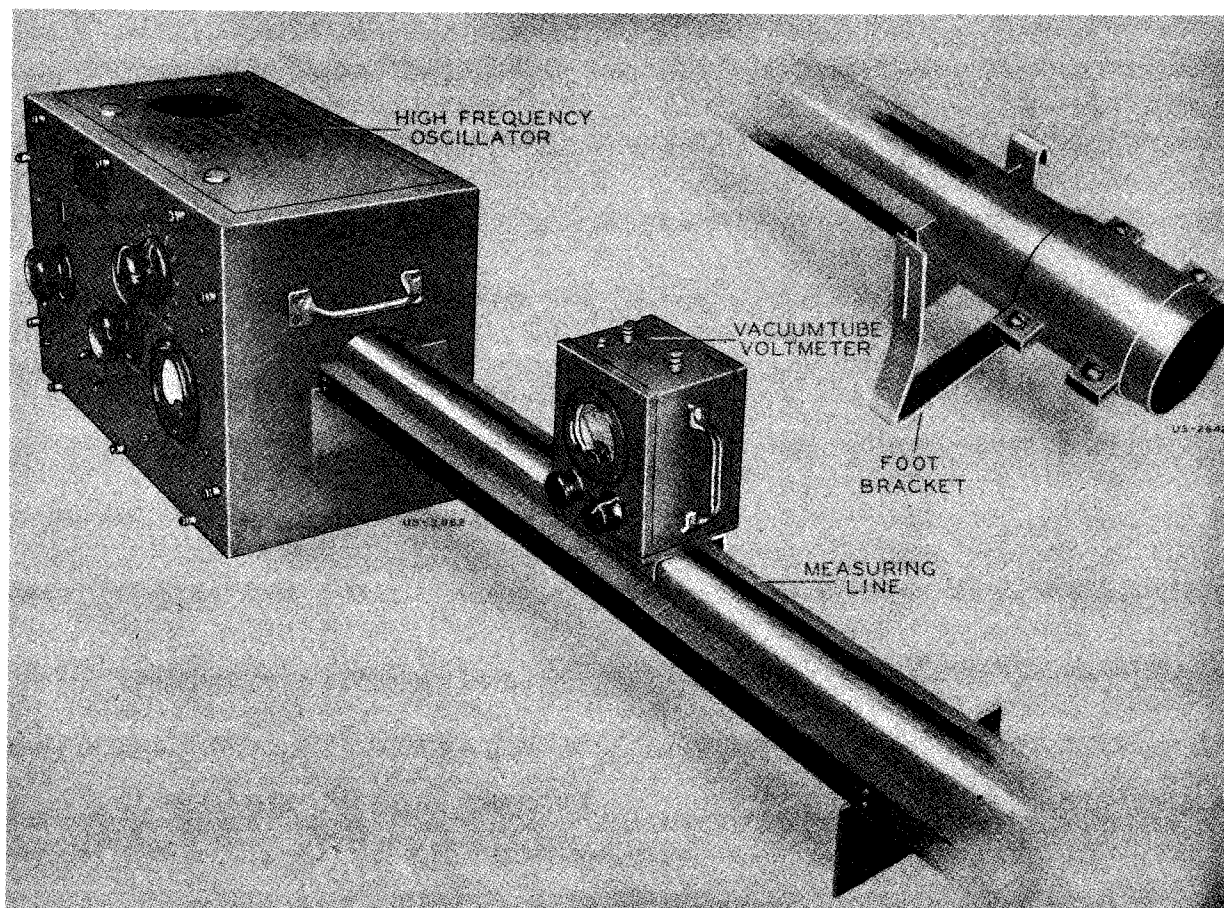

*Concentric Line Standing Wave Measuring Equipment Navy Model OT*

### FUNCTIONAL DESCRIPTION

The Concentric Line Standing Wave Measuring Equipment Navy Model OT and OT-1 are designed to measure the voltage standing wave ratio of concentric transmission lines with their components, in the frequency range of 100 to 225 mc. The complex impedance of antennas can be determined from measurements of the standing wave ratio and from the location of the voltage maximum or minimum points. The equipment consists of an oscillator and power supply, a voltage probe and a concentric slotted line. The concentric line kit includes inner connectors of various diameters to provide for different characteristic impedances.

No field changes in effect at time of preparation (11 April 1958).

### ELECTRICAL AND MECHANICAL CHARACTERISTICS

FREQUENCY RANGE: 100 to 225 mc.

LINE IMPEDANCE: 40, 50, 63, 70 ohms.

#### POWER REQUIREMENTS

RECTIFIER POWER UNIT: 117 v, 60 cps,  
single ph, 300 W.

PROBE VOLTMETER: 1.5 v battery.

EMISSION: Sine wave.

### MANUFACTURER'S OR CONTRACTOR'S DATA

RCA Victor Division of Radio Corporation  
of America, Camden, N.J.

Contract NOs-98829, dated 11 February  
1942.

Contract NOs-99649, dated 5 March 1942



Test-Impedance and Standing Wave Ratio

OT, OT-1

**CONCENTRIC LINE STANDING WAVE  
MEASURING EQUIPMENT**

**TUBE AND/OR CRYSTAL COMPLEMENT**

(2) 826                      (2) 816                      (1) 957  
Total Tubes: (5)  
No Crystals used.

TYPE CLASSIFICATION  
DESIGN COGNIZANCE BUSHIPS  
PROCUREMENT COGNIZANCE  
STOCK NO.  
R.D.B. IDENT. NO. 6.2.1

**REFERENCE DATA AND LITERATURE**

NAVSHIPS 95193: Concentric Line Standing  
Wave Measuring Equipment Models OT/OT-1.

**EQUIPMENT SUPPLIED DATA**

QUANTITY PER EQUIPT	NAME AND NOMENCLATURE	OVERALL DIMENSIONS (inches)	WEIGHT (lbs.)
1	Rectifier Power Unit NT-20133	9-1/16 x 11-3/8 x 20-3/4	70
1	Oscillator Unit NT-35006	11-1/8 x 11-15/16 x 19-3/4	30
1	Measuring Line Kit	3-1/8 dia x 80	77
1	Vacuum Tube Voltmeter NT-60027	4 x 5 x 6	4
1	Inter Unit Power Cable	20 ft lg	
1	Power Cable	15 ft lg	
1	Set of Spare Parts		

UNCLASSIFIED

April 1958

Test-Impedance and/or Standing Wave Ratio

## STANDING WAVE INDICATOR

TS-12/AP

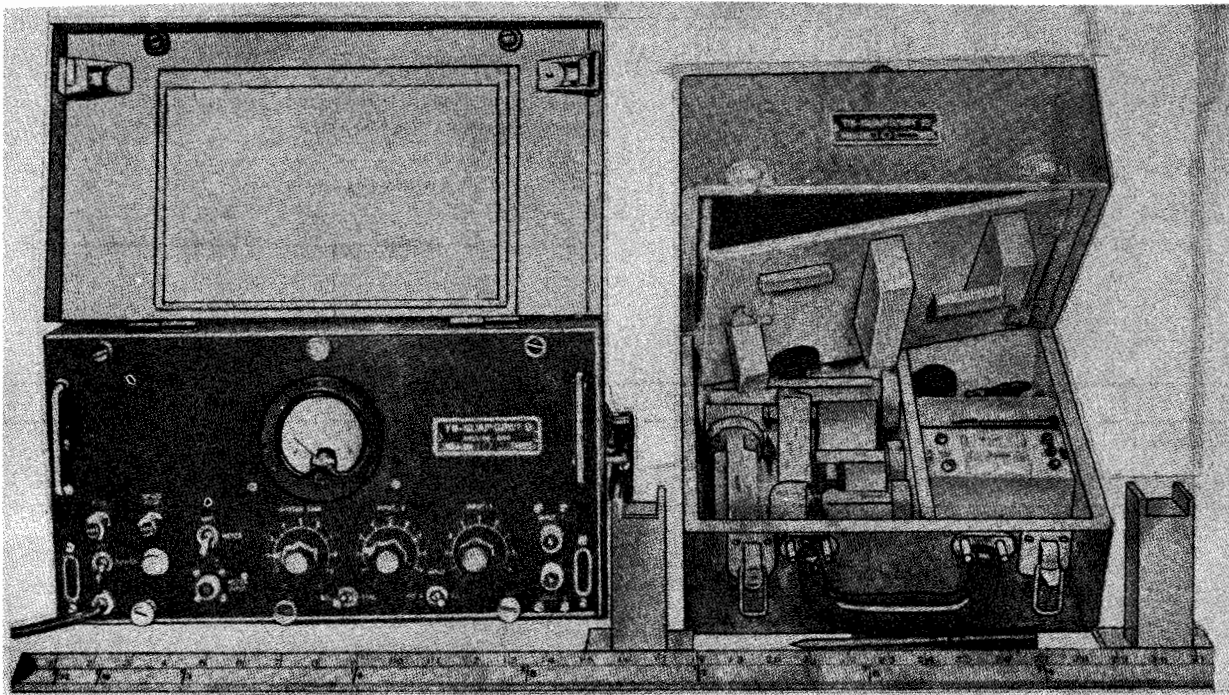

*Standing Wave Indicator TS-12/AP*

### FUNCTIONAL DESCRIPTION

The TS-12/AP is a portable equipment designed specifically for testing radar plumbing, TR and RT boxes, crystal mixers, and antennas. Voltage standing wave ratios are directly calibrated on the output meter. The TS-12/AP must be used in conjunction with a source of pulsed RF power such as Radio Frequency Test Set TS-13/AP at 9305 to 9445 mc.

No field changes in effect at time of prepatation (31 March 1958).

### RELATION TO OTHER EQUIPMENT

Equipment Required but not Supplied: (1) Radio Frequency Test Set TS-13/AP or equal.

### ELECTRICAL AND MECHANICAL CHARACTERISTICS

FREQUENCY RANGE: 9305 to 9445 mc.  
PULSE RATE FREQUENCY: 400 to 3500 cps.

ACCURACY:  $\pm 3\%$  approx.  
SENSITIVITY: 15 uv min.  
AMBIENT TEMPERATURE RANGE: 0 to 120° F.  
INPUT IMPEDANCE: Square-law pickup to 50 ohms.  
POWER REQUIREMENTS: 115 v, 1 ph, 60 to 800 cps, 35 W.

### MANUFACTURER'S OR CONTRACTOR'S DATA

Presto Recording Corp., New York, N. Y.  
Contract N5sr-8658.  
Approximate Cost: \$1,000.00 with equipment spares.

### TUBE AND/OR CRYSTAL COMPLEMENT

(1) 6X5WGT	(1) 6V6GT
(2) 6SJ7	(1) 6H6
Total Tubes: (5)	
(2) 1N21	
Total Crystals: (2)	

UNCLASSIFIED

4.6 TS-12/AP: 1

April 1958

Test-Impedance and/or Standing Wave Ratio

TS-12/AP

## STANDING WAVE INDICATOR

## REFERENCE DATA AND LITERATURE

AN16-35TS12-3: Technical Manual of Maintenance Instructions for Model TS-12/AP Test Equipment.

TYPE CLASSIFICATION DESIGN COGNIZANCE BUSHIPS PROCUREMENT COGNIZANCE STOCK NO. R.D.B. IDENT. NO.
--

## EQUIPMENT SUPPLIED DATA

QUANTITY PER EQUIPT	NAME AND NOMENCLATURE	OVERALL DIMENSIONS (inches)	WEIGHT (lbs.)
1	Standing wave Indicator TS-12/AP consisting of		60.0
1	Amplifier Unit (Unit 1)	8-7/8 X 9 X 16-5/8	36.0
1	Accessories Case (Unit 2) containing:	7-3/8 X 9 X 11-5/8	16.5
2	Adapter UG-81/U		
1	RF Cable CG-92/U		
1	Synch Cable CG-91/U		
1	Synch Cable CG-89/U		
1	Adapter UG-79/U		
1	Slotted Section CG-87/U		
1	Probe Assembly MX-158/U		
1	Terminating Section CG-88/U		
1	Adapter CG-90/U		
1	Adapter UG-80/U		
2	Support Blocks		
6	Crystal 1N21 (spares)		
1	Set Screwdrivers		
4	"C" Clamps (1 in.)		
2	Spare Probe Conductors		
1	Set of Spares		

December 1956

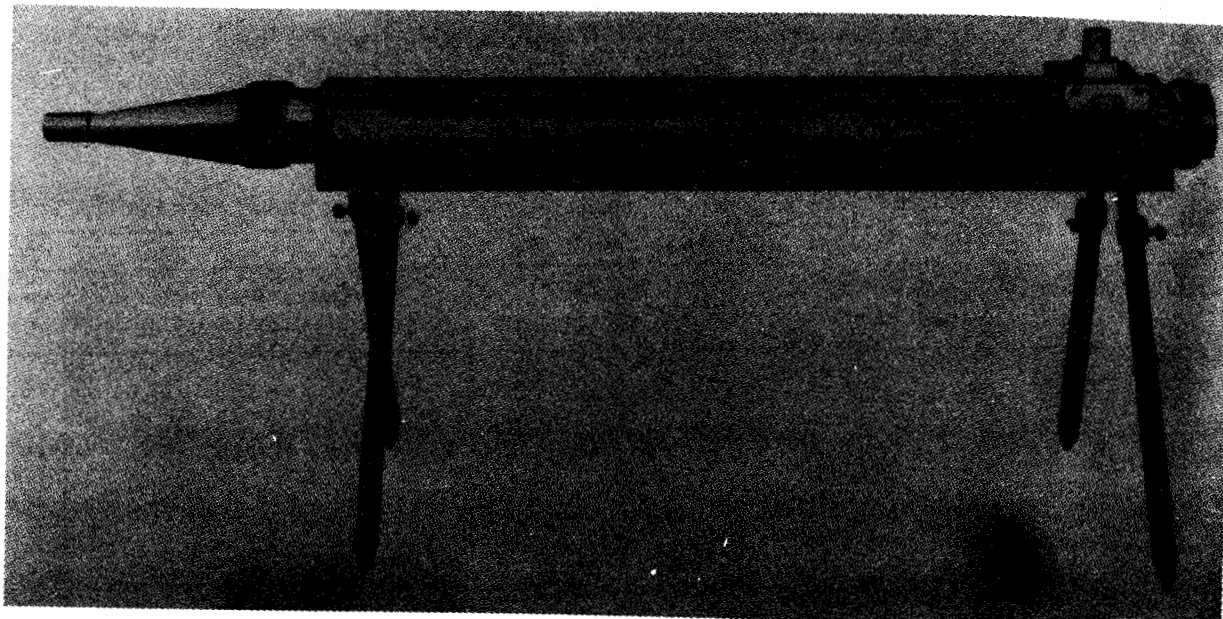
**STANDING WAVE METER****TS-130/UP***Standing Wave Meter TS-130/UP***FUNCTIONAL DESCRIPTION**

The TS-130/UP is a slotted coaxial line of known characteristic impedance used in measuring standing wave ratios and RF impedances. It is primarily intended for measurements of radar equipments operating in the 400 to 3000 megacycle frequency range such as the MK 20 and AN/CPS-5 radar equipments, but is capable of functioning over a frequency range of about 400 to 3400 megacycles. Its principal application is detection of any serious impedance irregularities in radar transmission systems. It is provided with detachable adjustable legs and transmission line calculators for computing impedances.

No field changes in effect at time of preparation (9 July 1956).

**RELATION TO OTHER EQUIPMENT**

Equipment Required but not Supplied: (1) Test Set TS-96/TPS-1 or equivalent, (1) Signal Generator TS-128/UP or equivalent.

**ELECTRICAL AND MECHANICAL CHARACTERISTICS**

FREQUENCY RANGE (OPERATING): Approx 400 to 3400 mc.  
 IMPEDANCE: 53.5 ohm.  
 PRESENTATION: 4 to 53 ohm scale.

**MANUFACTURER'S OR CONTRACTOR'S DATA**

Western Electric Co. Inc., New York, N.Y.  
 Contracts NOrd-3456, dated 2 Feb. 1945,  
 NOrd-10095, dated 27 June 1947,  
 MIPR-H3051, dated 9 Oct. 1953.  
 Approximate Cost: \$2250.00 with equipment spares.

**TUBE AND/OR CRYSTAL COMPLEMENT**

No Electron Tubes.

**REFERENCE DATA AND LITERATURE**

NAVSHIPS 900,538: Technical Manual for TS-130/UP Standing Wave Meter.

TYPE CLASSIFICATION	
DESIGN COGNIZANCE	BUSHIPS.
PROCUREMENT COGNIZANCE	
STOCK NO.	
R.D.B. IDENT. NO.	

TS-130/UP

## STANDING WAVE METER

December 1956

## EQUIPMENT SUPPLIED DATA

QUANTITY PER EQUIPT	NAME AND NOMENCLATURE	OVERALL DIMENSIONS (inches)	WEIGHT (lbs.)
1	Standing Wave Meter TS-130/UP	3-1/2 X 3-3/4 X 29-1/2*	13.5
2	Transmission Line Calculator	9-1/4 X 10-1/2	

Note: \*Dimensions do not include legs.

UNCLASSIFIED

Test-Impedance and Standing Wave Ratio

March 1957

## STANDING WAVE METER

TS-130A/UP

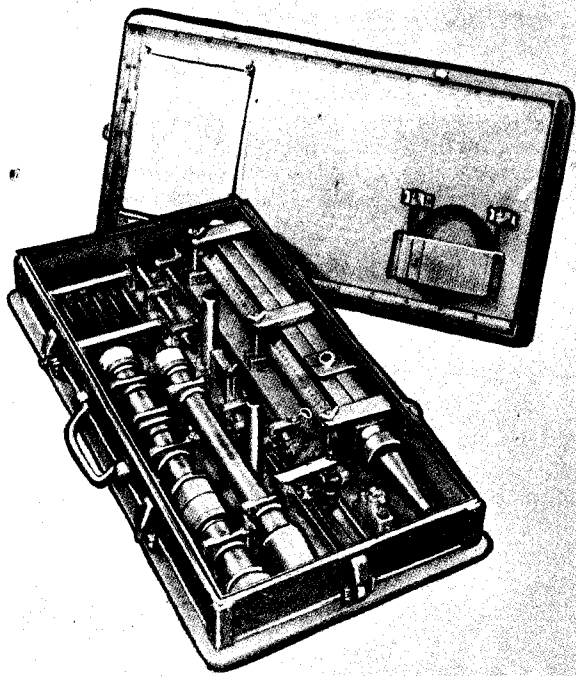

Type TS-130A/UP Standing Wave Meter

### RELATION TO OTHER EQUIPMENT

Equipment Required but not Supplied: (1) Signal source such as Signal Generator TS-419/U or TS-128/UP or Radar Transmitter. (1) Indicating Device such as Indicator-Amplifier TS-12/AP (Unit 1) or a Sensitive Microammeter or light-beam galvanometer. (1) Terminating device such as a dummy load or antenna. The following is required, Crystal Rectifier IN21B or IN23B, Bolometer 610A and patch cords.

### ELECTRICAL AND MECHANICAL CHARACTERISTICS

FREQUENCY RANGE: 400 to 3000 mc.  
INPUT IMPEDANCE: 52 ohms.  
OPERATING TEMPERATURE RANGE:  $-40^{\circ}\text{F}$  to  $+122^{\circ}\text{F}$ .  
ACCURACY:  $\pm 5\%$ .

### MANUFACTURER'S OR CONTRACTOR'S DATA

Central Research Laboratories, Inc., Red Wing, Minnesota.  
Contract MIPR-R-54-884-43051.

### TUBE AND/OR CRYSTAL COMPLEMENT

No Electron Tubes.

### REFERENCE DATA AND LITERATURE

Technical Manual for Standing Wave Meter TS-130A/UP.

### FUNCTIONAL DESCRIPTION

The TS-130A/UP is a portable test set which is used for sampling and measuring the electrical field within coaxial transmission lines or waveguides carrying radio frequencies ranging from 400 to 3000 megacycles per second. These measurements enable an accurate evaluation of the standing wave pattern within the transmission line and provide the basic information from which such characteristics as VSWR, characteristic impedance of transmission line components and wave length and frequency of transmitted RF energy can be determined.

The Standing Wave Meter consists primarily of a precision slotted line assembly, two RF test probes and various sections of inner and outer coaxial conductors which serve as adapters for connecting the slotted line assembly to the transmission line or component under test.

No field changes in effect at time of preparation (23 August 1956).

TYPE CLASSIFICATION
DESIGN COGNIZANCE USAF
PROCUREMENT COGNIZANCE
STOCK NO.
R.D.B. IDENT. NO.

UNCLASSIFIED

4.6 TS-130A/UP: 1

## TS-130A/UP

## STANDING WAVE METER

March 1957

EQUIPMENT SUPPLIED DATA			
QUANTITY PER EQUIPT	NAME AND NOMENCLATURE	OVERALL DIMENSIONS (inches)	WEIGHT (lbs.)
1	Slotted Line Assembly IM-34/U		
1	*R-F Test Probe MX-1019/U		
1	*R-F Test Probe MX-1020/U		
1	Cord Assembly CG-266/U		
1	Inner Adjustable Conductor Assembly		
1	Cord Assembly CG-281/UP		
1	Cord Sleeve Assembly		
1	Connector Adapter Assembly UG-539/U		
1	Connector Adapter Inner Conductor		
1	Connector Adapter Assembly UG-540/U		
1	Cord CG-426/U		
2	Smith Impedance or Admittance Coordinates Chart		
1	Case Assembly CY-791/U		

\* One each r-F adapter mount assembly and crystal and bolometer mount assembly supplied with each r-F test probe.



TEST SET

TS-299/UP

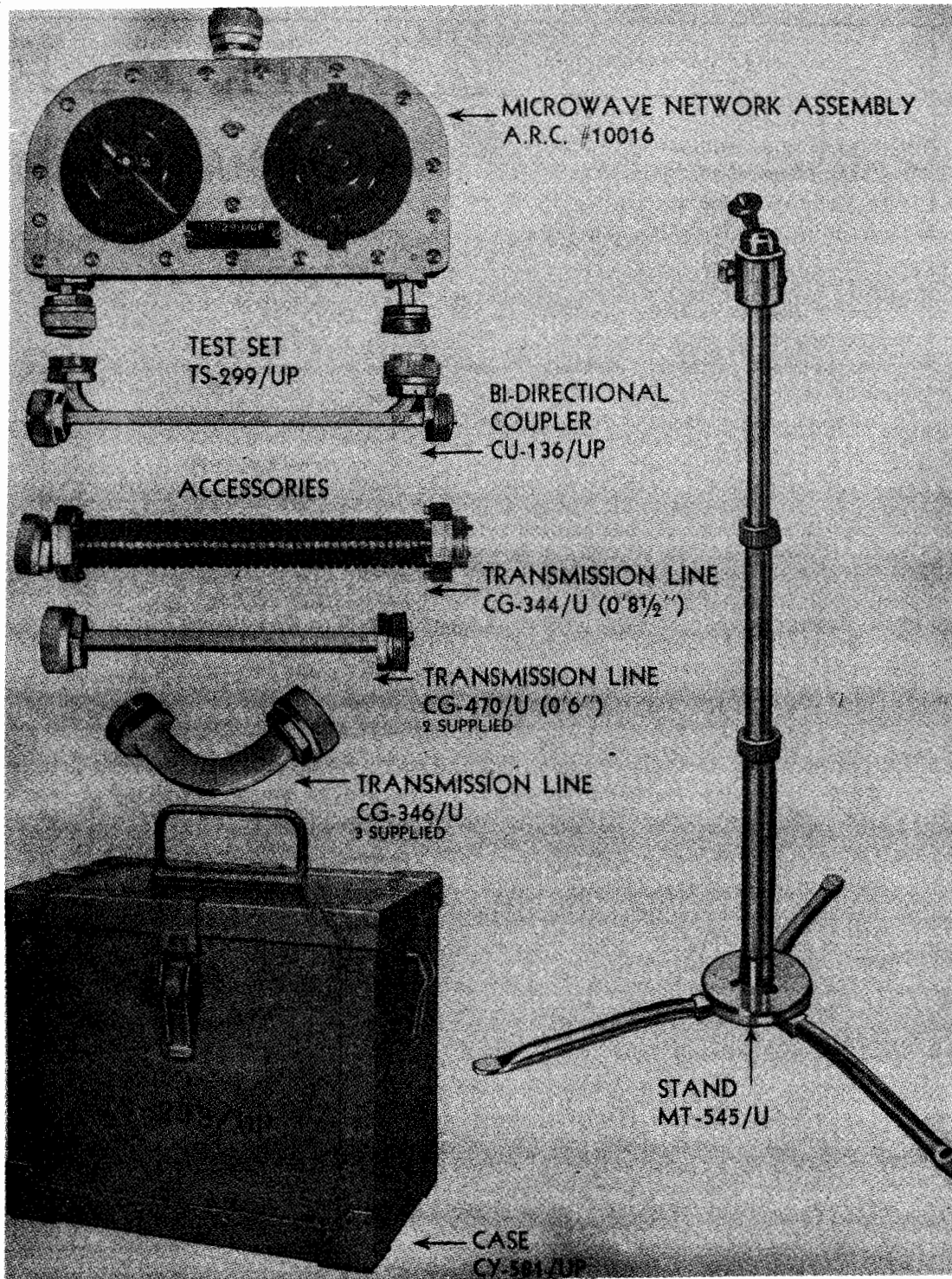

Test Set TS-299/UP



Test-Impedance and Standing Wave Ratio

**TS-299/UP**

**TEST SET**

**FUNCTIONAL DESCRIPTION**

The TS-299/UP is used in field or laboratory measurement of voltage standing-wave ratios.

No field changes in effect at time of preparation (25 April 1958).

**RELATION TO OTHER EQUIPMENT**

Equipment Required but not Supplied: (1) Radar Transmitting Equipment, (1) Power Meter TS-254/AP.

**ELECTRICAL AND MECHANICAL CHARACTERISTICS**

FREQUENCY RANGE: 23, 500 to 24,500 mc.  
POWER RANGE: 10 W to 100 KW (peak).  
ACCURACY:  $\pm 10\%$ (VSWR);  $\pm 0.5$  db (pwr).

**MANUFACTURER'S OR CONTRACTOR'S DATA**

Aircraft Radio Corp, Boonton, N.J.  
Contract N5sa-13620.

**TUBE AND/OR CRYSTAL COMPLEMENT**

No Electron Tubes or Crystals used.

**REFERENCE DATA AND LITERATURE**

AN16-35TS299-3: Handbook of Maintenance Instructions for Test Set TS-299/UP.

TYPE CLASSIFICATION
DESIGN COGNIZANCE BUAER
PROCUREMENT COGNIZANCE
STOCK NO.
R.D.B. IDENT. NO.

**EQUIPMENT SUPPLIED DATA**

QUANTITY PER EQUIPT	NAME AND NOMENCLATURE	OVERALL DIMENSIONS (inches)	WEIGHT (lbs.)
1	Test Set TS-299/UP including:		
1	Microwave Network Assy (A.R.C.#10016) consisting of	2-1/2 x 8-1/2 x 8-3/4	3.7
1	Bi-directional Coupler CU-136/UP		
1	Case CY-581/UP	8-1/2 x 10-1/4 x 13-1/4	10.0
3	Transmission Lines CG-346/U	1-1/8 x 2-5/8 x 2-1/2	
2	Transmission Lines CG-470/U (6 in.)	1-1/8 x 1-1/8 x 6-3/32	
1	Transmission Line CG-344/U (8-1/2 in.)	1-1/4 x 1-7/16 x 8-19/32	
1	Stand, Folding, 2 ft high MT-545/U	2-3/8 x 3 x 11	

UNCLASSIFIED

January 1958

Test-Impedance and Standing Wave Ratio  
**SLOTTED SECTION AND PROBE**

**TS-339/UP**

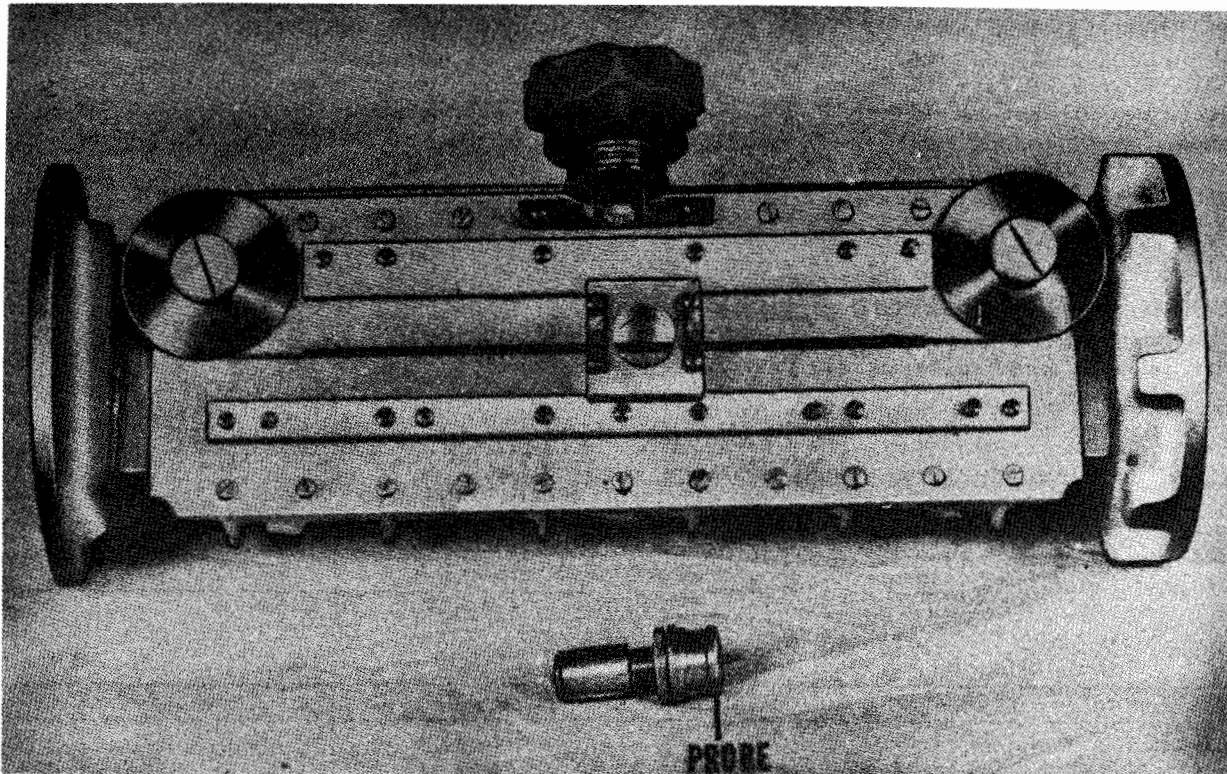

*Slotted Section and Probe - TS-339/UP*

**FUNCTIONAL DESCRIPTION**

The TS-339/UP is designed primarily for use with AEW systems for measuring the VSWR of high power radar equipment when the TS-125/AP Power Meter is used as an indicator. It consists of a slotted section and probe. The slotted section of 1-1/2 by 3 inch waveguide terminates on one end in a choke flange coupling and on the other end in a plain flange coupling, while the probe moves along the slot.

No field changes in effect at time of preparation (15 July 1957).

**ELECTRICAL AND MECHANICAL CHARACTERISTICS**

FREQUENCY RANGE: 2770 to 2900 mc.

**TUBE AND/OR CRYSTAL COMPLEMENT**

No Electron Tubes.

**REFERENCE DATA AND LITERATURE**

NAVAER 08-5S-78: Manual of Test Equipment for Airborne Electrical and Electronic Equipment.

TYPE CLASSIFICATION
DESIGN COGNIZANCE BUAER
PROCUREMENT COGNIZANCE
STOCK NO.
R.D.B. IDENT. NO. 6.2.1

**EQUIPMENT SUPPLIED DATA**

QUANTITY PER EQUIPT	NAME AND NOMENCLATURE	OVERALL DIMENSIONS (inches)	WEIGHT (lbs.)
1	Slotted Section and Probe TS-339/UP	6 x 6 x 12	26

UNCLASSIFIED

4.6 TS-339/UP: 1

**REFLECTOMETER  
(BI-DIRECTIONAL COUPLER)**

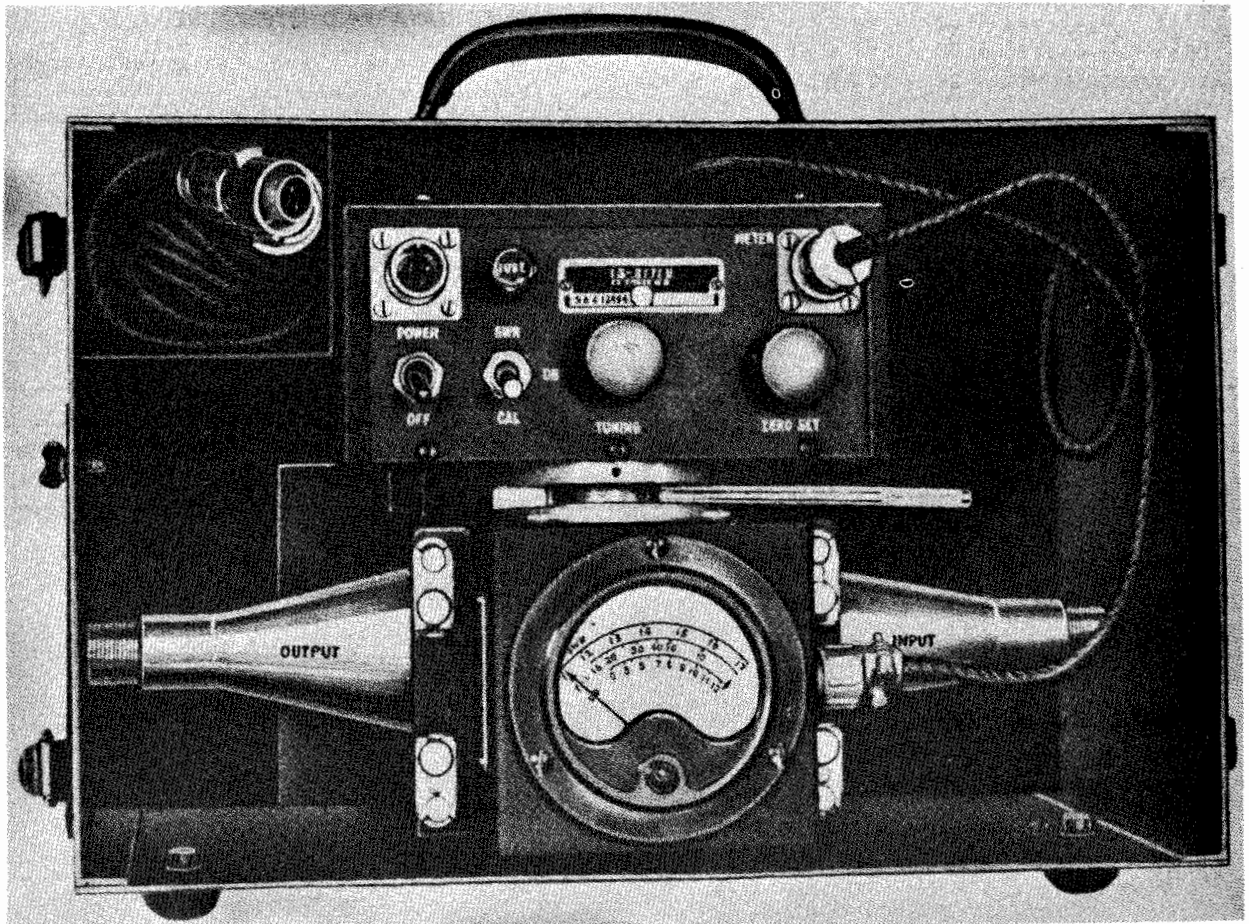

*Reflectometer (Bi-Directional Coupler) TS-377/U*

**FUNCTIONAL DESCRIPTION**

The TS-377/U is a ground test set equipment used in checking or determining the voltage standing wave ratio and relative output power in the RF transmission line between a transmitter or signal source and its antenna or load to perform a check suitable in determining how well the transmission line and antenna are matched.

It is usually used for checking Radio Transmitter T-123/ART-22, although it may be used for checking any signal source whose frequency range is 275 to 330 megacycles at average power outputs exceeding 5 watts or 250 to 365 megacycles at average power outputs exceeding 10 watts.

No field changes in effect at time of preparation (6 September 1957).

**ELECTRICAL AND MECHANICAL CHARACTERISTICS**

**FREQUENCY RANGE (AT AVERAGE POWER OUTPUT)**

5 W MIN: 275 to 330 mc.

10 W MIN: 250 to 365 mc.

**VSWR ACCURACY (WHEN TERMINATED WITH MATCHED LOAD)**

275 to 330 MC: 1.2 max reading.

250 to 365 MC: 1.3 max reading.

**POWER MEASUREMENT ACCURACY**

275 to 330 MC: 0.5 db max.

250 to 365 MC:  $\pm 1$  db max.

**LINE VOLTAGE VARIATION ACCURACY**

**REFLECTOMETER  
(BI-DIRECTIONAL COUPLER)**

VSWR: 0.05 max from 28 v, +2 v or -4 v.  
DB: 0.5 max from 28 v, +2 v or -4 v.  
POWER REQUIREMENTS: 24 to 30 v DC, 0.16 amps.

**REFERENCE DATA AND LITERATURE**

NAVAER 16-5S-512: Technical Manual for Reflectometer TS-377/U.

**TUBE AND/OR CRYSTAL COMPLEMENT**

(2) 9002  
Total Tubes: (2)

TYPE CLASSIFICATION DESIGN COGNIZANCE BUAER PROCUREMENT COGNIZANCE STOCK NO. R.D.B. IDENT. NO. 6.2.2
--

**EQUIPMENT SUPPLIED DATA**

QUANTITY PER EQUIPT	NAME AND NOMENCLATURE	OVERALL DIMENSIONS (inches)	WEIGHT (lbs.)
1	Reflectometer TS-377/U	6-5/8 lg X 7-3/4 w	6.3
1	Covering Case	7-5/8 X 8-3/8 X 14-1/4	12.4
1	Meter Case Assembly including: Meter Cable	2-11/16 X 3-7/8 X 5-3/4 42 lg	1.6
1	Power Cable	120 lg	0.6
1	RF Cable RG-9/U	48 lg	
1	Bi-Female Junction Connector	5/8 dia X 2-3/16	

UNCLASSIFIED

September 1956

Impedance and Standing Wave Ratio Measuring Equipment

# CAPACITY AND RESISTANCE BRIDGE

**TS-415/U**  
**(NT-60007)**

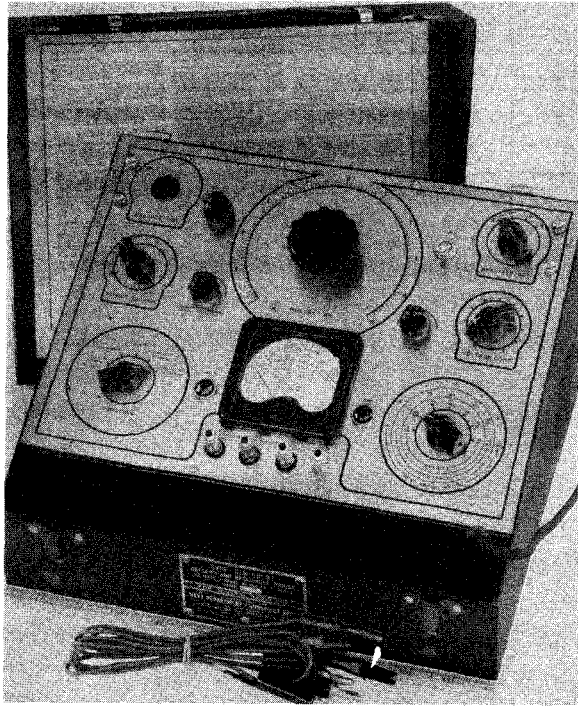

*Capacity and Resistance Bridge TS-415/U*

## FUNCTIONAL DESCRIPTION

The TS-415/U(NT-60007) is a self-contained portable equipment. It is a low frequency bridge for the measurement of capacitance, resistance and transformer turns ratio. It contains facilities for polarizing electrolytic condensers while their capacitance and power factor are being determined and also for measuring their direct leakage current. Insulation resistance can be determined up to 2500 megohms.

## RELATION TO OTHER EQUIPMENT

This equipment has been superseded by Capacitance-Inductance-Resistance Bridge

ZM-11/U which is physically smaller and lighter and performs more functions.

## ELECTRICAL AND MECHANICAL CHARACTERISTICS

POWER SUPPLY: 115 v AC, 50 to 60 cps, 35 W.  
RANGES

CAPACITANCE: 10 uuf to 100 uf.

RESISTANCE: 1.0 ohm to 10. meg (reads to 10.0 meg with slightly less precision of balance).

TRANSFORMER TURNS RATIO: 0.001 to 1000.

INSULATION RESISTANCE: Up to 2500 meg.

POLARIZING VOLTAGE: 0 to 550 v DC.

ELECTROLYTIC LEAKAGE CURRENT: 0 to 1, 0 to 2.5 and 0 to 5 ma.

POWER FACTOR: 0 to 50%.

ACCURACY:  $\pm 5\%$  nominal.

## MANUFACTURER'S OR CONTRACTOR'S DATA

Clough-Brengle Co., Chicago, Illinois.

Contract NXsr-37247.

Contract NXs-4516, dated 14 September 1943.

Contract NXs-16844.

## TUBE AND/OR CRYSTAL COMPLEMENT

(1) 5U4-G            (1) 6SJ7            (1) 6E5  
Total Tubes: (3)

## REFERENCE DATA AND LITERATURE

NAVSHIPS 900,628: Technical Manual for NT 60007 Capacity and Resistance Bridge.

TYPE CLASSIFICATION
DESIGN COGNIZANCE BUSHIPS
PROCUREMENT COGNIZANCE
STOCK NO.
R.D.B. IDENT. NO.

## SHIPPING DATA

NUMBER OF BOXES	CONTENT $\ddot{s}$ AND IDENTIFICATION	VOLUME (Cu.Ft.)	OVERALL DIMENSIONS (inches)	WEIGHT PACKED (lbs.)
	R-C Bridge TS-415/U (NT-60007) and accessories	2.9		23.0

UNCLASSIFIED

4.6 TS-415/U: 1

TS-415/U  
(NT-60007)

## CAPACITY AND RESISTANCE BRIDGE

UNCLASSIFIED  
September 1956

## EQUIPMENT SUPPLIED DATA

QUANTITY PER EQUIPT	NAME AND NOMENCLATURE	OVERALL DIMENSIONS (inches)	WEIGHT (lbs.)
1	R-C Bridge TS-415/U (NT-60007)		
3	Test Leads	12 X 10-1/2 X 7-1/8	18.0
2	Instruction Books NavShips 900,628	72 1g	



UNCLASSIFIED

June 1957

Test-Impedance and Standing Wave Ratio

## ANALYZER

TS-415B/U

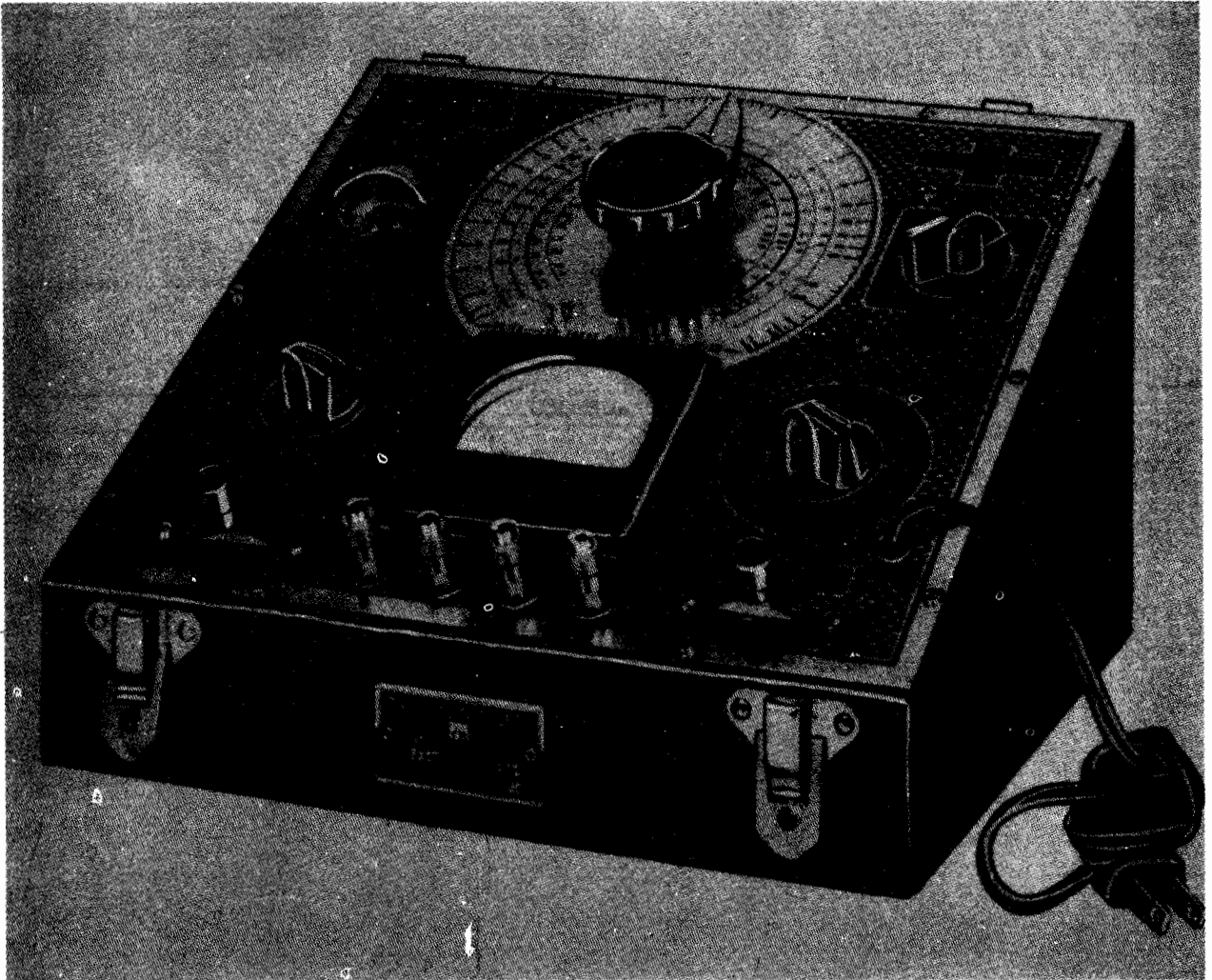

*Analyzer TS-415B/U*

### FUNCTIONAL DESCRIPTION

The TS-415B/U is used to check capacitors for intermittent, open-circuited, or short-circuited condition. It also measures capacitance, resistance, power factor and leakage current, and provides means to use the internal vacuum tube voltmeter for voltage measurements.

No field changes in effect at time of preparation (8 October 1956).

### RELATION TO OTHER EQUIPMENT

The TS-415B/U is identical to Solar Manu-

facturing Corporation Model CF-1-60 Examiner.

### ELECTRICAL AND MECHANICAL CHARACTERISTICS

#### RANGES

CAPACITANCE: 10 uuf to 1000 uuf.  
POWER FACTOR: 0 to 55%.  
LEAKAGE CURRENT: 0 to 5 ma.  
INSULATION RESISTANCE: 3 to 10,000 meg.  
RESISTANCE: 100 ohms to 7.5 meg.  
DC VTVM: 0 to 550 v, 3 ranges.  
AC VTVM: 10 to 50 v.  
OPERATING POWER: 115 v, 50 to 60 cps, single phase.

UNCLASSIFIED

4.6 TS-415B/U: 1

UNCLASSIFIED

June 1957

Test-Impedance and Standing Wave Ratio

**TS-415B/U**

**ANALYZER**

**MANUFACTURER'S OR CONTRACTOR'S DATA**

Solar Manufacturing Corporation, New York,  
N.Y.

Approximate Cost: \$200.00 with equip-  
ment apares.

TYPE CLASSIFICATION  
DESIGN COGNIZANCE TASSA  
PROCUREMENT COGNIZANCE  
STOCK NO.  
R.D.B. IDENT. NO.

**TUBE AND/OR CRYSTAL COMPLEMENT**

(2) 6J5G (1) 6L6

Total Tubes: (3).

**EQUIPMENT SUPPLIED DATA**

QUANTITY PER EQUIPT	NAME AND NOMENCLATURE	OVERALL DIMENSIONS (inches)	WEIGHT (lbs.)
1	Analyzer TS-415B/U	5-1/2 X 10 X 12-3/4	12.75



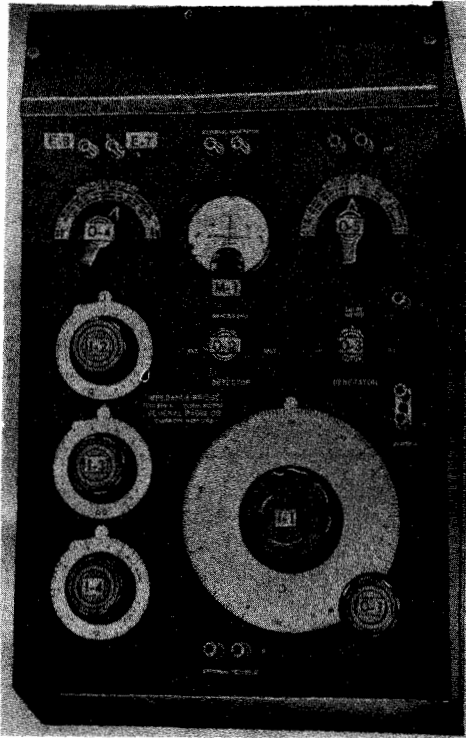

Impedance Bridge TS-460/U, OJ-3

### FUNCTIONAL DESCRIPTION

The TS-460/U (OJ-3) (General Radio Type 650-A) is designed to make direct measurement of resistance, capacitance, inductance, dissipation factor of capacitors and storage factor of inductors. The bridge has a built-in one kc signal source and a battery power supply.

No field changes in effect at time of preparation (25 June 1956).

### RELATION TO OTHER EQUIPMENT

The TS-460/U thru TS-460C/U are similar in design and function, however the TS-460 C/U supersedes the other series equipments, having improved ranges, greater accuracy and a portable drip proof metal case. The 460 B/U

is built in a metal cabinet and is designed for optional relay rack installation.

Equipment required but not supplied: (1) Headset NT-49507 or equivalent.

### ELECTRICAL AND MECHANICAL CHARACTERISTICS

#### RANGES

RESISTANCE: 1.0 milliohm to 1.0 meg,  $\pm 2\%$ .  
 CAPACITANCE: 1.0 uuf to 100 uf,  $\pm 2\%$ .  
 INDUCTANCE: 1.0 uh to 100 h,  $\pm 2\%$ ; increasing to 10% at 100 h.  
 DISSIPATION FACTOR: 0.02 to 1000,  $\pm 20\%$  or 0.005 which ever is greater.  
 STORAGE FACTOR: 0.02 to 1000,  $\pm 20\%$  to a value of 10.  
 FREQUENCY RANGE: 60 cps to 10 kc, from external generator.  
 INTERNAL SIGNAL SOURCE: 1.0 kc,  $\pm 10\%$ .  
 POWER REQUIREMENTS: 6 v DC from (4) battery BA-23.

### MANUFACTURER'S OR CONTRACTOR'S DATA

General Radio Co., Cambridge, Mass  
 Contract NObsr-30123

### TUBE AND/OR CRYSTAL COMPLEMENT

No Electron Tubes

### REFERENCE DATA AND LITERATURE

NAVSHIPS 900,994: Technical Manual for OJ-3  
 Impedance Bridge  
 NAVSHIPS 91402: Technical Manual for TS-460/U  
 Impedance Bridge.

TYPE CLASSIFICATION	
DESIGN COGNIZANCE	TASSA
PROCUREMENT COGNIZANCE	
STOCK NO.	
R.D.B. IDENT. NO.	

TS-460/U(OJ-3)

## IMPEDANCE BRIDGE

September 1956

## SHIPPING DATA

NUMBER OF BOXES	CONTENTS AND IDENTIFICATION	VOLUME (Cu.Ft.)	OVERALL DIMENSIONS (inches)	WEIGHT PACKED (lbs.)
1	Impedance Bridge TS-460/U or OJ-3	4.23		50

## EQUIPMENT SUPPLIED DATA

QUANTITY PER EQUIPT	NAME AND NOMENCLATURE	OVERALL DIMENSIONS (inches)	WEIGHT (lbs.)
1	Impedance Bridge TS-460/U or OJ-3	8-1/2 x 12 x 20	20.5

## IMPEDANCE BRIDGE

TS-460A/U, -460B/U

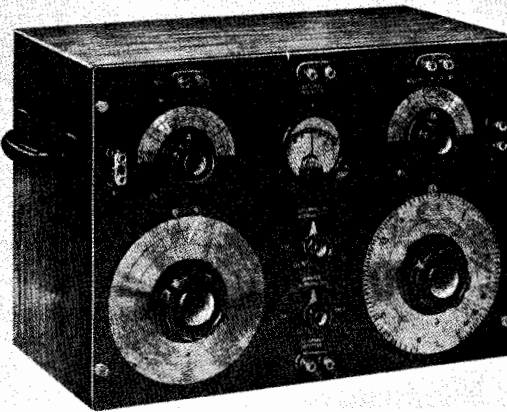

Impedance Bridge TS-460A/U, -460B/U

### FUNCTIONAL DESCRIPTION

Impedance Bridges TS-460A/U and TS-460B/U are four-arm bridges used to make direct measurements of resistance, capacitance, inductance, dissipation factor of capacitors and storage factor of inductors. The bridge has a built-in 1 kc signal source and a DC supply.

No field changes in effect at time of preparation (6 May 1958).

### RELATION TO OTHER EQUIPMENT

Models TS-460A/U and TS-460B/U are electrically identical. They are upright layout versions of Model TS-460/U (General Radio Model 650-A). Model TS-460A/U is enclosed in a hardwood cabinet. Model TS-460B/U is enclosed in a metal cabinet and its chassis and panel assembly are designed for optional relay-rack installation. They are superseded by Model TS-460C/U, which is similar in function, but has improved ranges and accuracies and is enclosed in a portable, dripproof metal case.

### ELECTRICAL AND MECHANICAL CHARACTERISTICS

POWER SUPPLY: 6 v DC, from four 1.5 v dry batteries Type BA-23.

#### RANGES

RESISTANCE: 1 milliohm to 1 megohm.  
CAPACITANCE: 1 uuf to 100 uf.  
INDUCTANCE: 1 uh to 100 L.  
DISSIPATION FACTOR: 0.002 to 1.0.  
STORAGE FACTOR: 0.02 to 1000

### ACCURACY

#### RESISTANCE:

1.2 OHMS TO 100 KILOHMS:  $\pm 1\%$ .

AT 1 MEGOHM:  $\pm 2\%$ .

0.2 TO 1.2 OHMS:  $\pm 1\%$  (when corrected for bridge distributed and lead resistance).

#### CAPACITANCE:

1000 UUF TO 10 UF:  $\pm 1\%$ .

AT 100 UF:  $\pm 2\%$ .

200 UUF TO 1000 UUF:  $\pm 1\%$  (when corrected for bridge and lead capacitance).

LESS THAN 200 UUF:  $\pm 2$  uuf.

#### INDUCTANCE:

100 UH to 1 H:  $\pm 2\%$ .

AT 10 H:  $\pm 5\%$ .

AT 100 H:  $\pm 10\%$ .

LESS THAN 100 UH:  $\pm 2$  uh (when corrected for bridge and lead inductance).

#### DISSIPATION FACTOR:

CAPACITORS GREATER THAN 500 UUF:  $\pm 20\%$  or 0.005 whichever is greater.

#### STORAGE FACTOR:

TO A VALUE OF 10:  $\pm 20\%$ .

LARGE VALUES:  $\pm 0.005$  for its reciprocal.

FREQUENCY RANGE: 60 cps to 10 kc, from external generator.

### MANUFACTURER'S OR CONTRACTOR'S DATA

Brown Engineering Co, Portland, Oregon.  
TASSA Order No. 11048-PHILA-47.

### TUBE AND/OR CRYSTAL COMPLEMENT

No Electron Tubes or Crystals used.

### REFERENCE DATA AND LITERATURE

TM11-2634: Technical Manual for Impedance Bridges TS-460/U, TS-460A/U and TS-460B/U.

TYPE CLASSIFICATION	Sub. Standard
DESIGN COGNIZANCE	TASSA
PROCUREMENT COGNIZANCE	
STOCK NO.	
R.D.B. IDENT. NO.	6.1.4

Test-Impedance and Standing Wave Ratio

TS-460A/U, 460B/U

IMPEDANCE BRIDGE

SHIPPING DATA

NUMBER OF BOXES	CONTENTS AND IDENTIFICATION	VOLUME (Cu.Ft.)	OVERALL DIMENSIONS (inches)	WEIGHT PACKED (lbs.)
1	Impedance Bridge TS-460A/U or TS-460B/U			41

EQUIPMENT SUPPLIED DATA

QUANTITY PER EQUIPT	NAME AND NOMENCLATURE	OVERALL DIMENSIONS (inches)	WEIGHT (lbs.)
	TS-460A/U		
1	Impedance Bridge TS-460A/U	10-3/4 X 12 X 17	23
2	Connector Plugs		
3	Battery Leads		0.03
2	Technical Manuals TM-11-2636		
	TS-460B/U		
1	Impedance Bridge TS-460B/U	9-1/2 X 13 X 22	23
2	Connector Plugs		
3	Battery Leads		0.03
1	Headset-49003		1.0
2	Technical Manual TM11-2634		

## IMPEDANCE BRIDGE

TS-460C/U

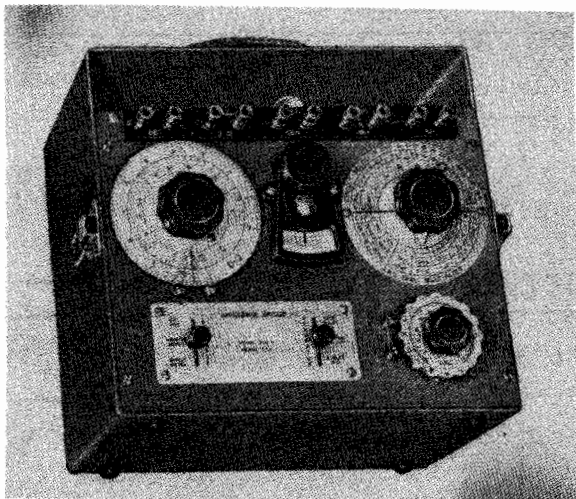

Impedance Bridge TS-460C/U

### FUNCTIONAL DESCRIPTION

Impedance Bridge TS-460C/U is a four-arm bridge used to make direct measurements of resistance, capacitance, inductance, dissipation factor of capacitors, and storage factor of inductors. The bridge has a built-in 1 kc signal source and a DC bridge source.

No field changes in effect at time of preparation (6 May 1958).

### RELATION TO OTHER EQUIPMENT

Model TS-460C/U supersedes Models TS-460A/U and TS-460B/U which have lesser ranges and accuracies. These impedance bridges are similar in design and function to Model TS-460/U (General Radio Model 650-A). Model TS-460A/U is enclosed in a hardwood cabinet. Model TS-460B/U is built in a metal cabinet, and its chassis and panel assembly is designed for optional relay rack installation. Model TS-460C/U is enclosed in a portable, drip-proof metal case.

### ELECTRICAL AND MECHANICAL CHARACTERISTICS

POWER SUPPLY: 6 v DC, from four 1.5 v dry batteries Type BA-30.

#### RANGES

RESISTANCE: 1 milliohm to 11 meg.  
CAPACITANCE: 1 uuf to 1100 uf.

INDUCTANCE: 1 uh to 1100 h.  
DISSIPATION FACTOR: 0.001 to 1.05.  
STORAGE FACTOR: 0.02 to 1000.

#### ACCURACY

##### RESISTANCE

0.1 RANGE:  $\pm(0.35\% \pm 1$  division on inner LRC dial).

1 MEG AND 11 MEG RANGE:  $\pm(0.2\% \pm 1$  division on inner LRC dial).

ALL OTHER RANGES:  $\pm(0.15\% \pm 1$  division on inner LRC dial).

##### CAPACITANCE

100 UUF TO 100 UF:  $\pm(0.5\% \pm 1$  division on inner LRC dial).

OVER 100 UF:  $\pm 2\%$ .

LESS THAN 100 UUF:  $\pm 2$  uuf (when corrected for bridge and lead capacitance).

##### INDUCTANCE

100 UH TO 10 H:  $\pm(1.0\% \pm 1$  division on inner LRC dial).

OVER 10 H:  $\pm 10\%$ .

LESS THAN 100 UH:  $\pm 2$  uh (when corrected for bridge and lead inductance).

##### DISSIPATION FACTOR

CAPACITORS GREATER THAN 0.1 UF:  $\pm(7\% + 0.0025)$ .

##### STORAGE FACTOR

UP TO 10 H:  $\pm(7\% + 0.0025)$ .

AT 100 H:  $\pm(7\% + 0.015)$ . In terms of its reciprocal.

AT 1000 H:  $\pm(7\% + 0.055)$ .

FREQUENCY RANGE: A few cycles to 10 kc, from external generator.

INTERNAL SIGNAL SOURCE: 1 kc,  $\pm 5\%$ .

### MANUFACTURER'S OR CONTRACTOR'S DATA

Brown Engineering Co, Portland, Oregon.

### TUBE AND/OR CRYSTAL COMPLEMENT

No Electron Tubes or Crystals used.

### REFERENCE DATA AND LITERATURE

TM11-2646: Technical Manual for Impedance Bridge TS-460C/U.

TYPE CLASSIFICATION	STANDARD
DESIGN COGNIZANCE	TASSA
PROCUREMENT COGNIZANCE	
STOCK NO.	
R.D.B. IDENT. NO.	6.1.4

UNCLASSIFIED

April 1958

Test-Impedance and Standing Wave Ratio

TS-460C/U

## IMPEDANCE BRIDGE

## SHIPPING DATA

NUMBER OF BOXES	CONTENTS AND IDENTIFICATION	VOLUME (Cu.Ft.)	OVERALL DIMENSIONS (inches)	WEIGHT PACKED (lbs.)
1	Impedance Bridge TS-460C/U and Accessories	1.13	11-1/2 X 12-1/2 X 13-1/2	20

## EQUIPMENT SUPPLIED DATA

QUANTITY PER EQUIPT	NAME AND NOMENCLATURE	OVERALL DIMENSIONS (inches)	WEIGHT (lbs.)
1	Impedance Bridge TS-460C/U	8-3/4 X 10-1/2 X 10-1/2	15
2	Test Leads	9-1/2 lg	
2	Technical Manuals TM11-2646		

UNCLASSIFIED

## SLOTTED LINE EQUIPMENT

TS-56/AP

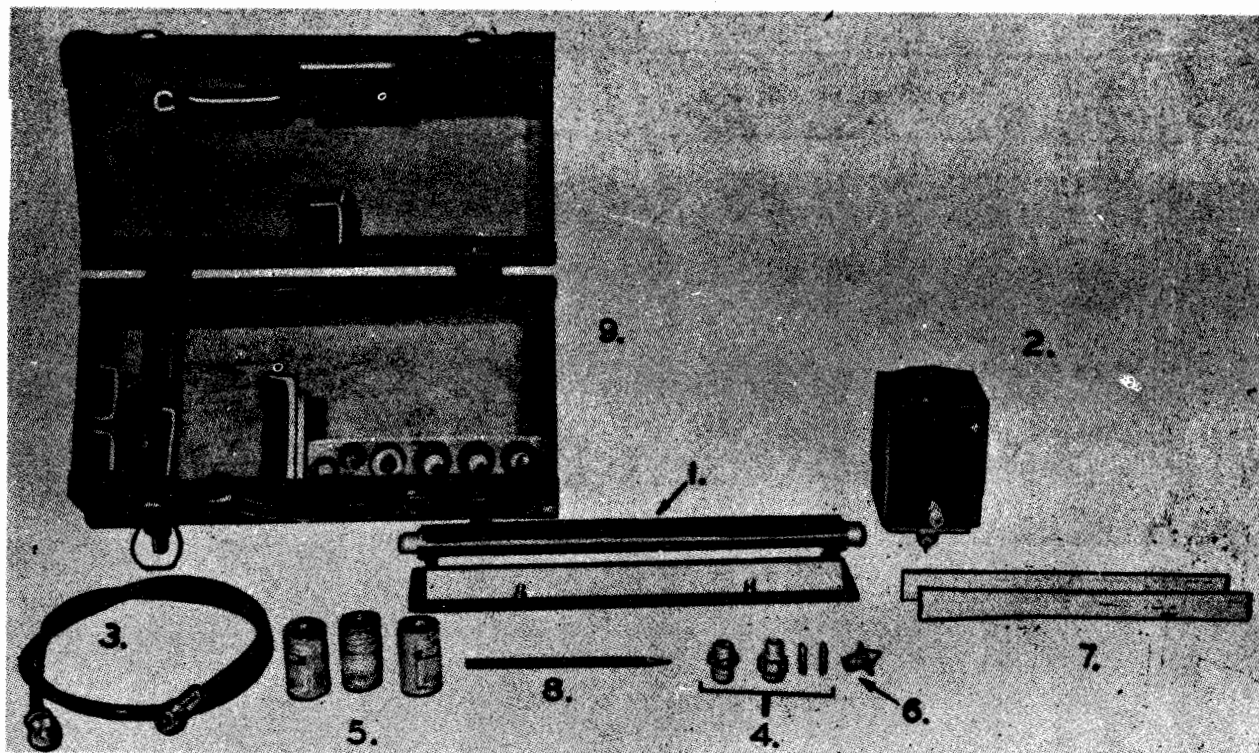

Slotted Line Equipment TS-56/AP

**FUNCTIONAL DESCRIPTION**

The TS-56/AP is a device primarily intended to facilitate the installation and maintenance of ASB airborne radar antennas. It can also be used for matching other antennas and in the measurement of characteristics of transmission lines, antennas and impedances.

No field changes in effect at time of preparation (25 October 1956).

**RELATION TO OTHER EQUIPMENT**

Equipment Required but not Supplied: (1) Oscillator.

**ELECTRICAL AND MECHANICAL CHARACTERISTICS**

FREQUENCY RANGE: 500 to 675 mc.  
IMPEDANCE: 51 ohms.

UNCLASSIFIED

**TUBE AND/OR CRYSTAL COMPLEMENT**

(1) 957  
Total Tubes: (1).

**REFERENCE DATA AND LITERATURE**

CO-AN08-35TS56-2: Technical Manual for Slotted Line Equipment TS-56/AP.

TYPE CLASSIFICATION  
DESIGN COGNIZANCE BUAER  
PROCUREMENT COGNIZANCE  
STOCK NO.  
R.D.B. IDENT. NO.

TS-56/AP

## SLOTTED LINE EQUIPMENT

## EQUIPMENT SUPPLIED DATA

QUANTITY PER EQUIPT	NAME AND NOMENCLATURE	OVERALL DIMENSIONS (inches)	WEIGHT (lbs.)
1	Slotted Line	2-1/2 X 3 X 16	6.5
1	Indicator Box	3-5/8 X 3-5/8 X 6	3.5
1	Cable	48 lg	1
2	Amphenol To Selector Adapter		
2	Spare Batteries		
1	Spare Tube 957		
2	Impedance Scale		
1	China Marking Pencil		
1	Wood Carrying Case	7 X 8-1/2 X 17-3/4	10



UNCLASSIFIED

Test-Impedance and Standing Wave Ratio

December 1956

## TEST SET

TS-56A/AP

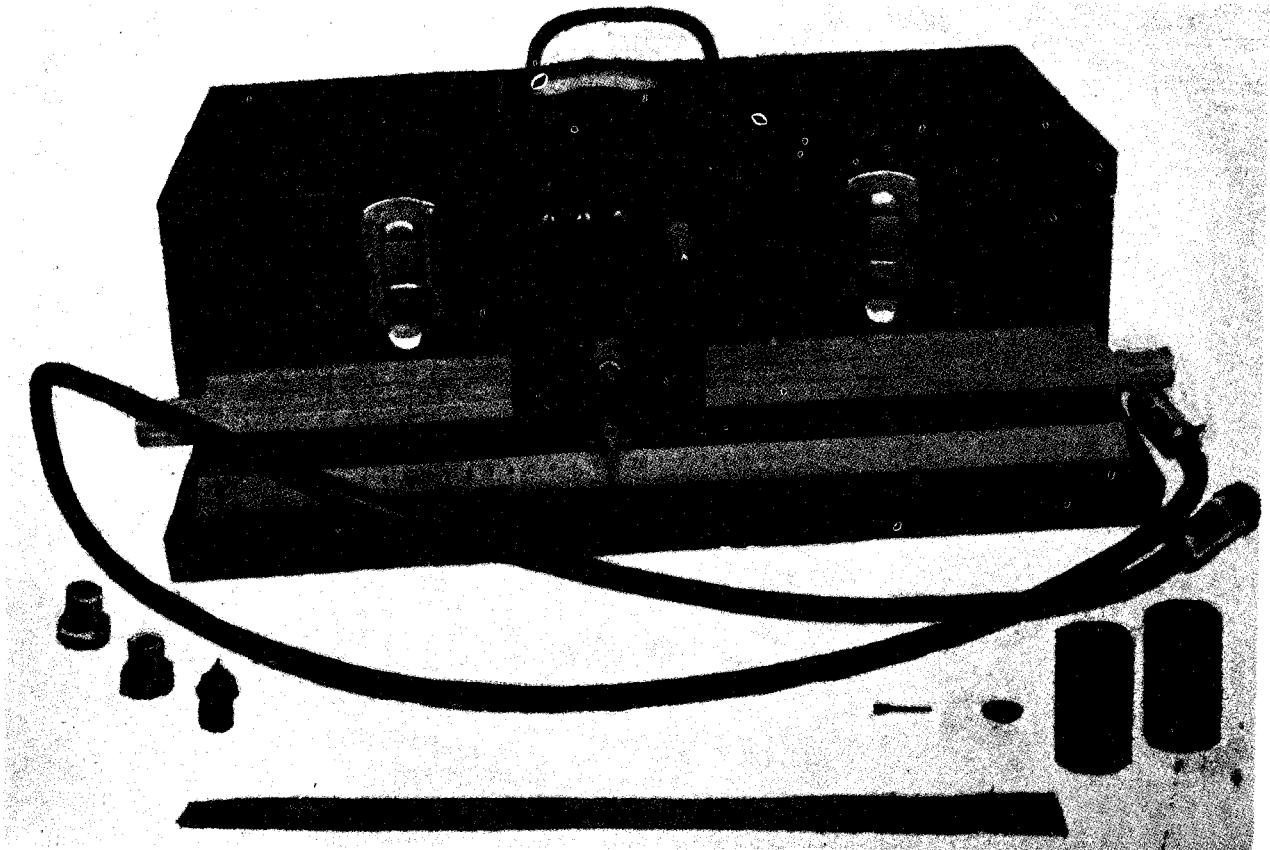

*Test Set TS-56A/AP*

### FUNCTIONAL DESCRIPTION

The TS-56A/AP is a slotted line device primarily intended to facilitate the installation and maintenance of ASB airborne radar antennas operating over a frequency range of 360 to 675 megacycles. It can also be used for matching other antennas and in the measurements of characteristics of transmission lines, antennas and impedance.

No field changes in effect at time of preparation (29 June 1956).

### RELATION TO OTHER EQUIPMENT

Equipment Required but not Supplied: (1) Oscillator.

### ELECTRICAL AND MECHANICAL CHARACTERISTICS

FREQUENCY RANGE: 360 to 675 mc.  
INPUT IMPEDANCE: 51 ohms.  
METEB RANGE: 0 to 100 ua.  
POWER REQUIREMENT: (1) battery (1.5 v flashlight).

### MANUFACTURER'S OR CONTRACTOR'S DATA

Maquire Industries, Greenwich, Conn  
Contract NXsa-39203, NXsa-37604.

### TUBE AND/OR CRYSTAL COMPLEMENT

(1) 957

Total Tubes: (1)

### REFERENCE DATA AND LITERATURE

CO-AN08-35TS56-3: Technical Manual for TS-56A/AP Equipment.

TYPE CLASSIFICATION
DESIGN COGNIZANCE RIAER
PROCUREMENT COGNIZANCE
STOCK NO.
R.D.B. IDENT. NO.

UNCLASSIFIED

4.6 TS-56A/AP: 1

TS-56A/AP

## TEST SET

December 1956

## EQUIPMENT SUPPLIED DATA

QUANTITY PER EQUIPT	NAME AND NOMENCLATURE	OVERALL DIMENSIONS (inches)	WEIGHT (lbs.)
1	Test Set TS-56A/AP		
1	Slotted Line	2-3/4 x 3-3/4 x 19-1/2	7.5
1	Indicator Box	3-1/2 x 3-1/2 x 6	3.5
1	Cable	48 lg	1.0
2	Amphenol to Selector Adapter		
2	Spare Batteries		
1	Spare Tube 957		
1	Spare Probe		
1	Impedance Scale		
1	Spare Insulating Spacer		
1	Carrying Case	5 x 8-1/2 x 19-3/4	13

UNCLASSIFIED

January 1958

Test-Impedance and Standing Wave Ratio  
**RADIO FREQUENCY BRIDGE**      **TS-582/U (60094)**

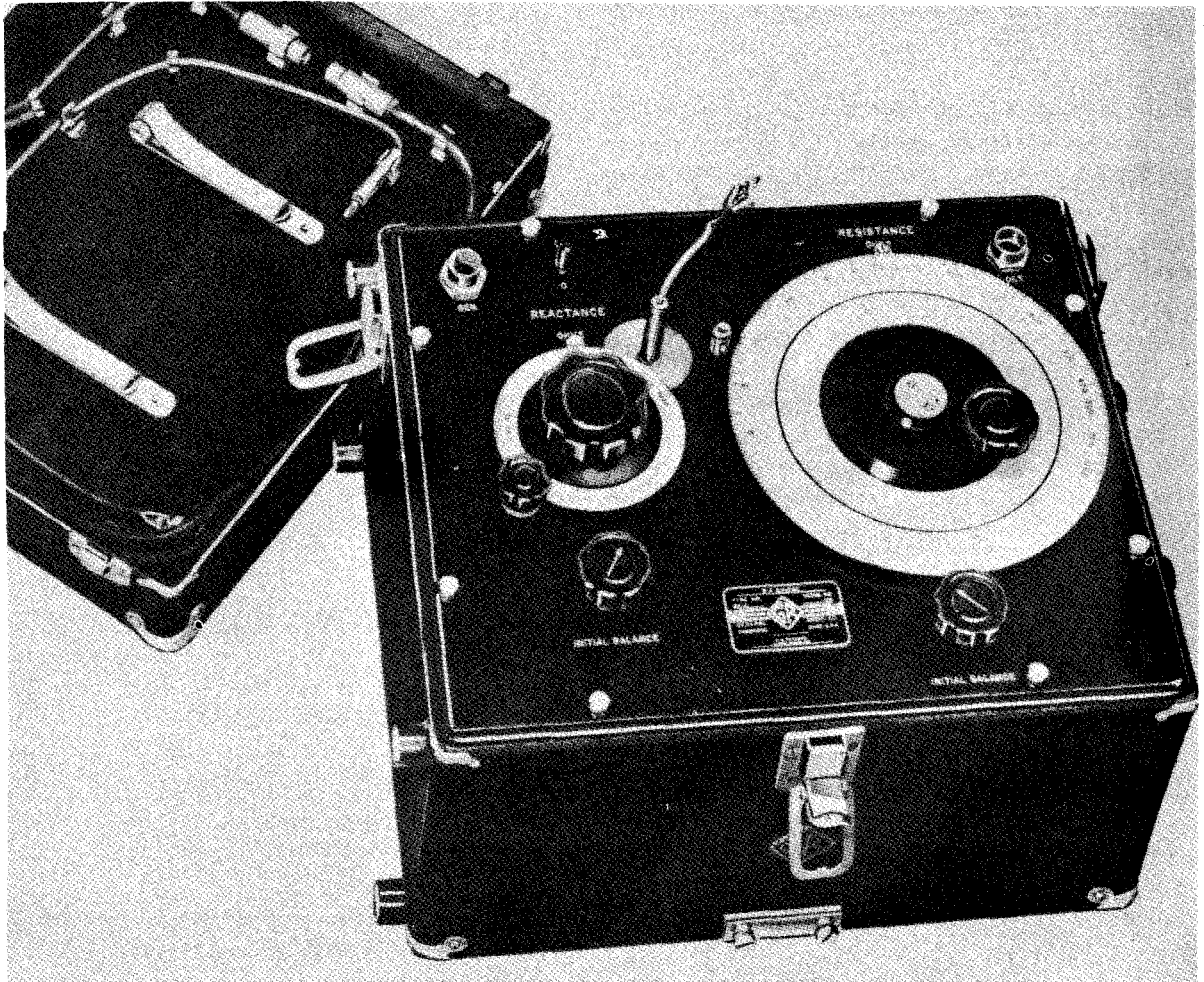

*Radio Frequency Bridge TS-582/U(60094)*

**FUNCTIONAL DESCRIPTION**

The TS-582/U is a null instrument for use in measuring impedance at frequencies from 400 kc to 60 mc. Measurements can be made with decreased accuracy at frequencies somewhat below and above these nominal frequency limits.

The bridge is used with a series-substitution method for measuring an unknown impedance in terms of its series resistant component and series reactance component. The resistance is read from a variable-condenser dial directly calibrated in resistance. The reactance is read from a variable-condenser dial directly calibrated in reactance at a

frequency of 1 mc. The resistance dial reading is independent of frequency. The reactance dial reading increases linearly with frequency. For frequencies other than 1 mc the reactance dial reading must therefore be divided by the operating frequency in megacycles. The resistance dial reads from 0 to 1000 ohms and the reactance dial reads from 0 to 5000 ohms at 1 mc.

No field changes in effect at time of preparation (23 September 1957).

**RELATION TO OTHER EQUIPMENT**

Identical to the Navy Type 60094 and to General Radio Type 916-A.

UNCLASSIFIED

Test-Impedance and Standing Wave Ratio

TS-582/U (60094)

**RADIO FREQUENCY BRIDGE**

**ELECTRICAL AND MECHANICAL CHARACTERISTICS**

FREQUENCY RANGE: 400 kc to 60 mc.  
 RESISTANCE COMPONENT RANGE: 0 to 1000 ohms  
 with an accuracy of  $\pm 1\% \pm 0.1$  ohms.  
 REACTANCE COMPONENT RANGE: 0 to 5000 ohms  
 at 1 mc with an accuracy of  $\pm 2\% \pm 1$  ohm.  
 INPUT SIGNAL REQUIRED: 1 to 10 v.  
 DETECTOR SENSITIVITY REQUIRED: 1 to 10 uv.  
 PRESENTATION AND CONTROLS:

The main unit of this equipment has a large vernier resistance dial, and a smaller vernier reactance dial with initial balance knobs for each component. It has a toggle switch to select L or C components to be measured and coaxial receptacles (GR TYPE 774-G) for the input signal and the detector.

FITTINGS AND ACCESSORIES: To accommodate the frequency range two input transformers are used, one for the range 400 kc to 3 mc and the other, 3 mc and 60 mc. Two leads are supplied for connection to the unknown impedance and two coaxial cables for connecting the bridge to the signal generator and detector. The signal generator and detector are not part of the equipment. The cables are fitted on each end with General Radio type 774-M coaxial plugs.

CONSTRUCTION: The equipment is enclosed in a metal case with black wrinkle finish fitted with a snap-down latch cover. Cables, accessories and instructions are stored in the cover.

**MANUFACTURER'S OR CONTRACTOR'S DATA**

General Radio Co., Cambridge 39, Massachusetts  
 Contract NXs-62333.

**TUBE AND/OR CRYSTAL COMPLEMENT**

No Electron Tubes.

**REFERENCE DATA AND LITERATURE**

TM 11-2633, Technical Manual for Radio Frequency Bridge Type 916-A.

TYPE CLASSIFICATION  
 DESIGN COGNIZANCE TASSA  
 PROCUREMENT COGNIZANCE  
 STOCK NO.

**EQUIPMENT SUPPLIED DATA**

QUANTITY PER EQUIPT	NAME AND NOMENCLATURE	OVERALL DIMENSIONS (inches)	WEIGHT (lbs.)
1	R.F. Bridge Unit	11-1/8 X 13-1/2 X 17	
1	Test Lead	6-1/2 lg	
1	Test Lead	36 lg	
2	Coaxial Cable		
2	R.F. Transformers		
2	Technical Manual TM11-2633		

UNCLASSIFIED

Test-Impedance and Standing Wave Ratio

March 1957

# STANDING WAVE RATIO INDICATOR

XSL

## FUNCTIONAL DESCRIPTION

The Model XSL is a meter indicating general purpose type Standing Wave Ratio Indicator for use with transmission lines over the frequency range from 170 to 180 megacycles.

No field changes in effect at time of preparation (8 October 1956).

## ELECTRICAL AND MECHANICAL CHARACTERISTICS

FREQUENCY RANGE: 170 to 180 mc.

METER RANGE: 0 to 100 ma.

POWER SOURCE: 115 v, 60 cps, single ph.

## TUBE AND/OR CRYSTAL COMPLEMENT

No Electron Tubes.

## REFERENCE DATA AND LITERATURE

Federal Item Identification Card.

TYPE CLASSIFICATION	
DESIGN COGNIZANCE	BUSHIPS
PROCUREMENT COGNIZANCE	
STOCK NO.	
R.D.B. IDENT. NO.	

## EQUIPMENT SUPPLIED DATA

QUANTITY PER EQUIPT	NAME AND NOMENCLATURE	OVERALL DIMENSIONS (inches)	WEIGHT (lbs.)
1	Standing Wave Ratio Indicator Model XSL	2-3/8 x 4-3/4 x 5-5/8	

UNCLASSIFIED

4.6 XSL: 1

---

3 April 1962	6625-643-3034	OHMMETER ZM-1/U
Cog Service: USN	FSN: 6625-643-3510 W/S	Functional Class: 6.1.1
USA	USN	USAF

---

TYPE CLASS: Std Std

MANUFACTURER'S NAME/CODE NUMBER: Radio Frequency Laboratories Inc., (49673).

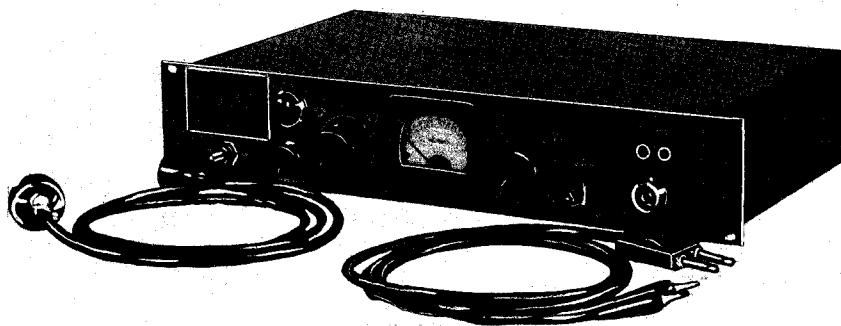

*Ohmmeter ZM-1/U*

**FUNCTIONAL DESCRIPTION:**

Ohmmeter ZM-1/U measures resistance between 0.5 and 100 megohms and is specifically designed to measure the leakage resistance of balanced and unbalanced communication lines. It is used in rf and af distribution systems to measure the leakage resistance of wire pairs and coaxial cables.

No field changes in effect at time of preparation (1 February 1962).

**TECHNICAL CHARACTERISTICS:**

POWER REQUIREMENTS: 95 to 130 v, 50 to 60 cyc, single ph.  
METER: To 45 ua for full scale deflection.  
RESISTANCE RANGE: 0 to 200 meg.  
MOUNTING DATA: Designed to mount on a std 19 in. relay rack.

---

**ZM-1/U OHMMETER**

---

**RELATION TO OTHER EQUIPMENT:** None.

**EQUIPMENT REQUIRED BUT NOT SUPPLIED:** None.

---

**MAJOR COMPONENTS**

---

QTY	ITEM	STOCK NUMBERS	DIMENSIONS (INCHES)	WEIGHT (LBS)
1	Ohmmeter ZM-1/U includes:		4 x 19 x 11	13
1	Cable Ass'y			
1	Cable Ass'y			
1	Set Equipment Spares		6 x 12 x 12	22

---

---

**REFERENCE DATA AND LITERATURE:**

NAVSHIPS 900, 948: Technical Manual for Ohmmeter ZM-1/U.

---

---

**TUBE, CRYSTAL AND/OR SEMI-CONDUCTOR DATA:**

TUBES: (2) OC3/VR105 (2) OD3/VR150 (1) 6X5GT/G

CRYSTALS: None used.

SEMI-CONDUCTORS: None used.

---

---

**SHIPPING DATA**

---

PKGS	VOLUME (CU FT)	WEIGHT (LBS)
1	8.25	87

---

---

**PROCUREMENT DATA**

---

PROCURING SERVICE: USN

DESIGN COG: USN, BuShips

SPEC &/OR DWG:

---

CONTRACTOR	LOCATION	CONTRACT OR ORDER NO.	APPROX. UNIT COST
Radio Frequency Laboratories Inc.	Boonton, N. J.	N0bsr-30130, 20 June 1946	\$300.00

---

28 May 1962

OHMMETER ZM-1A/U

Cog Service: USN FSN: 6625-643-2529

Functional Class: 6.1.1

USA

USN

USAF

TYPE CLASS:

Std

MANUFACTURER'S NAME/CODE NUMBER: Electronic Engineering and Service Co. Inc., (88780).

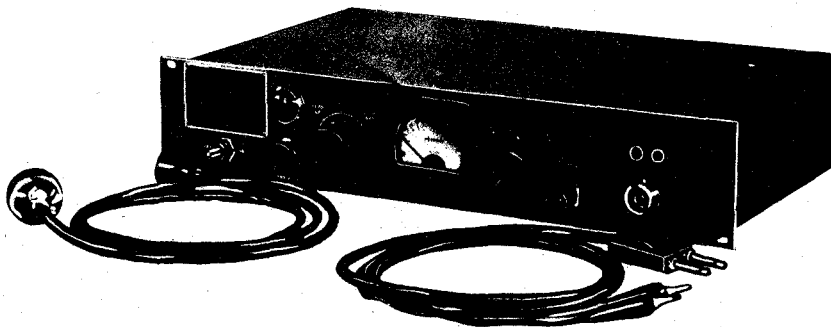

*Ohmmeter ZM-1A/U*

**FUNCTIONAL DESCRIPTION:**

Ohmmeter ZM-1A/U measures resistance between 0.5 and 100 megohms and is specifically designed to measure the leakage resistance of balanced and unbalanced communication lines. It is used in rf and af distribution systems to measure the leakage resistance of wire pairs and coaxial cables.

No field changes in effect at time of preparation (1 February 1962).

**TECHNICAL CHARACTERISTICS:**

POWER REQUIREMENTS: 95 to 130 v, 50 to 60 cyc, single ph.

METER: To 45 ua for full scale deflection.

RESISTANCE RANGE: 0 to 200 meg.

MOUNTING DATA: Designed to mount on a standard 19 in. relay rack.

RELATION TO OTHER EQUIPMENT: None.

4.6 ZM-1A/U: 1



---

**ZM-1A/U OHMMETER**

---

**EQUIPMENT REQUIRED BUT NOT SUPPLIED:** None.

---

**MAJOR COMPONENTS**

---

QTY	ITEM	STOCK NUMBERS	DIMENSIONS (INCHES)	WEIGHT (LBS)
1	Ohmmeter ZM-1A/U includes:		4 x 11 x 19	13
1	Cable Assy, Power, Electrical CX-2640/U		84 lg	
1	Cable Assy, Special Purpose, Electrical CX-2641/U		60 lg	

---

---

**REFERENCE DATA AND LITERATURE:**

---

NAVSHIPS 91980: Technical Manual for Ohmmeter ZM-1A/U.

---

---

**TUBE, CRYSTAL AND/OR SEMI-CONDUCTOR DATA:**

---

TUBES: (2) 0C3/VR105 (2) 0D3/VR150 (1) 6X5GT/G

CRYSTALS: None used.

SEMI-CONDUCTORS: None used.

---

---

**SHIPPING DATA**

---

PKGS	VOLUME (CU FT)	WEIGHT (LBS)
1	1.31	30

---

---

**PROCUREMENT DATA**

---

PROCURING SERVICE: USN  
SPEC &/OR DWG: MIL-0-17049(SHIPS)

DESIGN COG: USN, BuShips

---

CONTRACTOR	LOCATION	CONTRACT OR ORDER NO.	APPROX. UNIT COST
Electronic Engineering and Service Co. Inc. Part no. 1200	Falls Church, Va.	N0bsr-57463, 23 June 1952	\$215.22

---

3 April 1962

Cog Service: USN FSN: 6625-838-5930

OHMMETER ZM-1B/U

Functional Class: 6.1.1

USA

USN

USAF

TYPE CLASS:

Std

MANUFACTURER'S NAME/CODE NUMBER: Jetronic Industries Inc., (91820).

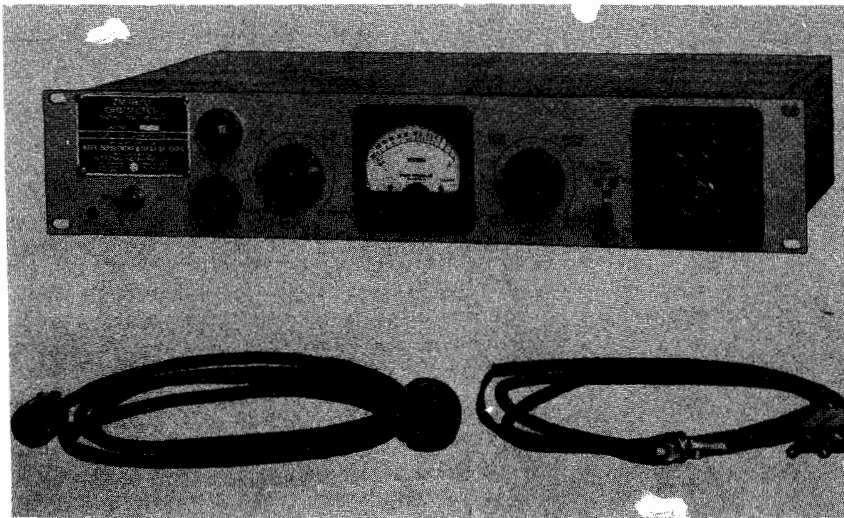

*Ohmmeter ZM-1B/U*

**FUNCTIONAL DESCRIPTION:**

Ohmmeter ZM-1B/U measures resistance between 0.5 and 100 megohms and is designed specifically to measure the leakage resistance of balanced and unbalanced communication lines. It is used in RF and AF distribution systems to measure the leakage resistance of wire pairs and coaxial cables.

No field changes in effect at time of preparation (1 February 1962).

**TECHNICAL CHARACTERISTICS:**

POWER REQUIREMENTS: 95 to 130 v, 50 to 60 cyc, single ph.

METER: To 45 ua for full scale deflection.

RESISTANCE RANGE: 0 to 200 meg.

MOUNTING DATA: Designed to mount on a std 19 in. relay rack.

---

**ZM-18/U OHMMETER**

---

**RELATION TO OTHER EQUIPMENT:** None.

**EQUIPMENT REQUIRED BUT NOT SUPPLIED:** None.

---

**MAJOR COMPONENTS**

---

QTY	ITEM	STOCK NUMBERS	DIMENSIONS (INCHES)	WEIGHT (LBS)
1	Ohmmeter ZM-18/U includes:		3-15/32 x 10-1/2 x 19	12.5
1	Cable Ass'y, Power, Electrical CX-2849/U		84	
1	Test Lead CX-2848/U		84	

---

**REFERENCE DATA AND LITERATURE:**

NAVSHIPS 92086: Technical Manual for Ohmmeter ZM-18/U.

---

**TUBE, CRYSTAL AND/OR SEMI-CONDUCTOR DATA:**

TUBES: (2) 0C3/VR105 (2) 0D3/VR150 (1) 6X5GT/G

CRYSTALS: None used.

SEMI-CONDUCTORS: None used.

---

**SHIPPING DATA**

---

PKGS	VOLUME (CU FT)	WEIGHT (LBS)
1	1.3	18

---

**PROCUREMENT DATA**

---

PROCURING SERVICE: USN

DESIGN COG: USN, BuShips

SPEC &/OR DWG: MIL-0-16485A (SHIPS), Amend 1

---

CONTRACTOR	LOCATION	CONTRACT OR ORDER NO.	APPROX. UNIT COST
Jetronic Industries Inc.	Philadelphia, Pa.	N0bsr-63271	\$129.84
		N0bsr-75405	\$280.00

---

# CAPACITANCE-INDUCTANCE-RESISTANCE BRIDGE

ZM-11/U

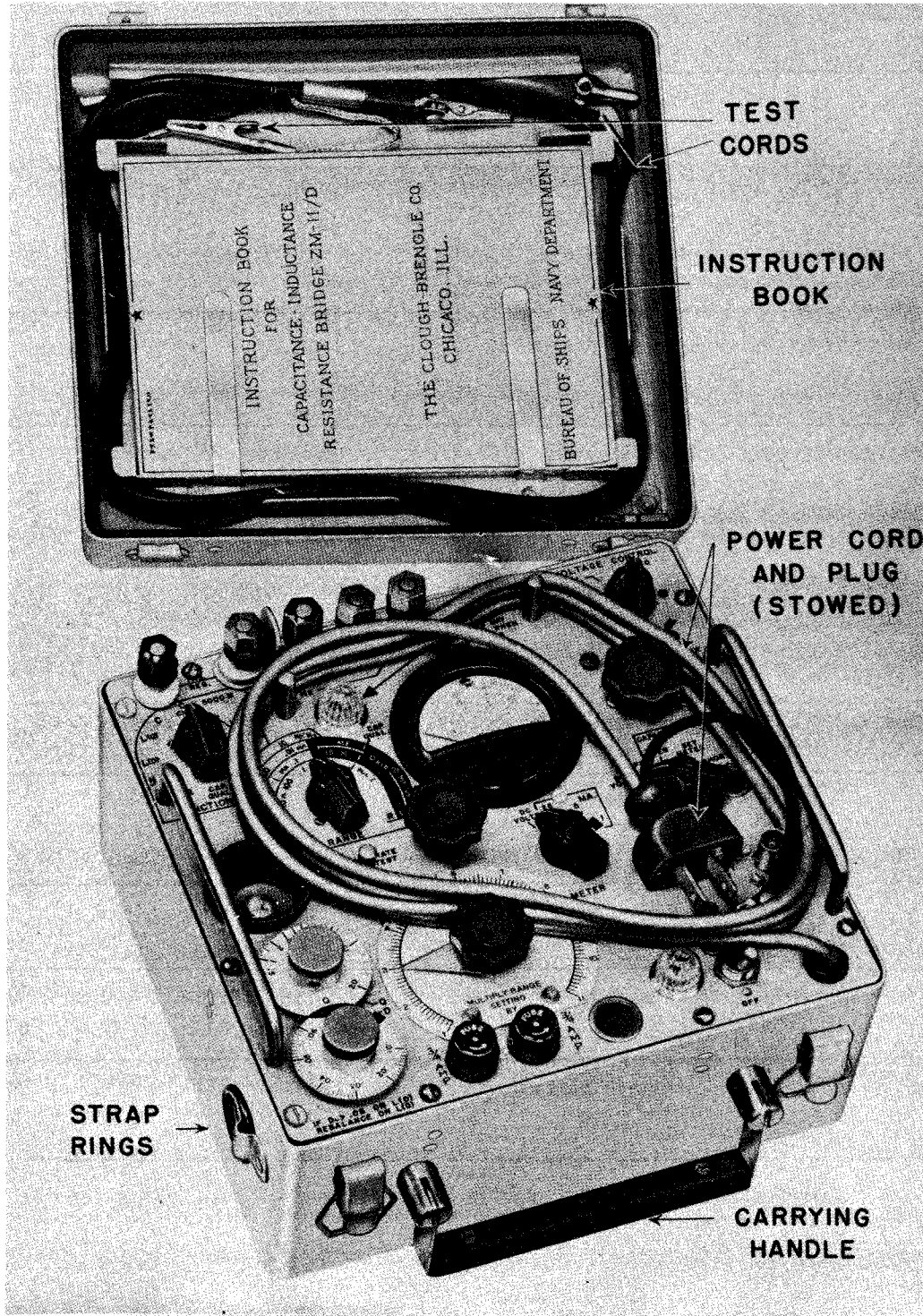

Capacitance-Inductance-Resistance Bridge ZM-11/U

April 1958

Test-Impedance and Standing Wave Ratio

**ZM-11/U****CAPACITANCE-INDUCTANCE-RESISTANCE  
BRIDGE****FUNCTIONAL DESCRIPTION**

The ZM-11/U is a portable instrument designed to examine such electronic parts as resistors, capacitors, coils, chokes, and transformers for condition and suitability for installation. It is self-contained except for a source of line power and embodies its own source of 1000 cycle bridge current together with a sensitive bridge balance indicator; and adjustable source of direct current for electrolytic capacitor and insulation resistance testing; and a meter with suitable ranges for leakage current tests on electrolytic capacitors.

No field changes in effect at time of preparation (18 April 1958).

**RELATION TO OTHER EQUIPMENT**

The ZM-11/U supersedes Capacitance and Resistance Bridge NT-60007. The ZM-11/U has a greater range, includes inductance measurement, and is more compact in design.

**ELECTRICAL AND MECHANICAL CHARACTERISTICS****RANGE DATA**

CAPACITANCE: 10 uuf to 10 uf, 1 uf to 100 uf, 10 uf to 1100 uf.

INDUCTANCE: 0.1 mh to 1 hy, 1 to 10 hy, 10 to 110 hy.

RESISTANCE: 1 ohm to 11 meg.

INSULATION RESISTANCE(DC): 200 to 500 meg, 5000 to 10000 meg.

TRANSFORMER TURN RATIO: 0.01 to 110.

CAPACITOR LEAKAGE CURRENT(DC): 0 to 1, 5, 25 ma.

D DISSIPATION FACTOR: 0 to 0.06 (10 uuf to 0.1 uf), 0 to 0.6 (0.1 uf to 1100 uf).

Q STORAGE FACTOR: 0.5 to 20.

ELECTROLYTIC CAPACITOR VOLTAGE(DC): 0 to 500 v.

**ACCURACIES (NORMAL CONDITIONS)****CAPACITANCE**

10 UUF TO 10 UF: 2% +1 scale div.

1 UF TO 100 UF: 3% +1 scale div.

10 UF TO 1100 UF: 5% +1 scale div.

**INDUCTANCE**

0.1 MH TO 1 HY: 2% +1 scale div.

1 HY TO 10 HY: 5% +1 scale div.

10 HY TO 110 HY: 10% +1 scale div.

RESISTANCE: 2% +1 scale div.

**INSULATION RESISTANCE (DC)**

200 TO 500 MEG: 3% +100 meg.

5000 TO 10000 MEG: 3% +200 meg.

TRANSFORMER TURN RATIO: 2% +1 scale div.

CAPACITOR LEAKAGE CURRENT (DC): 3% of full scale.

D DISSIPATION FACTOR: 20% +0.02 in. D.

Q STORAGE FACTOR: 20%.

ELECTROLYTIC CAPACITOR VOLTAGE (DC): 5% of full scale.

POWER REQUIREMENTS: 105 to 125 v, 50 to 1000 cps, 29 W.

**MANUFACTURER'S OR CONTRACTOR'S DATA**

The Clough-Brengle Company, Chicago, Ill.  
Contract NObsr-43157, dated 9 December 1948.

Contract NObsr-49270, dated 26 June 1950.

Contract NObsr-52462, dated 26 May 1951.

Contract NObsr-59239, dated 25 November 1951.

Contract NObsr-63220, dated 20 February 1953.

Approximate Cost: \$230.00 with equipment spares.

**TUBE AND/OR CRYSTAL COMPLEMENT**

(1) 5726/6AL5W

(1) 6AG5

(2) 6AV6

(1) 6E5

(1) 6J6WA

(1) 6X4WA

(1) 6005/6AQ5W

Total Tubes: (8)

No Crystals used.

**REFERENCE DATA AND LITERATURE**

NAVSHIPS 91704: Technical Manual for Bridge Capacitance-Inductance-Resistance ZM-11/U.

**TYPE CLASSIFICATION**

DESIGN COGNIZANCE BUSHIPS

PROCUREMENT COGNIZANCE MIL-B-15421A(SHIPS)

STOCK NO.

R.D. NO. 6.1.4.5

UNCLASSIFIED

April 1958

Test-Impedance and Standing Wave Ratio

# CAPACITANCE-INDUCTANCE-RESISTANCE BRIDGE

ZM-11/U

## EQUIPMENT SUPPLIED DATA

QUANTITY PER EQUIPT	NAME AND NOMENCLATURE	OVERALL DIMENSIONS (inches)	WEIGHT (lbs.)
1	Capacitance-Inductance-Resistance Bridge ZM-11/U including: (1) Cable Assembly (1) Test Lead, Red (1) Test Lead, Black	5-11/16* X 8-27/32 X 9-5/8 1/2 X 1/2 X 48 1/2 X 1/2 X 36 1/2 X 1/2 X 36	14*
2	Technical Manual NAVSHIPS 91704	1/2 X 5-3/4 X 7	
1	Set of Equipment Spares		

NOTE: \*-Equipment serial numbers 971 thru 1366 height is 6-3/8 in., weight is 15 lbs.

UNCLASSIFIED

4.6 ZM-11/U: 3

26 February 1963  
Cog Service: USN

FSN: F6625-646-6751

CAPACITANCE-INDUCTANCE-RESISTANCE BRIDGE ZM-11A/U  
Functional Class: 6.1.4.5

USA

USN

USAF

TYPE CLASS:

Used by

MANUFACTURER'S NAME/CODE NUMBER: Crescent Communications Corp., (00346).

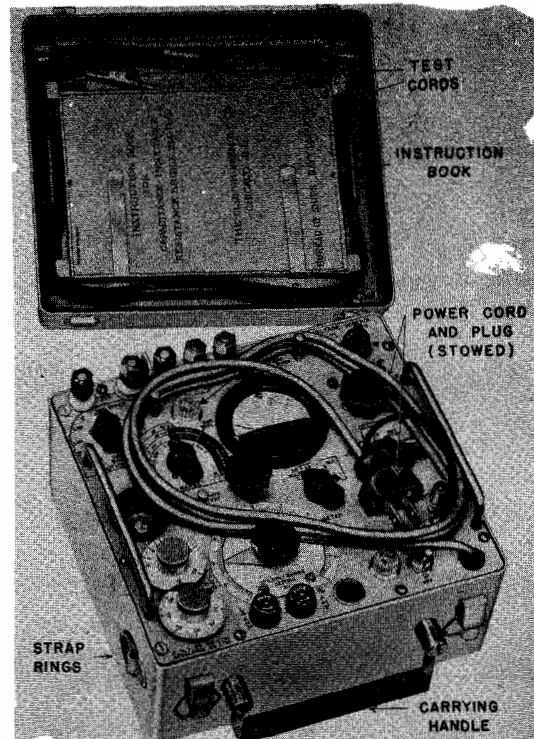

*Capacitance-Inductance-Resistance Bridge ZM-11A/U*

**FUNCTIONAL DESCRIPTION:**

Capacitance-Inductance-Resistance Bridge ZM-11A/U is a portable instrument used in measuring and checking capacitors, resistors, inductors, and transformers to determine their value and condition.

No field changes in effect at time of preparation (8 December 1962).

**TECHNICAL CHARACTERISTICS:**

**RANGE DATA:**

CAPACITANCE: 10 uuf to 10 uf, 1 uf to 100 uf, 10 uf to 1100 uf.

INDUCTANCE: 0.1 mh to 1 hy, 1 to 10 hy, 10 to 110 hy.

RESISTANCE: 1 ohm to 11 meg.

INSULATION RESISTANCE (DC): 200 to 500 meg, 5000 to 10000 meg.

TRANSFORMER TURN RATIO: 0.01 to 110.

---

**ZM-11A/U CAPACITANCE-INDUCTANCE-RESISTANCE BRIDGE**

---

CAPACITOR LEAKAGE CURRENT (DC): 0 to 1, 5, 25 ma.

D DISSIPATION FACTOR: 0 to 0.06 (10 uuf to 0.1 uf), 0 to 0.6 (0.1 uf to 1100 uf).

Q STORAGE FACTOR: 0.5 to 20.

ELECTROLYTIC CAPACITOR VOLTAGE (DC): 0 to 500 v.

**ACCURACIES (NORMAL CONDITIONS)****CAPACITANCE**

10 UUF TO 10 UF: 2% P1 scale div.

1 UF TO 100 UF: 3% P1 scale div.

10 UF TO 1100 UF: 5% P1 scale div.

**INDUCTANCE**

0.1 MH TO 1 HY: 2% P1 scale div.

1 HY to 10 HY: 5% P1 scale div.

10 HY to 110 HY: 10% P1 scale div.

RESISTANCE: 2% P1 scale div.

**INSULATION RESISTANCE (DC)**

200 TO 500 MEG: 3% P100 meg.

5000 TO 10000 MEG: 3% P200 meg.

TRANSFORMER TURN RATIO: 2% P1 scale div.

CAPACITOR LEAKAGE CURRENT (DC): 3% of full scale.

D DISSIPATION FACTOR: 20% P0.02 in. D.

Q STORAGE FACTOR: 20%.

ELECTROLYTIC CAPACITOR VOLTAGE (DC): 5% of full scale.

POWER REQUIREMENTS: 105 to 125 v, 50 to 1000 cps, 29 W.

**RELATION TO OTHER EQUIPMENT:** None.

**EQUIPMENT REQUIRED BUT NOT SUPPLIED:** None.

---

**MAJOR COMPONENTS**

---

QTY	ITEM	STOCK NUMBERS	DIMENSIONS (INCHES)	WEIGHT (LBS)
1	Capacitance-Inductance-Resistance Bridge ZM-11A/U		6-3/8 x 9-3/4 x 10-1/8	15
1	Cable Assembly, RF		1/2 x 1/2 x 48	
1	Test Lead, Red			
1	Test Lead, Black			
2	Technical Manual NAVSHIPS 91704			

---

**REFERENCE DATA AND LITERATURE:**

NAVSHIPS 91704: Technical Manual for Bridge Capacitance-Inductance-Resistance ZM-11/U and ZM-11A/U.

---

**TUBE, CRYSTAL AND/OR SEMI-CONDUCTOR DATA:**

TUBES: (1) 6AG5 (2) 6AV6 (1) 6E5 (1) 6J6 (1) 6X4W (1) 6005/6AQ5 (1) 5726/6AL5W

CRYSTALS: None used.



---

**CAPACITANCE-INDUCTANCE-RESISTANCE BRIDGE ZM-11A/U**

---

SEMI-CONDUCTORS: None used.

---

**SHIPPING DATA**

---

PKGS	VOLUME (CU FT)	WEIGHT (LBS)
1	0.89	

---

**PROCUREMENT DATA**

---

PROCURING SERVICE: USN

DESIGN COG: USN, BuShips

SPEC &amp;/OR DWG: MIL-B-15421B(SHIPS) and Amend 1

CONTRACTOR	LOCATION	CONTRACT OR ORDER NO.	APPROX. UNIT COST
Crescent Communications Corporation Dwg no. 210-2-067	New London, Conn.	N0bsr-71729, 20 March 1957	\$256.00
		N0bsr-75078, 12 December 1957	\$250.00
		N0bsr-75413, 26 June 1958	\$265.00
		N0bsr-81237	\$239.00
		N0bsr-81597	\$242.82

April 1958

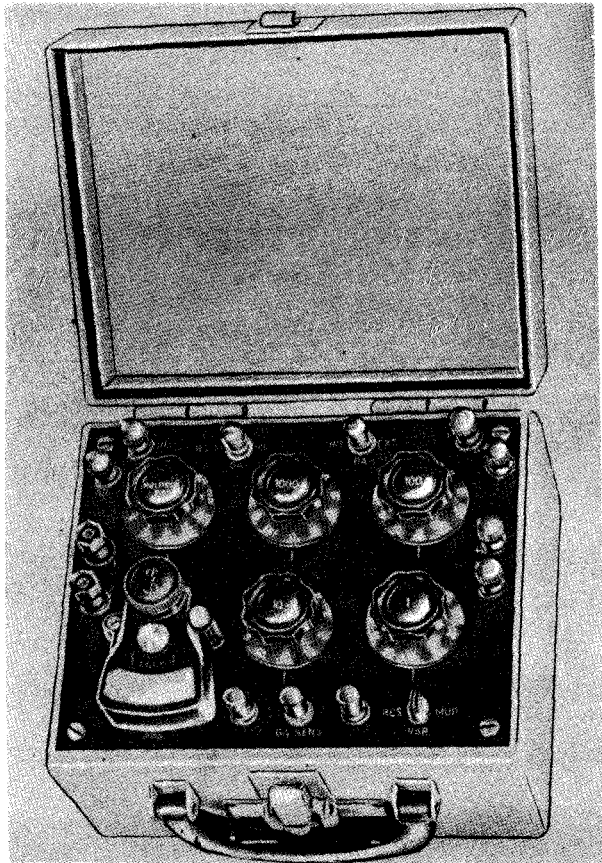
**RESISTANCE BRIDGE****ZM-4/U, -4B/U**

Resistance Bridge ZM-4/U, -4B/U

an aluminum case.

No field changes in effect at time of preparation (6 January 1958).

**ELECTRICAL AND MECHANICAL CHARACTERISTICS**

RANGE: 1 ohm to 10 meg.

ACCURACY:  $\pm 0.15\%$   $\pm 0.01$  ohm.

PRESENTATION AND CONTROLS: Calibrated dials are used to select individual resistors and decade multiplier resistors. A null is indicated on the self-contained galvanometer. Binding posts permit use of an external null indicator and external batteries, provided the internal item is disconnected.

POWER SOURCE REQUIRED: 4.5 v DC internal; 200 v DC max external.

**MANUFACTURER'S OR CONTRACTOR'S DATA**

Shallcross Mfg, Co, Collingdale, Pa.  
Contract NObsr-52316.

**TUBE AND/OR CRYSTAL COMPLEMENT**

No Electron Tubes or Crystals.

**REFERENCE DATA AND LITERATURE**

NAVSHIPS 91073(A): Technical Manual for Resistance Bridge ZM-4/U.

NAVSHIPS 91750: Technical Manual for Resistance Bridge ZM-4B/U.

**FUNCTIONAL DESCRIPTION**

The ZM-4/U and ZM-4B/U are portable equipments designed to measure resistances in locating faults which occur in conductors used for communications systems, and on those used for power transmission. It can also be used to measure any fixed resistors having values between approximately 0.1 ohm and 10 megohms.

It is self-contained in that it has a galvanometer mounted on the top plate, and three dry cells within the compartment case to supply the required power. Provisions are made to use a separately mounted galvanometer and external dry cells when the corresponding internal items are disconnected.

The ZM-4B/U is similar to ZM-4/U except that it has improved and relocated panel controls and connectors, and is enclosed in

TYPE CLASSIFICATION  
DESIGN COGNIZANCE BUSHIPS  
PROCUREMENT COGNIZANCE  
STOCK NO.  
R.D.B. IDENT. NO.

Test-Impedance and Standing Wave Ratio

ZM-4/U,-4B/U

## RESISTANCE BRIDGE

April 1958

## SHIPPING DATA

NUMBER OF BOXES	CONTENTS AND IDENTIFICATION	VOLUME (Cu.Ft.)	OVERALL DIMENSIONS (inches)	WEIGHT PACKED (lbs.)
1	Resistance Bridge ZM-4/U or ZM-4B/U	1.7	10 x 16 x 18	44

## EQUIPMENT SUPPLIED DATA

QUANTITY PER EQUIPT	NAME AND NOMENCLATURE	OVERALL DIMENSIONS (inches)	WEIGHT (lbs.)
1	Resistance Bridge ZM-4/U or ZM-4B/U	5-5/8 x 7-1/2 x 9	8
2	Technical Manuals NAVSHIPS-91073A or NAVSHIPS 91750		
3	Flashlight Cells BA-30	1-5/16 dia x 2-5/16	1

April 1958

Test-Impedance and Standing Wave Ratio

# IMPEDANCE BRIDGE

ZM-6/U

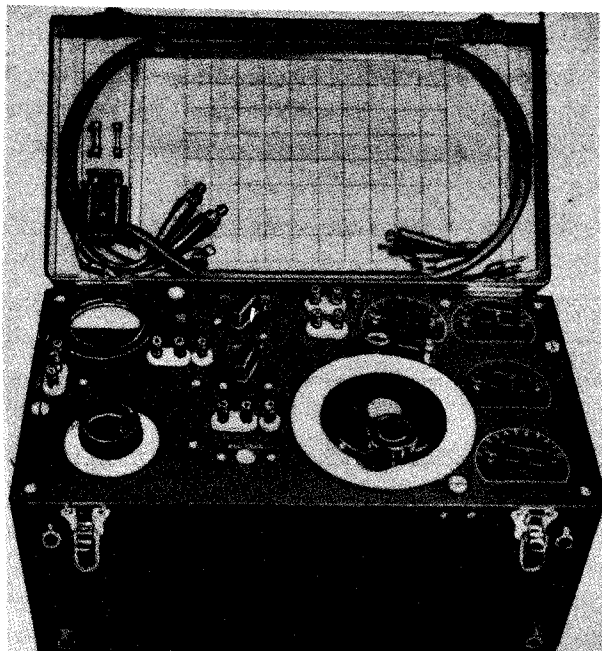

*Impedance Bridge ZM-6/U*

## ELECTRICAL AND MECHANICAL CHARACTERISTICS

FREQUENCY RANGE: 200 to 550 kc.  
 REACTANCE: 0 to 300 ohms.  
 RESISTANCE: 0 to 211 ohms.  
 CAPACITY: 0 to 900 uuf.  
 INDUCTANCE: Dependent of frequency range of RF energy source.  
 METER: 0 to 115 ma, thermo-galvanometer type, 100 scale divisions.

## MANUFACTURER'S OR CONTRACTOR'S DATA

The Pioneer Electric and Research Corp,  
 Forest Park, Illinois.  
 Contract CCA-25741.

## TUBE AND/OR CRYSTAL COMPLEMENT

No Electron Tubes or Crystals used.

## REFERENCE DATA AND LITERATURE

NAVSHIPS 91087: Technical Manual for Impedance Measuring Unit CA-1280 and Navy Department Impedance Bridge Type ZM-6/U.

## FUNCTIONAL DESCRIPTION

The ZM-6/U is a portable instrument designed to measure impedance in terms of reactance and resistance by the substitution method in a series resonance circuit.

No field changes in effect at time of preparation (18 April 1958).

## RELATION TO OTHER EQUIPMENT

The ZM-6/U is the same as Civil Aeronautics Administration Type CA-1280 Impedance Measuring Unit.

TYPE CLASSIFICATION  
 DESIGN COGNIZANCE BUAER  
 PROCUREMENT COGNIZANCE  
 STOCK NO.  
 R.D.B. IDENT. NO.

## EQUIPMENT SUPPLIED DATA

QUANTITY PER EQUIPT	NAME AND NOMENCLATURE	OVERALL DIMENSIONS (inches)	WEIGHT (lbs.)
1	Impedance Bridge ZM-6/U	8 X 10 X 18	

## PROBE AND TRANSMISSION LINE

14007

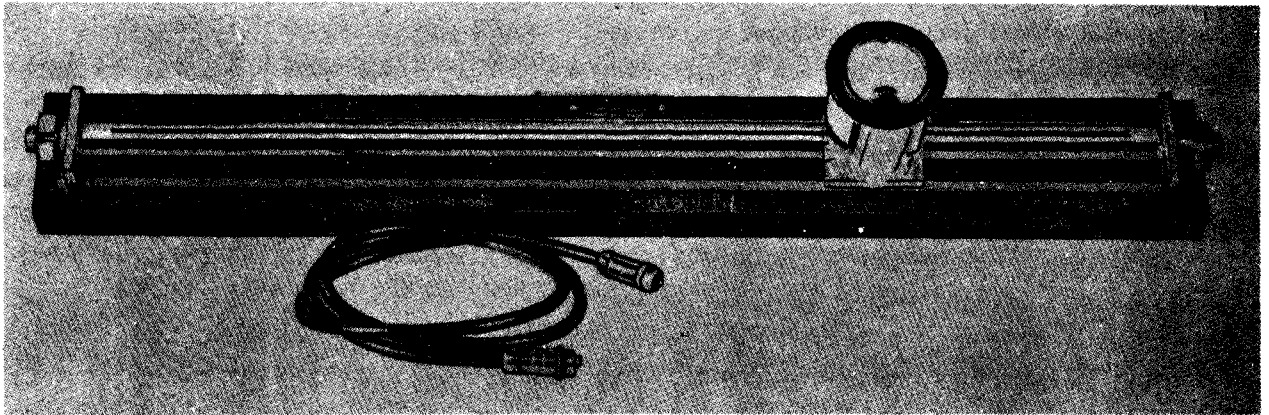

Probe and Transmission Line 14007

## FUNCTIONAL DESCRIPTION

The 14007 provides a means for measuring the standing wave ratio of the transmitting antenna system of the model YL Radio Beacon Equipment. The results of such measurements indicate to the operating personnel whether or not the antenna system is operating properly. It is designed for measurements at frequencies in the region of 246 megacycles. A calibration curve to correct the probe meter readings to relative volts is provided with the unit.

The slotted concentric line is mounted on a base channel iron by means of two metal blocks. The ends of the outer sheath are fitted with clamping nuts. The resulting assembly clamps in place the insulators which support the inner conductor. A receptacle is provided at each end for connection to the transmitter and the antenna system. A metal scale is mounted on the base parallel to the slotted outer sheath for indicating the position of the maximum and minimum points of the standing wave.

No field changes in effect at time of preparation (12 October 1956).

## ELECTRICAL AND MECHANICAL CHARACTERISTICS

FREQUENCY RANGE: 241 to 251 mc.  
 INDICATOR: Meter type.  
 METER SCALE: 0 to 100 uamp.  
 IMPEDANCE: 50 ohms.

## MANUFACTURER'S OR CONTRACTOR'S DATA

Federal Telephone and Radio Corp, Newark  
 N.J. Parts No. RA-1884-14 Rev A.

## TUBE AND/OR CRYSTAL COMPLEMENT

No Electron Tubes.

## REFERENCE DATA AND LITERATURE

Technical Manual for Navy Model YL Radio  
 Beacon Equipment.  
 NAVSHIPS 900-249-IB.

TYPE CLASSIFICATION
DESIGN COGNIZANCE BUSHIPS
PROCUREMENT COGNIZANCE
STOCK NO.

## EQUIPMENT SUPPLIED DATA

QUANTITY PER EQUIPT	NAME AND NOMENCLATURE	OVERALL DIMENSIONS (inches)	WEIGHT (lbs.)
1	Probe and Transmission Line NT-14006	3 x 7 x 35	31

February 1960

Test-Impedance and Standing Wave Ratio

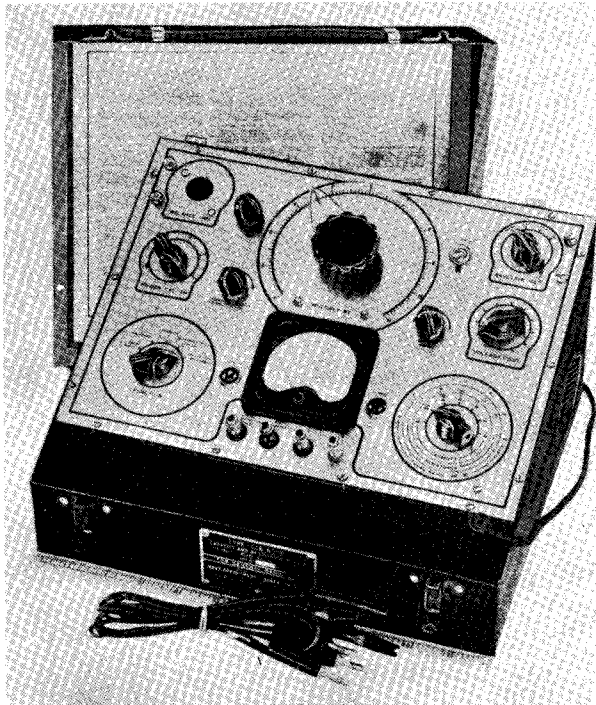
**CAPACITY AND RESISTANCE BRIDGE****60007***Capacity and Resistance Bridge 60007***FUNCTIONAL DESCRIPTION**

Capacity and Resistance Bridge 60007 is a self-contained portable equipment. It is a low frequency bridge for the measurement of capacitance, resistance, and transformer turns ratio. It contains facilities for polarizing electrolytic condensers while their capacitance and power factor are being determined and also for measuring their direct leakage current. Insulation resistance can be determined up to 2500 megohms.

No field changes in effect at time of preparation (3 September 1959).

**RELATION TO OTHER EQUIPMENT**

This equipment has been superseded by Capacitance-Inductance-Resistance Bridge ZM-11/U which is physically smaller and lighter and performs more functions.

**ELECTRICAL AND MECHANICAL CHARACTERISTICS**

POWER REQUIREMENTS: 35 W, 115 v. 50 to 60

cy, 1 ph.

**RANGES**

CAPACITANCE: 10 uuf to 100 uf.

ELECTROLYTIC LEAKAGE CURRENT: 0 to 1, 2.5, 5 ma.

INSULATION RESISTANCE: Up to 2,500 meg.

POLARIZATING VOLTAGE: 0 to 550 v dc.

POWER FACTOR: 0 to 50%.

RESISTANCE: 1.0 ohm to 1.0 meg.

TURNS RATIO: 0.001 to 1,000.

ACCURACY:  $\pm 5\%$ .

**MANUFACTURER'S OR CONTRACTOR'S DATA**

Clough-Brengle Co., Chicago, Illinois.

Contract NXs-4516.

Contract NXs-16844.

Contract NXsr-37247, dated 14 September 1943.

**TUBE AND/OR CRYSTAL COMPLEMENT**

(1) 5U4G (1) 6E5 (1) 6SJ7

Total Tubes: (3)

No Crystals used.

**REFERENCE DATA AND LITERATURE**

NAVSHIPS 900,628: Technical Manual for NT-60007 CAPACITY AND RESISTANCE BRIDGE.

TYPE CLASSIFICATION (NAVY) L/STD  
 DESIGN COGNIZANCE USN, BUSHIPS  
 PROCUREMENT COGNIZANCE  
 STOCK NO.  
 R.D.B. IDENT. NO. 6.1.4.5

**CAPACITY AND RESISTANCE BRIDGE**

**60007**

**SHIPPING DATA**

NUMBER OF BOXES	CONTENTS AND IDENTIFICATION	VOLUME (Cu.Ft.)	OVERALL DIMENSIONS (inches)	WEIGHT PACKED (lbs.)
1	Capacity and Resistance Bridge 60007	2.9		23

**EQUIPMENT SUPPLIED DATA**

QUANTITY PER EQUIPT	NAME AND NOMENCLATURE	OVERALL DIMENSIONS (inches)	WEIGHT (lbs.)
1	Capacity and Resistance Bridge 60007 Including:	7-1/8 X 10-1/2 X 12	18
2	Technical Manuals NAVSHIPS 900,628		
3	Test Leads	72 Tg	

April 1958

## VACUUM TUBE MEGOHMMETER

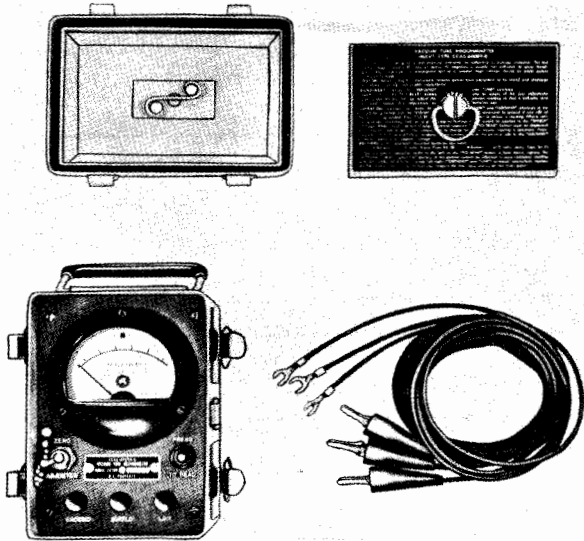
60089, 60089-A,  
60089-B

60089-B

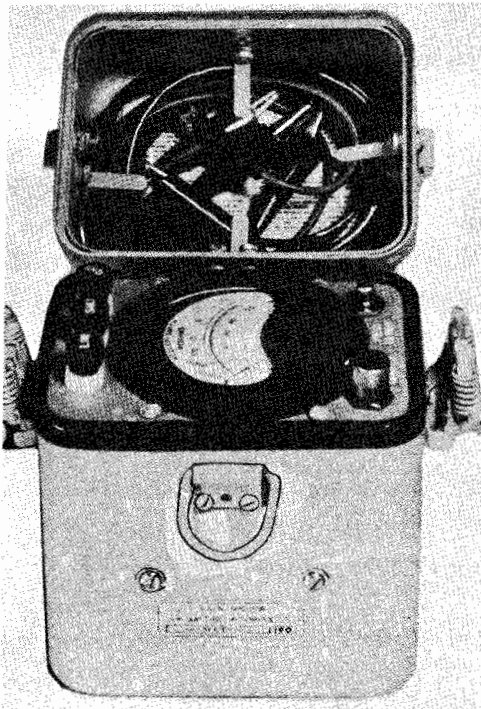

60089

*Vacuum Tube Megohmmeter*

60089-A

**FUNCTIONAL DESCRIPTION**

The NT-60089, NT-60089-A and NT-60089-B are designed to test electrical insulation by indicating its leakage resistance. It may also be used to determine the leakage resistance of capacitors and to measure the resistance of single resistors.

The instruments operate like a standard ohmmeter, except that a push button must be pressed to obtain the reading. Also provision is made to eliminate the influence of surface leakage (such as in cables) on readings.

No field changes in effect at time of preparation (17 March 1958).

**RELATION TO OTHER EQUIPMENT**

The NT-60089 is identical with Weston Model 799.

Equipment Required but not Supplied: (1) 1.5 v Battery BA-30, (1) 67.5 v Battery BA-51.



Test-Impedance and Standing Wave Ratio

**60089. 60089-A, VACUUM TUBE MEGOHMMETER  
60089-B**

April 1958

**ELECTRICAL AND MECHANICAL CHARACTERISTICS**

RANGE: 0.1 to 10,000 megohms in 1 range.  
 ACCURACY:  $\pm 1/8$  in. of arc at any point on  
 meter scale.  
 POWER SOURCE REQUIRED: 2 batteries; (1) 1.5  
 v BA-30 and (1) 67.5 v BA-51.

**MANUFACTURER'S OR CONTRACTOR'S DATA**

Weston Electrical Instrument Corp, Newark,  
 N. J.

Contract NObsr-30147, dated 29 June  
 1945. (60089).

Contract NXsr-59072, dated 26 April  
 1944.

Reiner Electronics Co. Inc.

Contract NObsr-59443, dated 16 June  
 1952. (60089-A).

Electronic Instrument Co, Brooklyn, N. Y.  
 (60089-B).

**TUBE AND/OR CRYSTAL COMPLEMENT**

(1) 1LH4  
 Total Tubes: (1)  
 No Crystals Used.

**REFERENCE DATA AND LITERATURE**

NAVSHIPS 900,744: Technical Manual for Va-  
 cuum Tube Megohmmeter Navy Type CV-60089.  
 NAVSHIPS 92311: Technical Manual for Vacuum  
 Tube Megohmmeter Navy Type CALN-60089-A.  
 NAVSHIPS 92410: Technical Manual for Vacuum  
 Tube Megohmmeter Navy Type CCAS-60089-B.

TYPE CLASSIFICATION
DESIGN COGNIZANCE BUSHIPS
PROCUREMENT COGNIZANCE MIL-M-15646(SHIPS)
STOCK NO.
R.D.B. IDENT. NO.

**SHIPPING DATA**

NUMBER OF BOXES	CONTENTS AND IDENTIFICATION	VOLUME (Cu.Ft.)	OVERALL DIMENSIONS (inches)	WEIGHT PACKED (lbs.)
1	Vacuum Tube Megohmmeter NT-60089			
1	Vacuum Tube Megohmmeter NT-60089-A			
1	Vacuum Tube Megohmmeter NT-60089-B	5.5	9 X 10 X 10-1/2	10

**EQUIPMENT SUPPLIED DATA**

QUANTITY PER EQUIPT	NAME AND NOMENCLATURE	OVERALL DIMENSIONS (inches)	WEIGHT (lbs.)
	60089		
1	Vacuum Tube Megohmmeter NT-60089	3-1/4 X 4-7/8 X 5-3/8	3.0
1	Oak Carrying Case	4-5/8 X 6-1/2 X 7-1/2	2.0
3	Test Lead	48 lg.	0.18
1	Carrying Strap	48 lg.	0.14
	60089-A		
1	Vacuum Tube Megohmmeter NT-60089-A	4-7/16 X 6-1/16 X 6-3/8	3.75
3	Test Lead	48 lg.	0.18
	60089-B		
1	Vacuum Tube Megohmmeter NT-60089-B	4-3/4 X 5-3/8 X 6-7/16	3
3	Test Lead	48 lg.	
2	Technical Manual NAVSHIPS 92410	1/4 X 8-1/2 X 11	

UNCLASSIFIED

April 1958

Test-Impedance and Standing Wave Ratio  
**SLOTTED LINE 805A (HEWLETT PACKARD)**

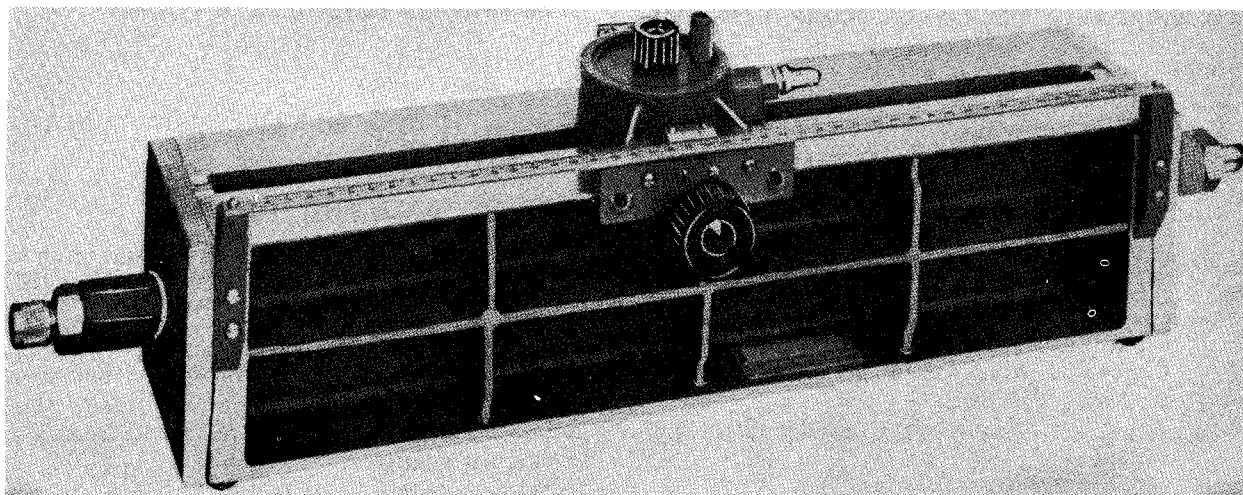

*Slotted Line 805A (Hewlett Packard)*

**FUNCTIONAL DESCRIPTION**

The (Hewlett-Packard) 805A is a portable instrument used in measuring standing wave ratio.

No field changes in effect at time of preparation (18 June 1958).

**ELECTRICAL AND MECHANICAL CHARACTERISTICS**

FREQUENCY RANGE: 500 to 4,000 mc.

IMPEDANCE: 50 ohms.

RESIDUAL SWR: 1.04.

CALIBRATION: Metric, calibrated in cm and mm. Vernier permits reading to 0.1 mm.

**MANUFACTURER'S OR CONTRACTOR'S DATA**

Hewlett-Packard Co., Palo Alto, Calif.

Contract NObsr-75041.

**TUBE AND/OR CRYSTAL COMPLEMENT**

No Electron Tubes used.

(1) 1N21B

Total Crystals: (1)

**REFERENCE DATA AND LITERATURE**

NAVSHIPS 91889: Instruction and Operating Manual for slotted line Model 805-A.

TYPE CLASSIFICATION  
DESIGN COGNIZANCE  
PROCUREMENT COGNIZANCE  
STOCK NO.  
R.D.B. IDENT. NO.

**SHIPPING DATA**

NUMBER OF BOXES	CONTENTS AND IDENTIFICATION	VOLUME (Cu.Ft.)	OVERALL DIMENSIONS (inches)	WEIGHT PACKED (lbs.)
1	Slotted Line Model 805-A			75

**EQUIPMENT SUPPLIED DATA**

QUANTITY PER EQUIPT	NAME AND NOMENCLATURE	OVERALL DIMENSIONS (inches)	WEIGHT (lbs.)
1	Slotted Line 805-A	6 X 8 X 27	
1	Carrying Case	9-1/2 X 9-1/2 X 29	

UNCLASSIFIED

4.6 805A (Hewlett Packard): 1