

NAVSHIPS 900,389-IB

RESTRICTED

INSTRUCTION BOOK

for

NAVY MODELS TDE,
TDE-1, TDE-2

RADIO TELEGRAPH
AND TELEPHONE TRANSMITTING EQUIPMENT

Westinghouse Electric & Manufacturing Company

Radio Division

Baltimore, Maryland

NAVY DEPARTMENT

BUREAU OF SHIPS

CONTRACT NXs-3179
CONTRACT NXs-20802
CONTRACT NXss-33634
CONTRACT NXsr-38682

I.B. 7334

APPROVED 21 Aug. 1945

RESTRICTED

ADDRESS NAVY DEPARTMENT,
BUREAU OF SHIPS

Section 993-100
REFER TO FILE NO.

NAVY DEPARTMENT

BUREAU OF SHIPS
WASHINGTON 25, D. C.



20 August 1945

1. NAVSHIPS 900,389 is the instruction book for Radio Telegraph and Telephone Transmitting equipment, Navy Models TDE/1/2. It is in effect upon receipt.
2. NAVSHIPS 900,389 is a RESTRICTED non-registered publication and shall be handled, transported, and safeguarded in accordance with U.S. Naval Regulations. When superseded by a later edition, this publication shall be destroyed.
3. Any person known to be in the service of the United States and persons of undoubted loyalty and discretion who are cooperating in Government work may have access to this publication. However, information contained herein shall not be communicated to the public or to the press.
4. This document contains information affecting the National defense of the United States within the meaning of the Espionage Act, 50 U.S.C., 31 and 32, as amended. Its transmission or the revelation of its contents in any manner to an unauthorized person is prohibited by law. (ART. 76 U.S.N. REGS-1920)
5. Extracts from this publication may be made to facilitate the preparation of other Navy instruction books and handbooks.
6. Copies of this publication should be obtained from the nearest Electronics Officer.

E. L. COCHRANE
Chief of Bureau

FROM BUREAU OF SHIPS, NAVY DEPARTMENT, WASHINGTON 25, D. C.

RESTRICTED

TABLE OF CONTENTS

Paragraph	Page
SECTION I—GENERAL DESCRIPTION	
1. Preface.....	1-1
Major Improvements in the TDE Series Equipments.....	1-1
2. General.....	1-3
3. List of Equipments.....	1-3
Navy Model TDE, 115 Volt D.C. Operation.....	1-4
Navy Model TDE, 230 Volt D.C. Operation.....	1-4
Navy Model TDE, 220/440 Volt, 3 Phase, 60 Cycle Operation.....	1-5
Navy Model TDE-1, 115 Volt D.C. Operation.....	1-5
Navy Model TDE-1, 230 Volt D.C. Operation.....	1-6
Navy Model TDE-1, 220/440 Volt, 3 Phase, 60 Cycle Operation or 208 Volt, 3 Phase, 60 Cycle Operation.....	1-6
Navy Model TDE-1, 115/230 Volt, 1 Phase, 60 Cycle Operation.....	1-7
Navy Model TDE-2, 115 Volt D.C. Operation.....	1-7
Navy Model TDE-2, 230 Volt D.C. Operation.....	1-8
Navy Model TDE-2, 220/440 Volt, 3 Phase, 60 Cycle Operation.....	1-8
4. Shipping Weights and Dimensions.....	1-9
Navy Model TDE, 115 Volt D.C. Supply.....	1-9
Navy Model TDE, 230 Volt D.C. Supply.....	1-9
Navy Model TDE, 220/440 Volt, 3 Phase, 60 Cycle Supply.....	1-9
Navy Model TDE-1, 115 Volt D.C. Supply.....	1-10
Navy Model TDE-1, 230 Volt D.C. Supply.....	1-10
Navy Model TDE-1, 220/440 Volt, 3 Phase, 60 Cycle or 208 Volt, 3 Phase, 60 Cycle Supply.....	1-10
Navy Model TDE-1, 115/230 Volt, 1 Phase, 60 Cycle Supply.....	1-11
Navy Model TDE-2, 115 Volt D.C. Supply.....	1-11
Navy Model TDE-2, 230 Volt D.C. Supply.....	1-11
Navy Model TDE-2, 220/440 Volt, 3 Phase, 60 Cycle Supply.....	1-11
SECTION II—THEORY OF OPERATION	
5. General.....	2-0
6. Radio Transmitter Unit.....	2-0
Common Components.....	2-1
Intermediate Frequency Section.....	2-2
High Frequency Section.....	2-3
7. Motor-Generator and Rectifier Power Unit.....	2-4
8. Remote Control Unit, Navy Type CAY-23305.....	2-6
9. Remote Control Unit, Navy Type CAY-23381.....	2-6
10. Autotransformer, Navy Type CAY-301145.....	2-6
SECTION III—INSTALLATION AND INITIAL ADJUSTMENTS	
11. General.....	3-1
12. Rating and Range.....	3-2
Power Supply Line Requirements.....	3-2
13. Power Input Voltage Supply Checks.....	3-2
Motor.....	3-3
Link Switches.....	3-3
Indicator Light Resistors.....	3-4
Starting Contactor Holding Coil Resistors.....	3-4
Starting Contactor Coil.....	3-4
Starting Contactor Heaters.....	3-5
Transformer Links.....	3-5
Fuses.....	3-5
14. Control Units.....	3-5

TABLE OF CONTENTS (Cont.)

Paragraph	Page
SECTION III—INSTALLATION AND INITIAL ADJUSTMENTS (Cont.)	
15. Checking.....	3-7
Power Equipment and Control Circuit Tests.....	3-7
Preliminary Transmitter Operation Tests.....	3-9
Application of Filament Power to all Tubes.....	3-9
Setting of Power and Tuning Controls for H.F.....	3-9
Application of Plate and Screen Potential to Tubes and H.F. Tuning Adjustments.....	3-10
Setting of Power and Tuning Controls for I.F.....	3-11
Application of Plate and Screen Potential to Tubes and I.F. Tuning Adjustments.....	3-11
Remote Control Unit Tests.....	3-12
SECTION IV — OPERATION	
16. Overload Protection.....	4-1
17. Tuning Procedures.....	4-1
General.....	4-1
18. High Frequency Circuit Tuning.....	4-2
19. Antenna Characteristics and Tuning.....	4-3
General.....	4-3
High Frequency Antenna Tuning.....	4-3
Intermediate Frequency Antenna Tuning.....	4-3
20. Intermediate Frequency Circuit Tuning.....	4-4
21. Routine Operation.....	4-5
To Start and Stop Equipment.....	4-5
To Change Frequency.....	4-5
To Increase or Decrease Power CW-MCW Operation.....	4-5
Voice Operation.....	4-5
MCW Operation.....	4-5
SECTION V — PREVENTIVE MAINTENANCE	
22. General, Transmitter.....	5-0
23. Motor-Generator.....	5-1
Contactor.....	5-2
24. Lubrication.....	5-2
Transmitter Unit.....	5-2
Motor-Generator Set.....	5-2
25. Maintenance Schedule.....	5-3
Daily.....	5-3
Weekly.....	5-3
Monthly.....	5-3
Semi-annually.....	5-3
26. Troubles and Causes.....	5-3
Operating Start-Stop Switch S-204 Does Not Operate the Starting Solenoid.....	5-3
Start-Stop Switch S-204 Causes Starting Contactor to Close, but Motor-Generator Set Does Not Start.....	5-3
Contactor Tends to Close, But Will Not Stay Closed.....	5-3
Motor-Generator Runs Satisfactorily, But Low or No Plate Voltage At Transmitter.....	5-3
No Filament Voltage.....	5-4
Operating Test Key Causes No Indication on Grid Current Meter.....	5-4
Operating Test Key Does Not Operate Keying Relay.....	5-4
Operating Remote Key Does Not Operate Keying Relay.....	5-4
Operating Microphone "Push-to-Talk" Button Does Not Key Transmitter.....	5-4
Transmitter Does Not Modulate When Operating On MCW.....	5-4
Transmitter Does Not Modulate When Operating on Voice.....	5-4
Grid Current Meters Indicate Subnormal Values.....	5-4
Amplifier Circuits Do Not Tune Properly.....	5-4

TABLE OF CONTENTS (Cont.)

Paragraph	Page
SECTION V—PREVENTIVE MAINTENANCE (Cont.)	
Amplifier Circuits Do Not Tune No Antenna Current.....	5-5
Set Operates Normally When Test Key S-208 is Down, But Tubes Continue to Draw Some Plate Current When Key is Up.....	5-5
Set Operates Normally, But Power Amplifier Grid Current is Higher than Normal.....	5-5
All Stages Appear to Function and Tune Properly, but no Grid or Plate Current Can be Obtained on Power Amplifier.....	5-5
Amplifier Tubes Heat Excessively when Test Key S-208 is closed and Antenna Circuit is in Tune	5-5
Frequency Skips or Jumps.....	5-5
On D.C. Equipments, Motor-Generator Runs but at Too Low a Speed.....	5-5
On D.C. Equipments, Motor Generator Runs but at Too High a Speed.....	5-5
Generator Heating.....	5-5
Field Coil Heating.....	5-5
Poor Commutation and Sparking at Brushes.....	5-5
Failure of Generator to Build Up.....	5-6
SECTION VI—VACUUM TUBE DATA	
27. Vacuum Tubes Employed.....	6-0
28. Vacuum Tube Characteristics.....	6-1
Navy Type 801 Tube as A Class C Oscillator.....	6-1
Navy Type 801 Tube as an Audio Amplifier Class A.....	6-1
Navy Type 837 Tube as an Electron Coupled Oscillator.....	6-2
Navy Type 807 Tube.....	6-2
Navy Type 803 Tube as a Class C Amplifier CW.....	6-2
Navy Type 803 Tube as a Suppressor Modulated Class C Amplifier.....	6-3
Navy Type 5U4G Tube.....	6-3
SECTION VII—SERIES PARTS LISTS	
Electrical Parts for Model TDE Series Radio Transmitting Equipments.....	7-1
SECTION VIII—ILLUSTRATIONS	
Photographs—see page iii for Titles.....	8-1
Drawings—see page iii for Titles.....	8-15
SECTION IX—COMMERCIAL BULLETINS	
See page vi for Titles.....	9-1

LIST OF ILLUSTRATIONS

Figure	Title	Page
1-1	Frontispiece. A Typical Model TDE Transmitter-Power Unit (Photo C-5921).....	1-0
8-1	Transmitter Units, Navy Type CAY-52267 and Power Unit, Navy Type CAY-21848, CAY-21849, or CAY-21850. Front Left Oblique View, Access Doors Closed. (Photo C-5921).....	8-1
8-2	Transmitter Unit, Navy Type CAY-52267A and Power Unit, Navy Type CAY-21848, CAY-21849, CAY-21850, or CAY-211030. Front View, Access Doors Closed. (Photo C-7301).....	8-2
8-3	Transmitter Unit, Navy Type CAY-52267 and Power Unit, Navy Type CAY-21848, CAY-21849, or CAY-21850. Front View, Access Doors Open. (Photo C-5920)	8-3
8-4	Transmitter Unit, Navy Type CAY-52267 and Power Unit, Navy Type CAY-21848, CAY-21849, or CAY-21850. Front Left Oblique View, Access Panel Removed, Transmitter out 45°. (Photo C-5916).....	8-4
8-5	Transmitter Unit, Navy Type CAY-52267A and Power Unit, Navy Type CAY-21848, CAY-21849, CAY-21850, or CAY-211030. Front Right Oblique View, Access Panel Removed, Transmitter out 45°. (Photo C-7302).....	8-5
8-6	Transmitter Unit, Navy Type CAY-52267 and Power Unit, Navy Type CAY-21848, CAY-21849, or CAY-21850. Front Right Oblique View, Access Panel Removed, Transmitter out 90°. (Photo C-5914).....	8-6
8-7	Transmitter Unit, Navy Type CAY-52267 or CAY-52267A, Removed From Case, Left Side View. (Photo C-5917).....	8-7
8-8	Transmitter Unit, Navy Type CAY-52267 or CAY-52267A, Removed From Case, Right Side View. (Photo C-5915).....	8-8
8-9	Transmitter Unit, Navy Type CAY-52267, Removed From Case, Rear View. (Photo C-5919).....	8-9
8-10	Transmitter Unit, Navy Type CAY-52267A, Removed From Case, Rear View. (Photo C-7298).....	8-10
8-11	Power Unit, Navy Type CAY-21848, CAY-21849, CAY-21850 or CAY-211030, Removed From Case, Front Right Oblique View, Access Door in Place. (Photo C-5924).....	8-11
8-12	Power Unit, Navy Type CAY-21848, CAY-21849, CAY-21850 or CAY-211030, Removed From Case, Front Right Oblique View, Access Door and Shields Removed. (Photo C-5923).....	8-11
8-13	Remote Control Unit, Navy Type CAY-23305, Front Oblique View, Cover Removed. (Photo C-5918).....	8-12
8-14	Remote Control Unit, Navy Type CAY-23305, Rear View, Cover Removed. (Photo C-5922).....	8-12
8-15	Remote Control Unit, Navy Type CAY-23381. Composite Front View. (Photo C-7300)	8-13
8-16	Autotransformer, Navy Type CAY-301145, Front Oblique View. (Photo C-7299).....	8-13
8-17	Transmitter Unit and Power Unit, Navy Model TDE, Outline and Mounting Dimensions. (Dwg. 7608991).....	8-15
8-18	Transmitter Unit and Power Unit, Navy Models TDE-1 and TDE-2. Outline and Mounting Dimensions. (Dwg. 7610769).....	8-17
8-19	Transmitter Unit, Navy Models TDE-1 and TDE-2. Outline and Mounting Dimensions. (Dwg. 7610770).....	8-19
8-20	Power Unit and Plate Rheostat for Navy Models TDE-1 and TDE-2. Outline and Mounting Dimensions. (Dwg. 7610771).....	8-21

LIST OF ILLUSTRATIONS (Cont.)

Figure	Title	Page
8-21	Remote Control Unit, Type CAY-23305 for Navy Model TDE. Outline and Mounting Dimensions. (Dwg. 7408403).....	8-23
8-22	Remote Control Unit, Type CAY-23381 for Navy Model TDE-1 and TDE-2. Outline and Mounting Dimensions. (Dwg. 7710645).....	8-25
8-23	Autotransformer, Type CAY-301145 for Navy Model TDE-1. Outline and Mounting Dimensions. (Dwg. 7411841).....	8-27
8-24	Transmitter Unit, Power Unit, and Remote Control Unit, Schematic Diagram for Navy Model TDE. (Dwg. 7300512).....	8-29
8-25	Transmitter Unit, Power Unit, and Remote Control Unit, Schematic Diagram for Navy Models TDE-1 and TDE-2. (Dwg. 7300540).....	8-31
8-26	Transmitter Unit, Power Unit, and Remote Control Unit, Schematic Diagram for Navy Model TDE-2. (Dwg. 7300577).....	8-33
8-27	Transmitter Unit, Wiring Diagram for Navy Model TDE. (Dwg. 7300501).....	8-35
8-28	Transmitter Unit, Wiring Diagram for Navy Models TDE-1 and TDE-2. (Dwg. 7300541).....	8-37
8-29	Transmitter Unit, Wiring Diagram for Navy Model TDE-2. (Dwg. 7300578).....	8-39
8-30	Power Unit, Wiring Diagram for Navy Models TDE, TDE-1 and TDE-2. (Dwg. 7300514).....	8-41
8-31	Remote Control Unit, Type CAY-23305, Wiring Diagram for Navy Model TDE. (Dwg. 7708883).....	8-43
8-32	Remote Control Unit, Type CAY-23381, Wiring Diagram for Navy Models TDE-1 and TDE-2. (Dwg. 7710408).....	8-45
8-33	Westinghouse Control Unit, Interconnection Diagram for Navy Model TDE. (Dwg. 7709051).....	8-47
8-34	Westinghouse Control Unit, Interconnection Diagram for Navy Models TDE-1 and TDE-2. (Dwg. 7710309).....	8-49
8-35	Standard Navy Six Wire Control Unit, Interconnection Diagram for Navy Model TDE. (Dwg. 7709052).....	8-51
8-36	Standard Navy Six Wire Control Unit, Interconnection Diagram for Navy Models TDE-1 and TDE-2. (Dwg. 7710308).....	8-53
8-37	Standard Navy Four Wire Control Unit, Interconnection Diagram for Navy Model TDE. (Dwg. 7709053).....	8-55
8-38	Standard Navy Four Wire Control Unit, Interconnection Diagram for Navy Models TDE-1 and TDE-2. (Dwg. 7710307).....	8-57
8-39	Navy Radiophone Unit, Interconnection Diagram for Navy Model TDE. (Dwg. 7709149).....	8-59
8-40	Navy Radiophone Unit, Interconnection Diagram for Navy Models TDE-1 and TDE-2. (Dwg. 7710310).....	8-61
8-41	Transmitter Unit, Power Unit, and Control Unit, Interconnection Diagram for Navy Models TDE, TDE-1 and TDE-2. (Dwg. 7610772).....	8-63
8-42	Tuning Curve for High Frequency Master Oscillator, Controls B and C. (Curve 271475)	8-65
8-43	Tuning Curve for High Frequency Multiplier, Controls D and E. (Curve 271476).....	8-65
8-44	Tuning Curve for High Frequency Intermediate Amplifier, Controls F and G. (Curve 271477).....	8-66

LIST OF ILLUSTRATIONS (Cont.)

Figure	Title	Page
8-45	Tuning Curve for Intermediate Frequency Master Oscillator, Controls O and P. (Curve 271098).....	8-66
8-46	Tuning Curve for Intermediate Frequency Power Amplifier, Controls Q and R. (Curve 271099).....	8-67
8-47	Standard Colpitts Oscillator Circuit and Electron Coupled Oscillator Circuit. (Dwg. 7705422).....	8-67
8-48	Antenna Characteristics, Intermediate Frequency Transmitter. (Dwg. 7709571).....	8-68
8-49	Antenna Characteristics, High Frequency Transmitter. (Dwg. 7709570).....	8-69
8-50	Keying Relay Adjustments. (Dwg. 7405832).....	8-70
8-51	Contactors and Relay Operating Table.....	8-70
8-52	Typical Dial Settings and Meter Readings, Intermediate Frequency Range.....	8-71
8-53	Typical Dial Settings and Meter Readings, High Frequency Range.....	8-72
8-54	Transformers, Outline and Mounting Dimensions. (Dwg. 7715110).....	8-73
8-55	Coils and Chokes, Outline and Mounting Dimensions. (Dwg. 7614767).....	8-75
8-56	Coils and Chokes, Outline and Mounting Dimensions. (Dwg. 7614768).....	8-77

PLANS FOR RECORD DRAWINGS

Drawing	Sheet		Page
CAY-T-160	1	Index (Dwg. 7614510).....	8-79
CAY-T-160	2	Motor, Type CAY-21851, 115 V.D.C., a Unit of Type CAY-21848 Rectifier Power Unit for Navy Models TDE and TDE-1. Outline, Winding Data and Specifications. (Dwg. 36-J-143).....	8-81
CAY-T-160	3	Motor, Type CAY-21852, 230 V.D.C., a Unit of Type CAY-21849 Rectifier Power Unit for Navy Models TDE and TDE-1. Outline, Winding Data and Specifications. (Dwg. 36-J-146).....	8-83
CAY-T-160	4	Motor, Type CAY-21853, 220/440 V., 3 Phase, 60 Cycle, a Unit of Type CAY-21850 Rectifier Power Unit for Navy Models TDE and TDE-1. Outline, Winding Data and Specifications. (Dwg. 36-J-140)	8-85
CAY-T-160	5	Motor, Type CAY-211031, 115/230 V., 1 Phase, 60 Cycle, a Unit of Type CAY-211030 Rectifier Power Unit for Navy Model TDE-1. Outline Winding Data and Specifications. (Dwg. 36-J-156).....	8-87
CAY-T-160	6	Motor, Type CAY-21851, 115 V.D.C., a Unit of Type CAY-21848 Rectifier Power Unit for Navy Model TDE-2. Outline, Winding Data and Specifications. (Dwg. 38-J-803).....	8-89
CAY-T-160	7	Motor Type CAY-21852, 230 V. D. C., a Unit of Type CAY-21849 Rectifier Power Unit for Navy Model TDE-2. Outline, Winding Data and Specifications. (Dwg. 38-J-806).....	8-91
CAY-T-160	8	Motor, Type CAY-21853, 220/440 V., 3 Phase, 60 Cycle, a Unit of Type CAY-21850 Rectifier Power Unit for Navy Model TDE-2. Outline, Winding Data and Specifications. (Dwg. 38-J-800).....	8-93
CAY-T-160	9	Generator, Type CAY-21854, a Unit of Types CAY-21848, CAY-21849, CAY-21850 and CAY-211030 Rectifier Power Units for Navy Models TDE and TDE-1. Outline, Winding Data and Specifications. (Dwg. 36-J-141).....	8-95
CAY-T-160	10	Generator, Type CAY-21854, a Unit of Types CAY-21848, CAY-21849, CAY-21850 Rectifier Power Units for Navy Model TDE. Outline, Winding Data and Specifications. (Dwg. 38-J-802.1).....	8-97
CAY-T-160	11	Motor-Generator, Type CAY-211159, 115 V.D.C., a Unit of Rectifier Power Unit, Type CAY-21848, for Navy Models TDE and TDE-1. Outline and Coupling Data. (Dwg. 36-J-145).....	8-99
CAY-T-160	12	Motor-Generator, Type CAY-211160, 230 V.D.C., a Unit of Rectifier Power Unit, Type CAY-21849, for Navy Models TDE and TDE-1. Outline and Coupling Data. (Dwg. 36-J-148).....	8-101
CAY-T-160	13	Motor-Generator, Type CAY-211161, 220/440 V., 3 Phase, 60 Cycle, a Unit of Rectifier Power Unit, Type CAY-21850, for Navy Models TDE and TDE-1. Outline and Coupling Data. (Dwg. 36-J-142).....	8-103
CAY-T-160	14	Motor-Generator, 115/230 V., 1 Phase, 60 Cycle, a Unit of Rectifier Power Unit, Type CAY-211030, for Navy Model TDE-1. Outline and Coupling Data. (Dwg. 36-J-160).....	8-105
CAY-T-160	15	Motor-Generator, Type CAY-211159, 115 V.D.C., a Unit of Rectifier Power Unit, Type CAY-21848, for Navy Model TDE-2. Outline and Coupling Data. (Dwg. 38-J-805).....	8-107
CAY-T-160	16	Motor-Generator, Type CAY-211160, 230 V.D.C., a Unit of Rectifier Power Unit, Type CAY-21849, for Navy Model TDE-2. Outline and Coupling Data. (Dwg. 38-J-804).....	8-109
CAY-T-160	17	Motor-Generator, Type CAY-211161, 220/440 V., 3 Phase, 60 Cycle, a Unit of Rectifier Power Unit, Type CAY-21850, for Navy Model TDE-2. Outline and Coupling Data. (Dwg. 38-J-802).....	8-111

LIST OF COMMERCIAL BULLETINS

Westinghouse 35 Line Miniature Panel Instruments.....	IL 43-350-F	9-1
Westinghouse Type DN Contactors.....	IL 2546-B	9-3

CONTRACTUAL GUARANTEE:

The equipment, including all parts and spare parts, except vacuum tubes, is guaranteed for a service period of TWO YEARS with the understanding that, as a condition of this contract, all items found to be defective as to design, material, workmanship or manufacture shall be replaced without delay and at no expense to the Government; provided that such guarantee and agreement will not obligate the contractor to make replacement of defective material unless the failure, exclusive of normal shelf life deterioration, occurs within a period of FIVE YEARS from the date of delivery of the equipment to and acceptance by the Government and provided further, that if any part or parts (except vacuum tubes) fail in service or are found defective in ten per cent (10%) or more of the total number of equipments furnished under the contract, such part or parts, whether supplied in the equipment or as spares shall be conclusively presumed to be of defective design, and as a condition of contract subject to one hundred per cent (100%) replacement of all similar units supplied on subject contract by suitable redesigned replacements.

Failure due to poor workmanship while not necessarily indicating poor design, will be considered in the same category as failure due to poor design. Redesigned replacements which will assure proper operation of the equipment will be supplied promptly, transportation paid, to the Naval Activities using such equipment upon receipt of proper notice and without cost to the Government.

All such defective articles will be subject to rejection and return to the contractor.

This period of FIVE YEARS and the service period of TWO YEARS shall not include any portion of the time that the equipment fails to give satisfactory performance due to defective items and the necessity for replacement thereof, and provided further, that any replacement part shall be guaranteed to give TWO YEARS of satisfactory service.

The design of this equipment will be such that the vacuum tubes will operate within their published limits and in such a manner that a tube life of 2000 hours may be expected. Vacuum tubes of the 50 watt envelope size and larger will be guaranteed for 500 hours of service life, in accordance with the provisions of Specification RE-13A-600C.

REPORT OF FAILURE:

Report of Failure of any part of this equipment, during its service life, shall be made to the Bureau of Ships in accordance with current instructions. The report shall cover all details of the failure and give the date of installation of equipment. For procedure in reporting failures, see Chapter 67 of the "Bureau of Ships Manual", or superseding instructions.

INSTALLATION RECORD:

The blank spaces indicated below shall be filled in immediately upon completion of the initial service installation. The date of acceptance by the Navy can be determined by the stamped acceptance plate located on the transmitter. These dates are stamped in sequence of month, day and year.

Contract NXs-3179	Dated June 30, 1942
Contract NXss-20802	Dated June 1, 1943
Contract NXss-33634	Dated June 30, 1943
Contract NXsr-38682	Dated Oct. 6, 1943
Serial Number of equipment.....	
Date of acceptance by the Navy.....	
Date of delivery to contract destination.....	
Date of completion of installation.....	
Date placed in service.....	

REPLACEMENT MATERIAL:

All requests or requisitions for replacement material should include complete descriptive data covering the part desired, in the following form:

1. Name of part desired.
2. Federal Stock number (if assigned).
3. Navy Type number (if assigned) (including *prefix* and *suffix* as applicable).
4. Commercial designation.
5. Model designation (including *suffix*) of equipment in which used.
6. Navy Type designation (including *prefix* and *suffix* where applicable) of major unit in which part is used.
7. Contract, purchase order, requisition, etc., under which the equipment was procured.
8. Circuit symbol designation of part.
9. (a) Navy Drawing and/or specification number. (Include part or group number).
 (b) Manufacturer's drawing or specification's number. (Include part or group number).
10. Rating or other descriptive data.

WARNING

The attention of officers and operating personnel is directed to Chapter 67 of Bureau of Ships Manual or superseding instructions on the subject Radio—Safety precautions to be observed.

While every practicable safety precaution has been incorporated in this equipment, the following rules must be strictly observed:

KEEP AWAY FROM LIVE CIRCUITS.

Operating personnel must at all times observe all safety regulations. Do not change tubes or make adjustments inside the equipment with high voltage supply on. Under certain conditions dangerous potentials may exist in circuits with power controls in the off position due to charges retained by capacitors. To avoid casualties, always remove power and discharge and ground circuits prior to touching them.

DON'T SERVICE OR ADJUST ALONE.

Under no circumstances should any person reach within or enter the enclosure for the purpose of servicing or adjusting the equipment without the immediate presence or assistance of another person capable of rendering aid.

DON'T TAMPER WITH INTERLOCKS.

Do not depend upon door switches or interlocks for protection but always shut down motor generators or other power equipment. Under no circumstances should any access gate, door or safety interlock switch be removed, short circuited, or tampered with in any way, by other than authorized maintenance personnel, nor should reliance be placed upon the interlock switches for removing voltages from the equipment.

RESUSCITATION

AN APPROVED POSTER ILLUSTRATING THE RULES FOR RESUSCITATION BY THE PRONE PRESSURE METHOD SHALL BE PROMINENTLY DISPLAYED IN EACH RADIO, RADAR OR SONAR ENCLOSURE. POSTERS MAY BE OBTAINED UPON REQUEST TO THE BUREAU OF MEDICINE AND SURGERY.

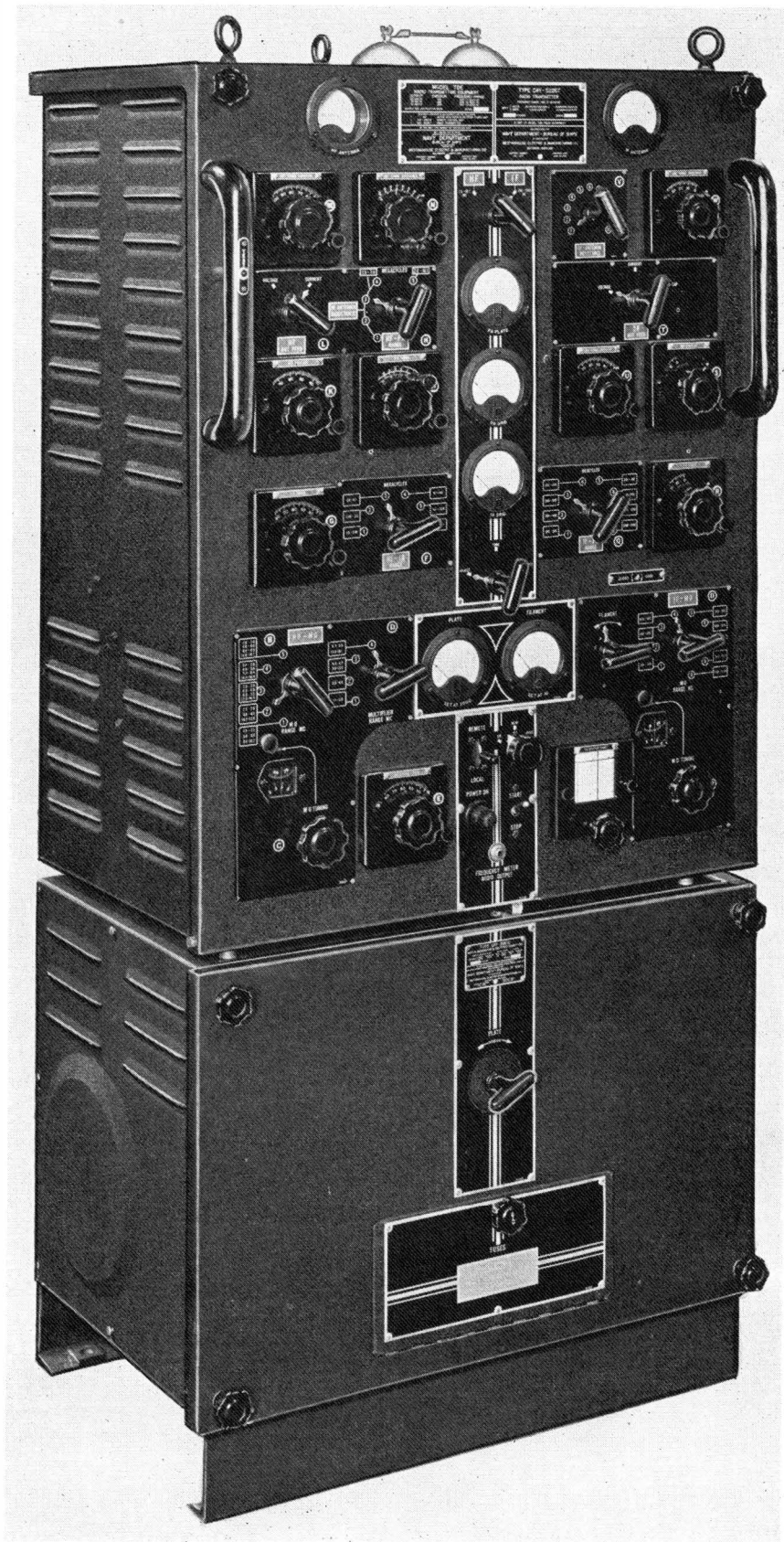

Figure 1-1. Frontspiece. A Typical Model TDE Transmitter-Power Unit (Photo C-5921)

I. GENERAL DESCRIPTION

1. PREFACE.

a. This instruction book has been written to cover Ship Type Navy Model TDE, TDE-1 and TDE-2 Radio Telegraph and Telephone Transmitting Equipments. Essentially, each model is similar in design and operating characteristics. However, improvements were made during production of the Model TDE unit,

likewise when the type designation of the equipments changed. Each new Model of the TDE Series has incorporated changes and additions in order to improve operating stability and efficiency. Therefore, for the convenience of the operator of these equipments, the listing below shows these improvements as made from model to model.

b. MAJOR IMPROVEMENTS IN THE TDE SERIES EQUIPMENTS.

	TDE (CAY-52267)	TDE-1 (CAY-52267A)	TDE-2 (CAY-52267A)
(1)	Power control rheostat not enclosed in case. Permanently fastened to Power Supply.	Later TDE and TDE-1 Equipments are equipped for removing and housing field rheostat in separate box.	Rheostat permanently installed in separate box which is removable in case operation of equipment is desired from a remote station.
(2)	Rheostat in the Navy Model TDE and TDE-1 Equipments was a 5000 ohm resistor. This rheostat consisted of two 4-inch plates connected in series.		Rheostat resistance increased to 7200 ohms to permit greater plate voltage control. It now consists of three 4-inch plates in series. Rheostats are electrically and mechanically interchangeable.
(3)	Equipment operated by means of Westinghouse 4-wire control toggle type, single throw, start-stop switch. A separate Navy Remote Unit could be used for 6-wire operation.	At Navy request, in order to permit greater control, 4- and 6-wire control units were incorporated into the TDE-1 and TDE-2 Equipments. The 4-wire control Start-Stop switch changed to pushbutton type; one position ON, other position OFF. For 6-wire control, which is optional, the 4-wire control switch is removed and replaced with a 6-wire control Start-Stop switch, pushbutton type momentary contact. See wiring diagrams for instructions on making changes.	
(4)	Remote control was obtained from Navy Model CAY-23305 Remote Control Unit.	In line with changes mentioned in Par. 1.b. (3), a new Remote Control Unit, Type CAY-23381, was installed to permit 4- and 6-wire control simply by changing from one switch to the other and making the necessary changes explained in this book.	
(5)	Early models did not include microphone jack on the front panel. Modification kit issued for this purpose. See Par. 1.b. (8).	In the TDE-1 and TDE-2 Equipments, this microphone jack is built into and included on the front panel.	
(6)	Intermediate Amplifier inoperative in ADJUST position of ADJUST-TUNE-OPERATE switch S-207.	At Navy request, the Intermediate Amplifier was rendered inoperative in ADJUST position by placing switch S-207B in the cathode circuit.	TDE-1 did not meet Navy Specifications regarding the frequency stability. Therefore, the ADJUST-TUNE-OPERATE switch S-207A, S-207B was changed to the screen and plate circuit of the Int. Amplifier.
(7)	Interlock was located at the rear bottom of the transmitter case.	In order to obtain better engagement during vibration, the position of the interlock switch was changed to the rear top of the transmitter.	

(8) As explained in Par. 1. b. (5), a microphone jack was added to some of the early TDE Equipments. These equipments did not include a jack to permit use of a local microphone. This feature was incorporated in the later TDE units and also in the TDE-1 and TDE-2 Equipments. Modification kits were supplied to make the early equipments conform with the later production sets.

(a) The following parts were necessary to make this addition possible: a three circuit jack, an extruded spacer, a nameplate and proper wires for the wiring changes.

(b) The microphone jack is located in the control panel on the lower front of the transmitter. It was added by moving the frequency meter audio output jack from the bottom center to the right side of the control panel. This made room for the microphone jack to be placed on the left side of the control panel. Procedure followed in order to accomplish this change, consisted of removing the frequency meter audio output jack from its control position, fastening the new nameplate to the bottom of the control panel and drilling two holes, each $\frac{1}{2}$ " in diameter, for the two jacks.

(c) The following changes made in the transmitter and power supply wiring, can best be understood by reference to Figs. 8-24, 8-27, and 8-30, Dwgs. 7300512, 7300501 and 7300514, respectively.

1. Wire between "Remote-Local" switch S-203D bottom and S-202A terminal 8 was removed.

2. Wire between S-202A and S-203D center was removed from S-203D center. It was reconnected to K-202A terminal 4.

3. Wire between TS3-7 and K-203 bottom was removed from K-203 and connected to S-203D bottom.

4. K-203 bottom and S-203D center were wired together.

5. Tip of microphone jack J-202 was wired to S-203D center.

6. TS3-8 was connected to ring of microphone jack J-202.

7. TS4-26 was connected to sleeve of microphone jack J-202.

8. In the power supply, TS11-27 was connected to TS11-28, and TS11-32 was connected to TS2-26.

(d) The local microphone jack is wired so that it is electrically in parallel with the remote microphone jack. This feature affords the local microphone direct control over the remote microphone, since it can be used in either the remote or local position.

(9) In order to expedite delivery of the first ten TDE Equipments, certain substitutions were allowed

and authorized by the Navy, on the motor-generator units. All parts of these special motor-generator sets are interchangeable electrically and mechanically with the production units with the exception of the following items.

(a) Cast iron bearing brackets have been substituted for malleable iron brackets. These cast iron brackets have a 0.010 larger diameter than the malleable iron brackets. Therefore, any replacement brushholder will be slightly loose, requiring an additional shim or cement to effectively retain the brushholder.

(b) The terminal board supplied with these first ten motor-generator units is mounted by a bolt which is one size larger than on the later production models. This makes it necessary to enlarge the mounting holes on the replacement terminal board to $9/32$ " diameter.

(10) It may be desired to move the plate voltage control from its position on the power supply to a new location at or near the transmitter. This is done when it is primarily desired to separate the transmitter from the power supply. Separation of the Motor-Generator and Rectifier Power Unit, Navy Types CAY-21848, CAY-21849, CAY-21850 and CAY-211030 may be found necessary or desirable for the following reasons:

(a) Insufficient space for both the transmitter and the power supply in the operating room.

(b) Where it is desirous to locate the power supply in a protected area below decks.

(c) Where operating room must be kept quiet.

(12) The Field Rheostat Plate Voltage Control may be removed and relocated in the following manner:

(a) Remove all power from equipment.

(b) Loosen the four knobs holding front panel of the power unit and remove the front panel.

(c) Disconnect two field leads from terminals TS11-37 and TS11-38 located on the small terminal board adjacent to the field rheostat box in the power unit. On some equipments, the control is not enclosed in a case. In these instances, it is merely necessary to remove the three leads from both terminals of the control.

(d) Remove three #10-32 mounting screws holding the rheostat assembly in place and move this assembly to its new location.

(e) On the few equipments which do not have the rheostat enclosed in a case, splice to the single lead removed from one of the terminals a suitable length of #14 or larger wire which is insulated for 230 volts. The two leads on the other terminal of the control are spliced together after being removed from the control. Connect wire similar to that used on the single lead to terminal TS11-17.

(f) Reconnect the rheostat from its new location to terminals TS11-37 and TS11-38 by using any available wire of sufficient length. On the other equipments mentioned above, connect the wire spliced to the single lead and the wire from terminal TS11-17 to the two terminals of the rheostat at its new location. In instances where the transmitter and rheostat are to be placed close together, these leads may be made part of the cable connecting the transmitter to the power supply through the hole in the top of the power unit case.

(g) For the exposed rheostat control, a suitable enclosure should be provided for protection of operating personnel from the terminals. The front of this box should be marked with an arrow in a clockwise direction to show voltage increase.

(h) The opening left in the motor-generator and rectifier power unit front panel should be closed with a cover devised from any suitable material or with the small round plate provided for this purpose. With some of the equipments, this cover is supplied in the spare parts box.

(i) Finally, replace the front panel of the power supply and proceed to operate the set with the field voltage rheostat control in its new location.

2. GENERAL.

a. Each of the units of the Navy Model TDE Series of Radio Telegraph and Telephone Transmitting Equipments, i.e., TDE, TDE-1 and TDE-2, is designed for operation on all types of Naval surface vessels or in shore stations. Due to its simplicity of design, rapid installation is facilitated for many widely varying applications.

b. As may be seen from the outline drawings and the photographs, the complete TDE equipment essentially consists of one main unit. This unit contains, within its frame, a high and low frequency transmitter and power conversion apparatus. Also provided, and mounted on the transmitter front panel, is a switch for operation of a remote control unit. To facilitate installation in limited quarters, the main transmitter and power unit may be separated into two units. In this manner, the transmitter may be placed on the operator's table and the power unit in any nearby available location.

c. The radio transmitter circuits are designed to cover the intermediate and high frequency ranges of

from 300 to 18100 kcs. The output frequency from any unit of the TDE Series equipments, is continuously variable and is obtained from two high stability self-excited master oscillators. Output circuits of the transmitter are arranged for current and voltage feed over the entire frequency range. Thus, it is feasible to work into practically any size of antenna. Also, CW, MCW and Voice modulation is provided over the entire frequency range.

d. The following table lists the frequency bands on which the Navy Model TDE Series Radio Telegraph and Telephone Transmitting Equipment operates:

	Frequency	Type of Emission
Intermediate Frequency Range	300 to 1500 kcs.	CW, MCW Telegraph and Voice Telephony
High Frequency Range	1500 to 18100 kcs.	CW, MCW Telegraph and Voice Telephony

e. On the above mentioned ranges, using properly calibrated antennas, satisfactory communication can be carried on between similar equipments or other units of the Naval communication system without the necessity of preliminary calling, and without causing interference to communication on other channels.

f. The transmitting equipment can be controlled and keyed, using either the remote control unit supplied, or the Navy standard 4- or 6-wire remote control system. For remote telephone operation, either the remote control unit supplied, or the Navy Radiophone Unit, Navy Type 23211 or 23172 may be used.

3. LIST OF EQUIPMENTS.

a. Listed below in convenient form, are all of the units in the Navy Model TDE Series Equipments. These units are designed for operation from 115 Volt D.C., 230 Volt D.C., 115/230 Volt, 1 Phase, 60 Cycle, 220/440 Volt, 3 Phase, 60 Cycle, or 208 Volt, 3 Phase, 60 Cycle A.C. power supplies. The latter equipment, supplied only on the TDE-1 contract, is furnished power through an externally connected autotransformer, Navy Type CAY-301145.

b. For Navy Model TDE Equipment, the following units are supplied:

(1) NAVY MODEL TDE, 115 VOLT D.C. OPERATION.

Qty.	Unit	Type	Height	Width	Depth	Weight
1	Radio Transmitter	CAY-52267	39-13/16	28-1/4	20-1/2	334 lbs.
1	Motor-Generator and Rectifier Power Unit	CAY-21848	22-13/16	28	19-7/16	372 lbs.
1	Remote Control Unit	CAY-23305	3-9/16	5-7/16	5-3/16	3 lbs.
1	Set of Vacuum Tubes for Installation	1-837 2-807 2-803 2-801 1-5U4G				3 oz. ea. 2-1/2 oz. ea. 10-1/2 oz. ea. 2-1/2 oz. ea. 2 oz. ea. 2-1/4 lbs.
					Total Weight	
1	Spare Parts Box # 1, containing all spares except Armatures		24-1/4	15-1/2	15-1/2	110 lbs.
1	Spare Parts Box # 2, containing spare Armature for CAY-21854 Generator		15	6-1/4	6-3/4	25 lbs.
1	Spare Parts Box # 3, containing spare Armature for CAY-21851 Motor		10	6-1/4	6-3/4	20 lbs.
	Total Weight of Equipment.....					866-1/4 lbs.

(2) NAVY MODEL TDE, 230 VOLT D.C. OPERATION

Qty.	Unit	Type	Height	Width	Depth	Weight
1	Radio Transmitter	CAY-52267	39-13/16	28-1/4	20-1/2	334 lbs.
1	Motor-Generator and Rectifier Power Unit	CAY-21849	22-13/16	28	19-7/16	372 lbs.
1	Remote Control Unit	CAY-23305	3-9/16	5-7/16	5-3/16	3 lbs.
1	Set of Vacuum Tubes for Installation	1-837 2-807 2-803 2-801 1-5U4G				3 oz. ea. 2-1/2 oz. ea. 10-1/2 oz. ea. 2-1/2 oz. ea. 2 oz. ea. 2-1/4 lbs.
					Total Weight	
1	Spare Parts Box # 1, containing all spares except Armatures		24-1/4	15-1/2	15-1/2	110 lbs.
1	Spare Parts Box # 2, containing spare Armature for CAY-21854 Generator		15	6-1/4	6-3/4	25 lbs.
1	Spare Parts Box # 3, containing spare Armature for CAY-21852 Motor		10	6-1/4	6-3/4	20 lbs.
	Total Weight of Equipment.....					866-1/4 lbs.

(3) NAVY MODEL TDE, 220/440 VOLT, 3 PHASE, 60 CYCLE OPERATION.

Qty.	Unit	Type	Height	Width	Depth	Weight
1	Radio Transmitter	CAY-52267	39-13/16	28-1/4	20-1/2	334 lbs.
1	Motor-Generator and Rectifier Power Unit	CAY-21850	22-13/16	28	19-7/16	355 lbs.
1	Remote Control Unit	CAY-23305	3-9/16	5-7/16	5-3/16	3 lbs.
1	Set of Vacuum Tubes for Installation	1-837 2-807 2-803 2-801 1-5U4G				3 oz. ea. 2-1/2 oz. ea. 10-1/2 oz. ea. 2-1/2 oz. ea. 2 oz. ea. 2-1/4 lbs.
					Total Weight	
1	Spare Parts Box # 1, containing all spares except Armatures		24-1/4	15-1/2	15-1/2	110 lbs.
1	Spare Parts Box # 2, containing spare Armature for CAY-21854 Generator		15	6-1/4	6-3/4	25 lbs.
	Total Weight of Equipment.....					829-1/4 lbs.

c. For Navy Model TDE-1, the following units are supplied:

(1) NAVY MODEL TDE-1, 115 VOLT D.C. OPERATION.

Qty.	Unit	Type	Height	Width	Depth	Weight
1	Radio Transmitter	CAY-52267A	39-13/16	28-1/4	20-1/2	334 lbs.
1	Motor-Generator and Rectifier Power Unit	CAY-21848	22-13/16	28	19-7/16	372 lbs.
1	Remote Control Unit	CAY-23381	3-11/16	5-7/16	5-1/8	3.5 lbs.
1	Set of Vacuum Tubes for Installation	1-837 2-807 2-803 2-801 1-5U4G				3 oz. ea. 2-1/2 oz. ea. 10-1/2 oz. ea. 2-1/2 oz. ea. 2 oz. ea. 2-1/4 lbs.
					Total Weight	
1	Spare Parts Box # 1, containing all spares except Armatures		24-1/4	15-1/2	15-1/2	110 lbs.
1	Spare Parts Box # 2, containing spare Armatures for CAY-21854 Generator and CAY-21851 Motor		15	6-1/4	10	45 lbs.
	Total Weight of Equipment.....					866-3/4 lbs.

(2) NAVY MODEL TDE-1, 230 VOLT D.C. OPERATION.

Qty.	Unit	Type	Height	Width	Depth	Weight
1	Radio Transmitter	CAY-52267A	39-13/16	28-1/4	20-1/2	334 lbs.
1	Motor-Generator and Rectifier Power Unit	CAY-21849	22-13/16	28	19-7/16	372 lbs.
1	Remote Control Unit	CAY-23381	3-11/16	5-7/16	5-1/8	3.5 lbs.
1	Set of Vacuum Tubes for Installation	1-837 2-807 2-803 2-801 1-5U4G				3 oz. ea. 2-1/4 oz. ea. 10-1/4 oz. ea. 2-1/2 oz. ea. 2 oz. ea. 2-1/4 lbs.
					Total Weight	
1	Spare Parts Box # 1, containing all spares except Armatures		24-1/4	15-1/2	15-1/2	110 lbs.
1	Spare Parts Box # 2, containing spare Armatures for CAY-21854 Generator and CAY-21852 Motor		15	6-1/4	10	45 lbs.
	Total Weight of Equipment.....					866-3/4 lbs.

(3) NAVY MODEL TDE-1, 220/440 VOLT, 3 PHASE, 60 CYCLE OPERATION OR 208 VOLT, 3 PHASE, 60 CYCLE OPERATION, USING EXTERNAL AUTOTRANSFORMER.

Qty.	Unit	Type	Height	Width	Depth	Weight
1	Radio Transmitter	CAY-52267A	39-13/16	28-1/4	20-1/2	334 lbs.
1	Motor-Generator and Rectifier Power Unit	CAY-21850	22-13/16	28	19-7/16	355 lbs.
1	Remote Control Unit	CAY-23381	3-11/16	5-7/16	5-1/8	3.5 lbs.
1	Set of Vacuum Tubes for Installation	1-837 2-807 2-803 2-801 1-5U4G				3 oz. ea. 2-1/2 oz. ea. 10-1/2 oz. ea. 2-1/2 oz. ea. 2 oz. ea. 2-1/4 lbs.
					Total Weight	
1	Autotransformer (used on 208 volt, 3 phase, 60 cycle installations only)	CAY-301145	3-1/8	7	5-1/2	6-1/2 lbs.
1	Spare Parts Box # 1, containing all spares except Armatures		24-1/2	15-1/2	15-1/2	110 lbs.
1	Spare Parts Box # 2, containing spare Armature for CAY-21854 Generator		15	6-1/4	6-1/4	25 lbs.
	Total Weight of Equipment.....					836-1/4 lbs.

h. NAVY MODEL TDE-1, 115/230 VOLTS, 1 PHASE, 60 CYCLE SUPPLY.

Qty.	Unit	Height	Width	Depth	Weight	Volume
1	Radio Transmitter, Motor-Generator and Rectifier Power Unit, Remote Control Unit, Complete Set of Vacuum Tubes for Installation	70	37	27	960	40.52 cu. ft.
1	Spare Parts Boxes # 1 and # 2	35	17	18	185	6.19 cu. ft.
Total Crated Weight and Volume of Equipment.....					1145 lbs.	46.71 cu. ft.

i. NAVY MODEL TDE-2, 115 VOLT D.C. SUPPLY.

Qty.	Unit	Height	Width	Depth	Weight	Volume
1	Radio Transmitter, Motor-Generator and Rectifier Power Unit, Remote Control Unit, Complete Set of Vacuum Tubes for Installation	70	37	27	960	40.52 cu. ft.
1	Spare Parts Boxes # 1 and # 2	35	17	18	205	6.19 cu. ft.
Total Crated Weight and Volume of Equipment.....					1165 lbs.	46.71 cu. ft.

j. NAVY MODEL TDE-2, 230 VOLT D.C. SUPPLY.

Qty.	Unit	Height	Width	Depth	Weight	Volume
1	Radio Transmitter, Motor-Generator and Rectifier Power Unit, Remote Control Unit, Complete Set of Vacuum Tubes for Installation	70	37	27	960	40.52 cu. ft.
1	Spare Parts Boxes # 1 and # 2	35	17	18	205	6.19 cu. ft.
Total Crated Weight and Volume of Equipment.....					1165 lbs.	46.71 cu. ft.

k. NAVY MODEL TDE-2, 220/440 VOLT, 3 PHASE, 60 CYCLE SUPPLY.

Qty.	Unit	Height	Width	Depth	Weight	Volume
1	Radio Transmitter, Motor-Generator and Rectifier Power Unit, Remote Control Unit, Complete Set of Vacuum Tubes for Installation	70	37	27	960	40.52 cu. ft.
1	Spare Parts Boxes # 1 and # 2	35	17	18	185	6.19 cu. ft.
Total Crated Weight and Volume of Equipment.....					1145 lbs.	46.71 cu. ft.

II. THEORY OF OPERATION

5. GENERAL.

a. All references to locations of parts in this equipment will be made in the following manner: The right side will mean the side which is on the observer's right and the left side the observer's left when facing the front panel of the equipment. The shelves or decks will be referred to consecutively from the bottom; that is, the first shelf is the lowest or bottom shelf.

b. Symbol designations for each unit are in a different number group. The following is a table giving the symbol for each unit:

(1) Transmitter

I. F. Components.....	101 to	199
Common Components..	201 to	299
H. F. Components.....	301 to	399
Autotransformer (for TDE-1, 208 Volt supply only).....	701 to	799
Remote Control Units...	1301 to	1399

(2) Motor-Generator and
Rectifier Power Unit.. 501 to 699

(3) Symbols for the various power supply input voltages are taken care of by different symbol designations in the 501 to 699 group. The voltages discussed in the following text, and used in the various equipments are: 115 Volt D.C., 230 Volt D.C., 220/440 Volt, 3 Phase, 60 Cycle, and 115/230 Volt, 1 Phase, 60 Cycle.

6. RADIO TRANSMITTER UNIT.

a. Essentially, the mechanical differences in the two types of transmitters, have been discussed in Par. 1.*b.* The model designation for the TDE transmitter is CAY-52267, while for the TDE-1 and TDE-2 equipments, the designation is CAY-52267A.

b. The radio transmitter unit is built into a single frame. It essentially consists of two transmitters in this assembly, which contains the necessary electrical circuits, tubes, and control apparatus for taking power from the motor-generator and rectifier power unit and delivering telegraphically keyed CW, MCW and Voice modulated radio frequency to an antenna. Nominal power output on CW is 125 watts, on MCW 35 watts, and on Voice 30 watts. On the right-hand side of the panel are grouped all controls for the intermediate frequency circuits, having a frequency range of 300 to 1500 kcs. On the left-hand side of the panel are the controls for the high frequency circuits, having a frequency range of 1500 to 18100 kcs.

c. The H.F. and I.F. circuits use separate tubes, leaving only meters and power controls common to

both circuits. In the center of the panel are grouped all controls and indicating instruments common to both circuits. Power output may be varied from full power output to approximately one-quarter of full value by means of the ANT. COUPLING control K, C-329, or S, L-109, located in each transmitter section. The transmitter is capable of handling keying speeds up to and including 100 words per minute when employing CW or MCW emission. This emission from the transmitter ceases immediately upon opening the key, as the ground return circuits to all tubes are broken by the keying relay.

d. Should it be desirous to see the general appearance and location of the components, reference must be made to Figs. 8-1 to 8-10, and 8-17 and 8-18, Dwgs. 7608991 and 7610769. All necessary operating controls are located on the front panel and are electrically "dead." Access to components inside the transmitter is made by tilting the transmitter chassis forward as it is hinged at the lower front edge. Power is removed from the unit when it is tilted forward, as there is an interlock switch which opens and removes all dangerous potentials from the equipment. Location of this interlock is as follows for the different units of the TDE equipments: For TDE, the interlock is located at the rear bottom of the transmitter case. Its position in the TDE-1 and TDE-2 equipments, is such that it will withstand a maximum amount of vibration without jarring loose. The interlock switch is located on the top rear of the transmitter.

e. The top and front panel of the transmitter unit is made so as to form two outside surfaces of the transmitter case. The remainder of the case — i.e., the bottom, sides and back — is made as a unit, into which the transmitter chassis fits.

f. Components of the transmitter are mounted on shelves which are assembled as a unit to the front panel. These shelves are supported from the top rear by two angles down the center of the unit. It will be noted that the top section of these angles are cut apart and joined with micarta to the top of the chassis. The purpose of this is to break up any circulating current paths in the frame.

g. The bottom rear of the chassis is provided with two pin catches that engage with brackets on the sides of the case. The catches may be used to hold the transmitter chassis at an angle of approximately 45° for servicing, or they may be adjusted so that they slide past the brackets. In the latter position, the transmitter can be lowered to a horizontal position and the top end supported by a detachable leg. These pins should not be pulled out too far or they may catch on the louvers when the transmitter is being pushed back into the case.

h. All component parts of the intermediate frequency range are mounted in the right-hand section and the parts of the high frequency transmitter range are mounted in the left hand section. Component parts, which are common to both circuits, are mounted in the center of the unit. One exception is the audio amplifier chassis which is mounted on the right-rear

portion of the second shelf. Nameplates for the controls which are associated with the I.F. circuit have a blue background and those which are associated with the H.F. circuit have a green background.

i. The schematic and wiring diagrams which apply to the various transmitter units of the TDE Series of equipments are as follows:

MODEL OF EQUIPMENT		FIGURE	DRAWING
TDE	Schematic Diagram	8-24	W-7300512
TDE-1/2	Schematic Diagram	8-25	W-7300540
TDE-2	Schematic Diagram	8-26	W-7300577
TDE	Wiring Diagram	8-27	W-7300501
TDE-1/2	Wiring Diagram	8-28	W-7300541
TDE-2	Wiring Diagram	8-29	W-7300578

j. For descriptive convenience, the transmitter may be broken down or divided into three distinct sections:

- (1) COMMON COMPONENTS
- (2) INTERMEDIATE FREQUENCY SECTION
- (3) HIGH FREQUENCY SECTION

k. COMMON COMPONENTS

(1) The transmitter unit consists of two separate transmitters, with certain of the necessary component common to both circuits. Most of these component are mounted on the center portion of the front panel. At the top of the unit is the gang-controlled H.F.-I.F. switch, S-213, S-214, S-215, control A. Below this switch are mounted three meters: P.A. PLATE CURRENT, M-201; P.A. GRID CURRENT, M-204; and INT. AMPL. GRID CURRENT, M-203, respectively. The control circuit controls are mounted below these meters. They are from top to bottom, ADJUST-TUNE-OPERATE switch, S-207; PLATE and FILAMENT voltmeters, M-205 and M-202, respectively; REMOTE-LOCAL switch, S-203; CW-MCW-VOICE switch, S-202; MICROPHONE jack, J-202 (built in on the TDE equipments from the conversion kit, or supplied as a regular item on the TDE-1 and TDE-2 equipments); POWER ON indicator light, I-201; START-STOP switch, S-204; and FREQUENCY METER AUDIO OUTPUT jack, J-201. (Note on the TDE-1 and TDE-2 equipments, the START-STOP switch is the lowest control in line of progression).

(2) Located to the right of the FILAMENT voltmeter, M-202, is the FILAMENT rheostat, R-201. Below this is the calibration chart. All remaining front panel controls are either in the high or intermediate frequency transmitter. There are several other components that are common to both circuits. These are the audio amplifier, located on the rear right-hand side of the second shelf, and the microphone relay and filament transformer, located on the bottom deck.

(3) Only one of the two radio frequency circuits may be used at a time. Selection of either circuit is accomplished by operation of the gang-controlled H.F.-I.F. switch S-213, S-214, S-215, control A on the front panel. When the H.F.-I.F. switch is in the H.F. position, it accomplishes the following functions.

Note

Switch section S-207B was added to the ADJUST-TUNE-OPERATE switch S-207 on the TDE-1 equipments.

On TDE-2 Equipments, a new section S-215B was added to the H.F.-I.F. switch due to change in the wiring of ADJUST-TUNE-OPERATE switch S-207A, S-207B.

(a) Plate voltage is removed from the I.F.-P.A. tube and applied to the plate of the H.F.-P.A. tube.

(b) Antenna connection is transferred from the I.F. section to the H.F. section through switch section S-213. S-213 is part of gang-controlled switch S-213, S-214, S-215, control A on the front panel.

(c) Filaments of the I.F.-P.A. tube, Navy Type 803, are turned off and the filaments of the H.F.-P.A. tube, Navy Type 803 are turned on.

(4) When the H.F.-I.F. switch is in the I.F. position, the reverse is true.

(5) In the Navy Model TDE Equipments, the ADJUST-TUNE-OPERATE switch S-207 performs the following operations:

(a) ADJUST—With the switch in the ADJUST position, the high voltage (2000 volts) is disconnected from the final amplifier. This permits adjustment, during radio silence period, of the frequency controlling circuits which are supplied voltage from the 550 volt supply.

(b) TUNE—With the switch in the TUNE position, resistor R-202 is inserted in series with the power amplifier tube plate. Thus, the plate current is limited during tuning to a safe value.

(c) OPERATE—With the switch in the OPERATE position, normal operating voltages are applied to all stages.

(6) In the Navy Model TDE-1 and TDE-2 equipments, the ADJUST-TUNE-OPERATE switch S-207A and S-207B performs the following operations:

(a) ADJUST—With the switch in the ADJUST position, the high voltage (2000 volts) is disconnected from the final amplifier, and the cathode circuit of the intermediate amplifier is opened. On some of the later TDE-2 equipments, refer to Fig. 8-26 for Serials, instead of opening the cathode circuit of the intermediate amplifier, the screen and plate circuit of the intermediate amplifier is opened. This permits adjustment, during radio silence periods, of the frequency controlling circuits which are supplied voltage from the 550 volt supply.

(b) TUNE—With the switch in the TUNE position, resistor R-202 is inserted in series with the plate of the power amplifier tube, and the cathode circuit of the intermediate amplifier is closed. On some of the later TDE-2 equipments, refer to Fig. 8-26 for Serials, instead of closing the cathode circuit of the intermediate amplifier, the screen and plate circuit of the intermediate amplifier is closed. This limits plate current of the final amplifier during tuning, to a safe value, and permits normal operation of the intermediate amplifier.

(c) OPERATE—With the switch in the OPERATE position, normal operating voltages are supplied to all stages.

(7) REMOTE-LOCAL switch S-203 transfers control of the transmitter from its front panel to any remote control station.

(8) Selection of the type of emission desired is accomplished by CW-MCW-VOICE switch S-202, which performs the following operations:

(a) CW—In this position, the suppressor grid of the power amplifier is grounded for ordinary Class C operation.

(b) MCW—In this position, the suppressor grid of the power amplifier tube is connected in series with modulation transformer T-203. Thus, the tone oscillator circuit, composed of windings in T-203, and T-202, choke L-201 and capacitor C-207, is completed.

(c) VOICE—With the switch in VOICE position, the same operations are performed, as in (b) directly above, except that the tone oscillator circuit is open circuited.

(9) Another common component of importance is the modulator unit. Modulation is accomplished by suppressor grid modulation of the power amplifier stage, through the use of a single stage audio amplifier using a Navy Type 801 tube V-201. All necessary components for the audio amplifier are located on a separate chassis which can be removed for servicing.

Microphone input transformer T-202 applies voltage to the grid of V-201 from the microphone. Tube V-201 amplifies the voltage impressed upon it. Transformer T-203 matches the output of V-201 to the suppressor of the power amplifier tube in use.

(10) The MCW circuit, composed of T-202, T-203, L-201 and C-207, is a feed-back circuit comprising a series resonant filter. It is used to produce a single frequency tone of approximately 800 cycles. Tone oscillator choke L-201 and tuning capacitor C-207 make up this filter circuit. The circuit is closed during MCW operation, and therefore produces a constant frequency modulation for the power amplifier tube in use.

(11) A momentary pushbutton type TEST key, S-208, is mounted directly behind the upper portion of the left handrail. It may be operated by thumb or finger while grasping the handrail as it extends through the handrail to provide this convenient means of operation.

I. INTERMEDIATE FREQUENCY SECTION.

(1) The intermediate frequency section, which has a frequency range of 300 to 1500 kcs., occupies the right-hand section of transmitter unit Navy Types CAY-52267 or CAY-52267A. This section is composed of a master oscillator, an intermediate amplifier, and a power amplifier. The master oscillator and intermediate amplifier are mounted on a single casting in the lower deck with the power amplifier mounted on the second deck. The audio frequency amplifier chassis is mounted on the second deck behind the power amplifier. A separate chassis is used to permit ease in servicing, as the chassis may be removed without disconnecting the unit from the rest of the transmitter circuit. An insulated shaft, terminating in a screwdriver slot on the front panel, permits adjustment of the audio gain while the equipment is in operation.

(2) Controls on the front panel for the intermediate frequency section are from bottom to top as follows: M.O. TUNING L-101, control P; M.O. RANGE S-101, control O; I.F.-P.A. RANGE S-104, control Q; P.A. TUNING L-109, control R; ANT. TUNING CAPACITOR C-131, control U; ANT. COUPLING L-109, control S; I.F. ANT. FEED S-107, control T; I.F. ANTENNA INDUCTANCE S-106, control V; and ANT. TUNING INDUCTANCE L-110, control W. Above these controls is the I.F. ANTENNA CURRENT meter M-102.

(3) The master oscillator utilizes a Navy Type 801 vacuum tube connected in a modified Colpitts oscillator circuit. The master oscillator tank circuit consists of master oscillator tuning coil L-101, master oscillator range switch S-101, and tank capacitors C-101, C-103 and C-127. Coil L-101 is of the variometer type. The master oscillator is tuned to the desired frequency by varying the inductance of L-101, M.O. TUNING control P, after the proper range has been selected by means of S-101, M.O. RANGE control O.

(4) Capacitors C-102 and C-103 divide the radio frequency voltage in the proper ratio for operation of the master oscillator tube. Capacitors C-127 and C-101 are connected in parallel with M.O. TUNING L-101, control P for certain positions of M.O. RANGE switch S-101, control O in order to obtain the proper frequency range for the oscillator.

(5) Capacitor C-104 is the grid blocking capacitor. The master oscillator grid is supplied bias by means of resistor R-102 through radio frequency choke coil L-104. Plate voltage of the oscillator tube is supplied through radio frequency choke coil L-103 from the 550 volt D.C. commutator of the generator.

(6) The intermediate amplifier uses a Navy Type 807 vacuum tube, V-102. It receives its excitation from the master oscillator circuit through variable coupling capacitor C-108. Grid bias is supplied to the intermediate amplifier tube by means of resistor R-105 through radio frequency choke coil L-105. The intermediate amplifier operates as a band-pass amplifier and requires no tuning. This band-pass circuit consists of coil L-107, chokes L-106 and L-108, and capacitor C-111. V-102 is protected against overload by cathode resistor R-112, screen resistor R-106, and plate resistor R-111. Plate voltage is supplied to the tube from the 550 volt D.C. commutator of the generator through r-f choke coil L-106. Screen voltage is supplied from this same source through a voltage dropping circuit which is composed of resistors R-106, R-107 and R-108. Capacitor C-111 acts as blocking resistance to prevent plate voltage from the intermediate amplifier being impressed upon the grid of the power amplifier stage.

(7) The power amplifier uses a Navy Type 803 vacuum tube, V-103. This tube receives its excitation from the intermediate amplifier band-pass circuit. Grid bias for the power amplifier tube is supplied by means of the bias rectifier supply through resistor R-109 and r-f choke coil L-108. The power amplifier tank circuit consists of tank coil L-109, power amplifier range switch S-104, I.F.-P.A. RANGE control Q, and tank capacitors C-121, C-122, C-123, and C-130. The power amplifier circuit is tuned over the frequency range by changing the tank capacity in the circuit and by a change of the inductance of coil L-109 through switch S-104, P.A. RANGE, control Q, and P.A. TUNING, L-109, control R. The power amplifier is inductively coupled to the antenna circuit by means of a variometer winding in tank coil L-109, controlled by ANT. COUPLING L-109, control S. Plate voltage for V-103 is obtained from the 2000 volt D.C. commutator of the generator through tank coil L-109.

(8) The antenna tuning circuit consists of ANT. TUNING INDUCTANCE L-110, control W and the ANT. INDUCTANCE switch S-106, control V. The total inductance of coil L-110 is sufficient to allow resonating of the antenna system to the lowest frequency involved.

(9) Output of the intermediate frequency section is fed to the antenna through the I.F. ANT. FEED

switch S-107, control T which is arranged for VOLTAGE or CURRENT FEED. This switch also has a third position on it, marked SERIES CAP IN which permits ANT. TUNING CAPACITOR, C-131 to be placed in series with ANT. TUNING INDUCTANCE L-110, control W.

m. HIGH FREQUENCY SECTION.

(1) Reference to Figs. 8-1, 8-2, and 8-3, show that all of the components for the high frequency transmitter are located on the left-hand side of the chassis. As in the intermediate frequency transmitter, the high frequency master oscillator circuit, the multiplier circuit and the intermediate amplifier circuit components, including the master oscillator and intermediate amplifier tubes, are all mounted on a separate casting to keep the circuits mechanically rigid. This casting is also mounted on the bottom of the transmitter chassis. Output circuits for the intermediate amplifier are mounted on the second deck along with the keying relay.

(2) The power amplifier and its associated components are mounted on the third deck. Directly above this deck, mounted on the front panel, are located the antenna circuit components.

(3) As can be seen from Figs. 8-1 and 8-2, the high frequency transmitter controls are mounted on the left side of the front panel. From bottom to top, these controls are as follows: M.O. TUNING L-301, control C; MULTIPLIER TUNING C-312, control E; M.O. RANGE S-301, control B; MULTIPLIER RANGE S-302, control D; I.A. TUNING C-320, control G; I.A. RANGE S-303, control F; ANT. COUPLING C-329, control K; P.A. TUNING L-309, control J; H.F. ANT. FEED S-304, control L; H.F.-P.A. RANGE S-307, control H; ANT. TUNING CAPACITOR C-330, control M; and ANT. TUNING INDUCTANCE L-310, control N. Above these controls is located the H.F. ANTENNA CURRENT meter M-303.

(4) The master oscillator for the high frequency transmitter section utilizes a Navy Type 837 vacuum Tube, V-301, connected in an electron coupled oscillator circuit. The tank circuit consists of coil L-301, M.O. RANGE switch S-301, control B, and tank capacitors C-302, C-303, C-304, and C-305. This oscillator operates over the frequency range from 1500 to 3000 kcs.

(5) Operation of this electron coupled oscillator circuit is essentially the same as that of a Colpitts circuit. However, there is one exception and that is the screen grid of the tube is used in the same manner as the plate would be used if a triode were employed. The screen grid and suppressor grid of tube V-301 are connected together and used as the plate for the oscillating circuit. Capacitors C-304 and C-305 act as a voltage dividing circuit in order to obtain the proper ratio of feed-back from the screen grid of the oscillator tube to the grid. This is similar to operation as obtained in the Colpitts circuit.

(6) For a tube to operate properly in a Colpitts

circuit of this type, it is necessary to keep the cathode above ground potential with respect to r-f voltage. This is done in order to be able to tap the cathode to the proper point of the voltage divider circuit formed by the capacitors C-304 and C-305, and still have a voltage developed across capacitor C-305. Because of the characteristics of the Navy Type 837 tube V-301, the voltage difference between the filament and cathode of the tube must not exceed 50 volts. To prevent this voltage difference from becoming too great, it is necessary to connect the cathode to the center of the filament by means of resistors R-303 and R-313, and capacitors C-333 and C-334, as shown on the schematic diagrams Figs. 8-24, 8-25, 8-26, Dwgs. 7300512, 7300540 and 7300577, respectively. Since the permissible voltage between filament and cathode is relatively low, it is necessary to provide a means for maintaining the cathode at a much higher voltage above ground than the allowable voltage between cathode and filament. This is done in order to impress the proper voltage across capacitor C-305. Radio frequency choke coils L-302 and L-303 are connected in series with the filament for this purpose. These chokes offer a high impedance to r-f. Thus, they keep the cathode at a high r-f potential above ground. These chokes also isolate the r-f in the cathode from the filament transformer and prevent injury to the winding.

(7) A frequency multiplying circuit, comprised of coil L-305, MULTIPLIER RANGE switch S-302, control D, and MULTIPLIER TUNING capacitor C-312, control E is connected to the plate of master oscillator tube V-301 through variable coupling capacitor C-311. This circuit operates as a frequency doubler over the frequency range of 3000 to 6000 kilocycles and as a frequency tripler over the frequency range of 6000 to 9050 kilocycles. For frequencies in the range of 1500 to 3000 kilocycles, MULTIPLIER RANGE switch S-302, control D disconnects the frequency multiplier circuit and connects the output of tube V-301 through coupling capacitor C-311 directly into plate load resistor R-301. Therefore, the plate tank circuit of the tube is operated at the same fundamental frequency as that of the screen grid circuit. Plate voltage for V-301 is obtained from the 550 volt, D.C. commutator through radio frequency choke coil L-304.

(8) The intermediate amplifier uses a Navy Type 807 vacuum tube V-302. Excitation for this tube is obtained from the multiplying circuit or from resistor R-301 through coupling capacitor C-314. Grid bias for the intermediate amplifier tube is obtained by means of bias resistor R-307.

(9) The tank circuit for intermediate amplifier tube V-302 consists of coil L-307, I.A. RANGE switch S-303, control F, and I.A. TUNING capacitor C-320. Throughout the range of 1500 to 9050 kilocycles, the intermediate amplifier stage acts as a straight through amplifier. In the range of 9050 to 18100 kilocycles, the stage operates as a frequency doubler.

(10) V-302 the intermediate amplifier tube, Navy Type 807, obtains its screen voltage from the 550 volt

D.C. commutator through resistors R-305 and R-309. Plate voltage is applied to the intermediate frequency amplifier from the 550 volt D.C. commutator through switch S-214 and coil L-307. On some of the later TDE-2 equipments, referring to Fig. 8-26, plate voltage is applied to the intermediate frequency amplifier from the 550 volt D.C. commutator through switches S-215B and S-207B and coil L-307.

(11) The power amplifier, V-303, of the high frequency section uses a Navy Type 803 vacuum tube. Excitation is obtained from the intermediate amplifier plate circuit through capacitor C-335. Grid bias for the power amplifier tube is obtained by means of grid resistor R-310 and bias rectifier, and is fed through choke coil L-308. The tank circuit for the power amplifier, consists of rotating coil L-309A, fixed coil L-309B and variable capacitor C-328.

(12) Rotating coil L-309A and variable capacitor C-328 are ganged together and driven by P.A. TUNING coil L-309, control J. In this manner, the frequency range from 2600 to 18100 kilocycles is covered without the necessity of a tank circuit tap switch. For the frequency range of 1500 to 2600 kilocycles, P.A. RANGE switch S-307, control H is used to connect coil L-309B in series with the variable coil in order to complete the frequency coverage.

(13) The antenna circuit consists of ANT. TUNING INDUCTANCE coil L-310, control N and ANT. TUNING CAPACITOR C-330, control M. In order to obtain complete coverage of the 1500 to 18100 kilocycles range, fixed coil L-310B is connected in series with variable coil L-310A for the 1500 to 2600 kilocycle range. This series connection is made by means of switch S-307B which is ganged with P.A. RANGE switch S-307, control H. The circuits are arranged for either VOLTAGE FEED or CURRENT FEED to the antenna by means of H.F. ANT. FEED switch S-304, control L. ANT. COUPLING capacitor C-329, control K is the antenna coupling capacitor and is used to vary the amount of loading in the power amplifier. It should be noted that the coupling from the power amplifier is taken from the center tap of the power amplifier tank capacitor C-328. This results in a greater reduction of harmonics than if ordinary capacity coupling were used. Also, it allows the antenna circuit to be short-circuited, open-circuited, or grounded without harmful effect to the power amplifier tube.

(14) Keying of this section is accomplished by opening the cathode and filament center taps of the tubes. This is performed in the same manner as in the I.F. section by keying relay K-202.

7. MOTOR-GENERATOR AND RECTIFIER POWER UNIT.

a. All power conversion apparatus necessary for converting available ship power to the voltages and currents needed for the operation of the transmitters covered by these instructions, is self contained in the same unit as the transmitter proper. The power equipment consists of a motor-generator set, a bias rectifier, and a Rectox unit, complete with the necessary filtering, starting and safety devices.

b. The motor-generator and rectifier power units are mechanically interchangeable with each other. The principle differences in the four units which are available, is in the input voltages. For a listing of improvements in the TDE Series Equipments to the

various units of the power supply, see Paragraphs 1.b. (1), (2) and (10). Listed below are the different complete power units available and used in the TDE equipments:

VOLTAGE SUPPLY	MODEL	POWER UNIT	MOTOR	GENERATOR
115 V. D.C.	TDE, 1, 2, 3	CAY-21848	CAY-21851	CAY-21854
230 V. D.C.	TDE, 1, 2, 3	CAY-21849	CAY-21852	CAY-21854
220/440 V., 3 Phase, 60 Cycles	TDE, 1, 2, 3	CAY-21850	CAY-21853	CAY-21854
115/230 V., 1 Phase, 60 Cycles	TDE-1 Only	CAY-211030	CAY-211031	CAY-21854

c. The frame of the power unit is made so that the front and two sides are removable. The front panel is held to the frame by four captive screws. Therefore, by simply loosening these four screws, and removing this panel, the interior of the unit may be made available for servicing. This cover also has a small door in it so that the fuses can be replaced without removing the cover.

d. Reference to Figs. 8-18 and 8-20, Dwgs. 7610769 and 7610771, show the outline and mounting dimensions of the components. In addition to the drawings Figs. 8-2, 8-3, 8-5, 8-11 and 8-12, should be seen for a more comprehensive picture of the major components of the power supply unit. From these illustrations, it should be noted that the magnetic controller is located on the left-hand side of the rectifier power unit, and the motor-generator unit is placed at the rear of the assembly. These are the main components of the power supply unit. A small auxiliary transformer, a bias rectifier to supply bias voltage, and a microphone voltage supply are also located in this unit.

e. The only control located in the power supply assembly is the main field control rheostat R-501 for the motor-generator. This control permits manual adjustment of the generator output voltage (550/2000 V. D.C.) under conditions of variation in the input line voltage of from 90 to 110% of normal. This control may be removed from the motor-generator and rectifier power unit, and located near the transmitter for installations where it is desirable to separate the transmitter from the power unit. Such a procedure will provide, for the operator, convenient control of plate voltage at or near the transmitter unit. The field rheostat is enclosed in a separate box which may be moved and relocated. To accomplish this, it is only necessary to disconnect the two field leads from the small terminal board located adjacent to the field rheostat box, remove the mounting screws which hold the rheostat assembly in place, and move the assembly to its new location. Reconnect the rheostat to the terminal board in the motor-generator unit by using any available wire which is equivalent to # 14 or

larger and insulated for 230 volts. A small plate is provided in the spare parts box which should be used to cover up the opening left in the motor-generator and rectifier unit front panel.

Note

On some of the early TDE equipments, rheostat R-501 cannot be removed to a separate location at or near the transmitter. See Par. 1 b. (1).

f. The motor-generator set is of the two-unit, four-bearing type, with motor and generator directly connected by means of a flexible coupling. The set is of drip-proof, semi-enclosed construction. Ball bearings are used throughout.

g. Ventilation of the motor-generator is provided by means of a centrifugal fan which is a part of the flexible coupling. Air is drawn in through openings in the ends of the machine and discharged through openings in the middle. Openings in the deck, and louvers in the sides and rear of the unit, allow cool air from the outside to be circulated through the motor-generator set for cooling purposes.

h. The A.C. or D.C. driving motors are of the across-the-line starting type. Motor-generator starting is accomplished by means of a Westinghouse Type DN-140 contactor which is mounted inside the front left-hand panel of the power unit. Operation of this contactor is controlled by means of pushbutton type START-STOP switch S-204 on the panel of the transmitter unit, or by means of pushbutton type START-STOP switch S-1302 (4-wire control) or S-1303 (6-wire control), on the remote control unit, depending upon the position of REMOTE-LOCAL switch S-203. On the TDE equipments, toggle type switch S-204 is used in conjunction with toggle type switch S-1301.

i. Motors, operating from D.C. power supplies, are provided with a tapped winding connected to slip rings as a source of single phase A.C. power. Their nominal output is 70% of the applied D.C. voltage, with an output frequency of approximately 60 cycles. Rated power output is 200 watts. This is sufficient power for the bias, microphone and filament supplies.

j. The generator is of the single core, double commutator type, with outputs of 2000 volts at 0.175 amps., and 550 volts at 0.26 amps.

k. The generator of the motor-generator set is self-excited from the 550 volt output circuit. Provision is made to correct changes in output voltage due to varying supply line voltage and temperature effects, by means of field rheostat R-501.

l. All ball bearings are grease lubricated. Each bearing is provided with an accessible grease cup for adding lubricant as necessary.

m. Bias voltages are supplied by an A.C. rectifying circuit which uses a Navy Type 5U4G vacuum tube, V-501, and is supplied A.C. from the slip rings of the motor on D.C. equipments or the A.C. lines on A.C. equipments. After rectification by tube V-501, the output is filtered by choke coil L-501 and capacitor C-501. A bleeder resistor, R-214, is connected across the output of the rectifier supply to provide regulation and a means of discharging the filter capacitor.

n. All filaments of the tubes in the transmitting unit are supplied from filament transformer T-201. Variable resistor R-201, in series with the supply line to the primary of this transformer, controls the filament voltage.

o. Microphone current, for use when radio telephone transmission is used, is supplied from Rectox unit RX-501. Rectifier RX-501 is mounted on the under side of the top of the power unit. This Rectox unit receives its supply through transformer T-501. Its output is sufficient to supply a microphone connected in a remote control unit or a standard Navy Radiophone unit. Output of Rectox rectifier RX-501 is filtered by chokes L-502, L-503, L-504 and capacitors C-504, C-505 and C-506. These later units are mounted by suspending them from the top of the unit.

8. REMOTE CONTROL UNIT, NAVY TYPE CAY-23305.

a. The remote control unit, Navy Model CAY-23305, is installed only on the TDE equipments. This unit is housed in a small steel box, the back of which is removable for access to the interconnection terminals. Reference to Figs. 8-13 and 8-14, shows the general appearance and position of the various controls. Fig. 8-21, Dwg. 7408403 shows the outline and mounting dimensions.

b. It will be noted that the mounting brackets may be placed on either of two positions on the sides of the unit for table top mounting or bulkhead mounting. The unit is provided with a cover that protects the controls from damage and spray.

c. The cover of the unit may be fastened to the top as there are two tapped inserts into which the captive screws may be tightened.

d. On the front panel of the remote control unit are located the toggle type START-STOP switch S-1301, POWER ON indicator light I-1301, and the three jacks, namely KEY J-1303, MIC J-1302 and PHONES J-1301. Inside the unit is located a terminal board to which all interconnections are made.

e. Remote Control Unit, Navy Type CAY-23305 may also be used with the TCE equipments. When used on the TCE, jumpers should be used across terminals #4 and #8, and #5 and #9. Reference to proper equipment interconnection diagrams should be made for more complete details.

9. REMOTE CONTROL UNIT, NAVY TYPE CAY-23381.

a. The remote control unit, Navy Model CAY-23381, designed for the TDE-1 and TDE-2 equipments, is housed in a small box made of two sections consisting of an aluminum front panel and a zinc die-cast box. On the front panel are located all of the necessary units properly wired and a terminal board mounted on spacers, to which all interconnections are made. The units mounted on the front panel fit into the zinc die-cast box and the front panel is fastened to this box by means of four screws. By removing these four screws, the front panel may be separated from the box making the units easily accessible. Reference to Fig. 8-15, shows the general appearance and position of the various controls. Fig. 8-22, Dwg. 7710645 shows the outline and mounting dimensions.

b. The cover of the remote control unit may be fastened to the top of the die-cast box as there are two tapped holes to which the captive screws may be tightened.

c. On the panel of this remote control unit, are located the START-STOP switch (S-1302 4-wire and S-1303 6-wire control), POWER ON indicator light I-1301, and the three jacks, namely KEY J-1303, MIC J-1302 and PHONES J-1301.

10. AUTOTRANSFORMER, NAVY TYPE CAY-301145.

a. The Navy Type CAY-301145 Autotransformer is used with the 220/440 Volt, 3 Phase, 60 Cycle equipments to step up the voltage from 208 volts to 220 volts. This unit is inserted between the available power source and the power unit.

b. The autotransformer is only supplied on the TDE-1 contract. When, or if needed on any installation to step up the available line voltage from 208 to 220 volts, the unit may be obtained from the contractor. Order per DL-7502448, sheet 3, line 24.

III. INSTALLATION AND INITIAL ADJUSTMENTS

11. GENERAL.

a. The installation force should become generally familiar with the Theory of Operation, Installation and Initial Adjustments, and Operation Sections of this book prior to proceeding with the installation. This instruction book has been compiled in such a manner that if carefully adhered to, it will minimize installation time and insure proper operation after installation.

b. In the unpacking and handling of the units during process of installation, care should be exercised to prevent damage to equipment. The following precautions should be observed:

(1) Keep boxes and crates containing equipment in the upright position at all times. The upright position is indicated by an arrow pointing upward, stenciled on each box or crate.

(2) Observe weights marked on boxes, crates, and units. As the larger units weigh from 250 to 1000 pounds when packed, adequate transporting and lifting gear and sufficient handling personnel should be available to prevent equipment from being subjected to unwarranted shock.

(3) Remove at least three sides from boxes or crates by removing nails with a nail puller. Do not use a hammer or pinch bar for this purpose.

c. The various units should be carefully uncrated and all wrappings removed. The shields should be removed and each compartment given a thorough inspection to determine any damage caused by shipment. The test data and instruction book, secured inside the front cover of the radio transmitter unit packing box after acceptance by the inspector, should be removed. The test data should be placed in the copy of the instruction book for use during installation.

d. Any components or wiring which may have been displaced during shipment should be replaced in their proper locations. The Navy Type CAY-52267 and CAY-52267A transmitters and the Navy Type CAY-21848, CAY-21849, CAY-21850 or CAY-211030 motor-generator and rectifier power units, depending upon the power source, are shipped properly bolted and connected together in the same shipping case. The "Lord" shockmounts, between the power unit and the transmitter unit, should be unblocked so that they permit normal operation and motion.

e. As noted in Paragraph 11.*d.*, the transmitter is shipped from the factory in one unit ready for installation. It is completely wired and adjusted for the specified voltage. Therefore, the only installation connections necessary are those for the incoming power lines, antennas, and those connections needed for the remote control units. If, however, the specified voltage is not used, the information contained in Paragraphs 13.*a.* to 13.*i.* should be followed.

f. The transmitter should be installed so that its front and sides are accessible. However, it is possible to install this transmitter with only the front accessible. This is possible, since all normal servicing may be done by removing the front plate on the power supply unit, and by tilting the transmitter out of the case. It is necessary that the unit be installed so that there is enough clearance in front of the unit to swing the transmitter down on to the leg in order to allow for any major servicing operations. The outline and mounting dimensions, as well as the recommended space required to swing the transmitter down to a horizontal position, is shown on Figs. 8-17 and 8-18 Dwgs. 7608991 and 7610769, respectively.

g. The interconnection diagrams, Figs. 8-33 through and including 8-40, Dwgs. 7709051, 7710309, 7709052, 7710308, 7709053, 7710307, 7709149 and 7710310, respectively, show the interconnection between the transmitter, the standard Navy 4- or 6-wire remote control, the remote control units Navy Types CAY-23305 and CAY-23381, and the radio telephone unit, per RE13A612A, respectively. These diagrams show type, size and insulation of wire and cable recommended for use. The proper interconnection diagram for the type of power supply (D.C. or A.C.) and control unit should be studied and carefully followed.

h. The antenna lead should be made of $\frac{3}{8}$ or $\frac{1}{2}$ inch O.D. copper tubing, and must be kept at least six inches away from all grounded objects.

i. If it is necessary for the units to operate separated from each other, it is imperative that each unit be grounded separately. Proper interconnection between the terminal strips of the units may be made by following the particular schematic and wiring diagrams for the units involved. These diagrams are as follows:

MODEL OF EQUIPMENT		FIGURE	DRAWING
TDE	Schematic Diagram	8-24	W-7300512
TDE-1/2	Schematic Diagram	8-25	W-7300540
TDE-2	Schematic Diagram	8-26	W-7300577
TDE	Wiring Diagram	8-27	W-7300501
TDE-1/2	Wiring Diagram	8-28	W-7300541
TDE-2	Wiring Diagram	8-29	W-7300578
TDE-1/2	Wiring Diagram (Power Unit)	8-30	W-7300514

12. RATING AND RANGE.

a. The radio transmitter is capable of operation at any frequency in the bands of 300 to 1500 kcs. intermediate frequency, and 1500 to 18100 kcs. high frequency. Nominal output of the unit is as follows:

EMISSION	I.F. BAND	H.F. BAND
CW	125 Watts	125 Watts
MCW	35 Watts	35 Watts
PHONE	30 Watts	30 Watts

The actual output will vary with the type and characteristics of the antenna used.

b. The Navy Model CAY-52267 or CAY-52267A Radio Transmitter Units are capable of operating with any antenna whose characteristics fall within the following limits:

300 to 1500 kcs. Range

Equivalent capacity	160 to 1000 mmfd.
Equivalent resistance	2 to 30 ohms.

1500 to 18100 kcs. Range

Equivalent capacity	500 to 1000 mmfd.
Equivalent resistance	2 to 30 ohms.

c. POWER SUPPLY LINE REQUIREMENTS.

	115 V. D.C.	230 V. D.C.	220 V. 3 Phase 60 Cy.	440 V. 3 Phase 60 Cy.	115 V. 1 Phase 60 Cy.	230 V. 1 Phase 60 Cy.
Max. Starting Power (KW)*.....	8.5 kw.	8.5 kw.	4.6 kw.	4.6 kw.	4.6 kw.	4.6 kw.
Power for Locked Key.....	1.2 kw.	1.2 kw.	1.2 kw.	1.2 kw.	1.2 kw.	1.2 kw.
Voltage Variation Permitted.....	± 10%	± 10%	± 5%	± 5%	± 5%	± 5%
Frequency Variation Permitted.....	± 5%	± 5%	± 5%	± 5%

*(Power required for starting, measured by a critically damped instrument.)

13. POWER INPUT VOLTAGE SUPPLY CHECKS.

a. When the specific voltage for which the unit was originally wired is not used, the following steps should be taken to convert the unit to the proper operating voltage.

- (1) Motor must be changed or reconnected.
- (2) Link switches must be checked for proper positions.
- (3) Indicator light resistors must be checked and replaced if not of proper value.

- (4) Starting contactor holding coil resistor must be checked for proper resistance.
- (5) Starting contactor coil must be checked for proper type.
- (6) Starting contactor heaters must be checked for proper type.
- (7) Transformer links must be checked for proper positions.
- (8) Fuses must be checked for proper rating.

b. MOTOR.

(1) The motor and generator units are held together mechanically by four tie bolts which fit into lugs on each unit spaced around the outer circumference of the unit. The inner facing ends of the frames of the two units are machined to fit. Therefore, when the two units are assembled on a level surface and drawn together by tie bolts, the shafts are aligned and no transverse bending action is present in the coupling. The coupling, which is free to slide longitudinally on the shaft, is of the flexible type and is keyed to each shaft with a Woodruff key. When the two units are locked together by means of the tie bolts, the coupling is allowed only a small amount of longitudinal movement along the shaft. However, when the units are pulled apart, the coupling will slide off the other shaft. When coupling the two units together, set the key in place and slide the coupling on the shaft. It is generally preferable to loosely bolt the two units to the bed plate before inserting the tie bolt. In this manner, the feet of the unit are in the same plane, thus obtaining horizontal alignment.

(2) In order to change the motor, it will be necessary to remove the motor-generator set from the power unit case. This can be done as follows: Remove the end shields and one of the end braces. Then, remove the four nuts which hold the motor-generator set on the shockmount. The motor-generator set and bed plate can then be lifted off the shockmount bolts and pulled out from the end where the brace was removed. The motor and generator units are each bolted to the bed plate by two bolts which may then be removed, and either one of the units removed for replacement.

(3) In converting from D.C. to A.C., from one voltage to another, or from single phase to 3 phase operation, the motor must be changed. One motor is used for both 220 or 440 volts A.C. 3 phase, 60 cycle, and another motor is used for both 115 or 230 volts A.C. single phase, 60 cycle operation. These motors have a rating of approximately 1 horsepower. For 115 volts D.C. operation, a one horsepower, cumulative compound wound motor is used. The same type motor is used on 230 volts D.C.

(4) The 115 V. D.C. motors have collector rings on one end of the armature which furnishes 200 watts A.C. at 80 volts. The 230 V. D.C. motor collector rings furnish 200 watts A.C. at 160 volts. These motors have three leads brought out for motor connection and two for connection to the slip rings. The three motor connections are marked A-1, A-2, and F-1. The leads A-1 and F-1 connect to the terminal TS 9-4 and lead A-2 connects to the terminal TS 9-3. The slip ring leads connect as follows: AC-1 to TS 9-1 and AC-2 to TS 9-2. For D.C., or single phase operation, terminal TS 9-5 is not used.

(5) The A.C. motor has a terminal board with 9 terminals mounted on the side. Terminals T-1, T-2, and T-3 are always connected to terminals TS 9-3, TS 9-4, and TS 9-5. For 3 phase, 60 cycle operation, as shown in Fig. 8-30, the terminals are connected in the following manner:

Operating Voltage	Link Connections
220 Volts	T-4 to T-5 to T-6 T-1 to T-7 T-2 to T-8 T-3 to T-9
440 Volts	T-4 to T-7 T-5 to T-8 T-6 to T-9

(6) Terminals TS 9-1 and TS 9-2 are not used for A.C. operation. The direction of rotation is marked on the generator frame. When the motor-generator set is connected for 3 phase operation and rotates in the wrong direction, the only changes necessary to correct this error is to interchange the connection of any two of the line connections from the motor terminal board to terminal strip 9. For example, connect T-2 to TS 9-5 and T-3 to TS 9-4 instead of in the order mentioned above.

(7) For 115 or 230 volts, single phase, 60 cycle, A.C. operation, a one horsepower capacitor motor is used. A terminal board is mounted on the side of the motor and the line is connected to the motor in the following manner: T-1 to TS 9-3 and T-2 to TS 9-4. Terminal TS 9-5 is not used for single phase operation. The proper link connections for operating the motor on either one of the two voltages are as follows, and is shown in Fig. 8-30.

Operating Voltage	Link Connections
115 Volts 230 Volts	T-1 to T-2 and T-3 to T-4 T-2 to T-3

c. LINK SWITCHES.

(1) The link switches, which are mounted on a terminal board in the motor-generator and rectifier

power unit provide an important feature. They are used for converting the unit for operation from a different power source from which the equipment was

connected. The correct positions for the various link switches for the available power sources, are as follows:

Link Switch	D.C.		3 Phase A.C.		Single Phase A.C.	
	115 V.	230 V.	220 V.	440 V.	115 V.	230 V.
S-502	C	C	B	B	B	B
S-503	C	C	B	B	B	B
S-504	B	B	C	C	C	C
S-505	B	C	B	B	B	B
S-506	C	B	C	C	C	C
S-507	C	C	B	B	B	B
S-508	C	C	B	B	B	B
S-509	C	B	B	B	B	B
S-510	C	B	B	B	B	B
S-511	C	C	B	B	B	B

Note

All link switches pivot on the terminal marked A. The terminals shown above are those to which the other end of the link switches are to be connected. For 230 V.D.C., use link from S-510C to S-511C, from S-508C to S-509C as shown. For all other voltages, leave these link switches open.

are of the clip-in type. For operation on 115 V. D.C., 220/440 Volts, 3 Phase A.C. and 115/230 Volts, 1 Phase A.C., R-209 should be used. For 230 V. D.C. operation, R-209 is replaced by R-215. The resistor which is removed, is to be replaced in the spare parts box, from which the new resistor was taken.

d. INDICATOR LIGHT RESISTORS.

(1) Two indicator light resistors are supplied with each equipment. The proper one is installed in the equipment for the power source specified on the motor-generator and rectifier power unit nameplate. These resistors are indicated on the schematic diagrams, Figs. 8-24, 8-25, 8-26, Dwgs. 7300512, 7300540 and 7300577, respectively as R-209 and R-215 located in the transmitter unit. These resistors

e. STARTING CONTACTOR HOLDING COIL RESISTORS.

(1) Each equipment is shipped with the proper holding coil resistor installed for the power source specified on the motor-generator and rectifier power unit nameplate. Should it be desired to convert the equipment for operation on another power source, resistors R-503, R-505, or R-506 may require replacement. These resistors are of the clip-in type and are located on the back of the motor-generator and rectifier power unit. The proper value of each resistor for each equipment and power source, is as follows:

Voltage Supply	115 V. D.C.	230 V. D.C.	220/440/3/60 A.C.	115/230/1/60 A.C.
Resistor Symbol.....	R-503	R-505	R-506	R-506
Ohms Resistance.....	500	2000	150	150

f. STARTING CONTACTOR COIL.

(1) When converting from A.C. to D.C., or to a different voltage, it is necessary to change coils K-501A, K-502A, K-503A, or K-504A in the starting contactor. Proper coils for A.C. or D.C. operation are as follows:

Voltage Supply	115 V. D.C.	230 V. D.C.	220/440/3/60 A.C.	115/230/1/60 A.C.
Coil Symbol.....	K-501A	K-502A	K-503A	K-504A
Style Number.....	1072626	944730	1040116	1040116

g. STARTING CONTACTOR HEATERS.

(1) The heater elements which are used in relays K-501, K-502, K-503, or K-504, must be checked against the following table to be absolutely positive that the correct elements are used for the power supply on hand.

Supply Voltage	115 V. D.C.	230 V. D.C.	220/3/60	440/3/60	115/1/60	230/1/60
Heater Symbol....	K-505A K-506A	K-507A K-508A	K-509A K-510A	K-509C K-510C	K-511A K-512A	K-507A K-508A
Style Number.....	966492-C	966486-C	966481-B	966474-B	966493-C	966486-C

h. TRANSFORMER LINKS.

(1) The link positions of transformers T-201, T-501, T-502, and T-503 should be checked for proper operational position against the following table:

TRANSFORMER	NAVY TYPE NO.	D.C. Power Supply		A.C. Power Supply			
		115 V. D.C.	230 V. D.C.	220/3/60	440/3/60	115/1/60	230/1/60
T-201	30928	1 to 5 2 to 6	1 to 5 2 to 6	1 to 4 3 to 6	1 to 4 3 to 6	1 to 4 3 to 6	1 to 4 3 to 6
T-501	30929	1 to 5 2 to 6	1 to 5 2 to 6	1 to 4 3 to 6	1 to 4 3 to 6	1 to 4 3 to 6	1 to 4 3 to 6
T-502	30926	1 to 3 2 to 4	2 to 3	* *	1 to 3 2 to 4
T-503	30927	1 to 3 2 to 4	1 to 3 2 to 4	2 to 3	** **	1 to 3 2 to 4

*Connect links 1 to 3 and 2 to 4. Place both secondary links 6 to 7.

**Leads normally connected to terminals 1 and 4 should be connected to terminals 5 and 8 and all links placed across 1 to 3 or 2 to 4.

i. FUSES.

(1) Fuses F-501, F-502, F-508, and F-509 should be checked for proper value against the following table:

Power Supply	115 V. D.C.	230 V. D.C.	220/440/3/60 A.C.	115/230/1/60/A.C.
Fuse Symbol.....	F-501 F-502	F-508 F-509	F-508 F-509	F-501 F-502

14. CONTROL UNITS.

a. There are a total of five different remote controls which can be used with the TDE Series Equipments. These units are as follows: (1) The Westinghouse remote control unit, Navy Type CAY-23305. This first remote control is used only on the TDE transmitter. For the TDE-1 and TDE-2 equipments, the Navy Type number is CAY-23381 for the Westinghouse remote control unit. (2) The Standard Navy 4-wire control, Navy Type 23005. (3) The Standard Navy 6-wire control, Navy Type 23146. (4) The Navy Radiophone Unit, Navy Type 23172. (5) The

Navy Radiophone Unit, Navy Type 23211. All equipments are shipped connected for operation with remote control unit, Navy Type CAY-23305 or CAY-23381, depending upon the model of equipment. If it is desired to use any of the other remote control units, reference should be made to the proper interconnection diagrams, Figs. 8-35, 8-36, 8-37, 8-38, 8-39, 8-40, Dwgs. 7709052, 7710308, 7709053, 7710307, 7709149 and 7710310, respectively. In addition to these interconnecting diagrams, link switches S-209, S-210, S-211 and S-212 must be checked with the following table for correct position.

LINK SWITCH	TYPE OF REMOTE CONTROL				
	4-WIRE		6-WIRE	WESTINGHOUSE	
	D.C.	A.C.		4-WIRE	6-WIRE
S-209	C	B	B	B	B
S-210	C	C	B	C	B
S-211	F	E	E	E	E
S-212	B	C	C	C	C
TS12-2 to TS12-4	Open	Open	Closed	Open	Closed

Note

Bias keying is used when 4-wire control is employed for A.C. operations. All link switches pivot on the terminal A or D. The terminals listed above are the proper ones for connection to the other end of the link switches. The Navy Radiophone Unit, Navy Type 23172 uses the 4-wire data, while the Navy Type 23211 uses the 6-wire data in the above table.

b. Radiophone Unit, Navy Type 23172, a 4-wire control, may be utilized simultaneously with the Westinghouse control unit, Navy Type CAY-23305 for TDE or CAY-23381 for TDE-1 and TDE-2 transmitting equipments. The proper interconnection diagram, Fig. 8-39, Dwg. 7709149 should be followed for connecting the Radiophone Unit to the CAY-23305 remote control unit. Also, for connecting the additional leads from the transmitter to the CAY-23305 4-wire control, refer to Fig. 8-33, Dwg. 7709051. When using the Radiophone Unit in conjunction with control unit, Navy Type CAY-23381, make connections in accordance with Fig. 8-40, Dwg. 7710310. For connecting the additional leads from the transmitter to the CAY-23381 control unit, refer to Fig. 8-34, Dwg. 7710309.

c. Radiophone Unit, Navy Type 23211, a 6-wire control, may be used simultaneously with the Westinghouse control unit, Navy Type CAY-23305 for TDE or CAY-23381 for TDE-1 and TDE-2 transmitting equipments. The proper interconnection diagram, Fig. 8-39, Dwg. 7709149 should be followed for connecting the Radiophone Unit to the CAY-23305 remote control unit. Also, for connecting the additional leads from the transmitter to the CAY-23305 4-wire control, refer to Fig. 8-33, Dwg. 7709051. See CAUTION notice, which follows this paragraph, for exceptions. When using the Radiophone Unit in conjunction with control unit, Navy Type CAY-23381, make connections in accordance with Fig. 8-40, Dwg. 7710310. For connecting the additional leads from the transmitter to the CAY-23381 control unit, refer to Fig. 8-34, Dwg. 7710309.

CAUTION

Do not connect leads from terminals 1 and 2 at the transmitter to terminals 1 and 2 at

the remote control unit, Navy Type CAY-23305. Instead, connect leads 1, 2, and 3 to a standard pushbutton station located near the remote control unit as shown in the accompanying diagram. This pushbutton station must be of the momentary start-stop type and may be of the type which mounts on the conduit leading up to the remote unit so that no special enclosure or mounting need be added other than the standard conduit switch box. This switch box is not supplied by Westinghouse.

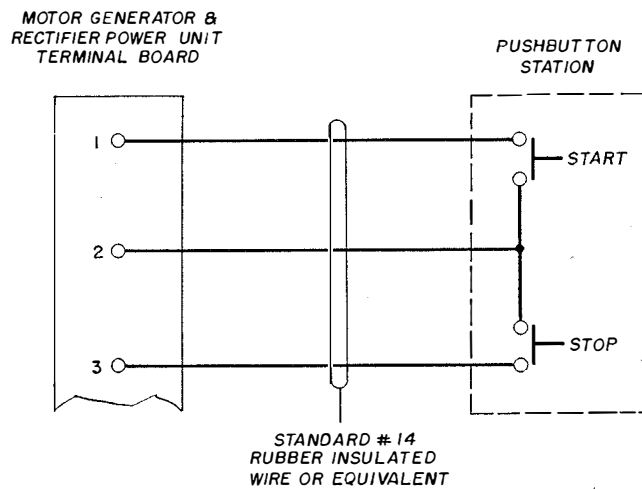

6-Wire Control Through External Pushbutton Station
CAY-23305 Remote Control Unit

d. On TDE installations, the transmitter can then be started and stopped by means of this pushbutton station, and keyed or modulated through the use of Navy Type CAY-23305 remote control unit. The start-stop switch in the remote control unit will be unused in this condition. It will also be necessary to change the output connection of the Navy Radiophone Unit, Type 23211 to transformer T-201 from the normal 600 ohm output to the 200 ohm tap. The transmitter microphone transformer T-202, shown on the schematic diagram, Fig. 8-24, Dwg. 7300512, should be connected as explained in Par. 14. e.

e. One additional change is required when the Radiophone Unit, Navy Type 23172 or 23211 is used. Audio input transformer T-202 has a tapped primary

to match either a 200 ohm or a 600 ohm impedance input. If a Westinghouse remote control unit, Navy Type CAY-23305 or CAY-23381 is used, the input impedance to the transformer should be 200 ohms. The input leads should be connected to terminals 1 and 7 on this transformer. If a Navy Type 23172 or 23211 Radiophone Unit is used, the input impedance to the transformer will be 600 ohms and it will be necessary to connect the input leads to terminals 1 and 2 of the transformer. In order to change from one type of input to the other, it is necessary to remove the audio chassis from the transmitter and reconnect the soldered input leads at the transformer. Care should be taken not to hold the soldering iron on these transformer terminals too long, as to do so may destroy the hermetical seal.

f. All link switches must be in their proper positions before power is applied to the equipment. *On D.C. equipments utilizing 4-wire control system, link switch S-504 should never be connected A to C, and link switch S-211 should never be connected D to E. The main power line will become grounded unless this precaution is taken.*

g. All wiring between units should be in armored or lead-covered cable. The recommended Navy type cables to be used are indicated on the proper inter-connection diagrams.

h. The transmitter case and motor-generator and rectifier power unit case, if separated, should be securely grounded to the hull by a copper strap at least one inch wide by 1/32 inch thick.

i. It is recommended that 3/8 or 1/2 inch copper tubing be used for the transmitting antenna lead. This lead should be kept *at least 6 inches* away from

all grounded objects. The receiver lead should be kept *at least 6 inches* from the incoming transmitting lead and should preferably be copper tubing of a smaller size than the transmitting antenna lead.

j. After completing the installation, and before applying power to the transmitter, carefully check over the units to see that all the circuits are complete according to diagrams and that there are no loose connections.

15. CHECKING.

WARNING

Operation of this equipment involves the use of high voltages (3000 volts), which are dangerous to life. Operating personnel must at all times observe all safety regulations. Do not change tubes or make adjustments inside the equipment with the high voltage supply on. Do not depend upon door interlocks or switches for protection, but always shut down the motor-generator or other power equipment and open the main switch in the supply line.

a. Before actual tuning or operation of the equipment is attempted, the following check tests should be completed. These tests are divided into three parts.

(1) POWER EQUIPMENT AND CONTROL CIRCUIT TESTS.

(2) PRELIMINARY TRANSMITTER OPERATION TESTS.

(3) REMOTE CONTROL UNIT TESTS.

b. POWER EQUIPMENT AND CONTROL CIRCUIT TESTS.

(1) For a quick reference, before operation is planned, Figs. 8-2 and 8-3 should be noted. Also, as a further check, reference should be made to the following wiring and schematic diagrams:

MODEL OF EQUIPMENT		FIGURE	DRAWING
TDE	Schematic Diagram	8-24	7300512
TDE-1/2	Schematic Diagram	8-25	7300540
TDE-2	Schematic Diagram	8-26	7300577
TDE	Wiring Diagram	8-27	7300501
TDE-1/2	Wiring Diagram	8-28	7300541
TDE-2	Wiring Diagram	8-29	7300578
TDE-1/2	Wiring Diagram, Power Unit	8-30	7300514
TDE	Wiring Diagram, Remote Control	8-31	7708883
TDE-1/2	Wiring Diagram, Remote Control	8-32	7710408

(2) The wiring diagrams show each part in its approximate position in the equipment and the schematic diagrams show the elements of the parts as they appear in the circuits.

(3) Throughout the discussion on OPERATION, all symbol numbers which apply to a circuit part are listed following the name of that part. Therefore, it should be kept in mind that wherever more than one symbol number follows the name of a part, only one of the symbol numbers apply to the equipment under discussion. The proper symbol which applies is easily determined by referring to the wiring or schematic diagrams and the parts list for the particular equipment.

(4) Schematically, the circuits for all the power supplies are fundamentally identical. Therefore, the following description of operation applies equally well for any one of the equipments and power supplies. Parts which serve the same purpose in each of the types of equipments and are identical, are assigned the same symbol number. However, parts which serve the same purpose but have a different rating due to difference in voltage to equipment, are assigned other symbol designations.

(5) With no tubes in the transmitter or power unit, and with the tube plate leads hanging in the clear, set the controls as follows:

(a) Remove the front cover of the motor-generator and rectifier power unit and open the cover of contactor K-501, K-502, K-503, or K-504. Check the connections and movement of this contactor to insure that all connections are tight and it is free to operate normally.

(b) Check the ten link switches in the motor-generator and rectifier power unit, namely S-502, S-503, S-504, S-505, S-506, S-507, S-508, S-509, S-510, and S-511, to see that they are connected properly for the voltages and type of current which is to be used with the particular equipment being installed.

(c) Check incoming line fuses F-501, F-502, F-508, and F-509 on the bottom deck at the left-hand side of the unit for good connection and contact. Also, check all fuses on the fuse panel in the front of the power unit. Replace the front cover of the power unit and secure it firmly.

(d) Open the transmitter and check link switches S-209, S-210, S-211, and S-212 for proper connections and type of control to be used with the particular equipment being installed. Close the transmitter and lock.

(e) Turn FILAMENT VOLTAGE control R-201 and PLATE VOLTAGE control R-501 to the maximum counter-clockwise position (all resistance in).

(f) Set local START-STOP switch S-204 to STOP position.

(g) Set REMOTE-LOCAL switch S-203 to LOCAL position.

(h) Set PHONE-CW-MCW switch S-202 to CW position.

(6) With a "dead" supply line, connect this line to input terminals 34, 35 and 36. Apply power. Use an external voltmeter to check the line voltage at the input terminals in the contactor. Line voltage should be practically normal for these preliminary checks.

(7) With the incoming line connected and the motor-generator and rectifier power unit properly grounded, place START-STOP switch S-204 in START position. This should start the motor-generator set which will build up and indicate approximately 1800 volts on PLATE VOLTMETER M-205 and 7 volts on FILAMENT VOLTMETER M-202.

(8) Check operation of control switch interlocks in the following manner:

(a) Rotate the handle of the door leading to the fuse compartment in a counterclockwise direction in order to open the door.

(b) Be careful not to come in contact with any of the fuses or holders within the unit. When this door is open, it should immediately cause the motor-generator set to stop by opening the line to contactor K-501, K-502, K-503 or K-504. Close and lock the fuse door.

(c) Unscrew the locking screws at the top of the transmitter panel. Tilt the transmitter unit forward a few inches out of the case, being careful to hold only the hand rails during this operation. This causes the motor-generator set to stop by opening the line to contactor K-501, K-502, K-503 or K-504. Put the transmitter unit back into its place and tighten the locking screws.

(9) Operate TEST key S-208. This should cause keying relay K-202 to function.

(10) Transfer REMOTE-LOCAL switch S-203 to the REMOTE position. Place local START-STOP switch S-204 to the STOP position. In the case of a 4-wire remote control system, or remote control unit, Navy Types CAY-23305 or CAY-23381, the radio transmitter and motor-generator units should shut down. With the local START-STOP switch S-204 transferred to the START position, start the motor-generator by placing START-STOP switch of the Type 23005, 4-wire, Navy standard remote control unit, or Westinghouse remote control unit, installed on the operator's desk, to ON or START. In this manner, the motor-generator and radio transmitter unit should start. Close the telegraph key connected to the 4-wire remote control unit or remote control unit, Navy Type CAY-23305. Operation of keying relay K-202 should be the same as operating TEST key S-208.

(11) In the case of a 6-wire remote control system, the equipment will continue to run regardless of the operation of REMOTE-LOCAL switch S-203. When S-203 is changed to the REMOTE position, operation of the remote key should operate keying relay K-202. The equipment should START and STOP switch S-204 is placed in the STOP position. However, if local START-STOP switch S-204 is in the STOP position, when REMOTE-LOCAL switch S-203 is in the REMOTE position, the motor-generator set will not start when the START-STOP switch on any of the remote control units is placed in the START position. Also, when REMOTE-LOCAL switch S-203 is in the REMOTE position, the motor-generator unit should immediately stop if START-STOP switch S-204 is placed in the STOP position, regardless of the position of the START-STOP switch on any of the remote control units.

(12) Shut down the motor-generator and radio transmitter unit by placing local START-STOP switch S-204 on the radio transmitter to STOP.

c. PRELIMINARY TRANSMITTER OPERATION TESTS.

(1) In conducting the following preliminary installation tests, have at hand a copy of the Routine Test Data or Typical Type Test Data. This test data contains the exact dial and control settings for the various frequencies from 300 to 1500 kcs. and 1500 to 18100 kcs. taken on this particular transmitter unit during Navy Acceptance tests at the manufacturer's plant. Although in service, the frequencies desired will not be the same as those shown on the Test Data, by interpolation the approximate dial and control settings can be obtained. By carefully following this Test Data, it will be possible to select the correct harmonic of each tuned circuit and avoid the possibility of tuning to a harmonic of a previous stage when the fundamental was desired, or vice versa. Approximate calibration curves are given in Figs. 8-42 to 8-46. Dial settings and typical meter readings are given in Figs. 8-52 and 8-53. Various tuning controls are identified by letters as marked on the panel, followed by symbol designations as used on schematic diagrams, Figs. 8-24, 8-25, and 8-26, Dwgs. 7300512, 7300540 and 7300577, respectively.

d. APPLICATION OF FILAMENT POWER TO ALL TUBES.

- (1) Place all tubes in their proper sockets in the transmitter and make all grid and plate connections.
- (2) Secure all shields on the transmitter, motor-generator and rectifier power unit, and remote control

unit. Failure to secure shielding in a positive manner, may adversely affect performance of the equipment.

(3) With generator field rheostat R-501 adjusted for minimum voltage, start the power unit by placing REMOTE-LOCAL switch S-203 to LOCAL and local START-STOP switch S-204 to START. Furthermore, adjust FILAMENT VOLTAGE rheostat R-201 until FILAMENT VOLTAGE meter M-202 indicates a value of exactly 10 volts.

(4) Place the gang-controlled H.F.-I.F. switch S-213, S-214, S-215, control A on the TDE and TDE-1 equipments in the H.F. position. For TDE-2 equipments, the H.F.-I.F. switch, control A on the front panel, is comprised of switch sections S-213, S-214, S-215A and S-215B. With control A in the H.F. position, all tube filaments should light with the exception of the intermediate frequency power amplifier tube V-103. This tube is located in the upper right-hand section of the transmitter unit. With control A in the I.F. position, the intermediate frequency power amplifier tube should have its filament lighted and the filament of the high frequency power amplifier tube V-303 should go out.

(5) Place the ADJUST-TUNE-OPERATE switch S-207 in the ADJUST position.

Note

On the TDE-1 and TDE-2 Equipments, due to circuit changes made necessary by the inclusion of this switch in the screen and plate circuits of the Intermediate Amplifier, another section was added to S-207 making the switch S-207A and S-207B.

e. SETTING OF POWER AND TUNING CONTROLS FOR H.F.

(1) It will be noted that once the gang-controlled switch S-213, S-214, S-215, control A is set to the proper position, all tuning operations are carried out in a logical manner by setting the controls in alphabetical order.

(2) With the motor-generator stopped, make the following settings: Set the H.F.-I.F. switches S-213, S-214, S-215, control A in the H.F. position. Set the REMOTE-LOCAL switch S-203 in the LOCAL position. Then, set the ADJUST-TUNE-OPERATE switch S-207 to the ADJUST position.

(3) Regulate all of the high frequency range and tuning controls for an output frequency of approximately 5000 kcs., as follows:

CONTROL		POSITION
H.F.-I.F.—(S-213, S-214, S-215)	A	H.F.
M.O. RANGE—(S-301)	B	4
M.O. TUNING—(L-301)	C	370
MULTIPLIER RANGE—(S-302)	D	3
MULTIPLIER TUNING—(C-312)	E	39
I.A. RANGE—(S-303)	F	3
I.A. TUNING—(C-320)	G	64
P.A. RANGE—(S-307)	H	2.6-18.1 mcs.
P.A. TUNING—(L-309)	J
ANT. COUPLING—(C-329)	K	0
ANT. FEED—(S-304)	L	DEPENDS ON ANTENNA
ANT. TUNING CAPACITOR—(C-330)	M	DEPENDS ON ANTENNA
ANT. TUNING INDUCTANCE—(L-310)	N	DEPENDS ON ANTENNA

f. APPLICATION OF PLATE AND SCREEN POTENTIAL TO TUBES AND H.F. TUNING ADJUSTMENTS.

WARNING

Before keying, allow approximately 40 seconds after filaments are turned on in order to permit these filaments to come to their proper operating temperature.

(1) Start the motor-generator unit by placing START-STOP switch S-204 in the START position. After the motor-generator set is up to speed, adjust FILAMENT VOLTAGE rheostat R-201 until FILAMENT VOLTAGE meter M-202 indicates 10 volts. Regulate PLATE VOLTAGE rheostat R-501 until PLATE VOLTAGE meter M-205 indicates approximately 2000 volts. Press TEST key S-208. If any of the maximum current values noted below are exceeded, the transmitter unit is not operating correctly. In order to correct this and obtain proper operating current, reference should be made to Par. 18. *a.* for more complete information.

(a) Adjust H.F. MULTIPLIER TUNING capacitor C-312, control E for maximum int. ampl. grid current on meter M-203. The reading should be approximately 2 ma. and must not exceed 5 ma.

(b) Adjust H.F. I.A. TUNING capacitor C-320, control G for maximum P.A. GRID CURRENT on meter M-204, approximately 30 ma. but not in excess of 50 ma.

(c) Release TEST key S-208, and set ADJUST-TUNE-OPERATE switch S-207 to the TUNE position. Make certain that the H.F. ANT. COUPLING control K is set to 0.

(d) Adjust H.F. P.A. TUNING coil L-309, control J for a minimum power amplifier plate current reading on meter M-201. It will be approximately 50 ma. but should not exceed 150 ma. The direct reading dial for H.F. P.A. TUNING coil L-309, con-

trol J will indicate the approximate setting for this dial.

(e) Refer to Fig. 8-49, Dwg. 7709570 for H.F. antenna tuning data. With a known length of antenna, and any given frequency in the 1500 to 18100 kcs. range, the type of feed (position of ANT. FEED switch S-304, control L) can be determined. For instance, if a 100 foot antenna is being used, and the output frequency of the transmitter is 5 megacycles, set ANT. FEED switch S-304, control L in the VOLTAGE feed position. Increase coupling slightly by rotating ANT. COUPLING capacitor C-329, control K in a clockwise direction. Adjust H.F. ANT. TUNING CAPACITOR C-330, control M and H.F. ANT. TUNING INDUCTANCE L-310, control N until maximum output, as indicated on H.F. ANTENNA CURRENT meter M-303, is obtained.

(f) In the 1500 to 2600 kilocycle range, H.F. P.A. RANGE switch S-307, control H has four positions. In position 1, fixed inductance L-310B is completely in the antenna circuit. Tap 2 shorts out a portion of L-310B. Tap 3 shorts out still more of L-310B. Tap 4 shorts out all of L-310B. H.F. ANT. TUNING INDUCTANCE L-310, control N has sufficient range to overlap the above mentioned taps. In this manner, all normal antennas may be resonated.

(g) If the reading on the P.A. PLATE CURRENT meter M-201 exceeds 150 ma., reduce H.F. ANT. COUPLING capacitor C-329, control K. It may be necessary to retune P.A. TUNING coil L-309, control J after the antenna has been tuned up. Readjust P.A. TUNING coil L-309, control J; ANT. TUNING CAPACITOR C-330, control M and ANT. TUNING INDUCTANCE, L-310, control N simultaneously, until an optimum condition of resonance exists. It will be generally found that maximum output is obtained when the ANT. TUNING CAPACITOR C-330 is set at the minimum value (highest dial reading on control M) possible, and still able to tune the antenna. This is the true value on either CURRENT or VOLTAGE feed on the H.F. band.

(b) In order to resonate the antenna, it may be necessary to try various combinations of H.F. ANT. TUNING CAPACITOR C-330, control M and ANT. TUNING INDUCTANCE L-310 control N, also VOLTAGE or CURRENT feed to the antenna.

(2) Operate TEST key S-208 a few times and note that each time the key is opened, the current falls to zero on all current meters.

(3) The high frequency circuits are now ready for final tuning and operation into an antenna at any frequency throughout its frequency range.

(4) By referring to the proper schematic diagram, it will be noted that for the frequency range of 1500 to 3000 kcs., the master oscillator tube loads into plate loading resistor R-301 instead of into the multiplier resonant circuit. Throughout this frequency range of 1500 to 3000 kcs., H.F. MULTIPLIER TUNING capacitor C-312, control E has no function in the circuit. Therefore, the intermediate amplifier tube acts as a class A amplifier, and draws negligible

grid current. This is indicated by INT. AMPL. GRID CURRENT meter M-203 as less than 0.5 ma. Tuning throughout this range will be accomplished as above, except that the tuning operations will not include tuning the H.F. MULTIPLIER TUNING capacitor C-312, control E.

g. SETTING OF POWER AND TUNING CONTROLS FOR I.F.

(1) Tuning of the intermediate frequency section of the transmitter is carried out in a manner similar to that used in tuning the high frequency section.

(2) With the motor-generator set stopped, make the following settings: Set the gang-controlled H.F.-I.F. switch S-213, S-214, S-215, control A to the I.F. position, and position the ADJUST-TUNE-OPERATE switch S-207 to the ADJUST position. Regulate the REMOTE-LOCAL switch S-203 to the LOCAL position.

(3) Set all I.F. range and tuning controls for an output frequency of 300 kcs. by means of the following tabulation:

CONTROL		POSITION
H.F.-I.F.—(S-213, S-214, S-215)	A	I.F.
M.O. RANGE—(S-101)	O	1
M.O. TUNING—(L-101)	P	187
P.A. RANGE—(S-104)	Q	1
P.A. TUNING—(L-109)	R
ANT. COUPLING—(L-109)	S
ANT. FEED—(S-107)	T	DEPENDS ON ANTENNA
ANT. TUNING CAPACITOR—(C-131)	U	DEPENDS ON ANTENNA
ANTENNA INDUCTANCE—(S-106)	V	DEPENDS ON ANTENNA
ANT. TUNING INDUCTANCE—(L-110)	W	DEPENDS ON ANTENNA

h. APPLICATION OF PLATE AND SCREEN POTENTIAL TO TUBES AND I.F. TUNING ADJUSTMENTS.

WARNING

Allow approximately 40 seconds after filaments are turned on before keying. This permits the tube filaments to come up to operating temperature.

(1) Start the motor-generator by placing the local START-STOP switch S-204 in the START position. After it is up to speed, regulate FILAMENT VOLTAGE rheostat R-201 until FILAMENT VOLTAGE meter M-202 indicates 10 volts. Adjust PLATE VOLTAGE rheostat R-501 until PLATE VOLTAGE meter M-205 indicates approximately 2000 volts. When tuning the intermediate frequency section of the transmitter unit, do not exceed the current values read on the various meters, given as maximum values in the following paragraph.

(a) When TEST key S-208 is pressed, the INT. AMPL. GRID CURRENT meter M-203 should read approximately 2 ma. and not in excess of 5 ma. P.A. GRID CURRENT meter M-204 will read approximately 30 ma. and should not exceed 50 ma.

(b) Release TEST key S-208, and place ADJUST-TUNE-OPERATE switch S-207 in the TUNE position. Make certain the ANT. COUPLING coil L-109, control S is set to 0 and adjust the I.F. P.A. TUNING coil L-109, control R for minimum P.A. PLATE CURRENT on meter M-201, which should be approximately 50 ma. but not in excess of 150 ma.

Note

Under certain I.F. antenna conditions, where the characteristics exceed the antenna limits for which the equipment was designed, excessive r-f potentials may be developed. In such cases, reduce ANT. COUPLING coil L-109, control S so that the power amplifier plate current is reduced to 150 ma. when operating on VOLTAGE feed position of ANT. FEED switch S-107 control T below 400 kcs. Refer to Fig. 8-48.

(c) Once P.A. TUNING coil L-109, control R is set for a minimum value as indicated on P.A. PLATE CURRENT meter M-201, this control should be locked and should not be retuned while antenna adjustments are being made. In the I.F. section of the transmitter unit, tuning of the antenna system does

not affect tuning of the intermediate frequency power amplifier.

(d) Increase antenna coupling through I.F. ANT. COUPLING coil L-109, control S. Refer to antenna curve Fig. 8-48, Dwg. 7709571 for approximate I.F. antenna tuning data. With a known length of antenna, and any given frequency in the 300 to 1500 kilocycle range, the type of feed (position of ANT. FEED switch S-107, control T) can be determined from this curve. As an example, for a 375 foot antenna at 300 kcs., set ANT. FEED switch S-107, control T in the CURRENT feed position. Adjust I.F. ANT. TUNING INDUCTANCE coil L-110, control W and I.F. ANT. TUNING CAPACITOR C-131, control U, for VOLTAGE or SERIES CAP IN position only, until maximum antenna current, as indicated on I.F. ANTENNA CURRENT meter M-102, is obtained. With the antenna circuit tuned, note antenna current obtained. If the value is greater than 10 amperes, a careful check should be made on ammeter shunting, as covered by Par. 19 c. (5).

(2) Operate TEST key S-208 a few times. Note that each time it is opened, current falls to zero on all meters. The I.F. transmitter is now in working order and ready for final tuning and operation at any frequency throughout its range.

i. REMOTE CONTROL UNIT TESTS.

(1) Place REMOTE-LOCAL switch S-203 on the transmitter unit in the REMOTE position. Regulate the remote control unit START-STOP switch to the STOP position and set the local START-STOP switch S-204 in the START position. Place CW-MCW-VOICE switch S-202 in the CW position, and position TEST key S-208 so that it is open. Make certain that all doors and panels are properly closed on the transmitter and power supply units so that all interlock switches are properly closed.

(2) Conduct the following tests with a Remote Control Unit, Navy Type CAY-23305 (for TDE) or CAY-23381 (for TDE-1 and TDE-2) used in conjunction with the equipment.

(a) On the TDE equipments only, place the START-STOP switch S-1301 in the START position. This should cause the motor-generator set to start and apply filament and plate voltage to the transmitter. The indicator light I-1301 on the remote control unit should light.

(b) For TDE-1 and TDE-2 equipments, place the remote START-STOP switch S-1302 or S-1303, depending on whether Westinghouse 4- or 6-wire control is used, in the START position. This should cause the motor-generator set to start and apply plate and filament voltage to the transmitter unit. As in the case of the remote control unit for the TDE equipments, indicator light I-1301 should light.

Note

The remaining three operations, as outlined in Pars. 15. i. (2) (c), (d) and (e) are identical for all equipments.

(c) Plug the remote key into KEY jack J-1303. Operation of the remote key should cause keying relay K-202 to function and key the transmitter.

(d) Place CW-MCW-VOICE switch S-202 in the MCW position. Operation of the remote key should again cause keying relay K-202 to function and key the transmitter. Normal MCW operation is indicated on the meters on the front panel of the transmitter.

(e) Transfer CW-MCW-VOICE switch S-202 to VOICE position. Plug the microphone into MIC jack J-1302 in the remote control unit. Operate the Press-to-Talk button on the microphone. This should cause keying relay K-202 to close and provide carrier emission. With the microphone approximately 1 inch from the mouth, speak with a normal voice into the microphone. This will apply modulation to the transmitter. Listen to the output of the transmitter on a local receiver. While the transmitter is being modulated, the modulation should be clear and strong. Modulation input to the transmitter may be adjusted to the proper value by means of the screwdriver adjustment on the front panel of the transmitter. This adjustment potentiometer R-206 is marked AUDIO-GAIN. Normal operation of the transmitter unit on VOICE operation will be indicated on P.A. PLATE CURRENT meter M-201 and the ANTENNA CURRENT meter M-102 or M-303. Power amplifier plate current will be approximately 60 per cent of the value that it is on CW operation. Furthermore, the power output will be approximately 25 per cent of normal CW output for the same setting.

(3) If a Navy Standard 4- or 6-wire control is used in connection with the TDE Series of equipments, the same test as described in Par. 15. i. (2) should be conducted in order to insure proper operation. When a Navy Standard 6-wire control is used, throwing REMOTE-LOCAL switch S-203 from LOCAL to REMOTE when local START-STOP switch S-204 is in the START position will not cause the generator to stop. This is because the START button on the Navy Standard 6-wire control is of the momentary contact type.

(4) For operation in connection with the remote telephone Navy Radiophone unit per Navy Specification RE-13A-612A, the same test should be conducted as outlined in Par. 15. i. (2). If this remote control radio telephone unit is used, one indicator light on the panel of the remote control unit should indicate when the motor-generator set is running. The other indicator light will indicate when the push button on the microphone has been closed, which causes carrier emission from the transmitter unit. A check should be made to insure proper connection on transformer T-202, see Par. 14. e.

(5) The equipment is now ready for final tuning and calibration on the frequency on which it is desired to operate. Final tuning should be performed exactly as explained in Section IV. OPERATION.

IV. OPERATION

WARNING

Operation of this equipment involves the use of high voltages (3000 volts) which are dangerous to life. Operating personnel must at all times observe all safety regulations. Do not change tubes or make adjustments inside equipment with high voltage supply on. Do not depend upon door switches or interlocks for protection, but always shut down motor-generator or other power equipment and open main switch in supply line to equipment. Interlocks are provided on normal access doors only. Always ground internal units or circuits prior to touching them. Under certain conditions, dangerous potentials may exist in circuits after shutdown due to charges retained by capacitors. All necessary precautions should be observed to prevent injury to personnel.

16. OVERLOAD PROTECTION.

a. Overload protection for the equipments is provided by means of fuses mounted in the motor-generator and rectifier power unit, and thermal overload contacts mounted in the contactor K-501, K-502, K-503, or K-504. The fuses provided for overload protection are connected in the same manner in both D.C. and A.C. equipment. This is shown in the schematic diagrams Figs. 8-24, 8-25, and 8-26, Dwgs. 7300512, 7300540, and 7300577. The incoming power line is connected to contactor K-501, K-502, K-503 or K-504 through line fuses F-501 and F-502, or F-508 and F-509. These fuses are mounted on the deck of the motor-generator and rectifier power unit on the left-hand side. Thermal characteristics of overload contactor K-501, K-502, K-503 or K-504 are such that on short-circuit overloads, there is sufficient time delay. Therefore, the contacts will not be required to open short-circuit currents, but rather the fuses F-501, and F-502 or F-508, and F-509 will blow. The thermal overload contacts are of the hand-reset type and may be reset by pushing the red button located on the contactor box.

b. All other fuses used for overload protection are located on the deck in the front center of the motor-generator and rectifier power unit. Fuses F-504 and F-505 are connected in series with the primary winding of filament transformer T-201 and rectifier power transformer T-501. These fuses provide protection for the transformers. In the case of D.C. equipments, they also provide protection for the A.C. winding on the motor. In addition to these fuses, F-503 is in series with one side of the primary of rectifier power transformer T-501.

c. The high voltage D.C. circuits are protected against overload by fuses located on the deck in the front center of the motor-generator and rectifier

power unit. Fuse F-506 is connected in series with the positive lead from the 2000 volt commutator, and fuse F-507 is connected in series with the positive lead from the 550 volt commutator.

17. TUNING PROCEDURES.

a. GENERAL.

(1) The transmitting equipment may be started and stopped by means of START-STOP switch S-204. Local control is always supervisory, since the remote control can be interrupted by means of REMOTE-LOCAL switch S-203 on the transmitter unit.

(2) Typical dial settings and meter readings for various frequencies throughout the H.F. and I.F. ranges of the transmitter, are given in Figs. 8-52 and 8-53.

(3) Accompanied and packed with each equipment is one copy of the actual Government's acceptance test data compiled at the manufacturer's plant. Where the equipment has been subjected to production tests only, the test data includes a copy of complete type test data on similar equipment. This data should be retained on file for reference by the ship or station in which the equipment is installed. The data may also be used as a guide to determine proper operation of the equipment.

(4) To tune the transmitting circuits to any desired frequency in the 300 to 1500 or 1500 to 18100 kcs. bands, the following procedure should be followed:

b. When first tuning up the transmitter, and no previously calibrated frequencies have been determined, an approximate setting to the desired frequency should be made by using the tuning curves, Figs. 8-42 to 8-46 inclusive. Reference should also be made to type test data and typical dial and meter readings Figs. 8-52 and 8-53.

c. After the circuits have been tuned to the approximate frequency desired, exact frequency settings should be determined through the use of an external frequency monitor or other suitable apparatus. Thereafter, the final dial settings should be recorded in their proper place on the calibration chart.

d. Start up and properly regulate the frequency standard that is to be used to calibrate the radio transmitter unit. This frequency standard can be any type of heterodyne frequency meter used in the service that is capable of covering the required frequency range. Due to the frequency stability of the master oscillator units, it is only necessary to set the master oscillator to the desired frequency by the frequency standard. The intermediate amplifiers, power amplifier and antenna tuning circuits may then be adjusted to resonance.

e. R.F. coupling terminals are provided in the motor-generator and rectifier power unit for connec-

tion to the frequency standard. These circuits are between ground and terminals TS1-22 for intermediate frequency (300 to 1500 kcs.) and TS1-23 for high frequency (1500 to 18100 kcs.). When it is desired to calibrate the transmitter, the proper one of these two terminals should be connected to one terminal of the r-f input of the frequency meter. The other terminal of the r-f input to the frequency meter, should be connected to ground on the transmitter or motor-generator and rectifier power unit. Voltage between either one of these two terminals and ground will be sufficient to "power" the frequency meter when operating into an impedance of approximately 75 ohms. If it is desired to listen to the audio output of the frequency meter, connection may be made between the audio output terminals of the frequency meter and audio terminals TS1-20 and TS1-21 in the motor-generator and rectifier power unit. The phones may then be plugged into MICROPHONE jack J-201 on the front panel of the transmitter unit. In this manner, the audio output of the frequency meter may be heard.

f. By reference to tuning curves Figs. 8-42 and 8-45, Curves 271475 and 271098, the master oscillators may be set to their approximate frequency. Then, after setting the frequency meter to the correct frequency, and beating the master oscillator output against this frequency for zero beat, the exact setting of the master oscillator dial may be found. During this operation, the transmitter is operated with the ADJUST-TUNE-OPERATE switch S-207A in the ADJUST position. For frequencies in the I.F. range, the output frequency of the master oscillator is the same as that radiated from the antenna. However, for the H.F. range, the master oscillator never oscillates at a frequency greater than 3000 kcs. All frequencies above this, and up to 18100 kcs., are obtained by means of the multiplier and intermediate amplifier circuit. Because of this, when calibrating the H.F. master oscillator for frequencies greater than 3000 kcs., the frequency at which the master oscillator is working is a sub-multiple of the desired output frequency. However, the master oscillator produces a wave which is rich in harmonics. For this reason, it is often possible to tune the frequency meter directly to the output frequency. Care should be used in selecting the frequency to which the master oscillator is tuned in order to be sure that the proper harmonic is being heard. However, by careful use of the calibration curves, Figs. 8-42 through 8-46, it is possible to obtain a close approximation of the proper dial setting and thus obtain the desired output frequency.

18. HIGH FREQUENCY CIRCUIT TUNING.

a. To tune the H.F. transmitter circuits to any desired frequency in the specified band, the following procedures are prescribed:

(1) Place the gang-controlled H.F.-I.F. switch S-213, S-214, S-215, control A in the H.F. position.

(2) Regulate ADJUST-TUNE-OPERATE switch

S-207 to the ADJUST position and start the motor-generator unit.

(3) Check filament voltage and adjust, if necessary, to 10 volts. This operation is performed through the use of FILAMENT VOLTAGE rheostat R-201.

(4) Set H.F. M.O. RANGE switch S-301, control B to the desired point as determined by tuning curve, Fig. 8-42. It is to be noted that the readings in Figs. 8-42, 8-43 and 8-44 are approximate calibrations which vary on all installations.

(5) Set H.F. M.O. TUNING coil L-301, control C to the proper dial setting as given in the tuning curve, Fig. 8-42.

(6) Regulate H.F. MULTIPLIER RANGE switch S-302, control D to the proper point as given on the tuning curve, Fig. 8-43.

(7) Position H.F. MULTIPLIER TUNING capacitor C-312, control E to the proper dial setting as shown on the tuning curve, Fig. 8-43.

(8) Regulate H.F. I.A. RANGE switch S-303, control F to its proper position as indicated on the tuning curve, Fig. 8-44.

(9) Set H.F. I.A. TUNING capacitor C-320, control G to the proper dial setting as given on the tuning curve, Fig. 8-44.

(10) Manipulate H.F. P.A. RANGE switch S-307, control H to its proper position as indicated by the calibrated dial.

(11) Place H.F. P.A. TUNING coil L-309 control J to its proper setting as indicated on the calibrated dial.

(12) Position H.F. ANT. COUPLING capacitor C-329, control K at approximately zero dial setting.

(13) Regulate H.F. ANT. FEED switch S-304, control L to CURRENT or VOLTAGE position depending on length of antenna and operation frequency. Refer to Par. 19. a.

(14) Set CW-MCW-VOICE switch S-202 to the CW position.

(15) Operate TEST key S-208. The I.A. GRID CURRENT meter M-203 and P.A. GRID CURRENT meter M-204 should indicate current of not over 5 and 50 ma. respectively.

b. Place ADJUST-TUNE-OPERATE switch S-207 to the TUNE position. Close TEST key S-208. Then, tune each stage to exact resonance as follows:

(1) If the frequency is higher than 3000 kcs., retune H.F. MULTIPLIER TUNING capacitor C-312, control E for maximum current on INT. AMPL. GRID CURRENT meter M-203. If the frequency is less than 3000 kcs., this control will have no effect on tuning.

(2) Tune H.F. I.A. TUNING capacitor C-320, control G for maximum current on P.A. GRID CURRENT meter M-204.

(3) Tune H.F. P.A. TUNING coil L-309, control J for minimum reading on P.A. PLATE CURRENT meter M-201.

c. Select either VOLTAGE or CURRENT feed on ANT. FEED switch S-304, control L depending on size of antenna employed. See Par. 19 for further details on antenna characteristics and tuning. Adjust H.F. ANTENNA TUNING INDUCTANCE L-310, control N and H.F. ANTENNA TUNING CAPACITOR C-330, control M until maximum H.F. antenna current is obtained.

d. H.F. ANTENNA COUPLING capacitor C-329, control K may have to be increased in order to obtain an antenna current reading. Do not increase antenna coupling any more than just enough to obtain a good indication. This is especially true when voltage feeding a high resistance antenna. Under this condition, the antenna current is necessarily small. When tuning the antenna circuit, it may be found necessary to return H.F. P.A. TUNING coil L-309, control J and ANT. TUNING CAPACITOR C-330, control M simultaneously in order to obtain the proper condition of resonance.

e. As soon as an indication of antenna current has been obtained, and ANT. TUNING CAPACITOR C-330, control M and ANT. TUNING INDUCTANCE L-310, control N have been adjusted to give maximum antenna current, release TEST key S-208, place ADJUST-TUNE-OPERATE switch S-207 in the OPERATE position, press TEST key S-208 and adjust PLATE VOLTAGE rheostat R-501 for 2000 volts. Increase H.F. ANT. COUPLING capacitor C-329, control K and adjust ANT. TUNING CAPACITOR C-330, control M and ANT. TUNING INDUCTANCE L-310, control N for maximum antenna current.

CAUTION

Do not exceed P.A. current of 175 ma. At some frequencies, where the power amplifier grid excitation is low, it will not be possible to load the power amplifier to 175 ma. Proper procedure, when this condition is encountered, is to adjust the circuits for maximum antenna current. This will usually occur with approximately 150 ma. of power amplifier plate current.

19. ANTENNA CHARACTERISTICS AND TUNING.

a. GENERAL

(1) Antennas into which the TDE Series of Equipments may be required to operate, may be longer than $\frac{1}{4}$ or $\frac{1}{2}$ wave length at 18100 kcs. It will therefore be helpful, in order to obtain some idea of the antenna characteristics, to measure the length of the antenna system to be used, prior to calibration of the transmitter with its antenna.

(2) The term "antenna system" includes the linear length of the antenna with its vertical and horizontal components, the length of the trunk, and the length of the antenna lead from the transmitter to the trunk. After the overall length of the single-wire antenna and the operating frequency are known, reference to antenna tuning curves, Figs. 8-48 and

8-49, Dwgs. 7709571 and 7709570, will indicate which method of antenna feed is to be used.

(3) Antenna tuning curves Figs. 8-48 and 8-49, Dwgs. 7709571 and 7709570 may be used for determining whether a given antenna should be CURRENT or VOLTAGE fed. The proximity of grounded objects, such as decks, stacks, masts, etc., will tend to affect the electrical length of an antenna. Therefore, the values obtained from these curves are only approximate for any given installation.

b. HIGH FREQUENCY ANTENNA TUNING.

(1) The H.F. transmitter has two possible combinations which can be used to tune an antenna. In the CURRENT position of ANT. FEED switch S-304, control L, ANT. TUNING CAPACITOR C-330, control M and ANT. TUNING INDUCTANCE L-310, control N are in series with the antenna to ground. In the VOLTAGE position of ANT. FEED switch S-304, control L, capacitor C-330 (control M) and inductance L-310 (control N) are in parallel with the antenna to ground. In addition, in the 1500 to 2600 kcs. range, coil L-310B, which is a fixed section of the antenna coil, may be shorted out in steps from all-in to approximately two-thirds-in to all-out in either the VOLTAGE or CURRENT positions of ANT. FEED switch S-304, control L. This permits tuning into all normal lengths of antenna. In the 2600 to 18100 kcs. range, all of coil L-310B is shorted out. In this manner, tuning into all normal lengths of antenna can be accomplished with coil L-310B and capacitor C-330.

(2) Antenna tuning curve, Fig. 8-49, Dwg. 7709570, should be used as a guide for tuning the H.F. antenna circuits. Although antennas varying from 75 to 300 feet in length are given, it should not be assumed that these are limiting lengths. Satisfactory results can be obtained by using either longer or shorter antenna systems.

Note

This equipment is connected for use with a single antenna. If two antennas are to be used, one for I.F. and one for H.F., the following changes are necessary. Refer to Figs. 8-27, 8-28 and 8-29, Dwgs. 7300501, 7300541 and 7300578, respectively.

1 — Remove the "V" wire from M-303 to switch S-213. Shorten this wire to an appropriate length and reconnect between M-303 and the I.F. antenna bowl.

2 — Remove the external jumper on the outside of the transmitter which connects between the two antenna bowls. The bowl on the left, facing the transmitter, is for the H.F. antenna, and the one on the right being for the I.F. antenna.

c. INTERMEDIATE FREQUENCY ANTENNA TUNING.

(1) The I.F. transmitter section has three pos-

sible positions of ANT. FEED switch S-107, control T. In the VOLTAGE feed position of this switch, ANT. TUNING CAPACITOR C-131, control U and ANT. TUNING INDUCTANCE L-110, control W are connected in parallel. Reference to antenna tuning curve Fig. 8-48, Dwg. 7709571 will indicate when VOLTAGE feed should be used for a given length of antenna.

(2) In the CURRENT feed position of switch S-107, only ANT. TUNING INDUCTANCE L-110, control W is used in series with the antenna. Therefore, ANT. TUNING CAPACITOR C-131, control U will have no effect upon the tuning. In general, the smallest amount of inductance in series with the antenna which will tune the antenna, will produce the most efficient point of operation. Consequently, the higher readings on ANTENNA INDUCTANCE S-106, control V and ANT. TUNING INDUCTANCE L-110, control W should be used.

(3) In the SERIES CAP IN position of ANT. FEED switch S-107, control T, ANT. TUNING INDUCTANCE L-110, control W and ANT. TUNING CAPACITOR C-131, control U are in series. Tap 11 on ANTENNA INDUCTANCE S-106, control V can be used to cut out all of the internal inductance in the equipment except the coupling section of this coil. Therefore, ANT. TUNING INDUCTANCE L-110, control W will have no effect on tap 11. Taps 10 and 11 are not intended to have overlap. As in the case of CURRENT feed, the amount of inductance in the circuit should be kept at a minimum for best efficiency. Tuning should, therefore, be controlled by ANT. TUNING CAPACITOR C-131, control U.

(4) As a final check, all stages should be returned for best performance, and the plate voltmeter set at the normal operating value of 2000 volts. This readjustment is especially necessary on P.A. TUNING coil L-109, control R.

WARNING

Never exceed the value of 175 ma. for the power amplifier plate circuit, and 2000 volts plate voltage at any time during operation of the transmitter.

(5) The obtainable antenna current values vary with different types of antennas and with the frequency. Therefore, a careful check should be made throughout the frequency range of the transmitter to determine the maximum value of antenna current encountered. If the maximum value never exceeds 5 amperes with full power amplifier input, it may be advisable to request a 0 to 5 ampere meter from the Bureau of Ships to replace the normal 0 to 10 ampere meter supplied with the equipment. If the maximum antenna current exceeds the full scale value of 10 amperes on the meter supplied with the equipment, a permanent shunt should be connected across the meter terminals. Varying degrees of shunting can be obtained through the use of different sizes of wires for the shunt. Normally, a short piece of # 10 copper wire will increase

the range sufficiently to cover most conditions encountered in service. The use of a wire larger than # 10, will increase the range of the meter still further. In extreme cases, it may be necessary to request a higher rating ammeter from the Bureau of Ships.

20. INTERMEDIATE FREQUENCY CIRCUIT TUNING.

a. In order to tune the I.F. transmitter circuits to any desired frequency in the 300 to 1500 kcs. band, the following procedures, as outlined below, should be studied and applied to the equipment:

(1) Place the gang-controlled H.F.-I.F. switch S-213, S-214, S-215, control A in the I.F. position.

(2) Regulate ADJUST-TUNE-OPERATE switch S-207 to the ADJUST position and start the motor-generator set.

(3) Check filament voltage and adjust, if necessary, to 10 volts. This operation is performed through the use of the FILAMENT VOLTAGE rheostat R-201.

(4) Position I.F. M.O. RANGE switch S-101, control O to the desired point as determined by the tuning curve, Fig. 8-45. It is to be noted that the readings in Figs. 8-45 and 8-46 are approximate calibrations which vary on all installations.

(5) Regulate I.F. M.O. TUNING coil L-101, control P to the desired position as shown in the tuning curve, Fig. 8-45.

(6) Set I.F. P.A. RANGE switch S-104, control Q to the desired point as given on the tuning curve, Fig. 8-46.

(7) Manipulate I.F. P.A. TUNING coil L-109, control R to the proper dial setting as determined by the tuning curve, Fig. 8-46.

(8) Place I.F. ANT. COUPLING coil L-109, control S at approximately zero setting.

(9) Regulate I.F. ANT. FEED switch S-107, control T to one of the three positions indicated, depending on the length of the antenna. Reference should be made to Pars. 19. a. through 19. c.

b. Place ADJUST-TUNE-OPERATE switch S-207 to the TUNE position. Adjust PLATE VOLTAGE rheostat R-501 until PLATE VOLTAGE meter M-205 indicates 2000 volts with key up. Close TEST key S-208, and tune each stage to exact resonance as follows:

(1) Tune I.F. P.A. TUNING coil L-109, control R for minimum value on P.A. PLATE CURRENT meter M-201.

c. Place ADJUST-TUNE-OPERATE switch S-207 in the OPERATE position and tune the antenna to resonance as indicated in Pars. 19. a. through 19. c. Tap 1 on ANTENNA INDUCTANCE S-106, control V gives maximum inductance, and tap 11 gives minimum inductance. ANT. TUNING INDUCTANCE L-110, control W provides for adjustment of inductance between taps on ANTENNA INDUCTANCE S-106, control V.

d. After the antenna circuit has been tuned as indicated by maximum antenna current, gradually increase ANT. COUPLING coil L-109, control S until P.A. PLATE CURRENT meter M-201 indicates 175 ma. The suitability of the antenna ammeter should, at this time, be investigated throughout the I.F. frequency range. How this is performed is discussed in Par. 19 *c.* (5).

e. Readjust ANT. TUNING INDUCTANCE L-110, control W and ANT. COUPLING coil L-109, control S for maximum antenna current with exactly 175 ma. of power amplifier plate current.

Note

Do not readjust power amplifier I.F.-P.A. TUNING coil L-109, control R. Proper setting for this control is obtained through I.F. ANT. TUNING coil L-109, control S set at zero. It is not to be retuned after coupling is increased.

WARNING

Never exceed the value of 175 ma. for the P.A. plate circuit and 2000 volts plate voltage at any time during operation of the transmitter.

21. ROUTINE OPERATION.

a. TO START AND STOP EQUIPMENT.

(1) First, it must be assumed that the tuning procedure discussed in the preceding paragraphs is correct.

(2) For local control, place REMOTE-LOCAL switch S-203 to LOCAL. The equipment is then started by placing START-STOP switch S-204 to START, or stopped by placing S-204 to STOP. For remote control, place REMOTE-LOCAL switch S-203 to REMOTE. Place START-STOP switch S-204 to START. The equipment is then controlled by the operator's switch at the remote operating position.

b. TO CHANGE FREQUENCY.

(1) Open TEST key S-208. Regulate ADJUST-TUNE-OPERATE switch S-207 to the TUNE position. Place gang-controlled H.F.-I.F. switch S-213, S-214, S-215, control A and ANT. TUNING INDUCTANCE L-110 control W according to the calibration chart for the desired frequency. If operating conditions permit, close TEST key S-208, and note that P.A. PLATE CURRENT meter M-201 indicates between 100 and 175 ma. Place ADJUST-TUNE-OPERATE switch S-207 to OPERATE. With the TEST key S-208 closed, all meters should show normal indications.

c. TO INCREASE OR DECREASE POWER CW-MCW OPERATION.

(1) To decrease power, reduce coupling by means of ANT. COUPLING capacitor C-329, con-

trol K or ANT. COUPLING coil L-109, control S until the desired value is obtained. Quarter power can also be obtained by this method. To increase power, increase coupling through the use of either of the ANT. COUPLING dials, controls K or S, respectively.

WARNING

Do not exceed 175 ma. P.A. plate current on CW, or 120 ma. on MCW as indicated on P.A. PLATE CURRENT meter M-201.

(2) Retune H.F. P.A. TUNING coil L-309, control J for minimum plate current. This must be done after H.F. ANT. COUPLING capacitor C-329, control K has been changed when operating on H.F. When operating on I.F., do not change I.F.-P.A. TUNING coil L-109, control R after it has once been adjusted regardless of the setting of ANT. COUPLING coil L-109, control S.

d. VOICE OPERATION.

(1) For voice operation, tune the transmitter on CW to the desired frequency at full power output. Change CW-MCW-VOICE switch S-202 to VOICE position. To decrease power, reduce ANT. COUPLING capacitor C-329, control K or ANT. COUPLING coil L-109, control S until the desired reduction is obtained. To increase power, increase ANT. COUPLING capacitor C-329 or ANT. COUPLING coil L-109, controls K or S, respectively. Do not exceed 110 ma. as indicated on P.A. PLATE CURRENT meter M-201. Retune P.A. TUNING coil L-309, control J for minimum plate current after ANT. COUPLING capacitor C-329, control K has been changed when operating on H.F. When operating on I.F., do not change P.A. TUNING coil L-109, control R after it has once been adjusted, regardless of the setting of ANT. COUPLING coil L-109, control S.

(2) Terminals TS1-20 and TS1-21 connect to MICROPHONE jack J-201 on the front panel of the transmitter unit. This jack may be used to connect a pair of phones to the audio output of a receiver if it is desired, by simply connecting the audio output of the receiver to these two terminals. This arrangement may be convenient for listening to the output of the transmitter while tuning it, or for listening to the receiver while operating the transmitter from the local position.

e. MCW OPERATION.

(1) For MCW operation, tune the transmitter on CW to the desired frequency at full power output. Change the CW-MCW-VOICE switch S-202 to MCW. When operating on MCW, the P.A. PLATE CURRENT meter M-201 will read approximately 60 per cent of the value for CW operation at the same frequency. The power output will be approximately 25 per cent of the CW output. To decrease or increase power, refer to Par. 21. *c.*

V. PREVENTIVE MAINTENANCE

22. GENERAL, TRANSMITTER.

a. Keeping the equipment in good operating condition is absolutely essential to proper performance. Becoming familiar with the design of any equipment is the first essential for obtaining optimum performance. The following points should be observed for this reason as well as for safety reasons.

b. An accurate record should be kept on all vacuum tubes. This record should contain date of receipt, date placed in service, use intended, hours operated, date of failure, and other pertinent information. Do not allow hot tubes to chill quickly by coming in contact with cold or moist surfaces. Breakage may result. Important information on the care and operation of vacuum tubes will be found in Section VI. VACUUM TUBE DATA.

c. Do not adjust zero reading of meters with power on. It is desirable to have a grounding rod (insulated rod with a flexible insulated wire fastened at one end of the rod and to ground) to attach to circuits or parts before touching them with the hands.

WARNING

Always ground internal apparatus before touching it, even though the power switch may be open. When servicing the Radio Transmitter Unit, always discharge the filter capacitors which may be holding dangerous charges even though power may not be on the set. There are discharge circuits across the power filter capacitors, but this additional precaution of grounding capacitors is essential should the circuit accidentally be open. Remember to take full precautions when investigating trouble.

d. The appearance of the transmitter unit may be maintained by carefully dusting the exterior surfaces daily with a soft, dry cloth. Occasionally, it may be desirable to clean the back and side shields with a cloth moistened with alcohol or uncolored carbon tetrachloride. When painting within the vicinity of the transmitting equipment, cover the units with wrapping paper so that the exterior of sets can be kept free from globules of paint. Do not paint over or attempt to refinish exteriors of units. If proper care is given, the original exterior finish can be maintained throughout the life of equipment. Molded or composition insulation, capacitor plates and moving mechanical parts should be cleaned with a dry cloth. Care must be taken to see that no scratching or damage is performed during the cleaning process. Where *dry*

compressed air is available, it should be used to blow the dust from the interior of the set. In the absence of a dry compressed air source, a hand bellows should be used.

e. When cleaning, never pull or strain the wiring. Continued movement may cause breaks which are difficult to locate and repair. The felt strips, between the wire clamps and the wire, should be kept in place to prevent wire chafing. Some of these felt strips are secured by marine or ambroid cement.

f. Relays should be inspected regularly for rust, noise, and condition of contacts. If the contacts have become rough, they should be smoothed with a jeweler's file or crocus cloth. If badly burned, they should be replaced with spares. Rust on the magnet armature or pole faces may cause noise and chattering. This rust should be removed carefully. A thin coating of Navy lubricant #14P1 on the bright surface will prevent rust. *Do not oil or grease relay bearings* as oil collects dirt and introduces friction. Make certain that all relays and interlocks work freely and are kept in proper adjustment. To neglect them, might result in serious trouble which may be difficult to locate.

g. Keying relay K-202 should be checked regularly to see that the contacts are clean, and keying action is satisfactory. *Do not adjust contacts unless absolutely necessary.* The contacts of the keying relay are set at the factory with a string oscillograph to produce proper keying. Therefore, it is imperative that they be left as set, unless adjustment is absolutely necessary to eliminate arcing or to correct faulty keying. If necessary, the contacts should be adjusted as shown on Fig. 8-50.

h. Special care should be observed in keeping all switches in good condition, keeping them clean and with good contacts. The switch bearings should be given an occasional drop of Navy Type #2075 oil.

i. Slider guides and contacts on the rotating coils should be kept clean and free from binding. A very thin application of Navy lubricant #14P1 may be used on these surfaces to keep them in good operating condition. The roller and coil wire on the rotating coils are silver clad and should require only an occasional dusting. The brass rod on which the roller travels, should, under normal conditions, require the same attention that is required by the roller and wire. Should the rod become corroded, it can be polished bright and clean with a very fine grade of crocus cloth. Make certain that no abrasive remains on the rod.

j. All connections in the master oscillator units should be kept tight and free from corrosion or dirt. Usually, any trouble in unstable frequency can be traced to loose or dirty connections in the master oscillator units.

k. Access to all parts of the master oscillator assembly that may need servicing at any time, may be obtained without removing the master oscillator casting from the frame. Access to the parts is accomplished by letting the transmitter unit down on the leg. The frequency determining circuit parts are covered by a box shield. Access to these parts may be accomplished by removing this shield.

l. Should it be necessary to remove either one of the master oscillator assemblies from the transmitter unit frame, proceed as follows:

(1) Tilt the transmitter unit out of the shield and attach the special supporting leg. Release the holding pins and let the transmitter down to the horizontal position so that it rests on the leg.

(2) Remove all connections to the unit at the rear of the terminal board (I.F. Section TS-7 or H.F. Section TS-5 and TS-6). Mark all leads for convenience.

(3) Remove all pins from dial and front panel connections.

(4) Unscrew the three screws that are used to hold the casting on the bottom deck.

(5) Lift the casting a short distance above the bottom deck and carefully slide the casting out of the transmitter unit.

m. The unit can be replaced in the transmitter frame by reversing the process as described.

23. MOTOR-GENERATOR.

a. Inspect the brushes on D.C. motor and slip rings (D.C. installations only), and on the two high voltage commutators of the generators. Make certain that these brushes slide easily in their boxes and are not worn down.

b. It is important that the commutators be kept in good condition. To this end, the commutators should be inspected every week. They should be wiped clean with a lint-free piece of clean canvas. A slightly rough commutator may be smoothed by using a very fine grade of sandpaper. In smoothing a rough commutator, apply the sandpaper, abrasive side toward the rough edge, and turn the commutator over by hand.

CAUTION

Never clean revolving objects with power applied to the set. Even though power is removed, with the commutator still revolving, dangerous potentials are present. Never use emery cloth or emery paper, as their abra-

sive qualities wear down rapidly and the particles are apt to pit and permanently injure the smooth copper surfaces.

c. Lubrication of all revolving parts which require attention will be discussed in Par. 24.

d. The motor-generator unit should be inspected occasionally to see that the brushes are not sparking excessively. It is also important to note the condition of the commutator and see that its surface is not burned or grooved. The commutators and collector rings must be kept clean, and the brushes properly adjusted and fitted to the commutator or collector rings. Carbon dust forms on parts adjacent to the brushes. Occasionally, this should be removed by means of a hand bellows, if available. In the absence of a hand bellows, this dust may be removed through the use of a lint-free clean canvas cloth. No other attention is required by the commutator when it is taking on a polish and shows no sign of wear.

e. Eventually, the commutator and slip rings will become darkened by the constant brush friction. This is not harmful. However, it is advisable to occasionally clean them with fine sandpaper, grade #00. Should the commutators become grooved or roughened excessively, the armature must be removed from its frame, and the commutator or slip rings accurately turned down on a lathe. After the commutator is turned down, the mica should be undercut. Care must be taken to see that all mica is removed between the bars to a depth of the undercutting.

f. If the machine has been idle for a long period, it is well to examine the commutators before operation. If used on a ship board installation, salt water may have gotten onto the commutator. This eventually results in corrosion, pitting, and green spots. It is obvious that such roughness should be removed before running the machine again. When using paper or stone to touch up the commutator, lift the brushes and do not replace them until all grit is removed.

g. The brushes are set in position at the factory for best commutation. This adjustment should not be altered.

h. Brushes should be replaced when they have worn down to the extent that the brush spring is approaching the end of its travel, and spring tension is destroyed. When new brushes are installed, they should be fitted accurately to the curvature of the commutator or collector. First, the use of coarse sandpaper, then #00 sandpaper is recommended.

i. New brushes should be the same make and grade as those shipped with the machines. Brushes should have only sufficient clearance in the box to slide easily.

j. To replace brushes, remove the brush caps, then remove the old brushes. Insert the new brushes and replace the brush caps. It is important that each

brush move easily and smoothly in its holder. If they are tight, remove them and slightly sandpaper them to fit. After inserting, they should be "ground in" to fit the radius of the commutator. This is accomplished by raising the brushes and wrapping a strip of fine sandpaper of the approximate width of the commutator around the commutator, rough side toward the brushes. Apply spring tension to the brushes. Now, turn the armature over by hand until a radius has been formed on the brush surface. About 70% of the brush area should be so formed for good commutation. Blow out, or wipe away the carbon dust before replacing the covers. The "grinding-in" process is not important on A.C. slip rings.

k. The bearings of the motor-generator unit should be inspected regularly to make sure that they are free and that the armature turns easily. These bearings are of the ball bearing type and should require very little attention.

l. If, for any reason, the housing over the bearings is removed, be very careful to keep all dirt out of the bearings and housings. Remove the brushes by unscrewing the brush caps.

m. In order to remove the bearings, it will first be necessary to remove the motor-generator set from the power unit chassis. First, remove the side plate and one of the end braces on this unit. Then, by uncrewing the nuts in the four corners of the motor-generator set, the set may be lifted from the shockmounts and removed from the unit through one end. The bearings may now be removed from the shaft by means of the bearing pullers. These pullers are supplied in spare parts box # 1. In order to remove the center bearings of the motor-generator set, it is necessary to separate the two units. To separate the two units, remove the four tie bolts which are around the outside circumference of the unit in the center. Then, remove the bolt which holds one of the units to the bed plate. By pulling straight out in the direction of the shaft, the two units may be pulled apart. After the units have been separated, the housing on either one, or both of the units, may be removed and the bearings pulled in the same manner as described above.

n. To recouple the two units, loosely bolt both units to the bed plate. Then slide them together with the key and coupling unit properly aligned. Insert the four tie bolts and screw them up until the units are held rigidly together. Now, adjust the units to the proper place on the bed plate and take up on the bolts. The unit is now ready to be returned to the case and mounted on the shockmounts.

o. The shafts are designed to permit disengaging of the coupling by moving the units apart. To remove one of the machines, therefore, it is unnecessary to remove the other unit from the bed plate.

p. CONTACTOR.

(1) The contactor should require very little care except for inspection of the contacts.

CAUTION

Be sure that there is no voltage on the contactor during the inspection process.

(2) Contacts normally wear to give the best contact surface without attention. A roughened appearance of the contacts is no indication that good contact is not being obtained. If the contacts become badly pitted or blackened, they may be cleaned and smoothed with a fine jeweler's file and crocus cloth. The contacts should be renewed when they are burned away to the extent that the current carrying surfaces are materially affected. Neglect to change contacts may cause the arc to burn the contact. This could cause the contactor to freeze closed, and may otherwise damage the contactor or equipment.

(3) Push the contactor closed by hand to see that no friction is present. Make certain that the alignment is true and no binding will result. Do not use oil, as it is not required. Oil merely gums up the bearings making them sticky and less efficient. For further information, refer to Section IX. COMMERCIAL BULLETINS, especially to Bulletin IL-2546-B.

(4) The sealing surface of the magnet core and armature should be kept clean to insure proper contact.

24. LUBRICATION.

a. TRANSMITTER UNIT.

(1) The M.O. tuning dial bearings, the rotating coil bearings, the variable capacitor bearings and the switch bearings should be lubricated at least once in every six months. Use a few drops of a light penetrating oil, such as Navy lubricant # 2075. It is important that none of the other dials should be lubricated.

(2) The switch contacts and blades should be lubricated with a thin coating of Navy lubricant # 14P1. Do not lubricate H.F. M.O. RANGE control B or I.F. M.O. RANGE control O, switches S-301 or S-101, respectively.

(3) No excess of Navy lubricant # 14P1 should be allowed to remain on the contact surfaces.

b. MOTOR-GENERATOR SET.

(1) The motor-generator unit is equipped with ball bearings. It is shipped with sufficient grease in the bearings to provide for six or more months of service. Check to make certain that the grease cups are filled with the proper lubricant such as Navy lubricant # 14L3. It is important that the grease cups should not be screwed down unless the bearings actu-

ally require lubrication. Excessive grease is detrimental to the bearings. A hot bearing is usually not an indication that lubrication is needed, but rather may be caused by an excess of grease. Clicking bearings is an indication of insufficient lubrication or possibly a defective bearing. At intervals of about six months or more of service, for normal operation, the bearings should be greased. Use a high grade sodium base, clean ball bearing grease, similar to that supplied with the set, or Navy Grade 14L3. When lubricating, remove bearing drain plug. With set running, force in clean grease via the grease cups until clean grease appears at the outlets, then stop supplying grease. Allow set to operate for about fifteen minutes, then replace drain plugs. At intervals of about two years, the bearing cups should be removed and the bearings washed out and repacked with clean grease.

Note

Keep grease and bearings clean. Dirt destroys ball bearings.

(2) The sealing surfaces of the magnet core and armature may be given a very light coating of Navy lubricant #14P1, if they show any sign of wear.

25. MAINTENANCE SCHEDULE.

a. A maintenance schedule, based on the following hints, and strictly adhered to, will do much to keep the transmitting equipment in good operating condition with a minimum of trouble.

b. DAILY:

- (1) Check all control circuits for proper operation.
- (2) Check and record all meter readings in log book.
- (3) Check tuning of equipment on at least three different frequencies.
- (4) Dust exterior of equipment.

c. WEEKLY:

- (1) Carefully clean entire equipment inside and out.
- (2) Inspect and tighten all electrical connections.
- (3) Clean and inspect all contactors and relay contacts.
- (4) Clean all switch blade contacts. A thin layer of Navy lubricant #14P1 will aid in keeping the blades from cutting.
- (5) Clean and inspect all commutators and brushes. Replace brushes when necessary.

d. MONTHLY:

(1) Check all tubes. This can be done by noting the daily meter readings in the log of the transmitter. Any gradual change in the tube, will be indicated by a gradual change in plate current, all other factors being constant. The tubes in need of replacement can thereby be attended to without serious loss of power.

e. SEMI-ANNUALLY:

(1) Lubricate the bearings of the motor-generator with Navy Grade 14L3 grease.

26. TROUBLES AND CAUSES.

a. The following is a list of possible troubles which might be encountered during operation of the TDE Series of Equipments also included in this listing are the causes of the troubles in the order of probability. Should anyone of the listed irregularities occur, it is suggested that the causes be checked in the order given.

b. OPERATING START-STOP SWITCH S-204 DOES NOT OPERATE THE STARTING SOLENOID:

- (1) REMOTE-LOCAL switch S-203 in wrong position.
- (2) Interlocks not properly closed.
- (3) Main power switch open.
- (4) Thermal overload contacts open.
- (5) Incoming line fuses open.
- (6) No line voltage.
- (7) Line voltage too low.
- (8) Link switches in wrong position.

c. START-STOP SWITCH S-204 CAUSES STARTING CONTACTOR TO CLOSE, BUT MOTOR-GENERATOR SET DOES NOT START:

- (1) Poor or no brush contact on motor commutator.
- (2) Open connections between contactor and motor.
- (3) One set of starting contacts not making proper contact.
- (4) Open circuit in series field of motor.

d. CONTACTOR TENDS TO CLOSE, BUT WILL NOT STAY CLOSED:

- (1) Holding resistor R-503, R-505 or R-506 open.
- (2) Link switches in wrong position.
- (3) When connected for 6-wire control, holding contact K-501E, K-502E, K-503E or K-504E not making contact.
- (4) Line voltage too low.

e. MOTOR-GENERATOR RUNS SATISFACTORILY, BUT LOW OR NO PLATE VOLTAGE AT TRANSMITTER:

- (1) Generator high-voltage fuses blown.
- (2) Brushes making poor or no contact on commutator.
- (3) Brush springs broken or making high resistance contact.
- (4) Field rheostat R-501 open or forming high resistance circuit.
- (5) Open connection in wiring between transmitter and motor-generator unit.
- (6) By-pass capacitors partially shorted to ground.
- (7) Open circuit in field of generator.
- (8) PLATE VOLTAGE meter M-205, or meter circuit defective.

f. NO FILAMENT VOLTAGE:

(1) D.C. EQUIPMENT:

- (a) A.C. line fuses F-504 or F-505 blown.
- (b) Link switches in wrong position.
- (c) A.C. slip ring brushes making poor or no contact.

(d) FILAMENT VOLTAGE rheostat R-201 open.

(e) Filament transformer T-201 connection is open.

(f) Defective FILAMENT VOLTAGE meter M-202, or meter circuit.

(2) A.C. EQUIPMENT:

- (a) A.C. line fuses F-504 and F-505 blown.
- (b) Link switches in wrong position.
- (c) FILAMENT VOLTAGE rheostat R-201 open.
- (d) Filament transformer T-201 connection open.

g. OPERATING TEST KEY CAUSES NO INDICATION ON GRID CURRENT METER:

- (1) Some one or more range switches not in proper position.
- (2) No plate voltage on master oscillator tubes.
- (3) The 550 volt generator output fuse F-507 blown.
- (4) Grid bias rectifier fuse F-503 blown.
- (5) Keying relay inoperative.
- (6) Grid bias rectifier vacuum tube not making contact in socket, or not operating properly.
- (7) Open grid leak.
- (8) Open screen or plate series resistance.
- (9) Screen or plate by-pass capacitor broken down.
- (10) Grid bias rectifier transformer T-501 connection open.
- (11) Dirty keying contact.
- (12) Open connection in 550 volt generator circuit.

b. OPERATING TEST KEY DOES NOT OPERATE KEYING RELAY:

- (1) One or more link switches in wrong position.
- (2) Rectifier bias supply fuse F-503 blown.
- (3) Rectifier bias supply not operating properly.
- (4) Keying relay series resistor R-204 open or making high resistance connection.
- (5) TEST key S-208 not making contact.
- (6) Keying relay coil circuit open.

i. OPERATING REMOTE KEY DOES NOT OPERATE KEYING RELAY:

- (1) CW-MCW-VOICE switch S-202 not in proper position or making poor contact.
- (2) Remote key plug not making good contact in remote control unit KEY jack.
- (3) Incorrect or open interconnection between remote control unit and motor-generator and rectifier power unit.
- (4) If the transmitter and motor-generator and rectifier power unit are located at different points,

there may be incorrect or open connections between units.

j. OPERATING MICROPHONE "PUSH-TO-TALK" BUTTON DOES NOT KEY TRANSMITTER:

- (1) CW-MCW-VOICE switch S-202 not in proper position or making poor contact.
- (2) Incorrect or poor connection in microphone or cord and plug.
- (3) Keying relay K-202 inoperative.
- (4) Microphone plug making poor or no contact in MIC jack in remote control unit.
- (5) Microphone keying relay K-203 inoperative.
- (6) One or more link switches not in proper position.
- (7) Incorrect or open interconnection between remote control unit and motor-generator and rectifier power unit.

k. TRANSMITTER DOES NOT MODULATE WHEN OPERATING ON MCW:

- (1) CW-MCW-VOICE switch S-202 not in proper position.
- (2) CW-MCW-VOICE switch S-202 making poor or no contact.
- (3) Audio gain control set too low. Turn clockwise to increase output of tone oscillator.
- (4) Open connection in tone oscillator loop circuit.
- (5) Open or poor connection in P.A. suppressor grid circuit.
- (6) Open circuit in ground connections of resistor R-314 and switch S-202.
- (7) Open connection in audio tone oscillator circuit.

l. TRANSMITTER DOES NOT MODULATE WHEN OPERATING ON VOICE:

- (1) CW-MCW-VOICE switch S-202 not in proper position.
- (2) Microphone plug making poor or no contact in remote control unit MIC jack.
- (3) Incorrect or poor connection in microphone unit or cord and plug.
- (4) CW-MCW-VOICE switch S-202 making poor or no contact.
- (5) Audio gain control set too low. Turn clockwise to increase gain.
- (6) Open connection in P.A. suppressor grid circuit.

m. GRID CURRENT METERS INDICATE SUBNORMAL VALUES:

- (1) One or more range switches or dials incorrectly set.
- (2) Insufficient drive from preceding stage.
- (3) High resistance connection or open circuit in grid circuit. See Par. 26. *r.*

n. AMPLIFIER CIRCUITS DO NOT TUNE PROPERLY:

- (1) Range switches in wrong position.
- (2) Range switches not making proper contact.

- a.* AMPLIFIER CIRCUITS DO NOT TUNE—
NO ANTENNA CURRENT:
- (1) Antenna shorted or open.
 - (2) Antenna ammeter open.
 - (3) Antenna circuit switches not making proper contact.
- b.* SET OPERATES NORMALLY WHEN TEST KEY S-208 IS DOWN, BUT TUBES CONTINUE TO DRAW SOME PLATE CURRENT WHEN KEY IS UP:
- (1) Defective amplifier tubes.
 - (2) Relay making contact or partial contact when key is up.
 - (3) Ground or partial ground on tube socket contacts.
 - (4) Ground on keying circuit causing tubes to run continuously.
 - (5) Center tap on filament transformer T-201 is grounded.
- q.* SET OPERATES NORMALLY, BUT POWER AMPLIFIER GRID CURRENT IS HIGHER THAN NORMAL:
- (1) Grid resistors R-310 and or R-109 shorted.
 - (2) Grid chokes L-308 and or L-108 shorted.
 - (3) Bleeder resistors R-213 or R-214 open.
 - (4) Grid of tube grounded.
 - (5) Defective tube.
- r.* ALL STAGES APPEAR TO FUNCTION AND TUNE PROPERLY, BUT NO GRID OR PLATE CURRENT CAN BE OBTAINED ON POWER AMPLIFIER:
- (1) Open connection in power amplifier grid circuit.
 - (2) Open circuit in grid resistors R-310 and or R-109.
 - (3) Loose connection at bias bleeder resistor R-214.
 - (4) Open circuit in chokes L-308, L-307, L-108, or L-107.
 - (5) Coupling capacitors C-335 or C-111 are open circuited.
 - (6) If more than one stage fails to draw plate current, check for open grid circuit in the earliest stage which does not function.
- s.* AMPLIFIER TUBES HEAT EXCESSIVELY WHEN TEST KEY S-208 IS CLOSED AND ANTENNA CIRCUIT IS IN TUNE:
- (1) Antenna too tightly coupled.
 - (2) Excessive plate current.
 - (3) Defective amplifier tubes.
 - (4) Shorted or defective grid resistors.
- t.* FREQUENCY SKIPS OR JUMPS:
- (1) Defective master oscillator tube. Be sure anchored filament type tube is used in both master oscillators.
 - (2) Variable ground around master oscillator circuits caused by loose box covers, loose screws, etc.
 - (3) Mounting screws of master oscillator tube socket making variable contact with tube base.
 - (4) Defective grid leak R-302, or R-102.
 - (5) Loose grid or plate connection to tube.
 - (6) Master oscillator unit grounding to lead sheath of wiring.
- u.* ON D.C. EQUIPMENTS, MOTOR-GENERATOR RUNS BUT AT TOO LOW A SPEED:
- (1) Line voltage too low.
 - (2) Series field of motor shorted.
- v.* ON D.C. EQUIPMENTS, MOTOR GENERATOR RUNS BUT AT TOO HIGH A SPEED:
- (1) Line voltage too high.
 - (2) Shunt field of motor may be open.
- w.* GENERATOR HEATING:
- (1) Heating of the armature may result from any one of the following causes:
 - (a) Overload.
 - (b) A short circuit of a coil or number of coils in the winding.
 - (c) Grounds in the armature windings or commutator.
 - (d) Poor commutation.
 - (e) Overheating of the entire unit may be caused by:
 1. Unequal air gap.
 2. A shorted or grounded field winding.
 3. A reversed field coil winding.
 - (2) Any of the above troubles cause a large circulating current in the armature windings to the commutator, to the brushes and brush connections, which will cause artificial overloading of the armature. The air gap should not vary over a few per cent either way from average value. All field coils of the shunt type should be within 10 per cent of the same resistance. A lower value than this indicates shorted turns in the windings.
- x.* FIELD COIL HEATING:
- (1) Too high an operating speed on a machine, with a resultant high output voltage.
 - (2) A partial short-circuit of one coil.
 - (3) If the field coils have been removed from the machine and are not reconnected properly, this may also cause excessive heating of the shunt field.
- y.* POOR COMMUTATION AND SPARKING AT BRUSHES:
- (1) Excessive overload.
 - (2) The brushes may not be fitted to the surface of the commutator.
 - (3) The brushes may bind in the holders.
 - (4) The brushes may have reached their limit of wear, and the result of insufficient amount of brush spring tension.
 - (5) Brush pressure insufficient.
 - (6) Some brushes may have excessive pressure, and be taking more than their share of the current.

(7) The carbon brushes may be of an unsuitable grade. Metal graphite brushes are generally not used on voltages higher than 30 to 40 volts. Great care must be taken to be sure that the proper grade is used when replacements are made.

(8) Commutator bars may be loose or projecting above the others.

(9) High Mica. This prevents a proper contacting surface between the brush and the commutator.

(10) A short circuit on the output circuits.

(11) A variation in the air gap of the machine, or

strength of the field poles will also cause severe sparking at the commutator.

z. FAILURE OF GENERATOR TO BUILD UP:

(1) Speed of the set may be below normal.

(2) A reversed shunt field, or one or more of the coils reversed in the series field.

(3) An open circuit in the shunt field.

(4) Brushes making poor contact with the commutator.

(5) Direction of rotation wrong.

VI. VACUUM TUBE DATA

Note

All tubes supplied with the equipment should be used prior to employment of tubes from general stock.

CAUTION

In order to obtain satisfactory tube life, the filament voltage must be maintained at the correct value of 10 volts as indicated by the filament voltmeter. Operation at over rated voltage will reduce the filament life, while operation at under rated voltage will reduce the emission output. Other ratings given throughout the text of this final instruction book must be regarded if optimum tube life is to be obtained.

27. VACUUM TUBES EMPLOYED.

a. The tubes used in the TDE Series of Equipments are as follows:

(1) INTERMEDIATE FREQUENCY TRANSMITTER.

- 1 Navy Type 801 Master Oscillator
- 1 Navy Type 807 Intermediate Amplifier
- 1 Navy Type 803 Power Amplifier

(2) HIGH FREQUENCY TRANSMITTER.

- 1 Navy Type 837 Master Oscillator
- 1 Navy Type 807 Intermediate Amplifier
- 1 Navy Type 803 Power Amplifier

(3) RECTIFIER POWER UNIT.

- 1 Navy Type 5U4G Bias Rectifier

(4) AUDIO UNIT.

- 1 Navy Type 801 Audio Amplifier and Tone Oscillator

b. The vacuum tubes used in this equipment are operated within the limits specified in Navy Specifica-

tion RE-13A-600D. If optimum tube life is to be obtained, the precautions given throughout this instruction book must be observed.

c. When the circuits of the high frequency transmitter have been properly resonated, the grid current of the Navy Type 807 tube, used in the frequency multiplier circuit, will be approximately 1 to 5 milliamperes, as indicated on I.A. GRID CURRENT meter M-203. When the Navy Type 807 tube is used as the intermediate amplifier, the grid current should be negligible, in the order of 0.5 ma., or less. The grid current of the Navy Type 803 tube used in the power amplifier circuit will be approximately 20 to 45 milliamperes as indicated on P.A. GRID CURRENT meter M-204. The input to the Navy Type 803 power amplifier tube should never exceed 175 milliamperes as indicated on P.A. PLATE CURRENT meter M-201. Overloading of the power amplifier tube will result in decreased tube life.

d. The intermediate frequency transmitter circuits, when properly resonated, will result in a grid current of approximately 25 to 45 milliamperes for the Navy Type 803 tube used in the power amplifier circuit. This current will be indicated on P.A. GRID CURRENT meter M-204. The input to the power amplifier tube should never exceed 175 milliamperes as indicated on P.A. PLATE CURRENT meter M-201.

e. Both the Navy Type 801 and Navy Type 803 tubes are of the thoriated filament type. In case of severe overload resulting in the overheating of tubes of this type, the electron emission may be very slight or may be reduced to a point where oscillations will not start. Unless the overload has liberated a large amount of gas, the activity of the filament can usually be restored by operating the tube at normal filament potential for ten minutes or longer with the plate potential off. This reactivating process, if carried out in the equipment, can be accelerated by raising the filament potential, as indicated on FILAMENT VOLTAGE meter M-202, to 12 volts, but no higher.

If the reactivating process is carried out on a test setup, 12 volts should be used for the Type 803 and 9 volts for the Type 801 tube.

f. The useful life of all thoriated filament tubes is usually ended long before the filament burns out. If a tube loses its emission and cannot be reactivated within a reasonable length of time by the method described above, it should be replaced by a new tube.

g. Ordinary care in the handling and use of tubes will minimize accidental damage. Tubes should be handled carefully and must not be allowed to snap into position when being pushed in the socket. In all cases, regardless of the use to which the tubes are put, careful handling and conservative operation will

be amply repaid by longer and more uniform tube life.

CAUTION

Except where indicating instruments are already incorporated in the equipment, operating personnel should not attempt to measure potentials in excess of 500 volts within the equipment due to hazards to life.

28. VACUUM TUBE CHARACTERISTICS.

a. The vacuum tubes used in the TDE Series of Equipments, are operated in accordance with standard practice and Navy Specification RE-13A-600D. A tabulation of tube operating data is given below:

b. NAVY TYPE 801 TUBE AS A CLASS C OSCILLATOR.

READING	FULL LOAD OPERATING DATA
Plate Voltage.....	550 Volts
Plate Current.....	60 Ma.
Control Grid Current (D.C.).....	10 Ma.
Filament Voltage.....	7.5 Volts
Filament Current.....	1.25 Amps.
Plate Dissipation.....	20 Watts

c. NAVY TYPE 801 TUBE AS AN AUDIO AMPLIFIER CLASS A.

READING	FULL LOAD OPERATING DATA
Plate Voltage.....	550 Volts
Plate Current.....	0.050 Amps.
Plate Power Dissipation.....	20 Watts
Filament Voltage.....	7.5 Volts
Filament Current.....	1.25 Amps.
Control Grid Volts.....	-45 Volts

d. NAVY TYPE 837 TUBE AS AN ELECTRON COUPLED OSCILLATOR.

READING	FULL LOAD OPERATING DATA
Plate Voltage.....	500 Volts
Plate Current.....	0.075 Amps.
Plate Power Dissipation.....	12 Watts
Filament Voltage.....	12.6 Volts
Filament Current.....	0.7 Amps.
Control Grid Voltage.....	-200 Volts
Control Grid Current.....	0.008 Amps.
Shield Grid Voltage.....	200 Volts
Shield Grid Current.....	0.030 Amps.
Suppressor Grid Voltage.....	35 Volts
Suppressor Grid Current.....	0.005 Amps.

e. NAVY TYPE 807 TUBE

READING	FULL LOAD OPERATING DATA		
	H.F. CLASS AB	H.F. CLASS C	I.F. CLASS C
Plate Voltage.....	550 Volts	550 Volts	450 Volts
Plate Current.....	0.055 Amps.	0.065 Amps.	0.100 Amps.
Plate Power Dissipation.....	22.5 Watts	22.5 Watts	22.5 Watts
Filament Voltage.....	6.3 Volts	6.3 Volts	6.3 Volts
Filament Current.....	0.9 Amps.	0.9 Amps.	0.9 Amps.
Control Grid Voltage.....	-10 Volts	-140 Volts	-100 Volts
Control Grid Current.....	0.0 Amps.	0.0055 Amps.	0.005 Amps.
Shield Grid Voltage.....	260 Volts	265 Volts	225 Volts
Shield Grid Current.....	0.0055 Amps.	0.010 Amps.	0.020 Amps.

f. NAVY TYPE 803 TUBE AS A CLASS C AMPLIFIER CW.

READING	FULL LOAD OPERATING DATA
Plate Voltage.....	2000 Volts
Plate Current.....	0.175 Amps.
Plate Power Dissipation.....	125 Watts
Filament Voltage.....	10 Volts
Filament Current.....	5 Amps.
Control Grid Voltage.....	-140 Volts
Control Grid Current.....	0.050 Amps.
Shield Grid Voltage.....	350 Volts
Shield Grid Current.....	0.05 Amps.
Suppressor Grid Voltage.....	0 Volts
Suppressor Grid Current.....	0.010 Amps.

g. NAVY TYPE 803 TUBE AS A SUPPRESSOR MODULATED CLASS C AMPLIFIER

READING	FULL LOAD OPERATING DATA
Plate Voltage.....	2000 Volts
Plate Current.....	0.110 Amps.
Plate Power Dissipation.....	125 Watts
Filament Voltage.....	10 Volts
Filament Current.....	5 Amps.
Control Grid Voltage.....	-140 Volts
Control Grid Current.....	0.050 Amps.
Shield Grid Voltage.....	350 Volts
Shield Grid Current.....	0.05 Amps.
Suppressor Grid Voltage.....	-100 Volts
Suppressor Grid Current.....	0 Amps.

h. NAVY TYPE 5U4G TUBE.

READING	FULL LOAD OPERATING DATA
Peak Inverse Voltage.....	1400 Volts
Peak Plate Current.....	0.800 Amps.
Average Plate Current.....	0.125 Amps.
Filament Voltage.....	5 Volts
Filament Current.....	3 Amps.

VII. SERIES PARTS LIST

Spare Parts Lists are printed in a separate catalog NAVSHIPS 900, 389-SP

Note

This Electrical Parts List has been compiled in accordance with Navy Specification RE13A730B with modifications as directed by the Resident Inspector of Naval Material and approved in accordance with Bureau of Ships Letter to all Inspectors, Serial (930cb) EN28/A2-11, Dated 11 May 1944.

ELECTRICAL PARTS FOR MODEL TDE SERIES RADIO TRANSMITTING EQUIPMENTS

Total Per Equipment												Symbol Desig.	Function	Description	Navy Type Number	Navy Spec. Number	Component Mfr.	Component Mfr. Desig.	Contractor's Item No.	Contractor's Drawing Number	All Symbol Designations Involved		
115 V.D.C. -TDE-3	230 V.D.C. -TDE-3	220/440/3/60-TDE-3	115 V.D.C. -TDE-2	230 V.D.C. -TDE-2	220/440/3/60-TDE-2	115 V.D.C. -TDE-1	230 V.D.C. -TDE-1	220/440/3/60-TDE-1	208/3/60 -TDE-1	115/230/1/60-TDE-1	115 V.D.C. -TDE											230 V.D.C. -TDE	220/440/3/60-TDE
1	1	1	1	1	1	1	1	1	1	1	1	1	1	C-101	M.O. Tank Capacitor	0.0016 MFD. $\pm 2\%$, 2500 V. Eff. Test # (5.8, 3.25, 1.5, 0.8) Temperature Coefficient -0.002% $\pm 0.001\%$ per Degree Centigrade, Mica	-481589-002N2	RE48AA122	2	1570K-311	1	7608226-P1	C-101
1	1	1	1	1	1	1	1	1	1	1	1	1	1	C-102	M.O. Tank Capacitor	0.0025 MFD. $\pm 2\%$, 2500 V. Eff. Test # (5, 3.5, 1.5, 0.7) Temperature Coefficient -0.003% $\pm 0.001\%$ per Degree Centigrade, Mica*	-481590-003N2	RE48AA122	2	1570K-239	2	7608226-P2	C-102
1	1	1	1	1	1	1	1	1	1	1	1	1	1	C-103	M.O. Tank Capacitor	0.0006 MFD. $\pm 2\%$, 2500 V. Eff. Test # (3.5, 1.75, 0.6, 0.25), Temperature Coefficient -0.003% $\pm 0.001\%$ per Degree Centigrade, Mica	-481587-003N2	RE48AA122	2	1570K-228	3	7608226-P3	C-103, C-127
1	1	1	1	1	1	1	1	1	1	1	1	1	1	C-104	M.O. Grid Blocking Capacitor.	0.002 MFD., 2500 V.D.C. Test 1200 V.D.C. Working, Mica.	-48642-B10	RE48AA112N	3		4	7608226-P4	C-104, C-120
														C-105	Not Used.								
1	1	1	1	1	1	1	1	1	1	1	1	1	1	C-106A	M.O. Filament By-pass Capacitor	0.1 x 0.1 MFD. $\pm 15\%$, 600 V. D.C. Working, Paper	-48313-B15		3		5	7608226-P5	C-106A, C106B
1	1	1	1	1	1	1	1	1	1	1	1	1	1	C-106B	M.O. Filament By-pass Capacitor	Part of C-106A					6		
														C-107	Not Used.								
1	1	1	1	1	1	1	1	1	1	1	1	1	1	C-108	I.A. Grid Coupling Capacitor	30 MMF. Maximum, 5.2 MMF. Minimum, 20 Plates, Variable Air	-482395		4	HF-30-X	7	7608226-P7	C-108
1	1	1	1	1	1	1	1	1	1	1	1	1	1	C-109	I.A. Grid By-pass Capacitor	0.01 MFD., 1000 V.D.C. Test, 600 V.D.C. Working, Mica	-48487-B10	RE48AA112N	3		8	7608226-P8	C-109, C-116, C-128, C-307, C-308, C-310, C-313, C-317, C-319, C-322, C-323, C-324, C-325, C-333, C-334

* Current Ratings (3000, 1000, 300, 100 Kc).

RESTRICTED

7-1

RESTRICTED

Section VII

ELECTRICAL PARTS FOR MODEL TDE SERIES RADIO TRANSMITTING EQUIPMENTS (Continued)

7-2

Section VII

Total Per Equipment												Symbol Desig.	Function	Description	Navy Type Number	Navy Spec. Number	Component Mfr.	Component Mfr. Desig.	Contractor's Item No.	Contractor's Drawing Number	All Symbol Designations Involved	
115 V.D.C. -TDE-3	230 V.D.C. -TDE-3	220/440/3/60 -TDE-3	115 V.D.C. -TDE-2	230 V.D.C. -TDE-2	220/440/3/60 -TDE-2	115 V.D.C. -TDE-1	230 V.D.C. -TDE-1	220/440/3/60 -TDE-1	115/230/1/60 -TDE-1	115 V.D.C. -TDE	230 V.D.C. -TDE											220/440/3/60 -TDE
1	1	1	1	1	1	1	1	1	1	1	1	1	C-110	I.A. Screen By-pass Capacitor	0.02 MFD., 1000 V.D.C. Test, 600 V.D.C. Working, Mica	-48428-B10 B10	RE48AA112N	3		9	7608226-P9	C-110, C-111, C-112, C-117, C-118, C-119, C-125, C-129, C-207, C-306, C-309
1	1	1	1	1	1	1	1	1	1	1	1	1	C-111	I.A. Plate Coupling Capacitor	Same as C-110	-48428-B10				10		
1	1	1	1	1	1	1	1	1	1	1	1	1	C-112	I.A. Plate By-pass Capacitor	Same as C-110	-48428-B10				11		
													C-113 to C-115	Not Used.								
1	1	1	1	1	1	1	1	1	1	1	1	1	C-116	P.A. Grid By-pass Capacitor	Same as C-109	-48487-B10				12		
1	1	1	1	1	1	1	1	1	1	1	1	1	C-117	P.A. Filament By-pass Capacitor	Same as C-110	-48428-B10				13		
1	1	1	1	1	1	1	1	1	1	1	1	1	C-118	P.A. Filament By-pass Capacitor	Same as C-110	-48428-B10				14		
1	1	1	1	1	1	1	1	1	1	1	1	1	C-119	P.A. Screen By-pass Capacitor	Same as C-110	-48428-B10				15		
1	1	1	1	1	1	1	1	1	1	1	1	1	C-120	P.A. Suppressor By-pass Capacitor	Same as C-104	-48642-B10				16		
1	1	1	1	1	1	1	1	1	1	1	1	1	C-121	P.A. Tank Capacitor	0.00009 MFD. ±2%, 5000 Volts Test Eff. * (2, 1, 0.3, 0.1), Mica	-481585-C2	RE48AA131	3		17	7608226-P17	C-121
1	1	1	1	1	1	1	1	1	1	1	1	1	C-122	P.A. Tank Capacitor	0.00025 MFD. ±2%, 5000 Volts Eff. Test * (5, 2.5, 1.6, 1.0, 0.3 Amps. at 3000, 1000, 800, 300, 100 Kc), Mica	-48698-C2	RE48AA131	3		18	7608226-P18	C-122

* Current Ratings (3000, 1000, 300, 100 Kc).

RESTRICTED

RESTRICTED

ELECTRICAL PARTS FOR MODEL TDE SERIES RADIO TRANSMITTING EQUIPMENTS (Continued)

Total Per Equipment												Symbol Desig.	Function	Description	Navy Type Number	Navy Spec. Number	Component Mfr.	Component Mfr. Desig.	Contractor's Item No.	Contractor's Drawing Number	All Symbol Designations Involved		
115 V.D.C. —TDE-3	230 V.D.C. —TDE-3	220/440/3/60—TDE-3	115 V.D.C. —TDE-2	230 V.D.C. —TDE-2	220/440/3/60—TDE-2	115 V.D.C. —TDE-1	230 V.D.C. —TDE-1	220/440/3/60—TDE-1	208/3/60 —TDE-1	115/230/1/60—TDE-1	115 V.D.C. —TDE											230 V.D.C. —TDE	220/440/3/60—TDE
1	1	1	1	1	1	1	1	1	1	1	1	1	1	C-123	P.A. Tank Capacitor	0.0005 MFD. $\pm 2\%$, 5000 Volts Eff. Test # (5.5, 3.5, 2.25, 1.5), Mica	-481586-C2	RE48AA131	3		19	7608226-P19	C-123
1	1	1	1	1	1	1	1	1	1	1	1	1	1	C-124	P.A. Plate By-pass Capacitor	0.01 MFD., 5000 Volts Eff. Test (14, 7 Amps. at 1000, 300 Kc), Mica	-48522-B5	RE48AA131	3		20	7608226-P20	C-124
1	1	1	1	1	1	1	1	1	1	1	1	1	1	C-125	M.O. Grid By-pass Capacitor	Same as C-110	-48428-B10				21		
														C-126	Not Used								
1	1	1	1	1	1	1	1	1	1	1	1	1	1	C-127	M.O. Tank Capacitor	Same as C-103	-481587-003N2				22		
1	1	1	1	1	1	1	1	1	1	1	1	1	1	C-128	M.O. Plate By-pass Capacitor	Same as C-109	-48487-B10				23		
1	1	1	1	1	1	1	1	1	1	1	1	1	1	C-129	I.A. Cathode By-pass Capacitor	Same as C-110	-48428-B10				24		
1	1	1	1	1	1	1	1	1	1	1	1	1	1	C-130	P.A. Tank Capacitor	0.0012 MFD. $\pm 2\%$, 5000 Volts Eff. Test # (9, 5.1, 3, 1.6), Mica	-481588-C2	RE48AA131	3	1550-333	25	7608226-P25	C-130
1	1	1	1	1	1	1	1	1	1	1	1	1	1	C-131	Antenna Series Capacitor	300 MMF. Maximum, 52 MMF. Minimum, 39 Plates with 0.230 Spacing, Variable, Air	-482371		5	TK-300-US	26	7607403-P3	C-131
1	1	1	1	1	1	1	1	1	1	1	1	1	1		Insulation for C-131				5		27		
6	6	6	6	6	6	6	6	6	6	6	6	6	6		Insulation for C-131	Insulator—Moldarta	-61064S		1		28	7708565-G3	
1	1	1	1	1	1	1	1	1	1	1	1	1	1	C-201	Meter By-pass Capacitor	0.006 MFD., 1000 V.D.C. Test, 600 V.D.C. Working, Mica	-48410-B10	RE48AA112N	3		29	7608226-P32	C-201, C-205, C-206, C-208, C-209, C-301
															Spare for C-201	Same as C-201 Except Omit Mounting Bracket	-48410-B10		3		30	7608226-P45	

* Current Ratings (3000, 1000, 300, 100 Kc).

RESTRICTED

7-3

RESTRICTED

Section VII

ELECTRICAL PARTS FOR MODEL TDE SERIES RADIO TRANSMITTING EQUIPMENTS (Continued)

Total Per Equipment											Symbol Desig.	Function	Description	Navy Type Number	Navy Spec. Number	Component Mfr.	Component Mfr. Desig.	Contractor's Item No.	Contractor's Drawing Number	All Symbol Designations Involved			
115 V.D.C. —TDE-3	230 V.D.C. —TDE-3	220/440/3/60—TDE-3	115 V.D.C. —TDE-2	230 V.D.C. —TDE-2	220/440/3/60—TDE-2	115 V.D.C. —TDE-1	230 V.D.C. —TDE-1	220/440/3/60—TDE-1	208/3/60 —TDE-1	115/230/1/60—TDE-1											115 V.D.C. —TDE	230 V.D.C. —TDE	220/440/3/60—TDE
1	1	1	1	1	1	1	1	1	1	1	1	1	1	C-202	Audio—Cathode By-pass Capacitor	0.5 MFD., 400 V.D.C. Working, Paper	-48205-A10	RE48AA129C	3		31	7608226-P33	C-202
														C-203 to C-204	Not Used								
1	1	1	1	1	1	1	1	1	1	1	1	1	1	C-205	Meter By-pass Capacitor	Same as C-201	-48410-B10				32		
1	1	1	1	1	1	1	1	1	1	1	1	1	1	C-206	Filament Meter By-pass Capacitor	Same as C-201	-48410-B10				33		
1	1	1	1	1	1	1	1	1	1	1	1	1	1	C-207	Audio Oscillator Capacitor	Same as C-110	-48428-B10				34		
1	1	1	1	1	1	1	1	1	1	1	1	1	1	C-208	Grid Meter By-pass Capacitor	Same as C-201	-48410-B10				35		
1	1	1	1	1	1	1	1	1	1	1	1	1	1	C-209	Meter By-pass Capacitor	Same as C-201	-48410-B10				36		
0	0	0	0	0	0	0	0	0	0	0	1	1	1	C-210	Audio Input By-pass Capacitor	0.001 MFD., 1000 V. Eff. Test 600 V. Working, Mica	-48645-B10	RE48AA112N	3		37	7608226-P41	C-210
0	0	0	0	0	0	0	0	0	0	0	1	1	1	C-211	Audio Output By-pass Capacitor	0.002 MFD., 1000 V. Eff. Test 600 V. Working, Mica	-48668-B10	RE48AA112N	3		38	7608226-P42	C-211
1	1	1	1	1	1	1	1	1	1	1	1	1	1	C-212	Multiplier By-pass Capacitor	0.005 MFD. ±10 %, 5000 Volts D.C. Test, 2500 Volts Working, Mica	-48372-D10	RE48AA112N	3		39	7608226-P43	C-212
1	1	1	1	1	1	1	1	1	1	1	1	1	1	C-301	I.A. Cathode Capacitor	Same as C-201	-48410-B10				40		
															Spare for C-301	Same as Spare for C-201	-48410-B10				41		

RESTRICTED

RESTRICTED

ELECTRICAL PARTS FOR MODEL TDE SERIES RADIO TRANSMITTING EQUIPMENTS (Continued)

Total Per Equipment												Symbol Desig.	Function	Description	Navy Type Number	Navy Spec. Number	Component Mfr.	Component Mfr. Desig.	Contractor's Item No.	Contractor's Drawing Number	All Symbol Designations Involved		
115 V.D.C. -TDE-3	230 V.D.C. -TDE-3	220/440/3/60-TDE-3	115 V.D.C. -TDE-2	230 V.D.C. -TDE-2	220/440/3/60-TDE-2	115 V.D.C. -TDE-1	230 V.D.C. -TDE-1	220/440/3/60-TDE-1	208/3/60 -TDE-1	115/230/1/60-TDE-1	115 V.D.C. -TDE											230 V.D.C. -TDE	220/440/3/60-TDE
1	1	1	1	1	1	1	1	1	1	1	1	1	1	C-302	M.O. Tank Capacitor	0.00025 MFD. $\pm 2\%$, 2500 Volts Eff. Test, Temp. Coefficient -0.002% $\pm 0.001\%$ Per Degree Centigrade, Mica	-481134- 002N2	RE48AA131	2		42	7608226-P46	C-302
1	1	1	1	1	1	1	1	1	1	1	1	1	1	C-303	M.O. Tank Capacitor	0.0006 MFD. $\pm 2\%$, 2500 Volts Eff. Test, Temp. Coefficient -0.002% $\pm 0.001\%$ Per Degree Centigrade, Mica	-481135- 002N2	RE48AA131	2		43	7608226-P47	C-303
1	1	1	1	1	1	1	1	1	1	1	1	1	1	C-304	M.O. Tank Capacitor	0.00075 MFD. $\pm 2\%$, 2000 Volts Eff. Test, Temp. Coefficient -0.001% $\pm 0.001\%$ Per Degree Centigrade, Mica	-481136- 001N2	RE48AA131	2		44	7608226-P48	C-304
1	1	1	1	1	1	1	1	1	1	1	1	1	1	C-305	M.O. Tank Capacitor	0.003 MFD. $\pm 2\%$, 2000 Volts Eff. Test, Temp. Coefficient -0.001% $\pm 0.001\%$ Per Degree Centigrade, Mica	-481137- 001N2	RE48AA131	2		45	7608226-P49	C-305
1	1	1	1	1	1	1	1	1	1	1	1	1	1	C-306	M.O. Tank Coupling Capacitor	Same as C-110	-48428- B10			46			
1	1	1	1	1	1	1	1	1	1	1	1	1	1	C-307	M.O. Filament By- Pass Capacitor	Same as C-109	-48487- B10			47			
1	1	1	1	1	1	1	1	1	1	1	1	1	1	C-308	M.O. Filter By-Pass Capacitor	Same as C-109	-48487- B10			48			
1	1	1	1	1	1	1	1	1	1	1	1	1	1	C-309	M.O. Screen By-Pass Capacitor	Same as C-110	-48428- B10			49			
1	1	1	1	1	1	1	1	1	1	1	1	1	1	C-310	M.O. Plate By-Pass Capacitor	Same as C-109	-48487- B10			50			
1	1	1	1	1	1	1	1	1	1	1	1	1	1	C-311	M.O. Plate Coupling Capacitor	22 MMF. Max., 5 MMF. Min., 12 Plates with $\frac{1}{8}$ " Spacing, Variable Air	-482372		4	Type "MC" #1872	51	7809663 P1	C-311

RESTRICTED

7-5

RESTRICTED

Section VII

ELECTRICAL PARTS FOR MODEL TDE SERIES RADIO TRANSMITTING EQUIPMENTS (Continued)

Total Per Equipment												Symbol Desig.	Function	Description	Navy Type Number	Navy Spec. Number	Component Mfr.	Component Mfr. Desig.	Contractor's Item No.	Contractor's Drawing Number	All Symbol Designations Involved		
115 V.D.C. —TDE-3	230 V.D.C. —TDE-3	220/440/3/60—TDE-3	115 V.D.C. —TDE-2	230 V.D.C. —TDE-2	220/440/3/60—TDE-2	115 V.D.C. —TDE-1	230 V.D.C. —TDE-1	220/440/3/60—TDE-1	208/3/60 —TDE-1	115/230/1/60—TDE-1	115 V.D.C. —TDE											230 V.D.C. —TDE	220/440/3/60—TDE
1	1	1	1	1	1	1	1	1	1	1	1	1	1	C-312	Double Circuit Tuning Capacitor	150 MMF., 31 Plates with 0.070" Spacing, Variable Air	-482369		1	MTC-150-B	52	7606108-P2	C-312, C-320
1	1	1	1	1	1	1	1	1	1	1	1	1	1		Insulation for C-312	1 Set Complete Insulation for C-312			1		53		
1	1	1	1	1	1	1	1	1	1	1	1	1	1	C-313	I.A. Grid By-Pass Capacitor	Same as C-109	-48487-B10				54		
1	1	1	1	1	1	1	1	1	1	1	1	1	1	C-314	I.A. Grid Coupling Capacitor	0.00004 MFD. ±5%, 1000 V.D.C. Test, 600 V.D.C. Working, Mica	-48667-B5	RE48AA112N	3		55	7608226-P58	C-314
														C-315 to C-316	Not Used								
1	1	1	1	1	1	1	1	1	1	1	1	1	1	C-317	I.A. Screen By-Pass Capacitor	Same as C-109	-48487-B10				56		
														C-318	Not Used								
1	1	1	1	1	1	1	1	1	1	1	1	1	1	C-319	I.A. Plate By-Pass Capacitor	Same as C-109	-48487-B10				57		
1	1	1	1	1	1	1	1	1	1	1	1	1	1	C-320	I.A. Tuning Capacitor	Same as C-312	-482369				58		
1	1	1	1	1	1	1	1	1	1	1	1	1	1		Insulation for C-320	Same as Item 53					59		
														C-321	Not Used								
1	1	1	1	1	1	1	1	1	1	1	1	1	1	C-322	P.A. Grid By-Pass Capacitor	Same as C-109	-48487-B10				60		
1	1	1	1	1	1	1	1	1	1	1	1	1	1	C-323	P.A. Filament By-Pass Capacitor	Same as C-109	-48487-B10				61		
1	1	1	1	1	1	1	1	1	1	1	1	1	1	C-324	P.A. Filament By-Pass Capacitor	Same as C-109	-48487-B10				62		

RESTRICTED

RESTRICTED

ELECTRICAL PARTS FOR MODEL TDE SERIES RADIO TRANSMITTING EQUIPMENTS (Continued)

Total Per Equipment														Symbol Desig.	Function	Description	Navy Type Number	Navy Spec. Number	Component Mfr.	Component Mfr. Desig.	Contractor's Item No.	Contractor's Drawing Number	All Symbol Designations Involved
115 V.D.C. —TDE-3	230 V.D.C. —TDE-3	220/440/3/60—TDE-3	115 V.D.C. —TDE-2	230 V.D.C. —TDE-2	220/440/3/60—TDE-2	115 V.D.C. —TDE-1	230 V.D.C. —TDE-1	220/440/3/60—TDE-1	208/3/60 —TDE-1	115/230/1/60—TDE-1	115 V.D.C. —TDE	230 V.D.C. —TDE	220/440/3/60—TDE										
1	1	1	1	1	1	1	1	1	1	1	1	1	1	C-325	P.A. Screen By-Pass Capacitor	Same as C-109	-48487-B10		63				
1	1	1	1	1	1	1	1	1	1	1	1	1	1	C-326	P.A. Suppressor By-Pass Capacitor	0.002 MFD. ±10%, 1000 V.D.C. Test, 600 V.D.C. Working, Mica	-48021-B10 RE48AA112N	3	64	7608226-P67	C-326		
1	1	1	1	1	1	1	1	1	1	1	1	1	1	C-327	P.A. Plate By-Pass Capacitor	0.006 MFD. 2000 Volts, Eff. Test # (9, 7.5, 4.5, 2.2), Mica	-481133-B5 RE48AA131	3	65	7608226-P68	C-327, C-336		
1	1	1	1	1	1	1	1	1	1	1	1	1	1	C-328	P.A. Tuning Capacitor	215 MMF., 21 Plates with 0.070" Spacing, Variable Air	-482386	4	TCD-210-L	66	7606108-P8	C-328	
1	1	1	1	1	1	1	1	1	1	1	1	1	1		Insulation for C-328	Set of Complete Insulation for C-328		4		67			
6	6	6	6	6	6	6	6	6	6	6	6	6	6		Insulation for C-328	Same as Item 28				68			
1	1	1	1	1	1	1	1	1	1	1	1	1	1	C-329	Antenna Coupling Capacitor	75 MMF., 11 Plates, Variable Air		1		69	7606020-G9	C-329	
1	1	1	1	1	1	1	1	1	1	1	1	1	1		Insulation for C-329	Insanol #193 Plate		1		70	7706950-P2		
1	1	1	1	1	1	1	1	1	1	1	1	1	1	C-330	Antenna Tuning Capacitor	110 MMF., 25 Plates with 0.20" Spacing, Variable	-482370	4	TC-100G	71	7606108 P7	C-330	
1	1	1	1	1	1	1	1	1	1	1	1	1	1		Insulation for C-330	One Set of Complete Insulation for C-330		4		72			
														C-331	Not Used								
														C-332	Not Used								
1	1	1	1	1	1	1	1	1	1	1	1	1	1	C-333	M.O. Filament By-Pass Capacitor	Same as C-109	-48487-B10		73				
1	1	1	1	1	1	1	1	1	1	1	1	1	1	C-334	M.O. Filament By-Pass Capacitor	Same as C-109	-48487-B10		74				

* Current Ratings (3000, 1000, 300, 100 Kc).

RESTRICTED

7-7

RESTRICTED

Section VII

ELECTRICAL PARTS FOR MODEL TDE SERIES RADIO TRANSMITTING EQUIPMENTS (Continued)

Total Per Equipment												Symbol Desig.	Function	Description	Navy Type Number	Navy Spec. Number	Component Mfr.	Component Mfr. Desig.	Contractor's Item No.	Contractor's Drawing Number	All Symbol Designations Involved			
115 V.D.C. -TDE-3	230 V.D.C. -TDE-3	220/440/3/60 -TDE-3	115 V.D.C. -TDE-2	230 V.D.C. -TDE-2	220/440/3/60 -TDE-1	115 V.D.C. -TDE-1	230 V.D.C. -TDE-1	220/440/3/60 -TDE-1	208/3/60 -TDE-1	115/230/1/60 -TDE-1	115 V.D.C. -TDE											230 V.D.C. -TDE	220/440/3/60 -TDE	
1	1	1	1	1	1	1	1	1	1	1	1	1	1	C-335	P.A. Grid Coupling Capacitor	0.00005 MFD. $\pm 10\%$, 2500 V. D.C. Test, 1200 V.D.C. Working, Mica	-48744-B10	RE48AA112N	3		75	7608227 P74	C-335	
1	1	1	1	1	1	1	1	1	1	1	1	1	1	C-336	P.A. Plate By-Pass Capacitor	Same as C-327	-481133-B5				76			
1	1	1	1	1	1	1	1	1	1	1	1	1	1	C-501	Filter Capacitor	8.MFD., 600 V.D.C. Working, Paper	-481171	RE13A488C	2		77	7605848 P24	C-501	
1	1	1	1	1	1	1	1	1	1	1	1	1	1	C-502	H.V. Filter Capacitor	3 MFD., 2000 V.D.C. Working, Paper	-48906	RE13A488C	1		78	7605848 P14	C-502	
1	1	1	1	1	1	1	1	1	1	1	1	1	1	C-503	Low Voltage Filter Capacitor	3 MFD., 600 V.D.C. Working, Paper	-48734	RE13A488C	1		79	7605848 P16	C-503	
1	1	1	1	1	1	1	1	1	1	1	1	1	1	C-504	Low Voltage Filter Capacitor	500 MFD., 15 V.D.C. Working, Electrolytic	-48340	RE13A549A	3		80	7609133 P4	C-504, C-505, C-506, C-507	
1	1	1	1	1	1	1	1	1	1	1	1	1	1	C-505	Low Voltage Filter Capacitor	Same as C-504	-48340				81			
1	1	1	1	1	1	1	1	1	1	1	1	1	1	C-506	Low Voltage Filter Capacitor	Same as C-504	-48340				82			
1	1	1	1	1	1	1	1	1	1	1	1	1	1	C-507	Low Voltage Filter Capacitor	Same as C-504	-48340				83			
1	0	0	1	0	0	1	0	0	0	0	1	0	0	C-601	Motor End Capacitor	0.5 MFD. $+20\%$ -10% , 1000 V. D.C. Test, 600 V.D.C. Work- ing, Paper	-481223-10	RE48A129 RE13A488	2	DYR-6050	84	8-D-2577-P3	C-601, C-602, C-611, C-612	
1	0	0	1	0	0	1	0	0	0	0	1	0	0	C-602	Motor End Capacitor	Same as C-601	-481223-10				85			
1	0	0	1	0	0	1	0	0	0	0	1	0	0	C-603	Collector End Capacitor	0.025 MFD. $\pm 10\%$, 1000 V.D.C. Test, 600 V.D.C. Working, Mica			3		86	8-D-2576-P9	C-603, C-604, C-613, C-614	

RESTRICTED

RESTRICTED

ELECTRICAL PARTS FOR MODEL TDE SERIES RADIO TRANSMITTING EQUIPMENTS (Continued)

Total Per Equipment												Symbol Desig.	Function	Description	Navy Type Number	Navy Spec. Number	Component Mfr.	Component Mfr. Desig.	Contractor's Item No.	Contractor's Drawing Number	All Symbol Designations Involved
115 V.D.C. -TDE-3	230 V.D.C. -TDE-3	220/440/3/60-TDE-3	115 V.D.C. -TDE-2	230 V.D.C. -TDE-2	220/440/3/60-TDE-2	115 V.D.C. -TDE-1	230 V.D.C. -TDE-1	220/440/3/60-TDE-1	208/3/60 -TDE-1	115 V.D.C. -TDE	230 V.D.C. -TDE										
1	0	0	1	0	0	1	0	0	0	0	0	0	C-604	Collector End Capacitor	Same as C-603			87			
													C-605 to C-610	Not Used							
0	1	0	0	1	0	0	1	0	0	0	0	1	C-611	Motor End Capacitor	Same as C-601	-481223-10		88			
0	1	0	0	1	0	0	1	0	0	0	0	1	C-612	Motor End Capacitor	Same as C-601	-481223-10		89			
0	1	0	0	1	0	0	1	0	0	0	0	1	C-613	Collector End Capacitor	Same as C-603			90			
0	1	0	0	1	0	0	1	0	0	0	0	1	C-614	Collector End Capacitor	Same as C-603			91			
													C-615 to C-630	Not Used							
1	1	1	1	1	1	1	1	1	1	1	1	1	C-631	Capacitor	0.01 MFD., 5000 V.D.C. Test, 2500 V.D.C. Working, Mica	CM61-103K C75.3-1942	3 9-A-51010 # 1652A Type XNA- 2.5-11	92	8-D-2576-P6	C-631, C-632	
1	1	1	1	1	1	1	1	1	1	1	1	1	C-632	Capacitor	Same as C-631	CM61-103K		93			
1	1	1	1	1	1	1	1	1	1	1	1	1	C-633	Capacitor	0.01 MFD., 2500 V.D.C. Test, 1200 V.D.C. Working, Mica	CM56-103K C75.3-1942	3 9-A-21010 # 1651A Type XMA- 1.2-11	94	8-D-2576-P3	C-633, C-634	
1	1	1	1	1	1	1	1	1	1	1	1	1	C-634	Capacitor	Same as C-633	CM56-103K		95			
													C-635 to C-640	Not Used							
0	0	0	0	0	0	0	0	0	0	1	0	0	C-641	Starting Capacitor	Electrolytic 320-360 MFD. 110 V.	-482404 RE13A549 RE48A341	31	96	9-D-5820-P1	C-641	

RESTRICTED

7-9

RESTRICTED

Section VII

ELECTRICAL PARTS FOR MODEL TDE SERIES RADIO TRANSMITTING EQUIPMENTS (Continued)

Total Per Equipment												Symbol Desig.	Function	Description	Navy Type Number	Navy Spec. Number	Component Mfr.	Component Mfr. Desig.	Contractor's Item No.	Contractor's Drawing Number	All Symbol Designations Involved			
115 V.D.C. —TDE-3	230 V.D.C. —TDE-3	220/440/3/60—TDE-3	115 V.D.C. —TDE-2	230 V.D.C. —TDE-2	220/440/3/60—TDE-2	115 V.D.C. —TDE-1	230 V.D.C. —TDE-1	220/440/3/60—TDE-1	208/3/60 —TDE-1	115/230/1/60—TDE-1	115 V.D.C. —TDE											230 V.D.C. —TDE	220/440/3/60—TDE	
1	0	0	1	0	0	1	0	0	0	0	1	0	0	E-601	Shaft and Armature Assembly	For 115 V.D.C. Motor			1		97	7-B-8423 Assembly # 1	E-601	
1	0	0	1	0	0	1	0	0	0	0	1	0	0	E-602	Field Coil Set Complete	For 115 V.D.C. Motor			1		98	7-B-8464 Assembly # 1	E-602	
1	0	0	1	0	0	1	0	0	0	0	1	0	0	E-603	Brush Holder	Part of E-603A					99		E-603, E-613	
0	0	0	0	0	0	0	0	0	0	0	0	0	0	E-603A	Brush Holder Assembly	Consists of E-603 & E-605			1		100	9-D-8520 Assembly # 1	E-603A, E-613A	
1	0	0	1	0	0	1	0	0	0	0	1	0	0	E-604	Carbon Brush and Spring	For 115 V.D.C. Motor			1		101	5-D-4201-P2	E-604, E-614	
1	0	0	1	0	0	1	0	0	0	0	1	0	0	E-605	Brush Holder Cap	Part of E-603A			1		102	1-D-8660-P6	E-605, E-615	
1	0	0	1	0	0	1	0	0	0	0	1	0	0	E-606	Brush Holder	Part of E-606A					103		E-606, E-607	
0	0	0	0	0	0	0	0	0	0	0	0	0	0	E-606A	Brush Holder Assembly	Consists of E-606 & E-609			1		104	9-D-8520 Assembly # 2	E-606A, E-607A, E-616A, E-617A	
1	0	0	1	0	0	1	0	0	0	0	1	0	0	E-607	Brush Holder	Same as E-606			1		105			
0	0	0	0	0	0	0	0	0	0	0	0	0	0	E-607A	Brush Holder Assembly	Same as E-606A, E-607 & E-609					106			
1	0	0	1	0	0	1	0	0	0	0	1	0	0	E-608	Carbon, Brush and Spring	For 115 V.D.C. Motor			1		107	4-D-8528-P5	E-608, E-618	
1	0	0	1	0	0	1	0	0	0	0	1	0	0	E-609	Brush Holder Cap	Part of E-606A			1		108	1-D-8660-P3	E-609	
														E-610	Not Used									
0	1	0	0	1	0	0	1	0	0	0	0	1	0	E-611	Shaft and Armature Assembly	For 230 V.D.C. Motor			1		109	7-B-8423 Assembly # 2	E-611	
0	1	0	0	1	0	0	1	0	0	0	0	1	0	E-612	Field Coil Set Complete	For 230 V.D.C. Motor			1		110	7-B-8464 Assembly # 2	E-612	

RESTRICTED

RESTRICTED

ELECTRICAL PARTS FOR MODEL TDE SERIES RADIO TRANSMITTING EQUIPMENTS (Continued)

Total Per Equipment												Symbol Desig.	Function	Description	Navy Type Number	Navy Spec. Number	Component Mfr.	Component Mfr. Desig.	Contractor's Item No.	Contractor's Drawing Number	All Symbol Designations Involved	
115 V.D.C. —TDE-3	230 V.D.C. —TDE-3	220/440/3/60—TDE-3	115 V.D.C. —TDE-2	230 V.D.C. —TDE-2	220/440/3/60—TDE-2	115 V.D.C. —TDE-1	230 V.D.C. —TDE-1	220/440/3/60—TDE-1	208/3/60 —TDE-1	115/230/1/60—TDE-1	115 V.D.C. —TDE											230 V.D.C. —TDE
0	1	0	0	1	0	0	1	0	0	0	0	1	0	E-613	Brush Holder	Part of E-613A, Same as E-603				111		
0	0	0	0	0	0	0	0	0	0	0	0	0	0	E-613A	Brush Holder Assembly	Same as E-603A, E-613 & E-615				112		
0	1	0	0	1	0	0	1	0	0	0	0	1	0	E-614	Carbon Brush & Spring	Same as E-604				113		
0	1	0	0	1	0	0	1	0	0	0	0	1	0	E-615	Brush Holder Cap	Part of E-613A, Same as E-605				114		
0	1	0	0	1	0	0	1	0	0	0	0	1	0	E-616	Brush Holder	Part of E-616A				115	7-B-8432 Assembly # 4	
0	0	0	0	0	0	0	0	0	0	0	0	0	0	E-616A	Brush Holder Assembly	Same as E-606A, E-616 & E-619				116	E-616, E-617	
0	1	0	0	1	0	0	1	0	0	0	0	1	0	E-617	Brush Holder	Part of E-617A, Same as E-616				117		
0	0	0	0	0	0	0	0	0	0	0	0	0	0	E-617A	Brush Holder Assembly	Same as E-606A, E-617 & E-619				118		
0	1	0	0	1	0	0	1	0	0	0	0	1	0	E-618	Carbon, Brush and Spring	Same as E-608				119		
0	1	0	0	1	0	0	1	0	0	0	0	1	0	E-619	Brush Holder Cap	Part of E-616A & E-617A				120	E-619	
														E-620 to E-630	Not Used.							
1	1	1	1	1	1	1	1	1	1	1	1	1	1	E-631	Shaft and Armature Assembly	For Generator			1	121	7-B-8424 Assembly # 1	E-631
1	1	1	1	1	1	1	1	1	1	1	1	1	1	E-632	Field Coil Set Com- plete	For Generator			1	122	7-B-8436 Assembly # 1	E-632
1	1	1	1	1	1	1	1	1	1	1	1	1	1	E-633	Brush Holder L.V.-3	Part of E-633A				123		E-633

RESTRICTED

7-11

RESTRICTED

Section VII

ELECTRICAL PARTS FOR MODEL TDE SERIES RADIO TRANSMITTING EQUIPMENTS (Continued)

Total Per Equipment													Symbol Desig.	Function	Description	Navy Type Number	Navy Spec. Number	Component Mfr.	Component Mfr. Desig.	Contractor's Item No.	Contractor's Drawing Number	All Symbol Designations Involved	
115 V.D.C. -TDE-3	230 V.D.C. -TDE-3	220/440/3/60 -TDE-3	115 V.D.C. -TDE-2	230 V.D.C. -TDE-2	220/440/3/60 -TDE-2	115 V.D.C. -TDE-1	230 V.D.C. -TDE-1	220/440/3/60 -TDE-1	209/3/60 -TDE-1	115/230/1/60 -TDE-1	115 V.D.C. -TDE	230 V.D.C. -TDE											220/440/3/60 -TDE
0	0	0	0	0	0	0	0	0	0	0	0	0	0	E-633A	Brush Holder Assembly	Consists of E-633 & E-638			1		124	9-D-8520 Assembly # 3	E-633A
1	1	1	1	1	1	1	1	1	1	1	1	1	1	E-634	Brush Holder L.V.-4	Part of R-634A					125		E-634
0	0	0	0	0	0	0	0	0	0	0	0	0	0	E-634A	Brush Holder Assembly	Consists of E-634 & E-638			1		126	9-D-8520 Assembly # 4	E-634A
1	1	1	1	1	1	1	1	1	1	1	1	1	1	E-635	Brush Holder for H.V.-4	Part of E-635A					127		E-635
0	0	0	0	0	0	0	0	0	0	0	0	0	0	E-635A	Brush Holder Assembly	Consists of E-635 & E-638			1		128	9-D-8520 Assembly # 5	E-635A
1	1	1	1	1	1	1	1	1	1	1	1	1	1	E-636	Brush Holder H.V.-3	Part of E-636A					129		E-636
0	0	0	0	0	0	0	0	0	0	0	0	0	0	E-636A	Brush Holder Assembly	Consists of E-636 & E-638			1		130	9-D-8520 Assembly # 6	E-636A
4	4	4	4	4	4	4	4	4	4	4	4	4	4	E-637	Carbon Brush & Spring	For Generator			1		131	5-D-4331-P4	E-637
1	1	1	1	1	1	1	1	1	1	1	1	1	1	E-638	Brush Holder Cap	Part of E-633A, E-634A, E-635A and E-636A					132		E-638
2	2	0	2	2	0	2	2	0	0	2	2	2	0	F-501	Line Fuse	250 Volts, 30 Amps., 2" x 3/8" Ferrule Diameter, Cartridge Type			7 8	# 25030 # 2010	133	7609133-P8	F-501, F-502
1	1	0	1	1	0	1	1	0	0	1	1	1	0		Fuse Block	1 to 30 Amps., Dimensions 3 3/8" x 2 3/8" Double Pole, 250 Volts. For F-501			9	# 1917	134	7408458-P58	
1	1	0	1	1	0	1	1	0	0	1	1	1	0	F-502	Line Fuse	Same as F-501					135		
2	2	2	2	2	2	2	2	2	2	2	2	2	2	F-503	Bias Rectifier Fuse	250 Volts, 1/2 Amp.			7	# 4005 "Bus Fusetron"	136	7609133-P11	F-503

ELECTRICAL PARTS FOR MODEL TDE SERIES RADIO TRANSMITTING EQUIPMENTS (Continued)

Total Per Equipment											Symbol Desig.	Function	Description	Navy Type Number	Navy Spec. Number	Component Mfr.	Component Mfr. Desig.	Contractor's Item No.	Contractor's Drawing Number	All Symbol Designations Involved
115 V.D.C. -TDE-3	230 V.D.C. -TDE-3	220/440/3/60-TDE-3	115 V.D.C. -TDE-2	230 V.D.C. -TDE-2	220/440/3/60-TDE-2	115 V.D.C. -TDE-1	230 V.D.C. -TDE-1	220/440/3/60-TDE-1	208/3/60 -TDE-1	115/230/1/60-TDE-1										
1	1	1	1	1	1	1	1	1	1	1		F-504	Fuse Block	Single Pole, 250 Volts for F-503			9 # 3929	137 7408458-P59		
2	2	2	2	2	2	2	2	2	2	2		F-504	A.C. Fuse	250 Volts, 6 Amps.			7 # 25006 8 # 2003	138 7609133-P13	F-504, F-505	
1	1	1	1	1	1	1	1	1	1	1		F-505	A.C. Fuse	Same as F-504				139		
2	2	2	2	2	2	2	2	2	2	2		F-506	H.V. Fuse	2500 Volts, 0.5 Amps.			10 Cat. # 2107	140 7609133-P16	F-506	
2	2	2	2	2	2	2	2	2	2	2		F-507	L.V. Fuse	1000 Volts, 0.5 Amp.			10 Cat. # 2102	141 7609133-P17	F-507	
0	0	2	0	0	2	0	0	2	0	0		F-508	Line Fuse	250 Volts, 15 Amps.			7	142 7609133-P18	F-508, F-509	
0	0	1	0	0	1	0	0	1	0	0		F-509	Line Fuse	Same as F-508				143		
0	0	1	0	0	1	0	0	1	0	0			Fuse Block	Same as Item 134				144		
1	1	1	1	1	1	1	1	1	1	1		I-201A	Bulb	0.11 Amps., 18 Volts			20 S# 549474	145 7608227-P81	I-201A	
1	1	1	1	1	1	1	1	1	1	1		I-201B	Receptacle	With Mounting Less Resistor			1 S# 867328B	146 7608227-P82	I-201B	
1	1	1	1	1	1	1	1	1	1	1		I-201C	Lens	Red			1 S# 549468	147 7608227-P83	I-201C	
0	0	0	0	0	0	0	0	0	0	1		I-1301A	Bulb	0.09 to 0.11 Amps., 12 Volts Telephone Switchboard Lamp			20	148 7608227-P84	I-1301A	
0	0	0	0	0	0	0	0	0	0	1		I-1301B	Receptacle	12 to 48 Volts with Mounting			1 S# 822328	149 7608227-P85	I-1301B	
0	0	0	0	0	0	0	0	0	0	1		I-1301C	Lens	Red, Beetle Type			1 S# 765905	150 7608227-P86	I-1301C	
1	1	1	1	1	1	1	1	1	1	0		I-1302A	Bulb	T3-¼, 12-16 Volts			20 Mazda 1813	151 7608227-P79	I-1302A	
1	1	1	1	1	1	1	1	1	1	0		I-1302B	Receptacle and Lens				11 Type 50	152 7608227-P80	I-1302B	
1	1	1	1	1	1	1	1	1	1	1		J-201	Phone Jack	Single Circuit, External Metal Parts to Withstand 200 Hour Salt Spray Test	-49025B		12 TC-60	153 7608227-P87	J-201, J-1301, J-1303	

RESTRICTED

7-13

RESTRICTED

Section VII

ELECTRICAL PARTS FOR MODEL TDE SERIES RADIO TRANSMITTING EQUIPMENTS (Continued)

Total Per Equipment												Symbol Desig.	Function	Description	Navy Type Number	Navy Spec. Number	Component Mfr.	Component Mfr. Desig.	Contractor's Item No.	Contractor's Drawing Number	All Symbol Designations Involved	
115 V.D.C. -TDE-3	230 V.D.C. -TDE-3	220/44/3/60-TDE-3	115 V.D.C. -TDE-2	230 V.D.C. -TDE-2	220/440/3/60-TDE-2	115 V.D.C. -TDE-1	230 V.D.C. -TDE-1	220/440/3/60-TDE-1	208/3/60 -TDE-1	115/230/1/60-TDE-1	115 V.D.C. -TDE											230 V.D.C. -TDE
1	1	1	1	1	1	1	1	1	1	1	1	1	1	J-202	Microphone Jack	3 Circuit, External Metal Parts to Withstand 200 Hour Salt Spray Test	-49630		12	TC-61	154 7608227-P88	J-202, J-1302
1	1	1	1	1	1	1	1	1	1	1	1	1	1	J-1301	Phone Jack	Same as J-201	-49025B				155	
1	1	1	1	1	1	1	1	1	1	1	1	1	1	J-1302	Microphone Jack	Same as J-202	-49630				156	
1	1	1	1	1	1	1	1	1	1	1	1	1	1	J-1303	Key Jack	Same as J-201	-49025B				157	
														K-201	Not Used							
1	1	1	1	1	1	1	1	1	1	1	1	1	1	K-202	Keying Relay	3 Poles, Single Throw, One Break Per Circuit, Normally Closed	-29294		1		158 7708649-G1	K-202
1	1	1	1	1	1	1	1	1	1	1	1	1	1	K-203	Microphone Relay	Single Circuit Normally Open, Single Armature, Contact Voltage Rating to 110 V.A.C. or V.D.C., Contact Form "A" Silver #14			13	Type "G" PC# W4-1021	159 7608227-P103	K-203
1	0	0	1	0	0	1	0	0	0	0	1	0	0	K-501	Starting Contactor	4 Poles, Single Throw, Normally Open, Interlock, Single Pole, Double Throw, Class 11-200, Size #1 Enclosed Line Starter 115 V.D.C.	-29290		1	DN-130	160 7609157-G1	K-501
1	0	0	1	0	0	1	0	0	0	0	1	0	0	K-501A	Coil for K-501	3600 Turns of # 32 Enamel Copper Wire, D.C. Resistance 253 Ohms, 240 Volts			1	S# 1072626	161 7609133-P34	K-501A
1	0	0	1	0	0	1	0	0	0	0	1	0	0	K-501B	Contact for K-501	Moving			1	S# 899837	162 7609133-P35	K-501B, K-502B, K-503B, K-504B, K-512B
1	0	0	1	0	0	1	0	0	0	0	1	0	0	K-501B	Contact for K-501	Stationary			1	S# 899826	163 7609133-P36	K-501B, K-502B, K-503B, K-504B, K-512B

RESTRICTED

RESTRICTED

ELECTRICAL PARTS FOR MODEL TDE SERIES RADIO TRANSMITTING EQUIPMENTS (Continued)

Total Per Equipment												Symbol Desig.	Function	Description	Navy Type Number	Navy Spec. Number	Component Mfr.	Component Mfr. Desig.	Contractor's Item No.	Contractor's Drawing Number	All Symbol Designations Involved	
115 V.D.C. —TDE-3	230 V.D.C. —TDE-3	220/440/3/60—TDE-3	115 V.D.C. —TDE-2	230 V.D.C. —TDE-2	220/440/3/60—TDE-2	115 V.D.C. —TDE-1	230 V.D.C. —TDE-1	220/440/3/60—TDE-1	208/3/60 —TDE-1	115/230/1/60—TDE-1	115 V.D.C. —TDE											230 V.D.C. —TDE
1	0	0	1	0	0	1	0	0	0	1	0	0	0	K-501H	Spring for K-501B			1	S#899835	164 7609133-P38	K-501H, K-502H, K-503H, K-504H	
1	0	0	1	0	0	1	0	0	0	1	0	0	0	K-501J	Contact for K-501 Interlock	Stationary—Screw			1		165 7604479-G4	K-501J, K-502J, K-503J, K-504J
1	0	0	1	0	0	1	0	0	0	1	0	0	0	K-501K	Contact for K-501 Interlock	Stationary—Bracket			1		166 7408454-G2	K-501K, K-502K, K-503K, K-504K
1	0	0	1	0	0	1	0	0	0	1	0	0	0	K-501K	Contact for K-501 Interlock	Moving			1		167 7408454-G1	K-501K, K-502K, K-503K, K-504K
1	0	0	1	0	0	1	0	0	0	1	0	0	0	K-501N	Spring for K-501 Interlock (Top)	Moving			1		168 7811256-P2	K-501N, K-502N, K-503N, K-504N
1	0	0	1	0	0	1	0	0	0	1	0	0	0	K-501P	Spring for K-501 Interlock (Bottom)	Moving			1		169 7811256-P1	K-501P, K-502P, K-503P, K-504P
1	0	0	1	0	0	1	0	0	0	1	0	0	0		Arc Shield for K-501	Molding			1	S#1016994	170	
1	0	0	1	0	0	1	0	0	0	1	0	0	0		Insulation for K-501 Arm	Micarta			1		171 7408453-P1	
0	1	0	0	1	0	0	1	0	0	0	1	0	0	K-502	Starting Contactor	4 Pole, Single Throw, Nor- mally Open Interlock, Single Pole Double Throw, Class 11-200, Size # 1 Enclosed Line Starter, 230 V.D.C.	-29293		1	DN-130	172 7609157-G2	K-502
0	1	0	0	1	0	0	1	0	0	0	1	0	0	K-502A	Coil for Relay K-502	7400 Turns of # 36 En. Copper Wire, D.C. Resistance 1235 Ohms, 600 Volts			1	S# 944730	173 7609133-P49	K-502A
0	1	0	0	1	0	0	1	0	0	0	1	0	0	K-502B	Contact for K-502	Same as K-501B, Moving					174	
0	1	0	0	1	0	0	1	0	0	0	1	0	0	K-502B	Contact for K-502	Same as K-501B, Stationary					175	

RESTRICTED

7-15

RESTRICTED

Section VII

ELECTRICAL PARTS FOR MODEL TDE SERIES RADIO TRANSMITTING EQUIPMENTS (Continued)

Total Per Equipment													Symbol Desig.	Function	Description	Navy Type Number	Navy Spec. Number	Component Mfr.	Component Mfr. Desig.	Contractor's Item No.	Contractor's Drawing Number	All Symbol Designations Involved
115 V.D.C. -TDE-3	230 V.D.C. -TDE-3	220/440/3/60-TDE-3	115 V.D.C. -TDE-2	230 V.D.C. -TDE-2	220/440/3/60-TDE-2	115 V.D.C. -TDE-1	230 V.D.C. -TDE-1	220/440/3/60-TDE-1	208/3/60 -TDE-1	115/230/1/60-TDE-1	115 V.D.C. -TDE	230 V.D.C. -TDE										
0	1	0	0	1	0	0	1	0	0	0	0	1	0	K-502H	Spring for K-502B	Same as K-501H			176			
0	1	0	0	1	0	0	1	0	0	0	0	1	0	K-502J	Contact for K-502 Interlock	Same as K-501J			177			
0	1	0	0	1	0	0	1	0	0	0	0	1	0	K-502K	Contact for K-502 Interlock	Same as K-501K Stationary			178			
0	1	0	0	1	0	0	1	0	0	0	0	1	0	K-502K	Contact for K-502 Interlock	Same as K-501K Moving			179			
0	1	0	0	1	0	0	1	0	0	0	0	1	0	K-502N	Spring for K-502 Interlock (Top)	Same as K-501N			180			
0	1	0	0	1	0	0	1	0	0	0	0	1	0	K-502P	Spring for K-502 Interlock (Bottom)	Same as K-501P			181			
0	1	0	0	1	0	0	1	0	0	0	0	1	0		Arc Shield for K-502	Same as Item 170			182			
0	1	0	0	1	0	0	1	0	0	0	0	1	0		Insulation for K-502 Arm.	Same as Item 171			183			
0	0	1	0	0	1	0	0	1	1	0	0	0	1	K-503	Starting Contactor	4 Pole, Single Throw, Nor- mally Open, Interlock, Single Pole, Double Throw, Class 11-200, Size #1 Enclosed Line Starter 220/440 V.A.C.	-29291	1	DN-130	184	7609157-G4	K-503
0	0	1	0	0	1	0	0	1	1	0	0	0	1	K-503A	Coil for K-503	1250 Turns of #28 En. Copper Wire, D.C. Resistance 1250 Ohms, 100 Volts		1	S# 1040116	185	7609133-P64	K-503A, K-504A
0	0	1	0	0	1	0	0	1	1	0	0	0	1	K-503B	Contact for K-503	Same as K-501B, Moving			186			
0	0	1	0	0	1	0	0	1	1	0	0	0	1	K-503B	Contact for K-503	Same as K-501B, Stationary			187			
0	0	1	0	0	1	0	0	1	1	0	0	0	1	K-503H	Contact for K-503	Same as K-501H			188			

RESTRICTED

RESTRICTED

ELECTRICAL PARTS FOR MODEL TDE SERIES RADIO TRANSMITTING EQUIPMENTS (Continued)

Total Per Equipment													Symbol Desig.	Function	Description	Navy Type Number	Navy Spec. Number	Component Mfr.	Component Mfr. Desig.	Contractor's Item No.	Contractor's Drawing Number	All Symbol Designations Involved
115 V.D.C. --TDE-3	230 V.D.C. --TDE-3	220/440/3/60--TDE-3	115 V.D.C. --TDE-2	230 V.D.C. --TDE-2	220/440/3/60--TDE-2	115 V.D.C. --TDE-1	230 V.D.C. --TDE-1	220/440/3/60--TDE-1	208/3/60 --TDE-1	115/230/1/60--TDE-1	115 V.D.C. --TDE	230 V.D.C. --TDE										
0	0	1	0	0	1	0	0	1	1	0	0	0	1	K-503J	Spring for K-503 Interlock	Same as K-501J				189		
0	0	1	0	0	1	0	0	1	1	0	0	0	1	K-503K	Contact for K-503 Interlock	Same as K-501K, Sta.				190		
0	0	1	0	0	1	0	0	1	1	0	0	0	1	K-503K	Contact for K-503 Interlock	Same as K-501K, Moving				191		
0	0	1	0	0	1	0	0	1	1	0	0	0	1	K-503N	Contact for K-503 Interlock (Top)	Same as K-501N				192		
0	0	1	0	0	1	0	0	1	1	0	0	0	1	K-503P	Spring for K-503 Interlock (Bottom)	Same as K-501P				193		
0	0	1	0	0	1	0	0	1	1	0	0	0	1		Arc Shield for K-503	Same as Item 170				194		
0	0	1	0	0	1	0	0	1	1	0	0	0	1		Insulation for K-503 Arm.	Same as Item 71				195		
0	0	0	0	0	0	0	0	0	0	1	0	0	0	K-504	Starting Contactor	4 Poles, Single Throw, Normally Open Interlock, Single Pole, Double Throw, Class 11-200, Size #1, Enclosed Line Starter	-29292		1 DN-130	1967609157-G3	K-504	
0	0	0	0	0	0	0	0	0	0	1	0	0	0	K-504A	Coil for K-504	Same as K-503A				197		
0	0	0	0	0	0	0	0	0	0	1	0	0	0	K-504B	Contact for K-504	Same as K-501B, Moving				198		
0	0	0	0	0	0	0	0	0	0	1	0	0	0	K-504B	Contact for K-504	Same as K-501B, Stationary				199		
0	0	0	0	0	0	0	0	0	0	1	0	0	0	K-504H	Spring for K-504	Same as K-501H				200		
0	0	0	0	0	0	0	0	0	0	1	0	0	0	K-504J	Interlock Contact for K-504	Same as K-501J				201		

RESTRICTED

7-17

RESTRICTED

Section VII

ELECTRICAL PARTS FOR MODEL TDE SERIES RADIO TRANSMITTING EQUIPMENTS (Continued)

Total Per Equipment													Symbol Desig.	Function	Description	* Navy Type Number	Navy Spec. Number	Component Mfr.	Component Mfr. Desig.	Contractor's Item No.	Contractor's Drawing Number	All Symbol Designations Involved
115 V.D.C. —TDE-3	230 V.D.C. —TDE-3	220/440/3/60—TDE-3	115 V.D.C. —TDE-2	230 V.D.C. —TDE-2	220/440/3/60—TDE-2	115 V.D.C. —TDE-1	230 V.D.C. —TDE-1	220/440/3/60—TDE-1	208/3/60 —TDE-1	115/230/1/60—TDE-1	115 V.D.C. —TDE	230 V.D.C. —TDE										
0	0	0	0	0	0	0	0	0	1	0	0	0	K-504K	Interlock Contact for K-504	Same as K-501K, Sta.				202			
0	0	0	0	0	0	0	0	0	1	0	0	0	K-504K	Interlock Contact for K-504	Same as K-501K, Moving				203			
0	0	0	0	0	0	0	0	0	1	0	0	0	K-504N	Spring for K-504 Interlock (Top)	Same as K-501N				204			
0	0	0	0	0	0	0	0	0	1	0	0	0	K-504P	Spring for K-504 Interlock (Bottom)	Same as K-501P				205			
1	0	0	1	0	0	1	0	0	0	0	1	0	K-505	Thermal Overload Relay	Part of K-501				206	K-505, K-506, K-507, K-508, K-509, K-510, K-511, K-512		
1	0	0	1	0	0	1	0	0	0	0	1	0	K-505A	Heater for K-505	For 115 V.D.C. Operation		1	S# 966492C	207 7609133-P37	K-505A, K-506A, K-507C, K-508C, K-511A, K-512A		
1	0	0	1	0	0	1	0	0	0	0	1	0	K-505B	Contact for Relay K-505	Moving		1	S# 1033931	208 7609133-P42	K-505B, K-506B, K-507B, K-508B, K-509B, K-510B, K-511B		
1	0	0	1	0	0	1	0	0	0	0	1	0	K-505B	Contact for Relay K-505	Stationary		1	S# 899856	209 7609133-P43	K-505B, K-506B, K-507B, K-508B, K-509B, K-510B, K-511B		
0	1	0	0	1	0	0	1	0	0	0	0	1	K-505C	Heater for K-505	For 230 V.D.C. Operation		1	S# 966486C	210 7609133-P46	K-505C, K-506C, K-507A, K-508A, K-511C, K-512C		
1	0	0	1	0	0	1	0	0	0	0	1	0	K-506	Thermal Overload Relay	Same as K-505				211			

RESTRICTED

RESTRICTED

ELECTRICAL PARTS FOR MODEL TDE SERIES RADIO TRANSMITTING EQUIPMENTS (Continued)

Total Per Equipment												Symbol Desig.	Function	Description	Navy Type Number	Navy Spec. Number	Component Mfr.	Component Mfr. Desig.	Contractor's Item No.	Contractor's Drawing Number	All Symbol Designations Involved
115 V.D.C. —TDE-3	230 V.D.C. —TDE-3	220/440/3/60—TDE-3	115 V.D.C. —TDE-2	230 V.D.C. —TDE-2	220/440/3/60—TDE-2	115 V.D.C. —TDE-1	230 V.D.C. —TDE-1	220/440/3/60—TDE-1	208/3/60 —TDE-1	115/230/1/60—TDE-1	115 V.D.C. —TDE										
1	0	0	1	0	0	1	0	0	0	0	1	0	0	K-506A	Heater for K-506	Same as K-505A			212		
1	0	0	1	0	0	1	0	0	0	0	1	0	0	K-506B	Contact for K-506	Same as K-506B, Moving			213		
1	0	0	1	0	0	1	0	0	0	0	1	0	0	K-506B	Contact for K-506	Same as K-505B, Sta.			214		
1	0	0	1	0	0	1	0	0	0	0	1	0	0	K-506C	Heater for K-506	Same as K-505C			215		
1	0	0	1	0	0	1	0	0	0	0	1	0	0		Spring for K-505 and K-506	Reset Springs, Part of K-501	1	S# 899855	216		
0	1	0	0	1	0	0	1	0	0	0	0	1	0	K-507	Thermal Overload Relay	Same as K-505, Part of K-502			217		
0	1	0	0	1	0	0	1	0	0	0	0	1	0	K-507A	Heater for K-507	Same as K-505C			218		
0	1	0	0	1	0	0	1	0	0	0	0	1	0	K-507B	Contact for K-507	Same as K-505B, Moving			219		
0	1	0	0	1	0	0	1	0	0	0	0	1	0	K-507B	Contact for K-507	Same as K-505B, Stationary			220		
1	0	0	1	0	0	1	0	0	0	0	1	0	0	K-507C	Heater for K-507	Same as K-505A			221		
0	1	0	0	1	0	0	1	0	0	0	0	1	0	K-508	Thermal Overload Relay	Same as K-505, Part of K-502			222		
0	1	0	0	1	0	0	1	0	0	0	0	1	0	K-508A	Heater for K-508	Same as K-505C			223		
0	1	0	0	1	0	0	1	0	0	0	0	1	0	K-508B	Contact for K-508	Same as K-505B, Moving			224		
0	1	0	0	1	0	0	1	0	0	0	0	1	0	K-508B	Contact for K-508	Same as K-505B			225		
1	0	0	1	0	0	1	0	0	0	0	1	0	0	K-508C	Heater for K-508	Same as K-505A			226		
0	1	0	0	1	0	0	1	0	0	0	0	1	0		Springs for K-507 and K-508	Reset Springs, Part of K-502	1	S# 899855	227		
0	0	1	0	0	1	0	0	1	1	0	0	0	1	K-509	Thermal Overload Relay	Same as K-505, Part of K-503			228		

RESTRICTED

F-19

RESTRICTED

Section VII

ELECTRICAL PARTS FOR MODEL TDE SERIES RADIO TRANSMITTING EQUIPMENTS (Continued)

Total Per Equipment													Symbol Desig.	Function.	Description	Navy Type Number	Navy Spec. Number	Component Mfr.	Component Mfr. Desig.	Contractor's Item No.	Contractor's Drawing Number	All Symbol Designations Involved
115 V.D.C. —TDE-3	230 V.D.C. —TDE-3	220/440/3/60—TDE-3	115 V.D.C. —TDE-2	230 V.D.C. —TDE-2	220/440/3/60—TDE-2	115 V.D.C. —TDE-1	230 V.D.C. —TDE-1	220/440/3/60—TDE-1	208/3/60 —TDE-1	115/230/1/60—TDE-1	115 V.D.C. —TDE	230 V.D.C. —TDE										
0	0	1	0	0	1	0	0	1	1	0	0	1	K-509A	Heater for K-509	For 220 V.A.C. Operation		1	S#966481B	229	7609133-P67	K-509A, K-510A	
0	0	1	0	0	1	0	0	1	1	0	0	1	K-509B	Contact for K-509	Same as K-505B, Moving				230			
0	0	1	0	0	1	0	0	1	1	0	0	1	K-509B	Contact for K-509	Same as K-505B, Stationary				231			
0	0	1	0	0	1	0	0	1	1	0	0	1	K-509C	Heater for K-509	For 440 V.A.C. Operation		1	S#966474B	232	7609134-P76	K-509C, K-510C	
0	0	1	0	0	1	0	0	1	1	0	0	1	K-510	Thermal Overload Relay	Same as K-505, Part of K-503				233			
0	0	1	0	0	1	0	0	1	1	0	0	1	K-510A	Heater for K-510	Same as K-509A				234			
0	0	1	0	0	1	0	0	1	1	0	0	1	K-510B	Contact for K-510	Same as K-505B, Moving				235			
0	0	1	0	0	1	0	0	1	1	0	0	1	K-510B	Contact for K-510	Same as K-505B, Stationary				236			
0	0	1	0	0	1	0	0	1	1	0	0	1	K-510C	Heater for K-510	Same as K-509C				237			
0	0	1	0	0	1	0	0	1	1	0	0	1		Springs for K-509 and K-510	Reset Springs, Part of K-503			S#899855	238			
0	0	0	0	0	0	0	0	0	1	0	0	0	K-511	Thermal Overload Relay	Same as K-505, Part of K-504				239			
0	0	0	0	0	0	0	0	0	1	0	0	0	K-511A	Heater for K-504	Same as K-505A (115 V.A.C.)				240			
0	0	0	0	0	0	0	0	0	1	0	0	0	K-511B	Contact for K-504	Same as K-505B Moving				241			
0	0	0	0	0	0	0	0	0	1	0	0	0	K-511B	Contact for K-504	Same as K-505B Stationary				242			
0	0	0	0	0	0	0	0	0	1	0	0	0	K-511C	Heater for K-504	Same as K-505C (230 V.A.C. Operation)				243			
0	0	0	0	0	0	0	0	0	1	0	0	0	K-512	Thermal Overload Relay	Same as K-505, Part of K-504				244			

RESTRICTED

RESTRICTED

ELECTRICAL PARTS FOR MODEL TDE SERIES RADIO TRANSMITTING EQUIPMENTS (Continued)

Total Per Equipment											Symbol Desig.	Function	Description	Navy Type Number	Navy Spec. Number	Component Mfr.	Component Mfr. Desig.	Contractor's Item No.	Contractor's Drawing Number	All Symbol Designations Involved		
115 V.D.C. —TDE-3	230 V.D.C. —TDE-3	220/440/3/60—TDE-3	115 V.D.C. —TDE-2	230 V.D.C. —TDE-2	220/440/3/60—TDE-2	115 V.D.C. —TDE-1	230 V.D.C. —TDE-1	220/440/3/60—TDE-1	208/3/60 —TDE-1	115/230/1/60—TDE-1											115 V.D.C. —TDE	230 V.D.C. —TDE
0	0	0	0	0	0	0	0	0	0	1	0	0	0	K-512A	Heater for K-504	Same as K-505A (115 V.A.C. Operation)			245			
0	0	0	0	0	0	0	0	0	0	1	0	0	0	K-512B	Contact—Moving	Same as K-501B, Moving			246			
0	0	0	0	0	0	0	0	0	0	1	0	0	0	K-512B	Contact—Stationary	Same as K-501B, Stationary			247			
0	0	0	0	0	0	0	0	0	0	1	0	0	0	K-512C	Heater for K-504	Same as K-505C (230 V.A.C. Operation)			248			
1	1	1	1	1	1	1	1	1	1	1	1	1	1	L-101	M.O. Tank Coil	Stator, 2 Sections, First 45 Turns Tapped at 14, 22, 25, 35 and 45 Turns, Second 17 3/4 Turns Both Windings Using Litz Double Silk Covered Wire, Inductance 125 Microhenries Max., 121.8 Microhenries Min. at a Frequency of 1000 Cycles. Rotor Two Sections, First 8 7/8 Turns, Second is 8 7/8 Turns Both Windings Using Litz Double Silk Covered Wire.	-47477		1	249	7708621-G1	L-101
														L-102	Not Used							
1	1	1	1	1	1	1	1	1	1	1	1	1	1	L-103	M.O. Plate R.F. Choke	5.5 MH., 125 MA., 50 Ohms D.C. Resistance	-47444		1	250	7708623-G1	L-103, L-105
1	1	1	1	1	1	1	1	1	1	1	1	1	1	L-104	R.F. M.O. Grid Choke	2.5 MH.	-47442		1	251	7708469-G1	L-104, L-106, L-108, L-304, L-308
1	1	1	1	1	1	1	1	1	1	1	1	1	1	L-105	R.F. Int. Amplifier Grid Choke	Same as L-103	-47444			252		
1	1	1	1	1	1	1	1	1	1	1	1	1	1	L-106	R.F. Int. Amplifier Plate Choke	Same as L-104	-47442			253		

RESTRICTED

7-21

RESTRICTED

Section VII

ELECTRICAL PARTS FOR MODEL TDE SERIES RADIO TRANSMITTING EQUIPMENTS (Continued)

Total Per Equipment											Symbol Desig.	Function	Description	Navy Type Number	Navy Spec. Number	Component Mfr.	Component Mfr. Desig.	Contractor's Item No.	Contractor's Drawing Number	All Symbol Designations Involved		
115 V.D.C. —TDE-3	230 V.D.C. —TDE-3	220/440/3/60—TDE-3	115 V.D.C. —TDE-2	230 V.D.C. —TDE-2	220/440/3/60—TDE-2	115 V.D.C. —TDE-1	230 V.D.C. —TDE-1	220/440/3/60—TDE-1	208/3/60—TDE-1	115/230/1/60—TDE-1											115 V.D.C. —TDE	230 V.D.C. —TDE
1	1	1	1	1	1	1	1	1	1	1	1	1	1	L-107	Int. Amp. Band Pass Coil	75 Turns, Wound Clockwise, of #24 Double Cotton Covered En. Copper Wire	-47479		1	254	7407291-G1	L-107
1	1	1	1	1	1	1	1	1	1	1	1	1	1	L-108	R.F. Power Amplifier Grid Choke	Same as L-104	-47442			255		
1	1	1	1	1	1	1	1	1	1	1	1	1	1	L-109	I.F. P.A. Tank Coil	Stator—3 Sections, First—13 Turns Double Bank Wound, Second—29 Turns Single Layer Wound, Tapped at 5, 14, 16, 23 Turns from Start End, Third—21 Turns Double Bank Wound, All Sections Using En. Wire Stranded and Covered With Two Wrappings of Silk Two Rotors, First—16 Turns, Second—9 Turns, Both Using #38 Litz En. Copper Wire	-47443		1	256	7608524-G2	L-109
1	1	1	1	1	1	1	1	1	1	1	1	1	1	L-110	Antenna Load Coil	Stator, Two Sections—First 106 Turns Tapped at 12, 20, 30, 41, 53, 64, 75, 87 and 102 turns, Second—6 Turns, Both Sections Using En. Copper Wire Stranded and Covered with Two Wrappings of Silk. Two Rotors, First—16 Turns, Second—6 ½ Turns. Both Using Same Wire as Stator Windings	-47486		1	257	7608543-G1	L-110
2	2	2	2	2	2	2	2	2	2	2	2	2	2	L-110A	Spring and Roller Assembly for Coil L-110	Roller is $\frac{5}{32}$ " Wide x $\frac{7}{16}$ " Dia., 2 Springs $1\frac{1}{2}$ " Long of 0.015" Tk. Nickel Silver			1	258	7608542-G2	

ELECTRICAL PARTS FOR MODEL TDE SERIES RADIO TRANSMITTING EQUIPMENTS (Continued)

Total Per Equipment														Symbol Desig.	Function	Description	Navy Type Number	Navy Spec. Number	Component Mfr.	Component Mfr. Desig.	Contractor's Item No.	Contractor's Drawing Number	All Symbol Designations Involved	
115 V.D.C. --TDE-3	230 V.D.C. --TDE-3	220/440/3/60--TDE-3	115 V.D.C. --TDE-2	230 V.D.C. --TDE-2	220/440/3/60--TDE-2	115 V.D.C. --TDE-1	230 V.D.C. --TDE-1	220/440/3/60--TDE-1	208/3/60 --TDE-1	115/230/1/60--TDE-1	115 V.D.C. --TDE	230 V.D.C. --TDE	220/440/3/60--TDE											
2	2	2	2	2	2	2	2	2	2	2	2	2	2	2	L-110B	Spring for Coil L-110	Nickel Silver 2 $\frac{7}{8}$ " x $\frac{3}{8}$ " of 0.015" Tk.			1	◆	259	7606058-P15	
2	2	2	2	2	2	2	2	2	2	2	2	2	2	2	L-110C	Spring for Coil L-110	Nickel Silver 2 $\frac{7}{8}$ " x $\frac{3}{8}$ " of 0.015" Tk.			1		260	7606058-P16	
11	11	11	11	11	11	11	11	11	11	11	11	11	11	11		Insulation for L-110	Isolantite	-61485	RE13A317G RE61A215	32		261	7602239-P74	
9	9	9	9	9	9	9	9	9	9	9	9	9	9	9		Insulation for L-110	Isolantite	-61125	RE13A317G RE61A246	32		262	7602239-P46	
22	22	22	22	22	22	22	22	22	22	22	22	22	22	22		Insulation for L-110	Isolantite	-61486	RE13A317G RE61A246B	32		263	7602239-P72	
1	1	1	1	1	1	1	1	1	1	1	1	1	1	1		Form Coil for L-110	Moldarta			1		264	7708787-P1	
3	3	3	3	3	3	3	3	3	3	3	3	3	3	3		Screw—Special for L-110	Fibre—3200-1, $\frac{7}{16}$ " of $\frac{3}{16}$ " Diameter # 8-32 Thread			1		265	7408287-P2	
11	11	11	11	11	11	11	11	11	11	11	11	11	11	11		Screw—Special for L-110	Fibre—3200-1, 1 $\frac{3}{8}$ " of $\frac{7}{16}$ " Diameter # 10-32 Thread			1		266	7810196-P1	
1	1	1	1	1	1	1	1	1	1	1	1	1	1	1		Spacer—Special for L-110	Micarta— $\frac{11}{16}$ " O.D. by $\frac{9}{16}$ " I.D. x $\frac{5}{8}$ " Long			1		267		
2	2	2	2	2	2	2	2	2	2	2	2	2	2	2		Collar for L-110	Micarta			1		268	7608539-P4	
1	1	1	1	1	1	1	1	1	1	1	1	1	1	1		Sleeve for L-110	Micarta			1		269	7608539-P3	
1	1	1	1	1	1	1	1	1	1	1	1	1	1	1		Disc for L-110	Micarta			1		270	7608539-P2	
1	1	1	1	1	1	1	1	1	1	1	1	1	1	1		Wire for L-110	195 Ft. 162 Strand Litz Wire			1		271	7608545-P4	
1	1	1	1	1	1	1	1	1	1	1	1	1	1	1	L-111	P.A. Plate Choke	350 Turns of # 26 Double Silk Covered Wire, D.C. Resistance 6.4 Ohms, Inductance 4.35 Millihenries			1		272	L-303476	L-111

◆ Tie These Items Together.

RESTRICTED

7-23

RESTRICTED

Section VII

ELECTRICAL PARTS FOR MODEL TDE SERIES RADIO TRANSMITTING EQUIPMENTS (Continued)

Total Per Equipment													Symbol Desig.	Function	Description	Navy Type Number	Navy Spec. Number	Component Mfr.	Component Mfr. Desig.	Contractor's Item No.	Contractor's Drawing Number	All Symbol Designations Involved		
115 V.D.C. --TDE-3	230 V.D.C. --TDE-3	220/440/3/60--TDE-3	115 V.D.C. --TDE-2	230 V.D.C. --TDE-2	220/440/3/60--TDE-2	115 V.D.C. --TDE-1	230 V.D.C. --TDE-1	220/440/3/60--TDE-1	208/ 760 --TDE-1	110/230/1/60--TDE-1	115 V.D.C. --TDE	230 V.D.C. --TDE											220/440/3/60--TDE	
1	1	1	1	1	1	1	1	1	1	1	1	1	1	L-201	Tone Oscillator Choke	2000 Turns of # 34 En. Covered Wire, D.C. Resistance 115 Ohms, Inductance 2 Henries Max., 1.165 Henries Min.	-301530		14		273	L-365752	L201	
1	1	1	1	1	1	1	1	1	1	1	1	1	1	L-301	M.O. Tank Coil	Stator—Two Sections, First 10 3/4 Turns Tapped at 3, 6, 10 Turns from Finish End, Second—3 1/2 Turns Both Sections Using # 14 Silver Clad Invar Wire. Rotor, 6 Turns Wound Counter Clockwise of the Same Wire.	-47446		1		274	7708640-G1	L-301	
1	1	1	1	1	1	1	1	1	1	1	1	1	1	L-302	M.O. Filament	150 Turns of # 24 Double Cotton Covered Wire, D.C. Resistance 1.7 Ohms, Inductance 0.55 Millihenries.	-47441		1		275	L-365730	L-320, L-303	
1	1	1	1	1	1	1	1	1	1	1	1	1	1	L-303	M.O. Filament Choke	Same as L-302	-47441				276			
1	1	1	1	1	1	1	1	1	1	1	1	1	1	L-304	M.O. Plate Choke	Same as L-104	-47442				277			
1	1	1	1	1	1	1	1	1	1	1	1	1	1	L-305	Doubler Coil	27 Forms of # 16 Tin Copper Wire Wound Clockwise, Tapped at 7, 13 and 22 Turns from Finish End.	-47447		1		278	7708631-G2	L-305	
														L-306	Not Used.									
1	1	1	1	1	1	1	1	1	1	1	1	1	1	L-307A	I.A. Tank Coil	43 Clockwise Turns Tapped at 3, 7, 13 and 24 Turns from Start End of # 18 Double Cotton Covered Copper Wire.	-47485		1		279	7708631-G1	L-307A	

RESTRICTED

RESTRICTED

ELECTRICAL PARTS FOR MODEL TDE SERIES RADIO TRANSMITTING EQUIPMENTS (Continued)

Total Per Equipment												Symbol Desig.	Function	Description	Navy Type Number	Navy Spec. Number	Component Mfr.	Component Mfr. Desig.	Contractor's Item No.	Contractor's Drawing Number	All Symbol Designations Involved		
115 V.D.C. —TDE-3	230 V.D.C. —TDE-3	220/440/3/60—TDE-3	115 V.D.C. —TDE-2	230 V.D.C. —TDE-2	220/440/3/60—TDE-2	115 V.D.C. —TDE-1	230 V.D.C. —TDE-1	220/440/3/60—TDE-1	208/3/60 —TDE-1	115/230/1/60—TDE-1	115 V.D.C. —TDE											230 V.D.C. —TDE	220/440/3/60—TDE
1	1	1	1	1	1	1	1	1	1	1	1	1	1	L-307B	I.A. Tank Coil	6 Turns of 3/8" O.D. Copper Tubing Pitch Distance of 3/8" Between Turns	-47440		1		280	7708728-G1	L-307B
1	1	1	1	1	1	1	1	1	1	1	1	1	1	L-308	P.A. Grid Choke	Same as L-104	-47442				281		
1	1	1	1	1	1	1	1	1	1	1	1	1	1	L-309A	P.A. Tank Coil	26 1/4 Turns of # 12 Diameter Solid Silver Wire Full Hard.	-47448		1		282	7609284-G10	L-309A
1	1	1	1	1	1	1	1	1	1	1	1	1	1	L-309B	P.A. Tank Coil	44 Clockwise Turns, 10 Per Inch, Tapped at 43 Turns From Start End, # 14 Tinned Copper Wire.	-47476		1		283	7708625-G1	L-309B
2	2	2	2	2	2	2	2	2	2	2	2	2	2	L-309C	Roller Wheel for L-309A	1/2" Long 3/8" Dia., Bronze Bar			1		284	7809266-P2	L-309C, L-310C
1	1	1	1	1	1	1	1	1	1	1	1	1	1	L-309D	Spring for L-309A	3 1/2" x 3/8" of 0.0159" Tk. Grain Lengthwise Copper Alloy Strip			1		285	7810094-P1	L-309D, L-310D
1	1	1	1	1	1	1	1	1	1	1	1	1	1		Spring—Contact				1		286	7706659-P11	
1	1	1	1	1	1	1	1	1	1	1	1	1	1		Spring				1		287	7408151-P3	
1	1	1	1	1	1	1	1	1	1	1	1	1	1		Spring				1		288	7408151-P4	
1	1	1	1	1	1	1	1	1	1	1	1	1	1	L-310A	Antenna Tuning Coil	26 1/4" of # 12 Dia. Solid Silver Wire, Full Hard.	-47449		1		289	7609284-G8	L-310A
1	1	1	1	1	1	1	1	1	1	1	1	1	1	L-310B	Antenna Tuning Coil	Same as Item 283, Except Tap at 19 and 32 Turns.					290	7708625-G2	
1	1	1	1	1	1	1	1	1	1	1	1	1	1		Spring	Same as Item 287					291		
1	1	1	1	1	1	1	1	1	1	1	1	1	1		Spring	Same as Item 288					292		
2	2	2	2	2	2	2	2	2	2	2	2	2	2	L-310C	Roller Wheel for L-310A	Same as L-309C					293		

RESTRICTED

7-25

RESTRICTED

Section VII

ELECTRICAL PARTS FOR MODEL TDE SERIES RADIO TRANSMITTING EQUIPMENTS (Continued)

Total Per Equipment													Symbol Desig.	Function	Description	Navy Type Number	Navy Spec. Number	Component Mfr.	Component Mfr. Desig.	Contractor's Item No.	Contractor's Drawing Number	All Symbol Designations Involved	
115 V.D.C. —TDE-3	230 V.D.C. —TDE-3	220/440/3/60—TDE-3	115 V.D.C. —TDE-2	230 V.D.C. —TDE-2	220/440/3/60—TDE-2	115 V.D.C. —TDE-1	230 V.D.C. —TDE-1	220/440/3/60—TDE-1	088/3/60 —TDE-1	115/230/1/60—TDE-1	115 V.D.C. —TDE	230 V.D.C. —TDE											220/440/3/60—TDE
1	1	1	1	1	1	1	1	1	1	1	1	1	1	L-310D	Spring for L-310A	Same as L-309D					294		
1	1	1	1	1	1	1	1	1	1	1	1	1	1	L-501	Filter Reactor	2400 Turns of # 28 En. Copper Wire, D.C. Resistance 126 Ohms $\pm 15\%$, Test 2000 Volts, 60 Cycle.	-30187		14		295	L-303594	L-501
1	1	1	1	1	1	1	1	1	1	1	1	1	1	L-502	Filter Reactor	210 Turns of # 15 Single Cotton Covered En. Wire, D.C. Resistance 0.35 Ohms $\pm 15\%$, Inductance 0.067 Henries.	-30562		1		296	L-365747	L-502, L-503, L-504
1	1	1	1	1	1	1	1	1	1	1	1	1	1	L-503	Filter Reactor	Same as L-502	-30562				297		
1	1	1	1	1	1	1	1	1	1	1	1	1	1	L-504	Filter Reactor	Same as L-502	-30562				298		
														M-101	Not Used.								
1	1	1	1	1	1	1	1	1	1	1	1	1	1	M-102	I.F. Antenna Current Meter	0 to 10 Amps. R. F. Semi-Uniform Scale with Anti-Glare Glass	-22031A	17-I-12B	1	NT-35	299	7605997-P41	M-102, M-303
1	1	1	1	1	1	1	1	1	1	1	1	1	1	M-201	P.A. Plate Current Meter	0 to 300 M.A. D.C. with Anti-Glare Glass	-22066	17-I-12B	1	NX-35	300	7605997-P39	M-201
1	1	1	1	1	1	1	1	1	1	1	1	1	1	M-202	Filament Voltage Meter	0 to 15 V. A.C. with Anti-Glare Glass	-22080	17-I-12B	1	NA-35	301	7605997-P6	M-202
1	1	1	1	1	1	1	1	1	1	1	1	1	1	M-203	I.A. Grid Meter	0 to 15 M.A. D.C. with Anti-Glare Glass	-22132	17-I-12B	1	NX-35	302	7605997-P40	M-203
1	1	1	1	1	1	1	1	1	1	1	1	1	1	M-204	P.A. Grid Meter	0 to 100 M.A. D.C. with Anti-Glare Glass	-22059	17-I-12B	1	NX-35	303	7605997-P16	M-204
1	1	1	1	1	1	1	1	1	1	1	1	1	1	M-205	Plate Voltage Meter	0 to 2.5 K.V. D.C., 1000 Ohms Per Volt with Anti-Glare Glass—Used with U.S.N. -63774 Multiplier	-22310	17-I-12B	1	NX-35	304	7605997-P42	M-205

RESTRICTED

RESTRICTED

ELECTRICAL PARTS FOR MODEL TDE SERIES RADIO TRANSMITTING EQUIPMENTS (Continued)

Total Per Equipment													Symbol Desig.	Function	Description	Navy Type Number	Navy Spec. Number	Component Mfr.	Component Mfr. Desig.	Contractor's Item No.	Contractor's Drawing Number	All Symbol Designations Involved
115 V.D.C. -TDE3	230 V.D.C. -TDE3	220/440/3/60-TDE3	115 V.D.C. -TDE2	230 V.D.C. -TDE2	220/440/3/60-TDE2	115 V.D.C. -TDE1	230 V.D.C. -TDE1	220/440/3/60-TDE1	208/3/60 -TDE1	115/230/1/60-TDE1	115 V.D.C. -TDE	230 V.D.C. -TDE										
														M-301	Multiplier Only Furnished as Spare	-63774		1	305			
														M-302	Not Used							
1	1	1	1	1	1	1	1	1	1	1	1	1	1	M-303	H.F. Antenna Current Meter	Same as M-102	-22031A			306		
1	0	0	1	0	0	1	0	0	0	0	1	0	0	MG-601	Motor-Generator Set	Input 115 V.D.C., 12.2 Amps. 1.4 Kw; Output Volts: 80 A.C., 12 D.C., 90 D.C., 500 D.C., 2000 D.C., Amps: 2.5, 1.2, 0.05, 0.26, 0.175	-21848	1		307	DL7501675-G3	MG-601
															Consisting of: Motor-Generator	115 V.D.C. Supply Output Given Above	-21851 -21854					
0	1	0	0	1	0	0	1	0	0	0	0	1	0	MG-602	Motor-Generator Set	Input: 230 V.D.C., 6.1 Amps. 1.4 Kw.; Output Volts: 160 A.C., 12 D.C., 90 D.C., 500 D.C., 2000 D.C., Amps.: 1.25, 1.2, 0.060, 0.26, 0.175	-21849	1		308	DL7501675-G5	MG-602
															Consisting of: Motor-Generator	230 V.D.C. Supply Output Given Above	-21852 -21854					
0	0	1	0	0	1	0	0	1	1	0	0	0	1	MG-603	Motor-Generator Set	Input: 220/440/3/60, 6.4/3.2 Amps., 1.4 Kva; Output: Volts 110/220 A.C., 12 D.C., 90 D.C., 550 D.C., 2000 D.C., Amps: 1.8/0.9, 1.2, 0.060, 0.26, 0.175	-21850	1		309	DL7501675-G1	MG-603

RESTRICTED

7-27

RESTRICTED

Section VII

ELECTRICAL PARTS FOR MODEL TDE SERIES RADIO TRANSMITTING EQUIPMENTS (Continued)

Total Per Equipment												Symbol Desig.	Function	Description	Navy Type Number	Navy Spec. Number	Component Mfr.	Component Mfr. Desig.	Contractor's Item No.	Contractor's Drawing Number	All Symbol Designations Involved
115V.D.C. --TDE-3	230 V.D.C. --TDE-3	220/440/3/60--TDE-3	115 V.D.C. --TDE-2	230 V.D.C. --TDE-2	220/440/3/60--TDE-2	115 V.D.C. --TDE-1	230 V.D.C. --TDE-1	220/440/3/60--TDE-1	208/3/60 --TDE-1	115/230/1/60--TDE-1	115 V.D.C. --TDE										
1	1	1	1	1	1	1	1	1	1	1	1	1	1	O-632	Ball Bearing—Rear	Same as O-602			318		
1	1	1	1	1	1	1	1	1	1	0	1	1	1	O-633	Fan Coupling			1	319 7-B-8428 Assembly # 1	O-633, O-643	
0	0	0	0	0	0	0	0	0	0	0	0	0	0	O-634	Bearing Puller			1	320 7-B-8492 Assembly # 1	O-634, O-644	
														O-635 to O-640	Not Used						
0	0	0	0	0	0	0	0	0	0	1	0	0	0	O-641	Ball Bearing —Front	Same as O-601			321		
0	0	0	0	0	0	0	0	0	0	1	0	0	0	O-642	Ball Bearing—Rear	Same as O-602			322		
0	0	0	0	0	0	0	0	0	0	1	0	0	0	O-643	Fan Coupling	Same as O-633			323		
0	0	0	0	0	0	0	0	0	0	0	0	0	0	O-644	Bearing Puller	Same as O-634			324		
														R-101	Not Used						
1	1	1	1	1	1	1	1	1	1	1	1	1	1	R-102	M.O. Grid Resistor	10,000 Ohms, 60 Watts	-63090E	RE13A372J	16	325 7608228-P166	R-102, R-105, R-214, R-305
1	1	1	1	1	1	1	1	1	1	1	1	1	1	R-103	I.A. Filament Resistor	1.33 Ohms ±5%, 10 Watts	-63812E	RE13A372J	16	326 7608228-P167	R-103
														R-104	Not Used						
1	1	1	1	1	1	1	1	1	1	1	1	1	1	R-105	I.A. Grid Resistor	Same as R-102	-63090E			327	
1	1	1	1	1	1	1	1	1	1	1	1	1	1	R-106	I.A. Screen Resistor	5000 Ohms, 20 Watts	-63015E	RE13A372J	16	328 7608228-P169	R-106, R-302, R-309
1	1	1	1	1	1	1	1	1	1	1	1	1	1	R-107	Potentiometer Resistor	12,500 Ohms, 60 Watts	-631022E	RE13A372J	16	329 7608228-P172	R-107, R-108
1	1	1	1	1	1	1	1	1	1	1	1	1	1	R-108	Potentiometer Resistor	Same as R-107	-631022E			330	

RESTRICTED

7-29

RESTRICTED

Section VII

ELECTRICAL PARTS FOR MODEL TDE SERIES RADIO TRANSMITTING EQUIPMENTS (Continued)

Total Per Equipment													Symbol Desig.	Function	Description	Navy Type Number	Navy Spec. Number	Component Mfr.	Component Mfr. Desig.	Contractor's Item No.	Contractor's Drawing Number	All Symbol Designations Involved	
115 V.D.C. —TDE-3	230 V.D.C. —TDE-3	220/440/3/60—TDE-3	115 V.D.C. —TDE-2	230 V.D.C. —TDE-2	220/440/3/60—TDE-2	115 V.D.C. —TDE-1	230 V.D.C. —TDE-1	220/440/3/60—TDE-1	115 V.D.C. —TDE-1	230 V.D.C. —TDE-1	220/440/3/60—TDE-1												
1	1	1	1	1	1	1	1	1	1	1	1	1	R-109	P.A. Grid Resistor	1000 Ohms, 20 Watts	-63011E	RE13A372J	16		331	7608228-P174	R-109, R-211, R-310	
1	1	1	1	1	1	1	1	1	1	1	1	1	R-110	P.A. Screen Resistor	3000 Ohms, 60 Watts	-63081F	RE13A372J	17		332	7608228-P175	R-110, R-311	
1	1	1	1	1	1	1	1	1	1	1	1	1	R-111	I.A. Plate Resistor	2500 Ohms, 60 Watts	-63080E	RE13A372J	16		333	7608228-P176	R-111	
1	1	1	1	1	1	1	1	1	1	1	1	1	R-112	I.A. Cathode Resistor	100 Ohms, 10 Watts	-63676E	RE13A372J	16		334	7608228-P177	R-112	
1	1	1	1	1	1	1	1	1	1	1	1	1	R-201	Filament Resistor	16 Ohms, 100 Watts, Variable	-632346-10	RE13A372J	18	#0447	335	7608228-P183	R-201	
1	1	1	1	1	1	1	1	1	1	1	1	1	R-202	Tune Operate Resistor	10,000 Ohms, 200 Watts	-63217E		16		336	7608228-P184	R-202	
1	1	1	1	1	1	1	1	1	1	1	1	1	R-203	Audio Cathode Bias Resistor	1800 Ohms, 2 Watts, Composition	-63474	RE13A372G	19	BT-2	337	7608228-P185	R-203	
1	1	1	1	1	1	1	1	1	1	1	1	1	R-204	Keying Relay Resistor	400 Ohms, 60 Watts	-63067E	RE13A372J	16		338	7608228-P186	R-204	
1	1	1	1	1	1	1	1	1	1	1	1	1	R-205	Multiplier Resistor	2.5 Megohms, 1.0 Ma., 2.5 Kv. Max.	-63774	RE13A590A	19	MFB	339	7608228-P187	R-205	
1	1	1	1	1	1	1	1	1	1	1	1	1	R-206	Audio Potentiometer Resistor	500,000 Ohms, 1 Watt, Taper A			19	Type CS	340	7608228-P188	R-206	
1	1	1	1	1	1	1	1	1	1	1	1	1	R-207	Sidetone Resistor	1000 Ohms, 1 Watt, Composition	-63288	RE13A372G	19	BT-1	341	7608228-P189	R-207	
1	1	1	1	1	1	1	1	1	1	1	1	1	R-208	Microphone Resistor	100 Ohms \pm 10%, 2 Watts	-63705-10	RE13A372J	19	BW-2	342	7608228-P182	R-208	
1	0	1	1	0	1	1	0	1	1	1	1	0	R-209	Indicator Light Resistor	900 Ohms, 60 Watts	-63075E	RE13A372J	16		343	7608228-P190	R-209	
1	1	1	1	1	1	1	1	1	1	1	1	1	R-210	Suppressor Resistor	15,000 Ohms, 2 Watts	-63474	RE13A372G	19	BT-2	344	7608228-P181	R-210	
1	1	1	1	1	1	1	1	1	1	1	1	1	R-211	Cathode Resistor	Same as R-109	-63011E				345			
1	1	1	1	1	1	1	1	1	1	1	1	1	R-212	Audio Resistor	500,000 Ohms, 1 Watt, Composition	-63288	RE13A372G	19	BT-1	346	7608228-P192	R-212	

RESTRICTED

RESTRICTED

ELECTRICAL PARTS FOR MODEL TDE SERIES RADIO TRANSMITTING EQUIPMENTS (Continued)

Total Per Equipment													Symbol Desig.	Function	Description	Navy Type Number	Navy Spec. Number	Component Mfr.	Component Mfr. Desig.	Contractor's Item No.	Contractor's Drawing Number	All Symbol Designations Involved	
115 V.D.C. --TDE-3	230 V.D.C. --TDE-3	220/440/3/60--TDE-3	115 V.D.C. --TDE-2	230 V.D.C. --TDE-2	220/440/3/60--TDE-2	115 V.D.C. --TDE-1	230 V.D.C. --TDE-1	220/440/3/60--TDE-1	208/3/60 --TDE-1	115/230/1/60--TDE-1	115 V.D.C. --TDE	230 V.D.C. --TDE											220/440/3/60--TDE
1	1	1	1	1	1	1	1	1	1	1	1	1	1	R-213	Bias Loading Resistor	950 Ohms, 20 Watts	-631208F	RE13A372J	17		347	7608228-P193	R-213
1	1	1	1	1	1	1	1	1	1	1	1	1	1	R-214	Bias Resistor	Same as R-102	-63090E				348		
0	1	0	0	1	0	0	1	0	0	0	0	0	1	R-215	Indicator Light Resistor	1950 Ohms, 60 Watts	-631282F	RE13A372J	17	Type D	349	7608228-P213	R-215
1	1	1	1	1	1	1	1	1	1	1	1	1	1	R-301	I.A. Circuit Resistor	800 Ohms $\pm 5\%$, 1 Watt, Composition	-63291	RE13A372G	19	BT-1	350	7608228-P201	R-301
1	1	1	1	1	1	1	1	1	1	1	1	1	1	R-302	M.O. Grid Resistor	Same as R-106	-63015E				351		
1	1	1	1	1	1	1	1	1	1	1	1	1	1	R-303	M.O. Filament Shunt Resistor	50 Ohms $\pm 2\%$, 1 Watt	-63703-2	RE13A372G	19		352	7608228-P198	R-303, R-313, R-314
1	1	1	1	1	1	1	1	1	1	1	1	1	1	R-304	M.O. Screen Resistor	18,000 Ohms, 60 Watts	-63094E	RE13A372J	16		353	7608228-P199	R-304
1	1	1	1	1	1	1	1	1	1	1	1	1	1	R-305	Voltage Dividing Resistor	Same as R-102	-63090E				354		
1	1	1	1	1	1	1	1	1	1	1	1	1	1	R-306	I.A. Cathode Resistor	350 Ohms, 60 Watts	-63066E	RE13A372J	16		355	7608228-P209	R-306
1	1	1	1	1	1	1	1	1	1	1	1	1	1	R-307	I.A. Grid Resistor	50,000 Ohms, 5 Watts, $\frac{1}{2}$ Diameter		RE13A372G	6	Type A	356	7608228-P202	R-307
1	1	1	1	1	1	1	1	1	1	1	1	1	1	R-308	Voltage Dividing Resistor	15,000 Ohms, 60 Watts	-631283E	RE13A372J	16		357	7608228-P196	R-308
1	1	1	1	1	1	1	1	1	1	1	1	1	1	R-309	I.A. Screen Resistor	Same as R-106	-63015E				358		
1	1	1	1	1	1	1	1	1	1	1	1	1	1	R-310	P.A. Grid Resistor	Same as R-109	-63011E				359		
1	1	1	1	1	1	1	1	1	1	1	1	1	1	R-311	P.A. Screen Resistor	Same as R-110	-63081F				360		
1	1	1	1	1	1	1	1	1	1	1	1	1	1	R-312	I.A. Filament Series Resistor	10 Ohms, 20 Watts	-63269E	RE13A372J	16		361	7608228-P206	R-312

RESTRICTED

7-31

RESTRICTED

Section VII

ELECTRICAL PARTS FOR MODEL TDE SERIES RADIO TRANSMITTING EQUIPMENTS (Continued)

Total Per Equipment											Symbol Desig.	Function	Description	Navy Type Number	Navy Spec. Number	Component Mfr.	Component Mfr. Desig.	Contractor's Item No.	Contractor's Drawing Number	All Symbol Designations Involved				
115 V.D.C. --TDE-3	230 V.D.C. --TDE-3	220/440/3/60 --TDE-3	115 V.D.C. --TDE-2	230 V.D.C. --TDE-2	220/440/3/60 --TDE-2	115 V.D.C. --TDE-1	230 V.D.C. --TDE-1	220/440/3/60 --TDE-1	208/3/60 --TDE-1	115/230/1/60 --TDE-1											115 V.D.C. --TDE	230 V.D.C. --TDE		
1	1	1	1	1	1	1	1	1	1	1	1	1	1	R-313	M.O. Filament Shunt Resistor	Same as R-303	-63703-2			362				
1	1	1	1	1	1	1	1	1	1	1	1	1	1	R-314	P.A. Suppressor Resistor	Same as R-303	-63703-2			363				
0	0	0	0	0	0	1	1	1	1	1	1	1	1	R-501	Field Rheostat	5000 Ohms Total Resistance, 650 Ohms Field Resistance, Max. Field Current 0.45 Amps., Min. Field Current 0.06 Amps. Max., Field Voltage 295 Volts, 2 Four Inch Plates Tapered to Give Equal Voltage and Decrease with Clockwise Rotation.	-632385		21	Do not use. For replacement. See Item 365, below.	364 7709844-P1	R-501		
1	1	1	1	1	1	0	0	0	0	0	0	0	0	R-501	Field Rheostat	7200 Ohms Total Resistance, +20% -10%, Field Resistance 2750 Ohms, Max. Field Current 0.20 Amps., Min. Field Current 0.055 Amps., Max. Field Voltage 550 Volts. Three 4 Inch Plates, Staggered Contacts, Resistance to Decrease with Clockwise Rotation	-632384		21		365 7711769-P1	R-501		
1	1	1	1	1	1	1	1	1	1	1	1	1	1	R-502	Voltage Divider Resistor	1000 Ohms, 60 Watts	-63076E	RE13A 372J	21		366 7609134-P112	R-502		
1	0	0	1	0	0	1	0	0	0	0	1	0	0	R-503	Starting Resistor	500 Ohms, 60 Watts	-63070E	RE13A 372J	21		367 7609134-P113	R-503		
1	1	1	1	1	1	1	1	1	1	1	1	1	1	R-504	Voltage Divider Resistor	3000 Ohms, 60 Watts	-63081E	RE13A 372J	21		368 7609134-P114	R-504		

RESTRICTED

RESTRICTED

ELECTRICAL PARTS FOR MODEL TDE SERIES RADIO TRANSMITTING EQUIPMENTS (Continued)

Total Per Equipment											Symbol Desig.	Function	Description	Navy Type Number	Navy Spec. Number	Component Mfr.	Component Mfr. Desig.	Contractor's Item No.	Contractor's Drawing Number	All Symbol Designations Involved						
115 V.D.C. --TDE-3	230 V.D.C. --TDE-3	220/440/3/60--TDE-3	115 V.D.C. --TDE-2	230 V.D.C. --TDE-2	220/440/3/60--TDE-2	115 V.D.C. --TDE-1	230 V.D.C. --TDE-1	220/440/3/60--TDE-1	208/3/60 --TDE-1	115/230/1/60--TDE-1																
0	1	0	0	1	0	0	1	0	0	0	0	0	1	0	R-505	Starting Resistor	2000 Ohms, 60 Watts	-63079E	RE13A372J	21		369	7609134-P115	R-505		
0	0	1	0	0	1	0	0	1	1	0	0	0	1	0	R-506	Starting Resistor	150 Ohms, 60 Watts	-63050E	RE13A372J	21		370	7609134-P116	R-506		
1	1	1	1	1	1	1	1	1	1	1	1	1	1	1	R-507	Rectox Resistor	150 Ohms, 10 Watts	-63814E	RE13A372J	21		371	7609134-P117	R-507		
1	1	1	1	1	1	1	1	1	1	1	1	1	1	1	RX-501	Rectox	1.35 Max. Amps., 12.8 Volts Apply 1 Coat of Varnish and Cadmium Plate All Connectors for Naval Service	-20331		1	S#1186496	372	7609134-P130	RX-501		
1	1	1	1	1	1	1	1	1	1	1	1	1	1	1	S-101A	M.O. Range Switch	2 Plates, 9 Positions, 1 Break Per Circuit, 10 Amps., 3000 Volts, Rotary Type			1		373	7607528-G4	S-101A		
1	1	1	1	1	1	1	1	1	1	1	1	1	1	1	S-101B	M.O. Range Switch	Part of S-101A					374			S-101B	
1	1	1	1	1	1	1	1	1	1	1	1	1	1	1		Insulation for S-101A and S-101B	Isolantite Including Contact			32		375	7408109-G3			
4	4	4	4	4	4	4	4	4	4	4	4	4	4	4		Insulation for S-101A	Isolantite	NS5W0108	C75.2-1943	32		376	7406683-P1			
4	4	4	4	4	4	4	4	4	4	4	4	4	4	4		Insulation for S-101B	Isolantite	-61483	RE13A317F RE61A215	32		377	7406683-P7			
2	2	2	2	2	2	2	2	2	2	2	2	2	2	2		Coupling for S-101A and S-101B	Isolantite			32		378	50-C-665-P2			
1	1	1	1	1	1	1	1	1	1	1	1	1	1	1		Brush and Arm	Spring Brushes			1		379	7707043-G2			
1	1	1	1	1	1	1	1	1	1	1	1	1	1	1		Brush and Arm	Spring Brushes			1		380	7707043-G4			
1	1	1	1	1	1	1	1	1	1	1	1	1	1	1		Spring for S-101A	Detent Spring			1		381	7810365-P1			
1	1	1	1	1	1	1	1	1	1	1	1	1	1	1		Nut—Special	Brass Nut			1		382	7406684-P4			
															S-102	Not Used										

RESTRICTED

7-33

RESTRICTED

Section VII

ELECTRICAL PARTS FOR MODEL TDE SERIES RADIO TRANSMITTING EQUIPMENTS (Continued)

Total Per Equipment													Symbol Desig.	Function	Description	Navy Type Number	Navy Spec. Number	Component Mfr.	Component Mfr. Desig.	Contractor's Item No.	Contractor's Drawing Number	All Symbol Designations Involved
115 V.D.C. --TDE-3	230 V.D.C. --TDE-3	220/440/3/60--TDE-3	115 V.D.C. --TDE-2	230 V.D.C. --TDE-2	220/440/3/60--TDE-2	115 V.D.C. --TDE-1	230 V.D.C. --TDE-1	220/440/3/60--TDE-1	208/3/60 --TDE-1	115/230/1/60--TDE-1	115 V.D.C. --TDE	230 V.D.C. --TDE										
														S-103	Not Used							
1	1	1	1	1	1	1	1	1	1	1	1	1	1	S-104A	P.A. Range Switch	Two Plates, 8 Positions, 36 Degree Between Positions, 10 Amps., 3000 Volts, Rotary Type		1		383	7608527-G1	S-104A
1	1	1	1	1	1	1	1	1	1	1	1	1	1	S-104B	P.A. Range Switch	Part of S-104A				384		S-104B
2	2	2	2	2	2	2	2	2	2	2	2	2	2		Insulation for S-104A and S-104B	Isolantite Including Contacts		32		385	7406841-G9	
4	4	4	4	4	4	4	4	4	4	4	4	4	4		Insulation for S-104A	Same as Item 376				386		
4	4	4	4	4	4	4	4	4	4	4	4	4	4		Insulation for S-104B	Same as Item 377				387		
1	1	1	1	1	1	1	1	1	1	1	1	1	1		Brush and Arm	Same as Item 379				388		
1	1	1	1	1	1	1	1	1	1	1	1	1	1		Brush and Arm	Same as Item 380				389		
2	2	2	2	2	2	2	2	2	2	2	2	2	2		Coupling for S-104A and S-104B	Same as Item 378				390		
1	1	1	1	1	1	1	1	1	1	1	1	1	1		Spring for S-140A	Same as Item 381				391		
														S-105	Not Used.							
1	1	1	1	1	1	1	1	1	1	1	1	1	1	S-106	Antenna Load Coil Switch	Single Pole, 11 Positions, One Break Per Circuit, 15 Kv. at 20 Amps., Rotary Type—Part of L-110		1		392	7608542-G1	S-106
2	2	2	2	2	2	2	2	2	2	2	2	2	2		Coupling for S-106	Insulated Coupling		32		393	7708646-G1	
1	1	1	1	1	1	1	1	1	1	1	1	1	1		Coupling	Insulator Coupling Isolantite		32		394	7809407-P2	
1	1	1	1	1	1	1	1	1	1	1	1	1	1	S-107A	I.F. Antenna Voltage Current Switch	2 Plates, 3 Positions, 72° Between Positions, Rotary Type		1		395	7608529-G1	S-107A, S-107B

RESTRICTED

RESTRICTED

ELECTRICAL PARTS FOR MODEL TDE SERIES RADIO TRANSMITTING EQUIPMENTS (Continued)

Total Per Equipment											Symbol Desig.	Function	Description	Navy Type Number	Navy Spec. Number	Component Mfr.	Component Mfr. Desig.	Contractor's Item No.	Contractor's Drawing Number	All Symbol Designations Involved
115 V.D.C. -TDE-3	230 V.D.C. -TDE-3	220/440/3/60-TDE-3	115 V.D.C. -TDE-2	230 V.D.C. -TDE-2	220/440/3/60-TDE-2	115 V.D.C. -TDE-1	230 V.D.C. -TDE-1	220/440/3/60-TDE-1	208/3/60-TDE-1	115/230/1/60-TDE-1										
1	1	1	1	1	1	1	1	1	1	1	S-107B	I.F. Antenna Voltage Current Switch	Part of S-107A					396		
2	2	2	2	2	2	2	2	2	2	2		Insulation for S-107A and S-107B	Isolantite Including Contacts			32		397 7708620-G7		
4	4	4	4	4	4	4	4	4	4	4		Insulation for S-107A	Isolantite	NS5W0112	C75.2-1943	32		398 7406683-P6		
4	4	4	4	4	4	4	4	4	4	4		Insulation for S-107B	Isolantite	-61484	RE61A215 RE13A317F	32		399 7406683-P8		
2	2	2	2	2	2	2	2	2	2	2		Coupling	Isolantite			32		400 50-C-660-P1		
1	1	1	1	1	1	1	1	1	1	1		Brush and Arm	Spring Brushes			1		401 7608693-G2		
1	1	1	1	1	1	1	1	1	1	1		Brush and Arm	Spring Brushes			1		402 7608693-G5		
1	1	1	1	1	1	1	1	1	1	1		Spring for S-107A	Same as Item 381					403		
											S-201	Not Used.								
1	1	1	1	1	1	1	1	1	1	1	S-202	CW-MCW Voice Switch	Single Pole, Three Positions, 4 Sections, One Break Per Circuit, 110 Volts at 1 Amp., Rotary Type			1		404 7406364-P4	S-202	
1	1	1	1	1	1	1	1	1	1	1	S-203	Remote Local Switch	4 Pole, Double Throw. Consist of 4 Sets of Single Pole, Double Throw Contacts, Lock in Both Positions, No Throw in Upper Position, Lever Type	-24104A		1		405 7707082-P6	S-203	
1	1	1	1	1	1	1	1	1	1	0	S-204	Start-Stop Switch	Four Wire, Double Pole, Single Throw, One Break Per Circuit, One Extreme Position, "On" Other Extreme Position "Off" No Center Position, Push Button Type			1 Spares 7707242-G8		406 7707242-G12	S-204	

RESTRICTED

7-35

RESTRICTED

Section VII

ELECTRICAL PARTS FOR MODEL TDE SERIES RADIO TRANSMITTING EQUIPMENTS (Continued)

Total Per Equipment														Symbol Desig.	Function	Description	Navy Type Number	Navy Spec. Number	Component Mfr.	Component Mfr. Desig.	Contractor's Item No.	Contractor's Drawing Number	All Symbol Designations Involved
115 V.D.C. -TDE-3	230 V.D.C. -TDE-3	220/440/3/60-TDE-3	115 V.D.C. -TDE-2	230 V.D.C. -TDE-2	220/440/3/60-TDE-2	115 V.D.C. -TDE-1	230 V.D.C. -TDE-1	220/440/3/60-TDE-1	208/3/60 -TDE-1	115/230/1/60-TDE-1	115 V.D.C. -TDE	230 V.D.C. -TDE	220/440/3/60-TDE										
0	0	0	0	0	0	0	0	0	0	0	1	1	1	S-204	Start-Stop Switch	Double Pole, Single Throw, One Break Per Circuit, One Extreme Position "On", Other Extreme Position "Off". No Center Position, Toggle Type			22	# 8851	407	7608229-P241	S-204
1	1	1	1	1	1	1	1	1	1	1	1	1	1	S-205	Interlock Switch	Single Circuit, Double Break 1 Amp., at 500 Volts, Interlock Type	-24067		1	S# 867378	408	7608229-P242	S-205, S-501
1	1	1	1	1	1	1	1	1	1	1	1	1	1		Spacer	Micarta Plate			1		409	7809890-P1	
1	1	1	1	1	1	1	1	1	1	1	1	0	0	S-206	Start-Stop Switch	6 Wire			1	Spare 7707242-G7	410	7707242-G11	S-206
1	1	1	1	1	1	1	1	1	1	1	1	1	1	S-207	Tune Operate Switch	2 Plates, 3 Positions, 72° Between Positions, Rotary Type			1		411	7608528-G1	S-207
2	2	2	2	2	2	2	2	2	2	2	2	2	2		Switch Plate for S-207	Isolantite Including Contact			32		412	7708620-G6	
4	4	4	4	4	4	4	4	4	4	4	4	4	4		Insulator	Same as Item 377					413		
1	1	1	1	1	1	1	1	1	1	1	1	1	1		Brush and Arm	Same as Item 379					414		
1	1	1	1	1	1	1	1	1	1	1	1	1	1		Spring	Same as Item 381					415		
2	2	2	2	2	2	2	2	2	2	2	2	2	2		Coupling	Same as Item 378					416		
1	1	1	1	1	1	1	1	1	1	1	1	1	1	S-208	Test Key Switch	Single Pole, Double Throw One Break Per Circuit, 115 Volts at 10 Amps. A.C., 250 Volts at 5 Amps. A.C., Leaf Actuated Snap Switch			23		417	7608229-P244	S-208
1	1	1	1	1	1	1	1	1	1	1	1	1	1	S-209	Link Switch	Connecting Link			1		418	7708632-G1	S-209, S-210, S-211, S-212
1	1	1	1	1	1	1	1	1	1	1	1	1	1	S-210	Link Switch	Part of S-209					419		

RESTRICTED

RESTRICTED

ELECTRICAL PARTS FOR MODEL TDE SERIES RADIO TRANSMITTING EQUIPMENTS (Continued)

Total Per Equipment												Symbol Desig.	Function	Description	Navy Type Number	Navy Spec. Number	Component Mfr.	Component Mfr. Desig.	Contractor's Item No.	Contractor's Drawing Number	All Symbol Designations Involved		
115 V.D.C. --TDE-3	230 V.D.C. --TDE-3	220/440/3/60 --TDE-3	115 V.D.C. --TDE-2	230 V.D.C. --TDE-2	220/440/3/60 --TDE-2	115 V.D.C. --TDE-1	230 V.D.C. --TDE-1	220/440/3/60 --TDE-1	208/3/60 --TDE-1	115/230/1/60 --TDE-1	115 V.D.C. --TDE											230 V.D.C. --TDE	
1	1	1	1	1	1	1	1	1	1	1	1	1	1	S-211	Link Switch	Part of S-209				420			
1	1	1	1	1	1	1	1	1	1	1	1	1	1	S-212	Link Switch	Part of S-209				421			
1	1	1	1	1	1	1	1	1	1	1	1	1	1	S-213	Antenna Change Over Switch	Single Pole, Two Positions, One Break Per Circuit, 15 Kv. at 20 Amps., Rotary Type Part of L-110			1	422	7608229-P236	S-213	
1	1	1	1	1	1	1	1	1	1	1	1	1	1	S-214	H.F. I.F. Switch	3 Pole, Two Position, One Break Per Circuit, 5000 Volt at 10 Amps., Rotary Type			1	423	7608544-G1	S-214	
1	1	1	1	1	1	1	1	1	1	1	1	1	1	S-215A	P.A. Filament Change Over Switch	Single Pole, Two Positions, One Break Per Circuit, 10 Amps. at 3000 Volts, Toggle Type	-24095A		24	* 8929QA	424	7608229-P238	S-215A, S-215B, S-1301
1	1	1	1	1	1	1	1	1	1	1	1	1	1	S-215B	Exciter Power Change Over Switch	Same as S-215A	-24095A				425		
1	1	1	1	1	1	1	1	1	1	1	1	1	1	S-301A	H.F. M.O. Range Switch	2 Plates, 5 Positions, One Break Per Circuit, 10 Amps. at 3000 Volts, Rotary Type			1	426	7607528-G3	S-301A	
1	1	1	1	1	1	1	1	1	1	1	1	1	1	S-301B	H.F. M.O. Range Switch	Part of S-301A					427		S-301B
2	2	2	2	2	2	2	2	2	2	2	2	2	2		Insulation for S-301B	Isolantite, Including Contact				32	428	7408109-G2	
4	4	4	4	4	4	4	4	4	4	4	4	4	4		Spacers	Same as Item 376						429	
2	2	2	2	2	2	2	2	2	2	2	2	2	2		Coupling	Same as Item 378						430	
4	4	4	4	4	4	4	4	4	4	4	4	4	4		Spacers	Same as Item 377						431	
1	1	1	1	1	1	1	1	1	1	1	1	1	1		Brush and Arm	Same as Item 379						432	

RESTRICTED

7-37

RESTRICTED

Section VII

ELECTRICAL PARTS FOR MODEL TDE SERIES RADIO TRANSMITTING EQUIPMENTS (Continued)

Total Per Equipment												Symbol Desig.	Function	Description	Navy Type Number	Navy Spec. Number	Component Mfr.	Component Mfr. Desig.	Contractor's Item No.	Contractor's Drawing Number	All Symbol Designations Involved
115 V.D.C. --TDE-3	233 V.D.C. --TDE-3	221/440/3/60--TDE-3	115 V.D.C. --TDE-2	230 V.D.C. --TDE-2	220/440/3/60--TDE-2	115 V.D.C. --TDE-1	230 V.D.C. --TDE-1	220/440/3/60--TDE-1	115 V.D.C. --TDE-1	230 V.D.C. --TDE-1	220/440/3/60--TDE-1										
1	1	1	1	1	1	1	1	1	1	1	1		Brush and Arm	Same as Item 380				433			
1	1	1	1	1	1	1	1	1	1	1	1		Spring	Same as Item 381				434			
1	1	1	1	1	1	1	1	1	1	1	1		Nut—Special	Same as Item 382				435			
1	1	1	1	1	1	1	1	1	1	1	1	S-302A	H.F. Doubler Range Switch	2 Plates, 4 Positions, One Break Per Circuit, 10 Amps. at 3000 Volts, Rotary Type	1		436	7607528-G2	S-302A		
1	1	1	1	1	1	1	1	1	1	1	1	S-302B	H.F. Doubler Range Switch	Part of S-302A			437		S-302B		
2	2	2	2	2	2	2	2	2	2	2	2		Insulation for S-302B	Isolantite Including Contact	32		438	7408109-G1			
4	4	4	4	4	4	4	4	4	4	4	4		Spacers	Same as Item 376			439				
4	4	4	4	4	4	4	4	4	4	4	4		Spacers	Same as Item 377			440				
2	2	2	2	2	2	2	2	2	2	2	2		Coupling	Same as Item 378			441				
1	1	1	1	1	1	1	1	1	1	1	1		Brush and Arm	Same as Item 379			442				
1	1	1	1	1	1	1	1	1	1	1	1		Brush and Arm	Same as Item 380			443				
1	1	1	1	1	1	1	1	1	1	1	1		Spring	Same as Item 381			444				
1	1	1	1	1	1	1	1	1	1	1	1		Nut—Special	Same as Item 382			445				
1	1	1	1	1	1	1	1	1	1	1	1	S-303	H.F. I.A. Range Switch	1 Plate, 6 Positions, with 36° Between Positions, Rotary Type	1		446	7608527-G2	S-303		
1	1	1	1	1	1	1	1	1	1	1	1		Insulator	Isolantite Including Contact	32		447	7708620-G5			
4	4	4	4	4	4	4	4	4	4	4	4		Spacers	Same as Item 377			448				
1	1	1	1	1	1	1	1	1	1	1	1		Coupling	Same as Item 378			449				

RESTRICTED

RESTRICTED

ELECTRICAL PARTS FOR MODEL TDE SERIES RADIO TRANSMITTING EQUIPMENTS (Continued)

Total Per Equipment												Symbol Desig.	Function	Description	Navy Type Number	Navy Spec. Number	Component Mfr.	Component Mfr. Desig.	Contractor's Item No.	Contractor's Drawing Number	All Symbol Designations Involved
115 V.D.C. —TDE-3	230 V.D.C. —TDE-3	220/440/3/60—TDE-3	115 V.D.C. —TDE-2	230 V.D.C. —TDE-2	220/440/3/60—TDE-2	115 V.D.C. —TDE-1	230 V.D.C. —TDE-1	220/440/3/60—TDE-1	208/3/60 —TDE-1	115/230/1/60—TDE-1	230 V.D.C. —TDE										
1	1	1	1	1	1	1	1	1	1	1	1	1		Brush and Arm	Same as Item 379			450			
1	1	1	1	1	1	1	1	1	1	1	1	1		Spring	Same as Item 381			451			
1	1	1	1	1	1	1	1	1	1	1	1	1		Nut—Special	Same as Item 382			452			
1	1	1	1	1	1	1	1	1	1	1	1	1	S-304A	H.F. Voltage Current Switch	1 Plate, 2 Positions with 72° Between Positions, Rotary Type	1		453	7608526-G1	S-304A	
1	1	1	1	1	1	1	1	1	1	1	1	1	S-304B	H.F. Voltage Current	1 Plate, 2 Positions with 72° Between Positions, Rotary Type	1		454	7608526-G2	S-304B	
1	1	1	1	1	1	1	1	1	1	1	1	1		Insulation	Isolantite, Including Contacts	32		455	7708620-G1		
1	1	1	1	1	1	1	1	1	1	1	1	1		Insulation	Isolantite, Including Contacts	32		456	7708620-G2		
4	4	4	4	4	4	4	4	4	4	4	4	4		Spacers	Same as Item 377			457			
1	1	1	1	1	1	1	1	1	1	1	1	1		Coupling	Same as Item 378			458			
2	2	2	2	2	2	2	2	2	2	2	2	2		Coupling	Same as Item 400			459			
1	1	1	1	1	1	1	1	1	1	1	1	1		Brush and Arm	Same as Item 379			460			
1	1	1	1	1	1	1	1	1	1	1	1	1		Brush and Arm	Spring Brush	1		461	7708648-G1		
1	1	1	1	1	1	1	1	1	1	1	1	1		Spring	Same as Item 381			462			
1	1	1	1	1	1	1	1	1	1	1	1	1		Nut—Special	Same as Item 382			463			
													S-305 to S-306	Not Used							
1	1	1	1	1	1	1	1	1	1	1	1	1	S-307A	H.F. P.A. Range Switch	2 Plates, 2 Positions, 72° Between Positions, Rotary Type	1		464	7608526-G5	S-307A, S-307B	

RESTRICTED

7-39

RESTRICTED

Section VII

ELECTRICAL PARTS FOR MODEL TDE SERIES RADIO TRANSMITTING EQUIPMENTS (Continued)

Total Per Equipment													Symbol Desig.	Function	Description	Navy Type Number	Navy Spec. Number	Component Mfr.	Component Mfr. Desig.	Contractor's Item No.	Contractor's Drawing Number	All Symbol Designations Involved
115 V.D.C. --TDE-3	230 V.D.C. --TDE-3	220/440/3/60--TDE-3	115 V.D.C. --TDE-2	230 V.D.C. --TDE-2	220/440/3/60--TDE-2	115 V.D.C. --TDE-1	230 V.D.C. --TDE-1	220/440/3/60--TDE-1	208/3/60 --TDE-1	115/230/1/60--TDE-1	115 V.D.C. --TDE	230 V.D.C. --TDE										
1	1	1	1	1	1	1	1	1	1	1	1	1	1	S-307B	H.F. P.A. Range Switch	Part of S-307A				465		
1	1	1	1	1	1	1	1	1	1	1	1	1	1		Insulation	Isolantite Including Contacts		32		466	7708620-G3	
1	1	1	1	1	1	1	1	1	1	1	1	1	1		Insulation	Isolantite Including Contacts		1		467	7708620-G4	
1	1	1	1	1	1	1	1	1	1	1	1	1	1		Brush and Arm	Same as Item 379				468		
1	1	1	1	1	1	1	1	1	1	1	1	1	1		Brush and Arm	Spring Brush				469	7708648-G2	
2	2	2	2	2	2	2	2	2	2	2	2	2	2		Coupling	Same as Item 378				470		
4	4	4	4	4	4	4	4	4	4	4	4	4	4		Spacer	Same as Item 376				471		
1	1	1	1	1	1	1	1	1	1	1	1	1	1	S-501	Interlock	Same as S-205	-24067			472		
1	1	1	1	1	1	1	1	1	1	1	1	1	1	S-502	Link Switch	Connecting Link		1		473	7708938-G1	S-502 to S-511, Incl.
1	1	1	1	1	1	1	1	1	1	1	1	1	1	S-503	Link Switch	Part of S-502				474		
1	1	1	1	1	1	1	1	1	1	1	1	1	1	S-504	Link Switch	Part of S-502				475		
1	1	1	1	1	1	1	1	1	1	1	1	1	1	S-505	Link Switch	Part of S-502				476		
1	1	1	1	1	1	1	1	1	1	1	1	1	1	S-506	Link Switch	Part of S-502				477		
1	1	1	1	1	1	1	1	1	1	1	1	1	1	S-507	Link Switch	Part of S-502				478		
1	1	1	1	1	1	1	1	1	1	1	1	1	1	S-508	Link Switch	Part of S-502				479		
1	1	1	1	1	1	1	1	1	1	1	1	1	1	S-509	Link Switch	Part of S-502				480		
1	1	1	1	1	1	1	1	1	1	1	1	1	1	S-510	Link Switch	Part of S-502				481		
1	1	1	1	1	1	1	1	1	1	1	1	1	1	S-511	Link Switch	Part of S-502				482		

ELECTRICAL PARTS FOR MODEL TDE SERIES RADIO TRANSMITTING EQUIPMENTS (Continued)

Total Per Equipment												Symbol Desig.	Function	Description	Navy Type Number	Navy Spec. Number	Component Mfr.	Component Mfr. Desig.	Contractor's Item No.	Contractor's Drawing Number	All Symbol Designations Involved		
115 V.D.C. —TDE-3	230 V.D.C. —TDE-3	220/440/3/60 —TDE-3	115 V.D.C. —TDE-2	230 V.D.C. —TDE-2	220/440/3/60 —TDE-2	115 V.D.C. —TDE-1	230 V.D.C. —TDE-1	220/440/3/60 —TDE-1	208/3/60 —TDE-1	115/230/1/60 —TDE-1	115 V.D.C. —TDE											230 V.D.C. —TDE	220/440/3/60 —TDE
0	0	0	0	0	0	0	0	0	0	1	0	0	0	S-641	Stationary—Switch	Single Pole, Single Throw, One Break Per Circuit.	-24389		1	*887441	483	22-A-156	S-641
0	0	0	0	0	0	0	0	0	0	1	0	0	0	S-642	Rotating Switch	Part of S-641					484		S-642
0	0	0	0	0	0	0	0	0	0	0	1	1	1	S-1301	Start—Stop Switch	Same as S-215A	-24095A				485		
1	1	1	1	1	1	1	1	1	1	1	0	0	0	S-1302	Start—Stop Switch	4-Wire, Single Pole, Single Throw, 125 Volts, 5 Amps., Toggle Type			22	*8210	486	7608229-P262	S-1302
1	1	1	1	1	1	1	1	1	1	1	0	0	0	S-1303	Start—Stop Switch	6-Wire, Single Pole, Double Throw, 125 Volts, 5 Amps., Toggle Type			22	*8212	487	7608229-P263	S-1303
1	1	1	1	1	1	1	1	1	1	1	1	1	1	T-201	Filament Transformer	106 V.A., 50 to 60 Cycles Wnd Turns Size Res. Volts Amps Pri 1 180 22E 2.8 100 1.2 2 180 22E 2.0 100 1.2 Sec 1 20 14E .045 10.5 5. 2 14 18E .081 7.5 2.15 3 14 18E .081 7.5 1.25 4 29 18E .210 15.5 1.6 5 25 22E .470 13.5 .2 Test: 2000 Volts, 60 Cycles	-30928		14		488	L-382629	T-201
1	1	1	1	1	1	1	1	1	1	1	1	1	1	T-202	Microphone Transformer	0.09 Amps. D.C., 300 to 3000 Cycles, Ratio 1 to 30 Wnd Turns Size Res. Pri 1 200 30E 7.8 2 200 30E 8.7 3 145 30E 5.7 Sec 1 3000 5 38E 768 2 3000 38E 767 Test: 1500 Volts, 60 Cycles	-30854		14		489	L-382619	T-202

RESTRICTED

7-41

RESTRICTED

Section VII

ELECTRICAL PARTS FOR MODEL TDE SERIES RADIO TRANSMITTING EQUIPMENTS (Continued)

Total Per Equipment													Symbol Desig.	Function	Description	Navy Type Number	Navy Spec. Number	Component Mfr.	Component Mfr. Desig.	Contractor's Item No.	Contractor's Drawing Number	All Symbol Designations Involved																																																
115 V.D.C. —TDE-3	230 V.D.C. —TDE-3	220/440/3/60—TDE-3	115 V.D.C. —TDE-2	230 V.D.C. —TDE-2	220/440/3/60—TDE-2	115 V.D.C. —TDE-1	230 V.D.C. —TDE-1	220/440/3/60—TDE-1	208/3/60 —TDE-1	115/230/1/60—TDE-1	115 V.D.C. —TDE	230 V.D.C. —TDE																																																										
1	1	1	1	1	1	1	1	1	1	1	1	1	T-203	Modulation Trans- former	Ratio 1 to 2, 300 to 3000 Cycles <table border="1"> <thead> <tr> <th>Wnd Pri</th> <th>Turns</th> <th>Size</th> <th>Res.</th> </tr> </thead> <tbody> <tr> <td>1</td> <td>3500</td> <td>40E</td> <td>1050</td> </tr> <tr> <th>Sec</th> <td></td> <td></td> <td></td> </tr> <tr> <td>1</td> <td>7000</td> <td>40E</td> <td>2740</td> </tr> <tr> <td>2</td> <td>1050</td> <td>36E</td> <td>92</td> </tr> </tbody> </table> Test: 1500 Volts, 60 Cycles	Wnd Pri	Turns	Size	Res.	1	3500	40E	1050	Sec				1	7000	40E	2740	2	1050	36E	92	-30855		14		490	L-382620	T-203																												
Wnd Pri	Turns	Size	Res.																																																																			
1	3500	40E	1050																																																																			
Sec																																																																						
1	7000	40E	2740																																																																			
2	1050	36E	92																																																																			
1	1	1	1	1	1	1	1	1	1	1	1	1	T-501	Rectifier Transformer	50 V.A., 50 to 60 Cycles <table border="1"> <thead> <tr> <th>Wnd Pri</th> <th>Turns</th> <th>Size</th> <th>Res.</th> <th>Volts</th> <th>Amps</th> </tr> </thead> <tbody> <tr> <td>1</td> <td>290</td> <td>26E</td> <td>10</td> <td>100</td> <td>.455</td> </tr> <tr> <td>2</td> <td>290</td> <td>26E</td> <td>10.5</td> <td>100</td> <td>.455</td> </tr> <tr> <th>Sec</th> <td></td> <td></td> <td></td> <td></td> <td></td> </tr> <tr> <td>1</td> <td>14</td> <td>16E</td> <td>.045</td> <td>5</td> <td>3</td> </tr> <tr> <td>2</td> <td>388</td> <td>29E</td> <td>24</td> <td>140</td> <td>.075</td> </tr> <tr> <td>3</td> <td>388</td> <td>29E</td> <td>25</td> <td>140</td> <td>.075</td> </tr> <tr> <td>4</td> <td>58</td> <td>20E</td> <td>.57</td> <td>20.6</td> <td>1.2</td> </tr> </tbody> </table> Test: 1500 Volts, 60 Cycles	Wnd Pri	Turns	Size	Res.	Volts	Amps	1	290	26E	10	100	.455	2	290	26E	10.5	100	.455	Sec						1	14	16E	.045	5	3	2	388	29E	24	140	.075	3	388	29E	25	140	.075	4	58	20E	.57	20.6	1.2	-30929		14		491	L-382624	T-501
Wnd Pri	Turns	Size	Res.	Volts	Amps																																																																	
1	290	26E	10	100	.455																																																																	
2	290	26E	10.5	100	.455																																																																	
Sec																																																																						
1	14	16E	.045	5	3																																																																	
2	388	29E	24	140	.075																																																																	
3	388	29E	25	140	.075																																																																	
4	58	20E	.57	20.6	1.2																																																																	
1	1	1	1	1	1	1	1	1	1	1	1	1	T-502	Power Transformer	50 V.A., 50 to 60 Cycles <table border="1"> <thead> <tr> <th>Wnd Pri</th> <th>Turns</th> <th>Size</th> <th>Res.</th> <th>Volts</th> <th>Amps</th> </tr> </thead> <tbody> <tr> <td>1</td> <td>1300</td> <td>29E</td> <td>70</td> <td>220</td> <td>0.13</td> </tr> <tr> <td>2</td> <td>1500</td> <td>29E</td> <td>70</td> <td>220</td> <td>0.13</td> </tr> <tr> <th>Sec</th> <td></td> <td></td> <td></td> <td></td> <td></td> </tr> <tr> <td>1</td> <td>700</td> <td>26E</td> <td>14</td> <td>110</td> <td>0.21</td> </tr> <tr> <td>2</td> <td>700</td> <td>26E</td> <td>14</td> <td>110</td> <td>0.21</td> </tr> </tbody> </table> Test: 2000 Volts, 60 Cycles	Wnd Pri	Turns	Size	Res.	Volts	Amps	1	1300	29E	70	220	0.13	2	1500	29E	70	220	0.13	Sec						1	700	26E	14	110	0.21	2	700	26E	14	110	0.21	-30926		14		492	L-386919	T-502												
Wnd Pri	Turns	Size	Res.	Volts	Amps																																																																	
1	1300	29E	70	220	0.13																																																																	
2	1500	29E	70	220	0.13																																																																	
Sec																																																																						
1	700	26E	14	110	0.21																																																																	
2	700	26E	14	110	0.21																																																																	
1	1	1	1	1	1	1	1	1	1	1	1	1	T-503	Power Transformer	190 V.A., 50 to 60 Cycles <table border="1"> <thead> <tr> <th>Wnd Pri</th> <th>Turns</th> <th>Size</th> <th>Res.</th> <th>Volts</th> <th>Amps</th> </tr> </thead> <tbody> <tr> <td>1</td> <td>475</td> <td>24E</td> <td>10.5</td> <td>220</td> <td>0.44</td> </tr> <tr> <td>2</td> <td>475</td> <td>24E</td> <td>10.5</td> <td>220</td> <td>0.44</td> </tr> <tr> <th>Sec</th> <td></td> <td></td> <td></td> <td></td> <td></td> </tr> <tr> <td>1</td> <td>250</td> <td>22E</td> <td>2.75</td> <td>110</td> <td>0.8</td> </tr> <tr> <td>2</td> <td>250</td> <td>22E</td> <td>2.75</td> <td>110</td> <td>0.8</td> </tr> </tbody> </table> Test: 2000 Volts, 60 Cycles	Wnd Pri	Turns	Size	Res.	Volts	Amps	1	475	24E	10.5	220	0.44	2	475	24E	10.5	220	0.44	Sec						1	250	22E	2.75	110	0.8	2	250	22E	2.75	110	0.8	-30927		14		493	L-386915	T-503												
Wnd Pri	Turns	Size	Res.	Volts	Amps																																																																	
1	475	24E	10.5	220	0.44																																																																	
2	475	24E	10.5	220	0.44																																																																	
Sec																																																																						
1	250	22E	2.75	110	0.8																																																																	
2	250	22E	2.75	110	0.8																																																																	

ELECTRICAL PARTS FOR MODEL TDE SERIES RADIO TRANSMITTING EQUIPMENTS (Continued)

Total Per Equipment													Symbol Desig.	Function	Description	Navy Type Number	Navy Spec. Number	Component Mfr.	Component Mfr. Desig.	Contractor's Item No.	Contractor's Drawing Number	All Symbol Designations Involved	
115 V.D.C. —TDE-3	230 V.D.C. —TDE-3	220/440/3/60—TDE-3	115 V.D.C. —TDE-2	230 V.D.C. —TDE-2	220/440/3/60—TDE-2	115 V.D.C. —TDE-1	230 V.D.C. —TDE-1	220/440/3/60—TDE-1	208/3/60 —TDE-1	115/230/1/60—TDE-1	115 V.D.C. —TDE	230 V.D.C. —TDE											220/440/3/60—TDE
0	0	0	0	0	0	0	0	0	1	0	0	0	0	T-701	Auto-Transformer, Three Phase	1400 V.A., 208/220 Volts, 60 Cycles Wnd Term Wire Size DC Res. Main 756 #27 28.6 Transf. 44 #16 0.128 Transf. 667 #27 21.6 Transf. 38 #16 0.1 .32 Amps. in Common Winding 3.58 Amps. in Winding Extensions	-301145		1	R-1334	494	DL-7502448 Sheet 3, Line 24	T-701
1	1	1	1	1	1	1	1	1	1	1	1	1	1	V-101	M.O. Tube	Vacuum Tube (Transmitter Triode) R.F. Oscillator Triode, Glass Base, Medium 4 Pin Bayonet, Molded, Heater Current 1.25 Amps. at at 7.5 V.A.C. or V.D.C.	-801	RE13A600D	25	* 801	495	7608229-P269	V-101, V-201
1	1	1	1	1	1	1	1	1	1	1	1	1	1	V-102	I.F. I.A. Tube	Vacuum Tube (Transmitter Beam) R.F. Beam Power Amplifier—Glass Base, Medium 5 Pin Bayonet, Molded, Small Metal Cap. Heater Current 0.9 Amps. at 6.3 V.A.C. or V.D.C.	-807	RE13A600D	20	* 807	496	7608229-P270	V-102, V-302
1	1	1	1	1	1	1	1	1	1	1	1	1	1	V-103	I.F. P.A. Tube	Vacuum Tube (Transmitter Pentode R.F. Amplifier Pentode—Glass Base, Giant 5 Pin Bayonet, Molded, Medium Cap. Heater Current 5 Amps. at 10 V.A.C. or V.D.C.	-803	RE13A600D	20	* 803	497	7608229-P271	V-103, V-303
1	1	1	1	1	1	1	1	1	1	1	1	1	1	V-201	Audio Tube	Same as V-101	-801				498		

RESTRICTED

7-43

RESTRICTED

Section VII

ELECTRICAL PARTS FOR MODEL TDE SERIES RADIO TRANSMITTING EQUIPMENTS (Continued)

Total Per Equipment											Symbol Desig.	Function	Description	Navy Type Number	Navy Spec. Number	Component Mfr.	Component Mfr. Desig.	Contractor's Item No.	Contractor's Drawing Number	All Symbol Designations Involved						
115 V.D.C. -TDE-3	230 V.D.C. -TDE-3	220/440/3/60-TDE-3	115 V.D.C. -TDE-2	230 V.D.C. -TDE-2	220/440/3/60-TDE-2	115 V.D.C. -TDE-1	230 V.D.C. -TDE-1	220/440/3/60-TDE-1	208/3/60 -TDE-1	115/230/1/60-TDE-1											115 V.D.C. -TDE	230 V.D.C. -TDE	220/440/3/60-TDE			
1	1	1	1	1	1	1	1	1	1	1	1	1	1	V-301	H.F. M.O. Tube	Vacuum Tube (Transmitting Pentode) R.F. Oscillator Pentode. Glass Base, Medium 7 Pin Bayonet. Molded, Small Metal Cap. Heater Current 0.7 Amps. at 12.6 V.A.C. or V.D.C.	-837	RE13A600D	25	# 837	499	7608229-P273	V-301			
1	1	1	1	1	1	1	1	1	1	1	1	1	1	V-302	H.F. I.A. Tube	Same as V-102	-807					500				
1	1	1	1	1	1	1	1	1	1	1	1	1	1	V-303	H.F. P.A. Tube	Same as V-103	-803						501			
1	1	1	1	1	1	1	1	1	1	1	1	1	1	V-501	Rectifier Tube	Vacuum Tube (Full Wave Rectifier) Full Wave High Vacuum Rectifier. Glass Base, Medium Octal 5 Pin. Molded, Heater Current 3 Amps. at 5 V.A.C.	-5U4G	RE13A600D	25	# 5U4G	502	7609134-P139	V-501			
1	1	1	1	1	1	1	1	1	1	1	1	1	1	X-101	M.O. Tube Socket	Vacuum Tube Socket, Transmitting Type, 4 Contacts, Wafer Type with Bayonet Pin Slot	-49327			26		503	7706776-P2	X-101, X-201		
1	1	1	1	1	1	1	1	1	1	1	1	1	1	X-102	I.F. I.A. Tube Socket	Vacuum Tube Socket, Transmitting Type, 5 Contacts, Wafer Type with Bayonet Pin Slot	-49328			26		504	7706776-P3	X-102, X-302		
1	1	1	1	1	1	1	1	1	1	1	1	1	1	X-103	I.F. P.A. Tube Socket	Vacuum Tube Socket, Transmitting Type, 5 Contacts, Jumbo Wafer Type with Bayonet Pin Slot	-38356			1		505	7707434-G3	X-103, X-303		
1	1	1	1	1	1	1	1	1	1	1	1	1	1	X-201	Audio Tube Socket	Same as X-101	-49327						506			

RESTRICTED

RESTRICTED

ELECTRICAL PARTS FOR MODEL TDE SERIES RADIO TRANSMITTING EQUIPMENTS (Continued)

Total Per Equipment													Symbol Desig.	Function	Description	Navy Type Number	Navy Spec. Number	Component Mfr.	Component Mfr. Desig.	Contractor's Item No.	Contractor's Drawing Number	All Symbol Designations Involved	
115 V.D.C. --TDE-3	230 V.D.C. --TDE-3	220/440/3/60--TDE-3	115 V.D.C. --TDE-2	230 V.D.C. --TDE-2	220/440/3/60--TDE-2	115 V.D.C. --TDE-1	230 V.D.C. --TDE-1	220/440/3/60--TDE-1	208/3/60 --TDE-1	115/230/1/60--TDE-1	115 V.D.C. --TDE	230 V.D.C. --TDE											220/440/3/60--TDE
1	1	1	1	1	1	1	1	1	1	1	1	1	1	X-301	I.F. M.O. Tube Socket	Vacuum Tube Socket, Transmitting Type, 7 Contacts, Large, Wafer Type with Bayonet Pin Slot	-49366				507	7706776-P5	X-301
1	1	1	1	1	1	1	1	1	1	1	1	1	1	X-302	H.F. I.A. Tube Socket	Same as X-102	-49328				508		
1	1	1	1	1	1	1	1	1	1	1	1	1	1	X-303	H.F. P.A. Tube Socket	Same as X-103	-38356				509		
1	1	1	1	1	1	1	1	1	1	1	1	1	1	X-501	Rectifier Tube Socket	Vacuum Tube Socket, Transmitting Type, 8 Contacts, Medium Octal Base, Wafer Type with Bayonet Pin Slot	-49367	RE49A314	27	Part of T-501	510		X-501
1	1	1	1	1	1	1	1	1	1	1	1	1	1	TS-1	Terminal Strip	Micarta Strip 7 $\frac{1}{16}$ " x $\frac{1}{2}$ " of $\frac{1}{16}$ " Tk. 12 Numbers in the Following Sequence: 1, 2, 3, 4, 5, 6, 7, 8, 20, 21, 22, 23			1		511	7608472-G2	TS-1
1	1	1	1	1	1	1	1	1	1	1	1	1	1	TS-2	Terminal Strip	Micarta Strip 7 $\frac{1}{16}$ " x $\frac{1}{2}$ " of $\frac{1}{16}$ " Tk. 12 Numbers in the Following Sequence 18, 14, 9, 19, 16, 10, 15, 33, 13, 24, 25, 26			1		512	7608472-G1	TS-2
1	1	1	1	1	1	1	1	1	1	1	1	1	1	T-3	Terminal Strip	Molded with Screw Terminals, Spacers $\frac{3}{8}$ " O.D. x $\frac{3}{16}$ " I.D. x $\frac{9}{32}$ " Lg. Marker Strip 10 $\frac{1}{2}$ " x $\frac{1}{2}$ " of $\frac{1}{16}$ " Tk. with White Nos. Stamped 1, 2, 3, 4, 5, 6, 7, 8, 20, 21, 22, 23, 27, 28, 29, 30, 31			1		513	7708628-G2	TS-3
1	1	1	1	1	1	1	1	1	1	1	1	1	1	TS-4	Terminal Strip	Molded with Screw Terminals, Spacers $\frac{3}{8}$ " O.D. x $\frac{3}{16}$ " I.D. x $\frac{9}{32}$ " Lg. Marker Strip 7 $\frac{1}{16}$ " x $\frac{1}{2}$ " of $\frac{1}{16}$ " Tk. with White Nos. Stamped 15, 18, 9, 10, 13, 14, 19, 24, 16, 17, 25, 26			1		514	7708628-G1	TS-4

RESTRICTED

7-45

RESTRICTED

Section VII

ELECTRICAL PARTS FOR MODEL TDE SERIES RADIO TRANSMITTING EQUIPMENTS (Continued)

7-46

RESTRICTED

Total Per Equipment												Symbol Desig.	Function	Description	Navy Type Number	Navy Spec. Number	Component Mfr.	Component Mfr. Desig.	Contractor's Item No.	Contractor's Drawing Number	All Symbol Designations Involved
115 V.D.C. -TDE-3	230 V.D.C. -TDE-3	220/440/3/60-TDE-3	115 V.D.C. -TDE-2	230 V.D.C. -TDE-2	220/440/3/60-TDE-2	115 V.D.C. -TDE-1	230 V.D.C. -TDE-1	220/440/3/60-TDE-1	208/3/60 -TDE-1	115/230/1/60-TDE-1	115 V.D.C. -TDE										
1	1	1	1	1	1	1	1	1	1	1	1	1	1	TS-5	Terminal Strip	Molded with Screw Terminals Spacers $\frac{3}{8}$ " O.D. x $\frac{3}{16}$ " I.D. x $\frac{3}{2}$ " Lg. Marker Strip $3\frac{3}{8}$ " x $\frac{1}{2}$ " x $\frac{1}{16}$ " Tk. with White Nos. Stamped 1, 2, 3, 4		1	515 7708628-G3	TS-5	
1	1	1	1	1	1	1	1	1	1	1	1	1	1	TS-6	Terminal Strip	Molded with Screw Terminals Spacers $\frac{3}{8}$ " O.D. x $\frac{3}{16}$ " I.D. x $\frac{3}{2}$ " Lg. Marker Strip $4\frac{7}{8}$ " x $\frac{1}{2}$ " of $\frac{1}{16}$ " Tk. with White Nos. Stamped 5, 6, 7, 8, 9, 10, 11		1	516 7708628-G4	TS-6	
1	1	1	1	1	1	1	1	1	1	1	1	1	1	TS-7	Terminal Strip	Molded with Screw Terminals Spacers $\frac{3}{8}$ " O.D. x $\frac{3}{16}$ " I.D. x $\frac{3}{2}$ " Lg. Marker Strip 6" x $\frac{1}{2}$ " of $\frac{1}{16}$ " Tk. with White Nos. Stamped 1, 2, 3, 4, 5, 6, 7, 8, 9		1	517 7708628-G5	TS-7	
1	1	1	1	1	1	1	1	1	1	1	1	1	1	TS-8	Terminal Strip	Micarta Strip $2\frac{5}{8}$ " x $\frac{1}{2}$ " of $\frac{1}{16}$ " Tk. Stamped in White Letters "HV, LV-A, LV-F"		1	518 7608472-G3	TS-8	
1	1	1	1	1	1	1	1	1	1	1	1	1	1	TS-9	Terminal Strip	Micarta Strip $3\frac{3}{4}$ " x $\frac{1}{2}$ " of $\frac{1}{16}$ " Tk. Stamped in White "1, 2, 3, 4, 5"		1	519 7608472-G6	TS-9	
														TS-10	Not Used						
1	1	1	1	1	1	1	1	1	1	1	1	1	1	TS-11	Terminal Strip	Micarta Strip $4\frac{7}{8}$ " x $\frac{1}{2}$ " of $\frac{1}{16}$ " Tk. Stamped in White "27, 28, 29, 30, 31, 32 and 17"		1	520 7608472-G8	TS-11	
1	1	1	1	1	1	1	1	1	1	1	1	1	1	TS-11	Terminal Strip	Micarta Strip $2\frac{1}{16}$ " x $\frac{1}{2}$ " of $\frac{1}{16}$ " Tk. Stamped in White "37 and 38"		1	521 7608472-G9	TS-11	

Section VII

RESTRICTED

ELECTRICAL PARTS FOR MODEL TDE SERIES RADIO TRANSMITTING EQUIPMENTS (Continued)

Total Per Equipment												Symbol Desig.	Function	Description	Navy Type Number	Navy Spec. Number	Component Mfr.	Component Mfr. Desig.	Contractor's Item No.	Contractor's Drawing Number	All Symbol Designations Involved		
115 V.D.C. —TDE-3	230 V.D.C. —TDE-3	220/440/3/60—TDE-3	115 V.D.C. —TDE-2	230 V.D.C. —TDE-2	220/440/3/60—TDE-2	115 V.D.C. —TDE-1	230 V.D.C. —TDE-1	220/440/3/60—TDE-1	208/3/60 —TDE-1	115/230/1/60—TDE-1	115 V.D.C. —TDE											230 V.D.C. —TDE	220/440/3/60—TDE
1	1	1	1	1	1	1	1	1	1	1	1	1	1		Terminal Strip	Terminal Board Made of Insanol 2 1/2" x 1 1/2" of 3/16" Tk. with Five Terminals Marked 1, 2, 3, 3A and 4			1		522	7410309-G1	
1	1	1	1	1	1	1	1	1	1	1	1	1	1		Insulation—Resistor Mtg.	Micarta XXX254—4 3/4" x 3/4" x 1/8" Tk.			1		523	7608567-P6	
1	1	1	1	1	1	1	1	1	1	1	1	1	1		Insulation—Resistor Mtg.	Micarta XXX254—4 3/4" x 1 1/8" x 1/8" Tk.			1		524	7608567-P7	
1	1	1	1	1	1	1	1	1	1	1	1	1	1		Insulation—Resistor Mtg.	Micarta XXX254—4 3/4" x 2 1/16" x 1/8" Tk.			1		525	7608567-P8	
1	1	1	1	1	1	1	1	1	1	1	1	1	1		Insulation—Resistor Mtg.	Micarta XXX254—4 3/4" x 7/8" x 1/8" Tk.			1		526	7608567-P9	
1	1	1	1	1	1	1	1	1	1	1	1	1	1		Insulation—Resistor Mtg.	Micarta XXX254—4 3/4" x 3/4" x 1/8" Tk.			1		527	7608567-P10	
1	1	1	1	1	1	1	1	1	1	1	1	1	1		Insulation—Resistor Mtg.	Micarta X423—8 3/16" of 3/16" Tk. x 5/16" x 5/16"			1		528	7608530-P3	
1	1	1	1	1	1	1	1	1	1	1	1	1	1		Insulation—Resistor Mtg.	Micarta X423—8 3/16" of 3/16" Tk. x 5/16" x 5/16"			1		529	7608530-P4	
1	1	1	1	1	1	1	1	1	1	1	1	1	1		Insulation—Resistor Mtg.	Micarta X423—12 1/16" of 3/16" Tk. x 5/16" x 5/16"			1		530	7608530-P1	
1	1	1	1	1	1	1	1	1	1	1	1	1	1		Insulation—Resistor Mtg.	Micarta X423—12 1/16" of 3/16" Tk. x 5/16" x 5/16"			1		531	7608530-P2	
1	1	1	1	1	1	1	1	1	1	1	1	1	1		Insulation Frame	Micarta XXX464—5" x 3 5/16" of 3/8" Tk.			1		532	7609539-P8	
7	7	7	7	7	7	7	7	7	7	7	7	7	7		Insulation—Spacer	Isolantite 2 1/2" of 3/8" Dia. Tapped for # 6 Screw Full Length			32		533	7809719-P1	

RESTRICTED

7-47

RESTRICTED

Section VII

ELECTRICAL PARTS FOR MODEL TDE SERIES RADIO TRANSMITTING EQUIPMENTS (Continued)

7-48

RESTRICTED

Total Per Equipment														Symbol Desig.	Function	Description	Navy Type Number	Navy Spec. Number	Component Mfr.	Component Mfr. Desig.	Contractor's Item No.	Contractor's Drawing Number	All Symbol Designations Involved
115 V.D.C. -TDE-3	230 V.D.C. -TDE-3	220/440/3/60-TDE-3	115 V.D.C. -TDE-2	230 V.D.C. -TDE-2	220/440/3/60-TDE-2	115 V.D.C. -TDE-1	230 V.D.C. -TDE-1	220/440/3/60-TDE-1	208/3/60-TDE-1	115/230/1/60-TDE-1	115 V.D.C. -TDE	230 V.D.C. -TDE	220/440/3/60-TDE										
44	44	44	44	44	44	44	44	44	44	44	44	44	44		Insulator	Prestite, No Glaze			1	S# 1176322	534	50-C-682-P4	
6	6	6	6	6	6	6	6	6	6	6	6	6	6		Insulator	Moldarta 3 x 3/4" Tapped #10-32 Each End, 3/8" Thread	-61064-S		1		535	7708565-G3	
6	6	6	6	6	6	6	6	6	6	6	6	6	6		Insulator	Moldarta 1 x 3/4" Tapped #8-32 Each End, 3/8" Thread	-61067-S		1		536	7708565-G4	
2	2	2	2	2	2	2	2	2	2	2	2	2	2		Insulator	Moldarta 2 x 3/4" Tapped #10-32 Each End, 3/8" Thread	-61061-S		1		537	7708565-G1	
2	2	2	2	2	2	2	2	2	2	2	2	2	2		Insulator	Prestite, White Glaze			1	S# 1176328	538	50-C-692-P1	
2	2	2	2	2	2	2	2	2	2	2	2	2	2		Insulator	Prestite, White Glaze			1	S# 1176319	539	50-C-692-P2	
4	4	4	4	4	4	4	4	4	4	4	4	4	4		Insulator	Moldarta 1 1/4" x 3/4" Sq. Tapped 1/4-20 Each End, 3/8" Thread, 1/8" Rounded Corners	-61032-S		1		540	7708566-G2	
8	8	8	8	8	8	8	8	8	8	8	8	8	8		Insulator	Moldarta, 1" x 3/4" Sq. Tapped #10-32 Each End, 3/8" Thread	-61108-S		1		541	7708566-G3	
4	4	4	4	4	4	4	4	4	4	4	4	4	4		Insulator	Moldarta, 1 1/4" x 3/4" Square Tapped #6-32 Each End 3/8" Thread 1/8" Rounded Corners			1		542	7708566-G8	
2	2	2	2	2	2	2	2	2	2	2	2	2	2		Lead in Insulator Assembly	Composed of 1 Post, 2 Plain Washers, 2 Shakeproof Lock-Washers #1810, 2 Lead Washers, 1 Stud, 1 Isolantite Insulator			1		543	7406427-G3	
20	20	20	20	20	20	20	20	20	20	20	20	20	20		Clip-Resistor	For 3/8" Ferrules		RE28AA116A	1		544	7403088-P1	
24	24	24	24	24	24	24	24	24	24	24	24	24	24		Clip-Resistor	Standard Resistor Clip for 40 & 60 Watt Resistor			1	S# 867280	545	7403619-P1	
4	4	4	4	4	4	4	4	4	4	4	4	4	4		Clip-Resistor	Same as 7403619-P1 Except Terminal Lug Removed			1		546	7403619-P2	

Section VII

RESTRICTED

ELECTRICAL PARTS FOR MODEL TDE SERIES RADIO TRANSMITTING EQUIPMENTS (Continued)

Total Per Equipment											Symbol Desig.	Function	Description	Navy Type Number	Navy Spec. Number	Component Mfr.	Component Mfr. Desig.	Contractor's Item No.	Contractor's Drawing Number	All Symbol Designations Involved	
115 V.D.C. —TDE-3	230 V.D.C. —TDE-3	220/440/3/60—TDE-3	115 V.D.C. —TDE-2	230 V.D.C. —TDE-2	220/440/3/60—TDE-2	115 V.D.C. —TDE-1	230 V.D.C. —TDE-1	220/440/3/60—TDE-1	208/3/60 —TDE-1	115/230/1/60—TDE-1											115 V.D.C. —TDE
4	4	4	4	4	4	4	4	4	4	4	4	4	4		Clip—Resistor			1	S# 179521	547	
2	2	2	2	2	2	2	2	2	2	2	2	2	2		Clip—Resistor	Phosphor Bronze		1	S# 867425	548	7407408-P4
2	2	2	2	2	2	2	2	2	2	2	2	2	2		Clip—Resistor	Standard Resistor Clip		1	S# 781379	549	7610465-P1
2	2	2	2	2	2	2	2	2	2	2	2	2	2		Tube Clamp	Nickel Silver # 3296 With Ring 6" x 3/8" of .020 Tk.		1		550	7706940-G7
4	4	4	4	4	4	4	4	4	4	4	4	4	4		Tube Clamp	Nickel Silver # 3296 With Ring 4 7/8" x 3/8" of .020 Tk.		1		551	7611463-G6
6	6	6	6	6	6	6	6	6	6	6	6	6	6		Shockmount	Except Monel		29	# 24-PH-60	552	
2	2	2	2	2	2	2	2	2	2	2	2	2	2		Shockmount	Except Monel		29	# 204-PH-100	553	
12	12	12	12	12	12	12	12	12	12	12	12	12	12		"T" Handle	Material to be Bakelite # 3510 or Moldarta # 199		1		554	7708891-P2
2	2	2	2	2	2	2	2	2	2	2	2	2	2		Gasket	Cork, 4" x 4" of 1/8" Tk.		1		555	7809728P-2
1	1	1	1	1	1	1	1	1	1	1	1	1	1		Coupling			1		556	7606153-G19
3	3	3	3	3	3	3	3	3	3	3	3	3	3		Insulator for Coupling	Isolantite		32		557	7809174-P1
2	2	2	2	2	2	2	2	2	2	2	2	2	2		Coupling	Flexible Coupling		1		558	7606153-G41
1	1	1	1	1	1	1	1	1	1	1	1	1	1		Coupling			1		559	7406449-G2
1	1	1	1	1	1	1	1	1	1	1	1	1	1		Insulator for Coupling	Isolantite		32		560	7809407-P1
1	1	1	1	1	1	1	1	1	1	1	1	1	1		Dial Assembly— Dial "J"			1		561	7608695-G4
1	1	1	1	1	1	1	1	1	1	1	1	1	1		Dial Assembly— Dial "N"			1		562	7608779-G2

RESTRICTED

7-49

RESTRICTED

Section VII

ELECTRICAL PARTS FOR MODEL TDE SERIES RADIO TRANSMITTING EQUIPMENTS (Continued)

7-50

RESTRICTED

Total Per Equipment													Symbol Desig.	Function	Description	Navy Type Number	Navy Spec. Number	Component Mfr.	Component Mfr. Desig.	Contractor's Item No.	Contractor's Drawing Number	All Symbol Designations Involved
115 V.D.C. —TDE-3	230 V.D.C. —TDE-3	220/440/3/60—TDE-3	115 V.D.C. —TDE-2	230 V.D.C. —TDE-2	220/440/360—TDE-2	115 V.D.C. —TDE-1	230 V.D.C. —TDE-1	220/440/3/60—TDE-1	208/3/60—TDE-1	115/230/1/60—TDE-1	115 V.D.C. —TDE	230 V.D.C. —TDE										
8	8	8	8	8	8	8	8	8	8	8	8	8	8		Dial Assembly—Dials "E, G, K, M, O, R, S, W"		1		563	7608695-G2		
2	2	2	2	2	2	2	2	2	2	2	2	2	2		Dial Assembly—Dials "C" and "P"		1		564	7608787-G1		
1	1	1	1	1	1	1	1	1	1	1	1	1	1		Calibration Chart Assembly		1		565	7608775-G1		
1	1	1	1	1	1	1	1	1	1	1	1	1	1		Support Leg		1		566	7608557-G1		
2	2	2	2	2	2	2	2	2	2	2	2	2	2		Clip	Tube Cap Clip	26	Type 12	567	7708842-P11		
3	3	3	3	3	3	3	3	3	3	3	3	3	3		Clip	Tube Cap Clip	26	Type 24	568	7708842-P12		
1	1	1	1	1	1	1	1	1	1	1	1	1	1		Paper	Calibration Sheet	30		569	7708635-P1		
0	0	0	0	0	0	0	0	0	0	0	0	0	0		Nameplate	"Increase" With Clockwise Arrow	1		570	NP-40137		
0	0	0	0	0	0	0	0	0	0	0	0	0	0		Lockwasher	External Tooth	1	# 1804	571	DL-7502438 L19		
0	0	0	0	0	0	0	0	0	0	0	0	0	0		Screw	Binding Head # 4-40 x $\frac{3}{16}$ Long, Steel, Cadmium Plated	1		572	DL-7502438 L20		
0	0	0	0	0	0	0	0	0	0	0	0	0	0		Cover Assembly		1		573	7409775-G1		
0	0	0	0	0	0	0	0	0	0	0	0	0	0		Flexible Lead	# 16 Stranded Glass Covered Wire With Red Tracer	1		574	7708842-P5		
2	2	2	2	2	2	2	2	2	2	2	2	2	2		Insulators for Mounting C-311		6		575	7602239-P43		
6	6	6	6	6	6	6	6	6	6	6	6	6	6		Insulation for Mounting C-312	Same as Item 536	1		576			

Section VII

RESTRICTED

APPLICABLE COLOR CODES AND MISCELLANEOUS DATA FOR MODEL TDE SERIES RADIO TRANSMITTING EQUIPMENTS

COLOR CODE IN MMFD. FOR CAPACITORS

Color	A 1st Digit	B 2nd Digit	C Ciphers
Black	—	0	.0
Brown	1	1	0
Red	2	2	00
Orange	3	3	000
Yellow	4	4	0000
Green	5	5	00000
Blue	6	6	000000
Purple	7	7	0000000
Gray	8	8	00000000
White	9	9	—

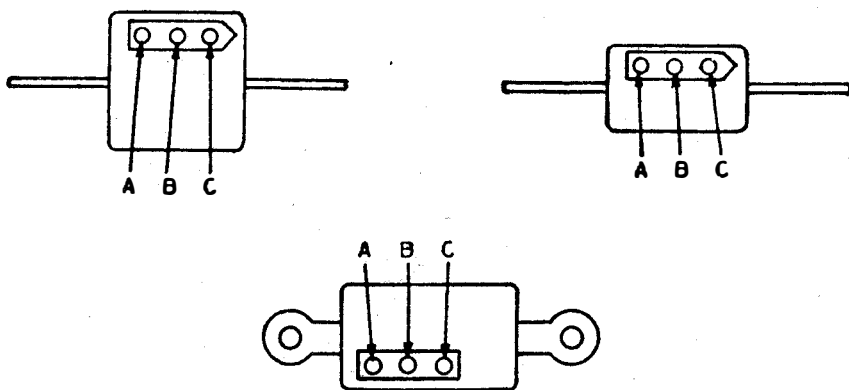

RCA COLOR CODED CAPACITORS

CAPACITY IN MMFD.

VALUES DESIGNATE TOLERANCE BY COLOR.

Yellow $\pm 20\%$

Blue $\pm 10\%$

Black $\pm 5\%$

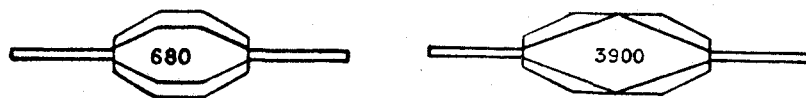

RMA COLOR CODE FOR RESISTORS

Color	A 1st Digit	B 2nd Digit	C Ciphers
Black	—	0	.0
Brown	1	1	0
Red	2	2	00
Orange	3	3	000
Yellow	4	4	0000
Green	5	5	00000
Blue	6	6	000000
Purple	7	7	0000000
Gray	8	8	00000000
White	9	9	—

D—TOLERANCE CODE:

Gold = 5%

Silver = 10%

Omit = 20%

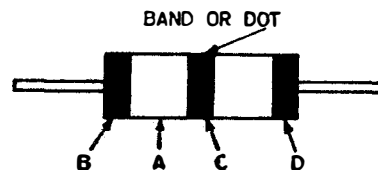

ORIGINAL COLOR ARRANGEMENT FOR AXIAL LEADS



NEW COLOR ARRANGEMENT FOR AXIAL LEADS

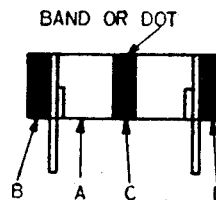

STANDARD COLOR ARRANGEMENT FOR RADIAL LEADS

LIST OF MANUFACTURERS—TDE SERIES LIST

Code Number	Mfr. Prefix	Name	Address	Code Number	Mfr. Prefix	Name	Address
1	CAY	Westinghouse Elec. & Mfg. Co.	2519 Wilkens Avenue, Baltimore, Maryland	16	{ CAO CIR	Ward Leonard Elec. Co. International Resistance Co.	Mr. Vernon, N. Y. Philadelphia, Pa.
2	{ CD CAW	Cornell Dubilier Cond. Corp. Aerovox Corp.	South Plainfield, N. J. New Bedford, Mass.	17	CSF	Sprague Specialties Co.	North Adams, Mass.
3	{ CD CAW CSL	Cornell Dubilier Cond. Corp. Aerovox Corp. Solar Mfg. Co.	South Plainfield, N. J. New Bedford, Mass. Bayonne, N. J.	18	COM	Ohmite Mfg. Co.	4835 W. Flourney Street, Chicago, Ill.
4	CHC	Hammarlund Mfg. Co.	424 W. 33rd Street New York, N. Y.	19	CIR	International Resistance Co.	Philadelphia, Pa.
5	CBK	Allen D. Cardwell Mfg. Co.	81 Prospect Street, Brooklyn, N. Y.	20	CWL	Westinghouse Lamp Co.	Bloomfield, N. J.
6	CCO	The Carborundum Co. Globar Div.	Niagara Falls, N. Y.	21	CAO	Ward Leonard Elec. Co.	Mr. Vernon, N. Y.
7	CFA	Bussman Mfg. Co.	2538 W. University Avenue, St. Louis, Missouri	22	CAE	Cutler Hammer Inc.	1369 W. St. Paul Avenue, Milwaukee, Wisc.
8		Chase Shawmut Co.	Merrimac Street, Newburyport, Mass.	23		Arco Electric Co.	3167 Fulton Road, Cleveland, Ohio
9	CYD	Bryant Electric Co.	Bridgeport, Conn.	24	CHH	Hart & Hegeman	Hartford, Conn.
10	CLF	Littefuse Lab.	4757 Ravenswood Avenue, Chicago, Ill.	25	CRC	R.C.A. Radiatron Corp.	Harrison, N. J.
11		Drake Mfg. Co.	Chicago, Ill.	26	CNA	National Co., Inc.	61 Sherman Street, Malden, Mass.
12	CTE	Telephonics	350 W. 31st Street, New York, N. Y.	27	CHC	Hammarlund Mfg. Co.	424 W. 33rd Street, New York, N. Y.
13	CRY	C. P. Clare & Co.	Chicago, Ill.	28	CEJ	E. F. Johnson Co.	Waseca, Minn.
14	{ CAY CTR	Westinghouse Elec. & Mfg. Co. Chicago Transformer	2519 Wilkens Avenue, Baltimore, Maryland 3501 Addison Street, Chicago, Ill.	29	CJC	H. B. Jones	2300 Wabansia Avenue, Chicago, Ill.
15		New Departure Div. of General Motors	Bristol, Conn.	30		Lord Mfg. Co. D. M. Owens	Erie, Pa. 308 S. Hanover Street, Baltimore, Maryland
				31	{ CD CMA	Cornell Dubilier Cond. Corp. P. R. Mallory	So. Plainfield, N. J. 1941 Thomas Street, Indianapolis, Ind.
				32	CSU	Isolantite Inc.	343 Courtland Street, Belleville, N. J.

RESTRICTED

Section VII

RESTRICTED

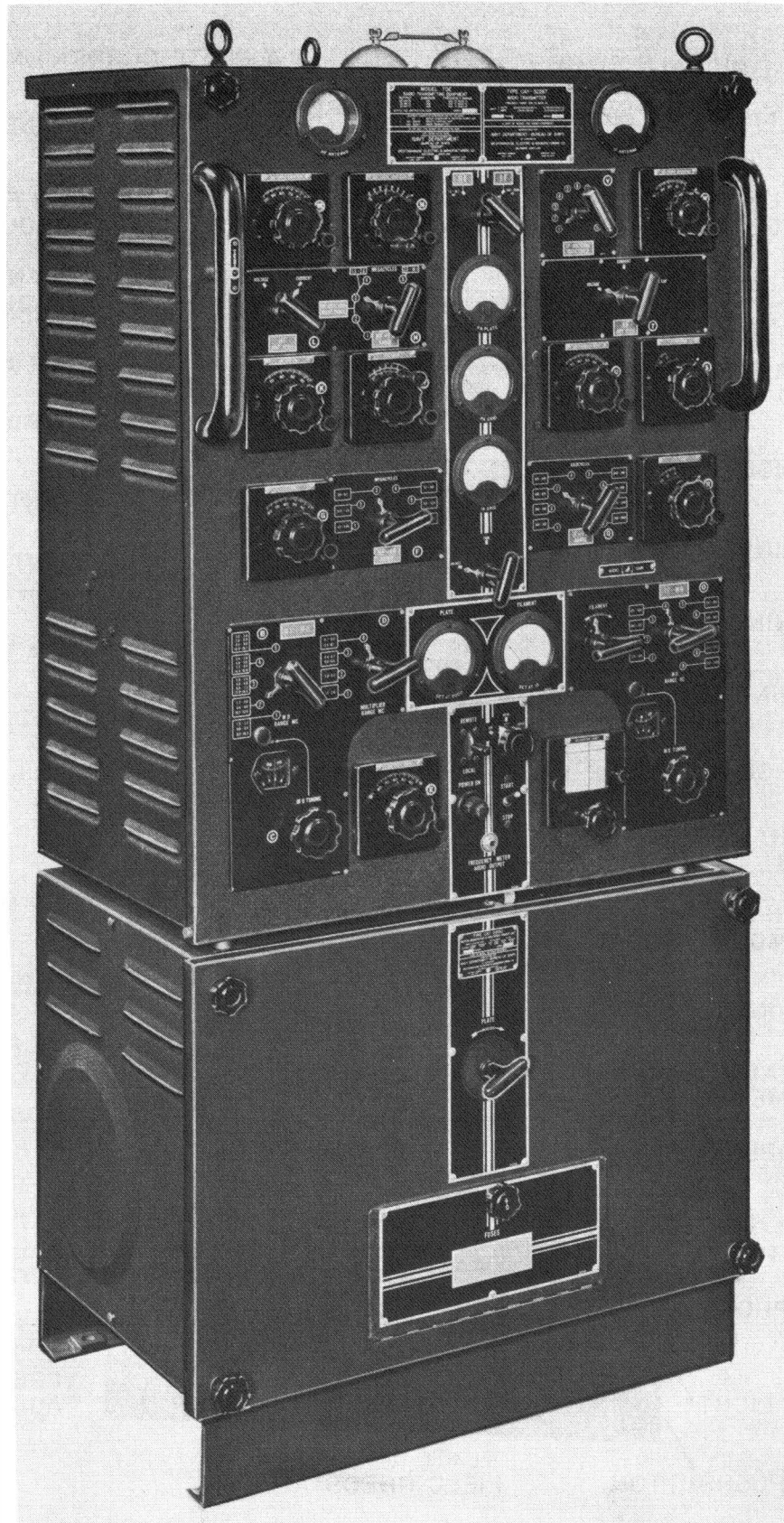

Figure 8-1—Transmitter Unit, Navy Type CAY-52267 and Power Unit, Navy Types CAY-21848, CAY-21849, or CAY-21850. Front Left Oblique View, Access Doors Closed. (Photo C-5921)

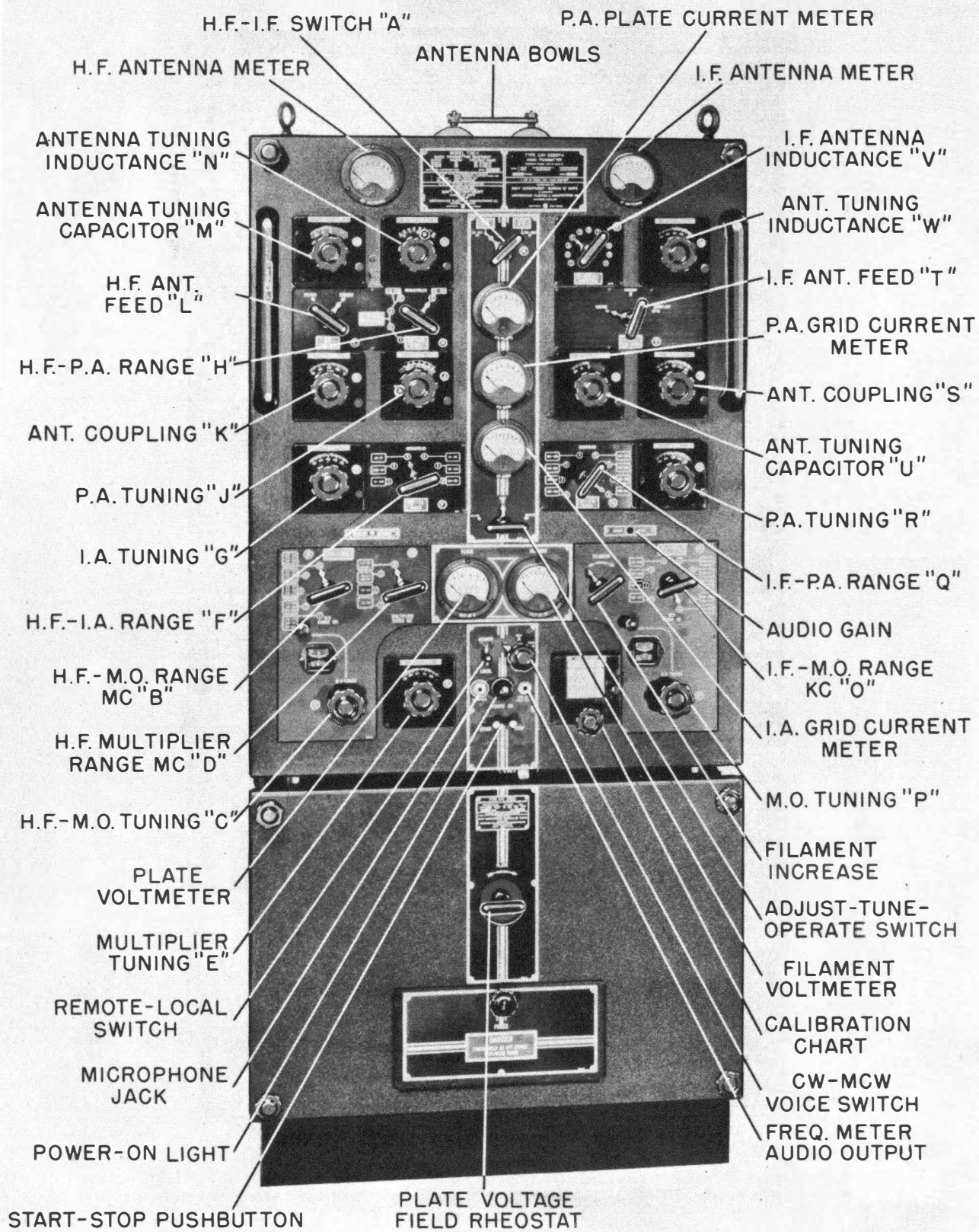

Figure 8-2—Transmitter Unit, Navy Type CAY-52267A and Power Unit, Navy Types CAY-21848, CAY-21849, CAY-21850, or CAY-211030. Front View, Access Doors Closed.
(Photo C-7301)

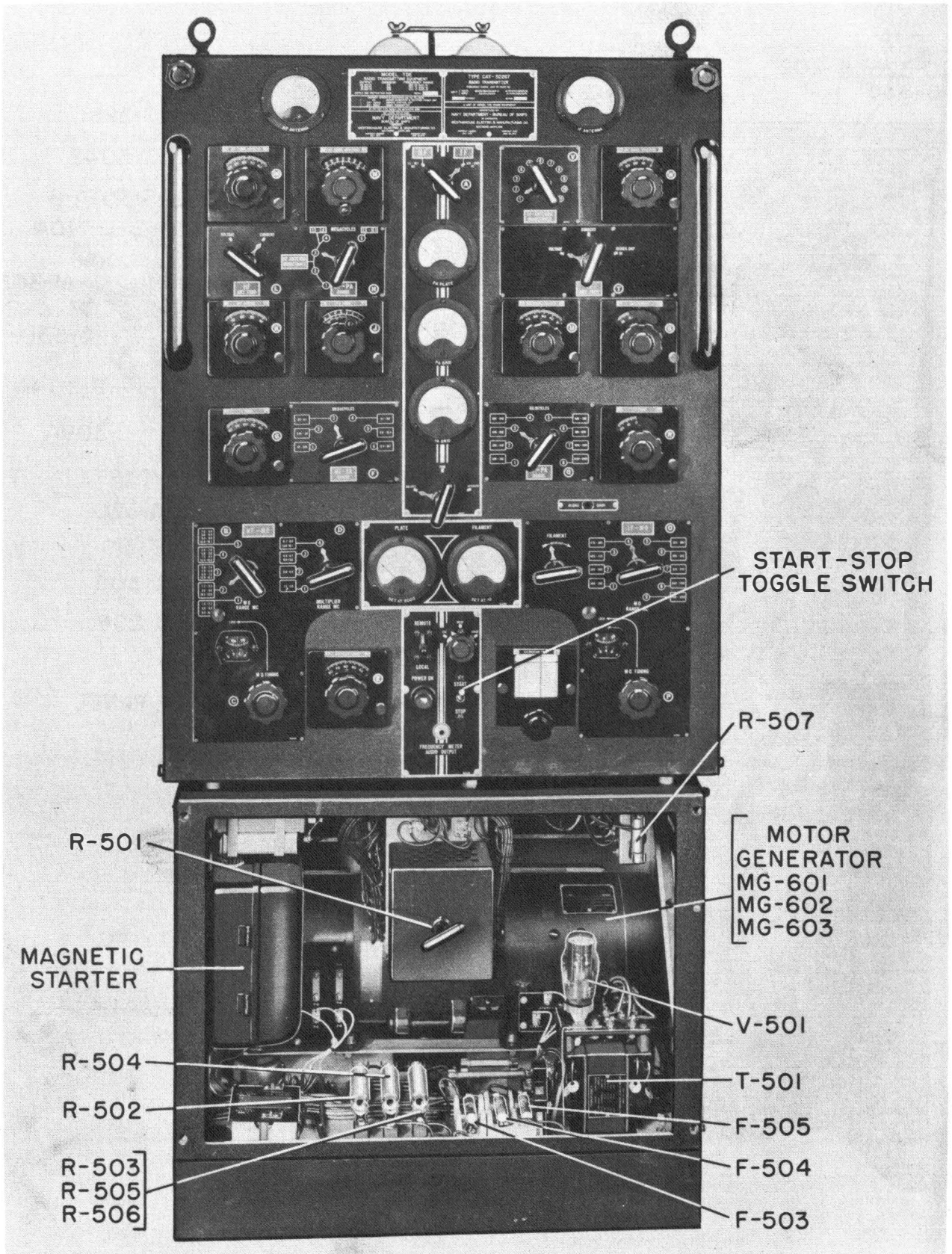

Figure 8-3—Transmitter Unit, Navy Type CAY-52267 and Power Unit, Navy Types CAY-21848, CAY-21849, or CAY-21850. Front View, Access Doors Open. (Photo C-5920)

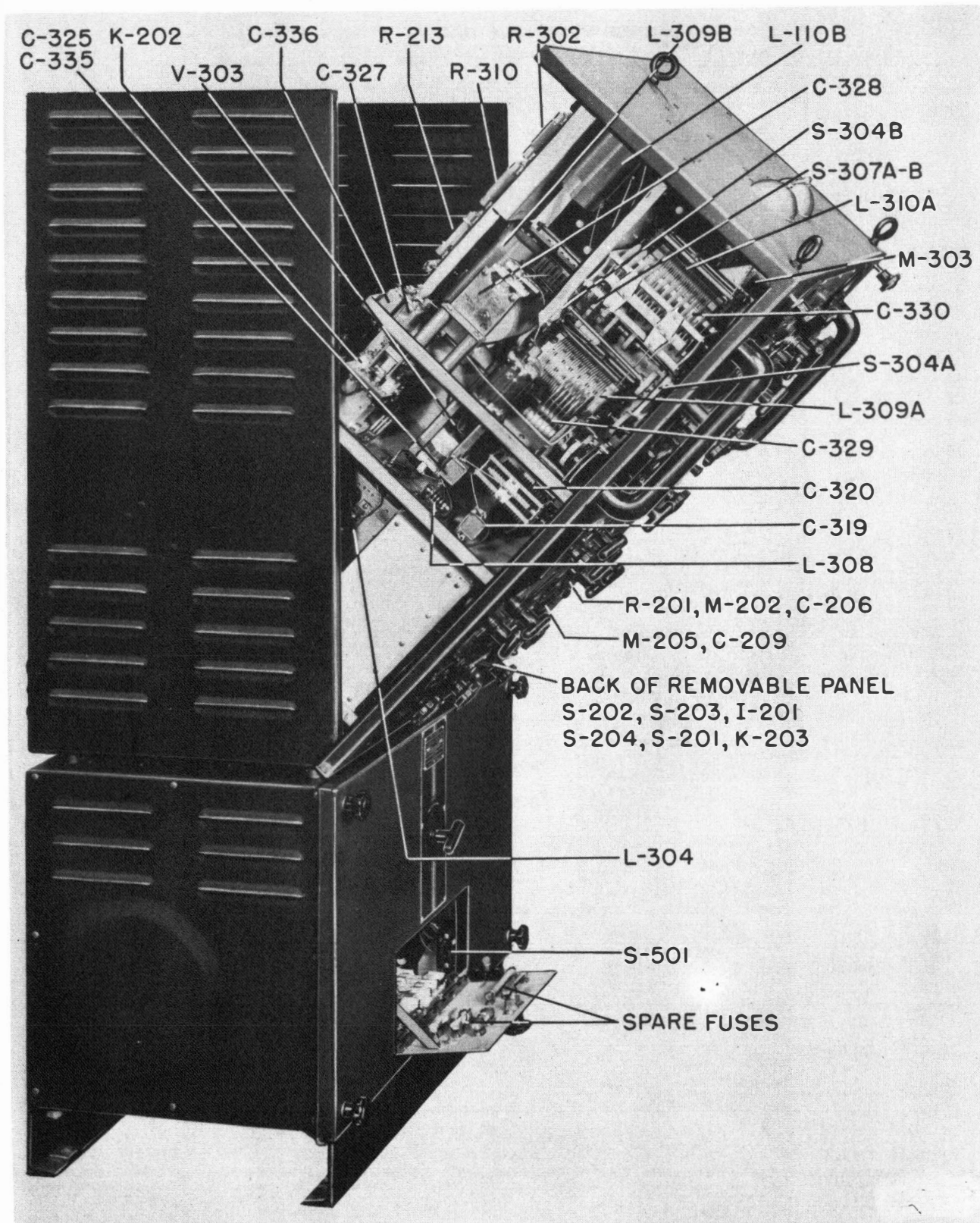

Figure 8-4—Transmitter Unit, Navy Type CAY-52267 and Power Unit, Navy Types CAY-21848, CAY-21849, or CAY-21850. Front Left Oblique View, Access Panel Removed, Transmitter out 45°. (Photo C-5916)

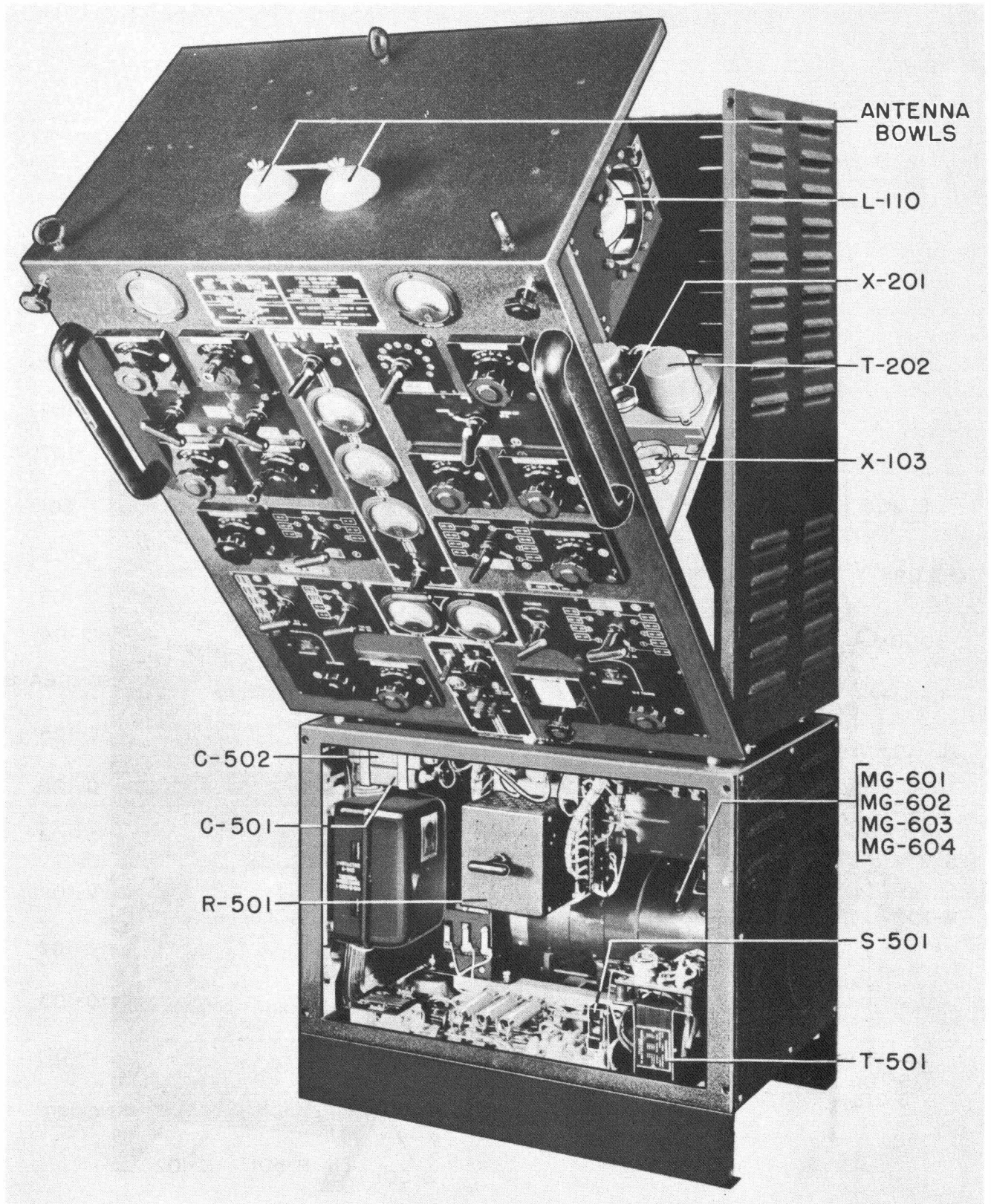

Figure 8-5—Transmitter Unit, Navy Type CAY-52267A and Power Unit, Navy Types CAY-21848, CAY-21849, CAY-21850, or CAY-211030. Front Right Oblique View, Access Panel Removed, Transmitter out 45°. (Photo C-7302)

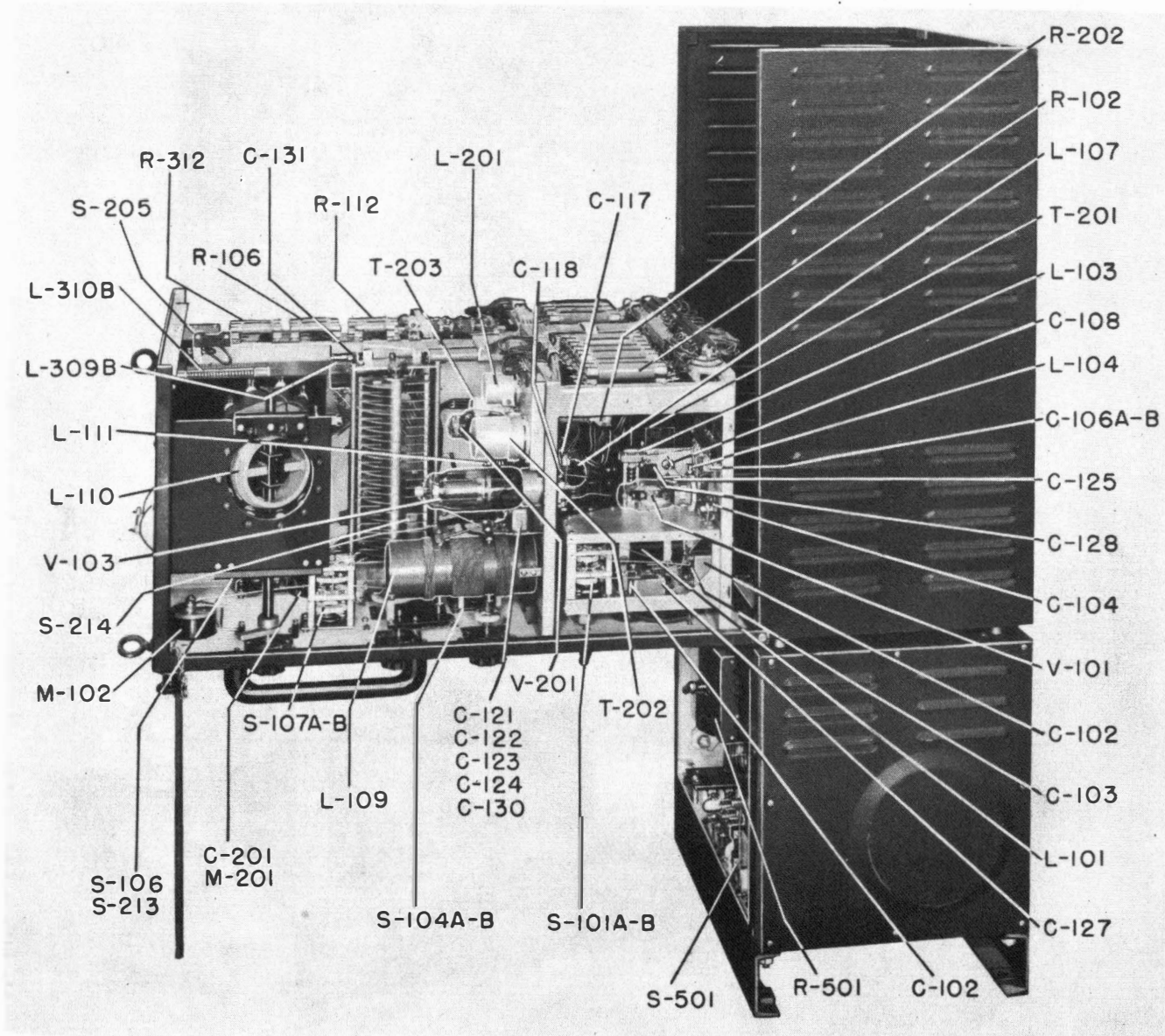

Figure 8-6—Transmitter Unit, Navy Type CAY-52267 and Power Unit, Navy Types CAY-21848, CAY-21849, or CAY-21850. Front Right Oblique View, Access Panel Removed, Transmitter out 90°. (Photo C-5914)

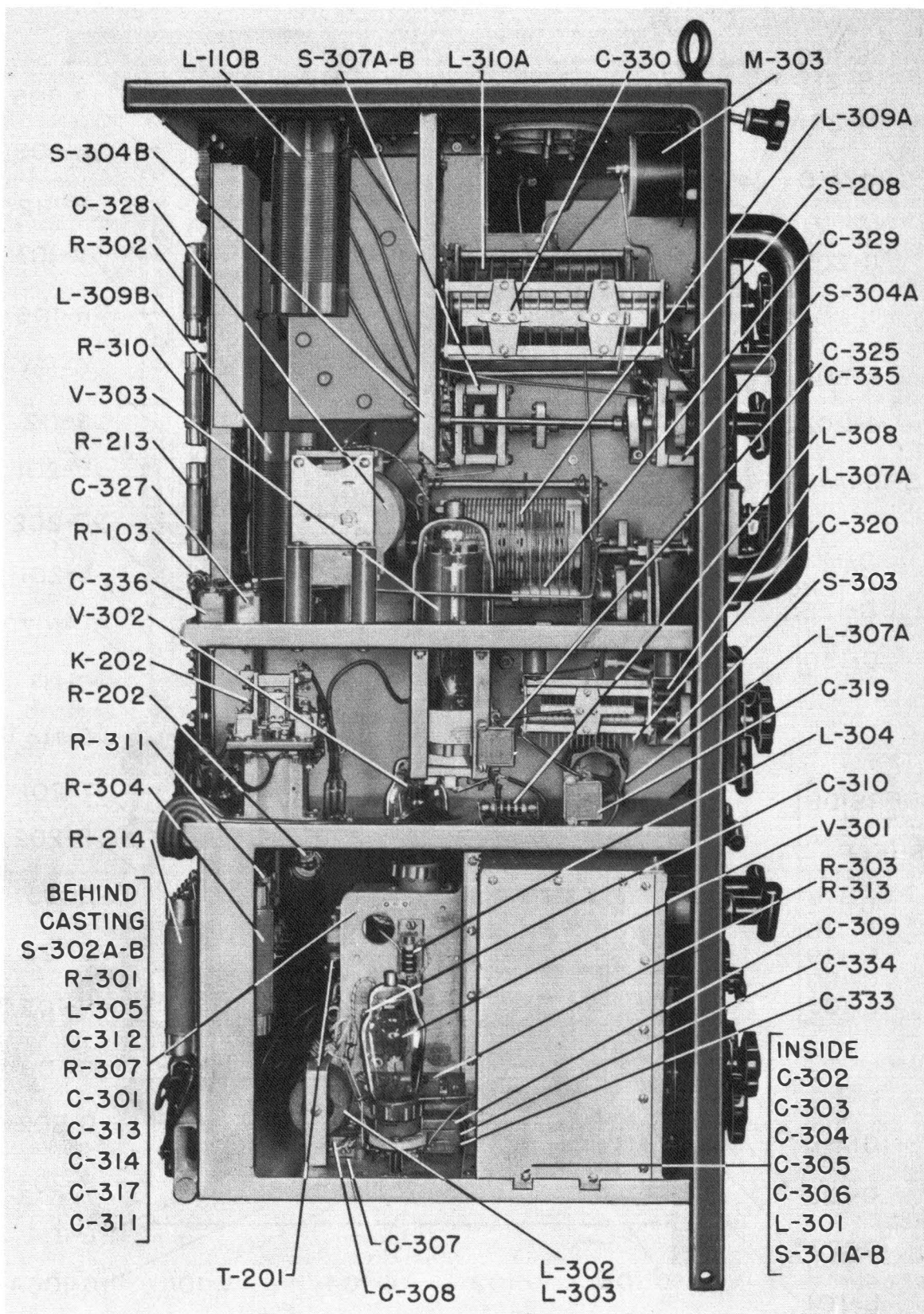

Figure 8-7—Transmitter Unit, Navy Types CAY-52267 or CAY-52267A, Removed From Case, Left Side View. (Photo C-5917)

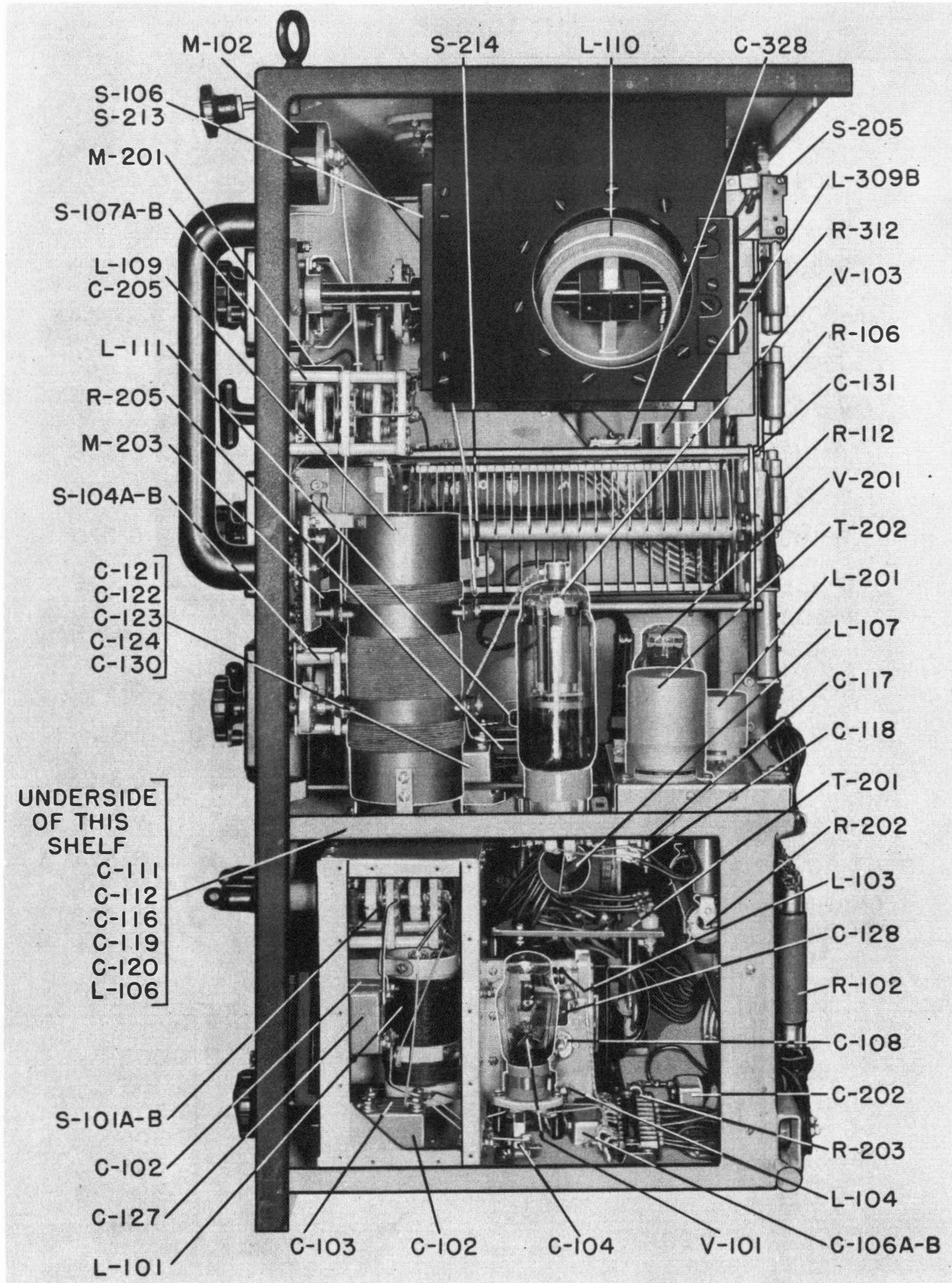

Figure 8-8—Transmitter Unit, Navy Types CAY-52267 or CAY-52267A, Removed From Case, Right Side View. (Photo C-5915)

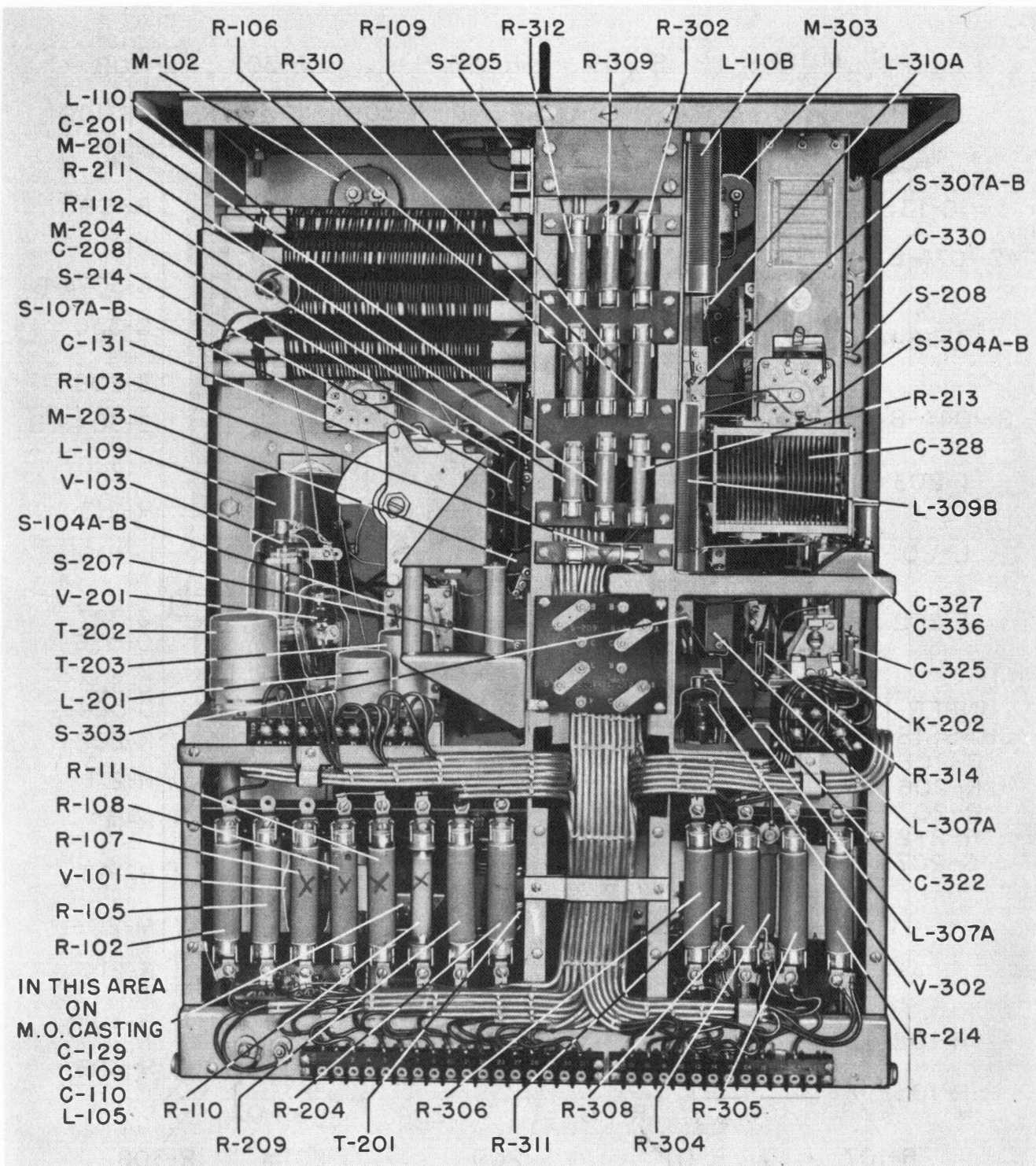

Figure 8-9—Transmitter Unit, Navy Type CAY-52267, Removed From Case, Rear View. (Photo C-5919)

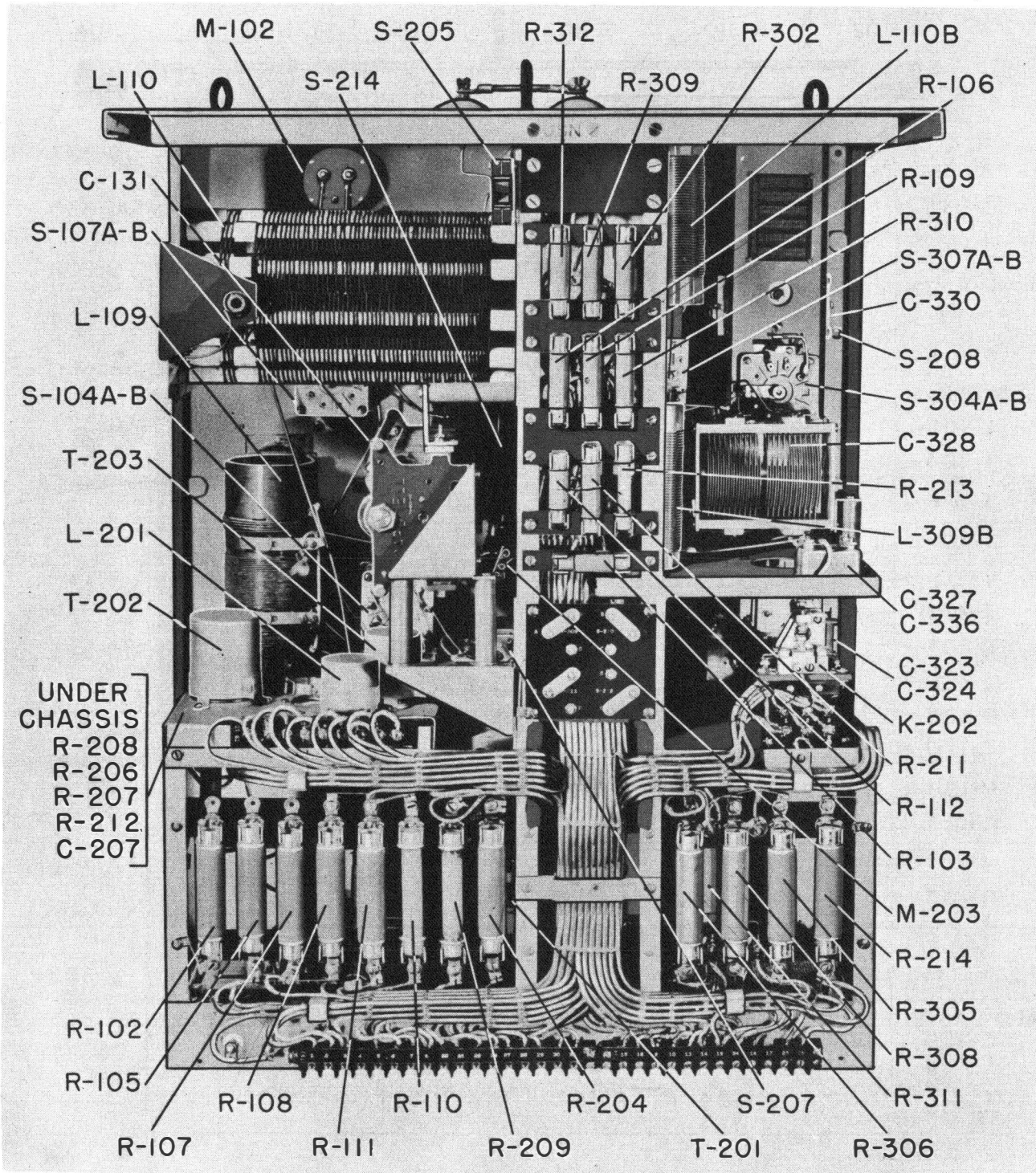

Figure 8-10—Transmitter Unit, Navy Type CAY-52267A, Removed From Case, Rear View. (Photo C-7298)

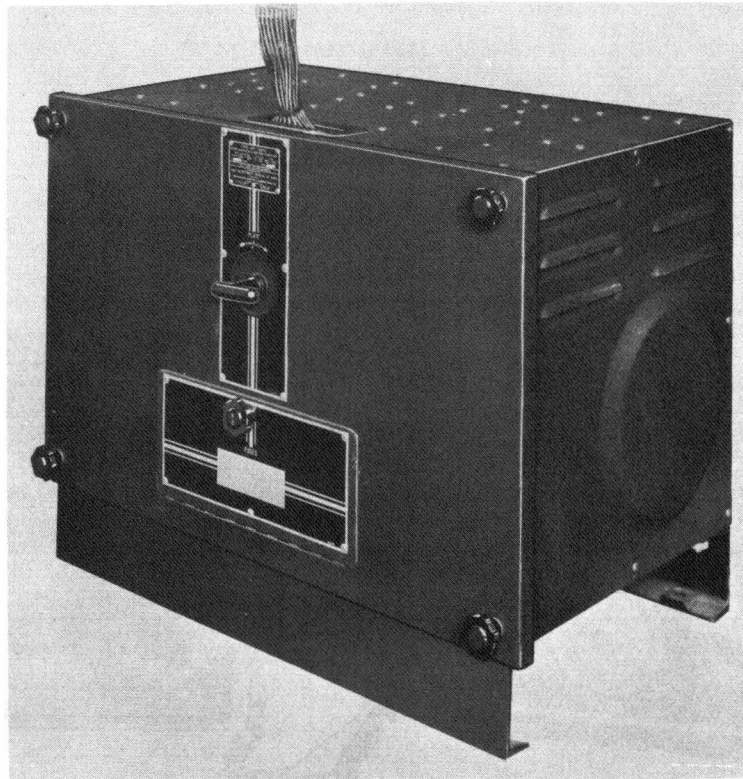

Figure 8-11—Power Unit, Navy Types CAY-21848, CAY-21849, CAY-21850, or CAY-211030, Removed From Case, Front Right Oblique View, Access Door in Place. (Photo C-5924)

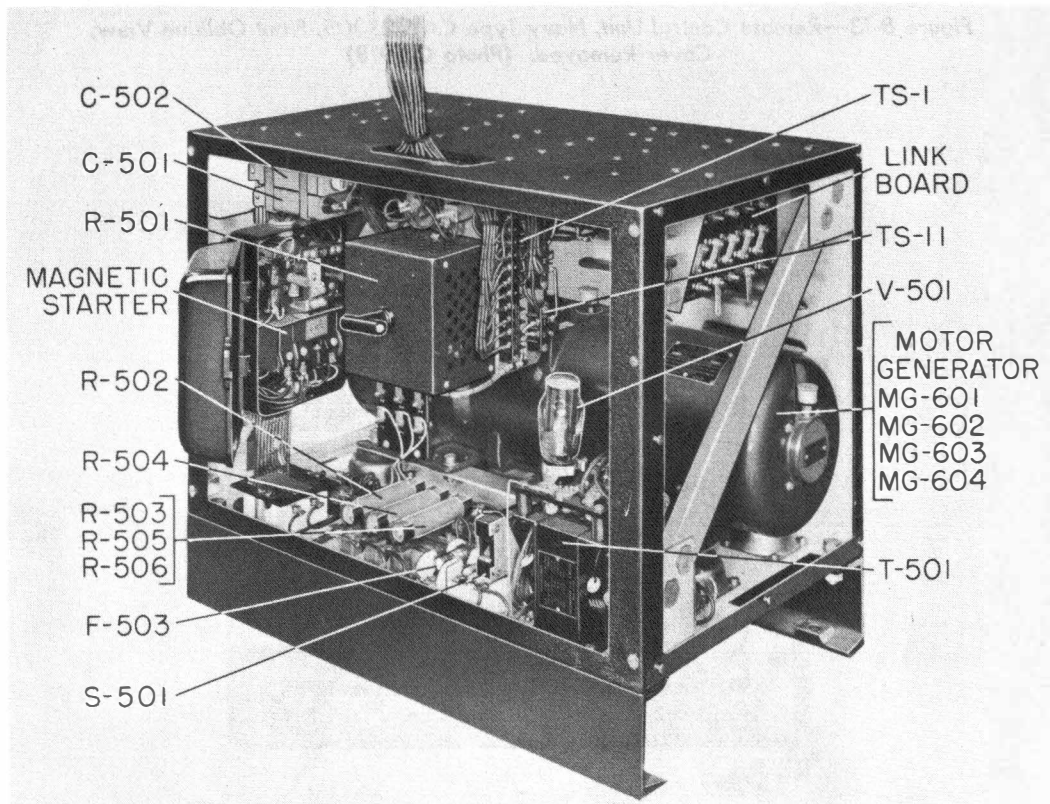

Figure 8-12—Power Unit, Navy Types CAY-21848, CAY-21849, CAY-21850 or CAY-211030, Removed From Case, Front Right Oblique View, Access Door and Shields Removed. (Photo C-5923)

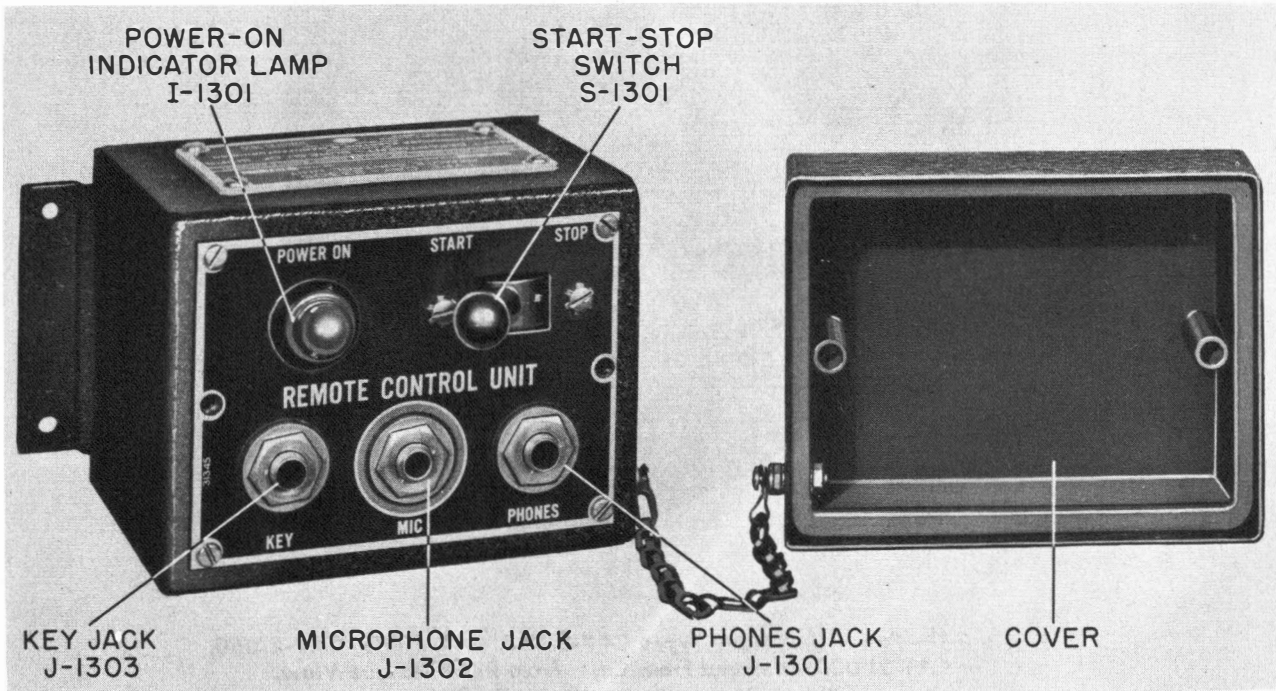

Figure 8-13—Remote Control Unit, Navy Type CAY-23305, Front Oblique View, Cover Removed. (Photo C-5918)

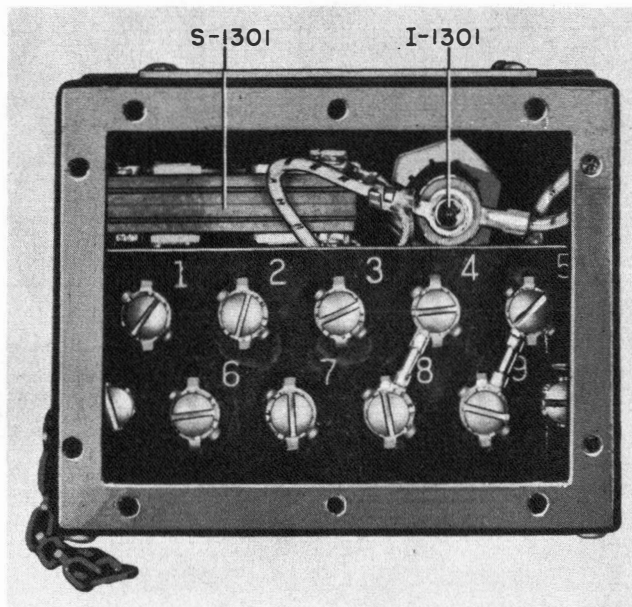

Figure 8-14—Remote Control Unit, Navy Type CAY-23305, Rear View, Cover Removed. (Photo C-5922)

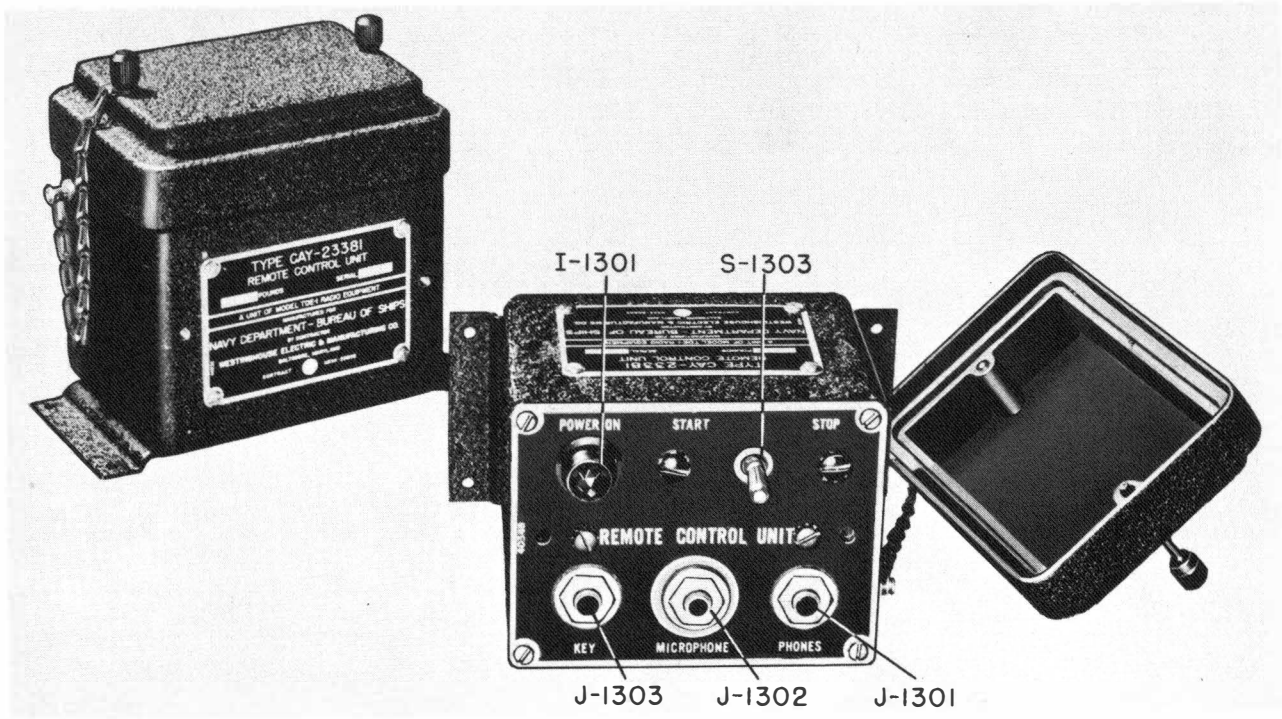
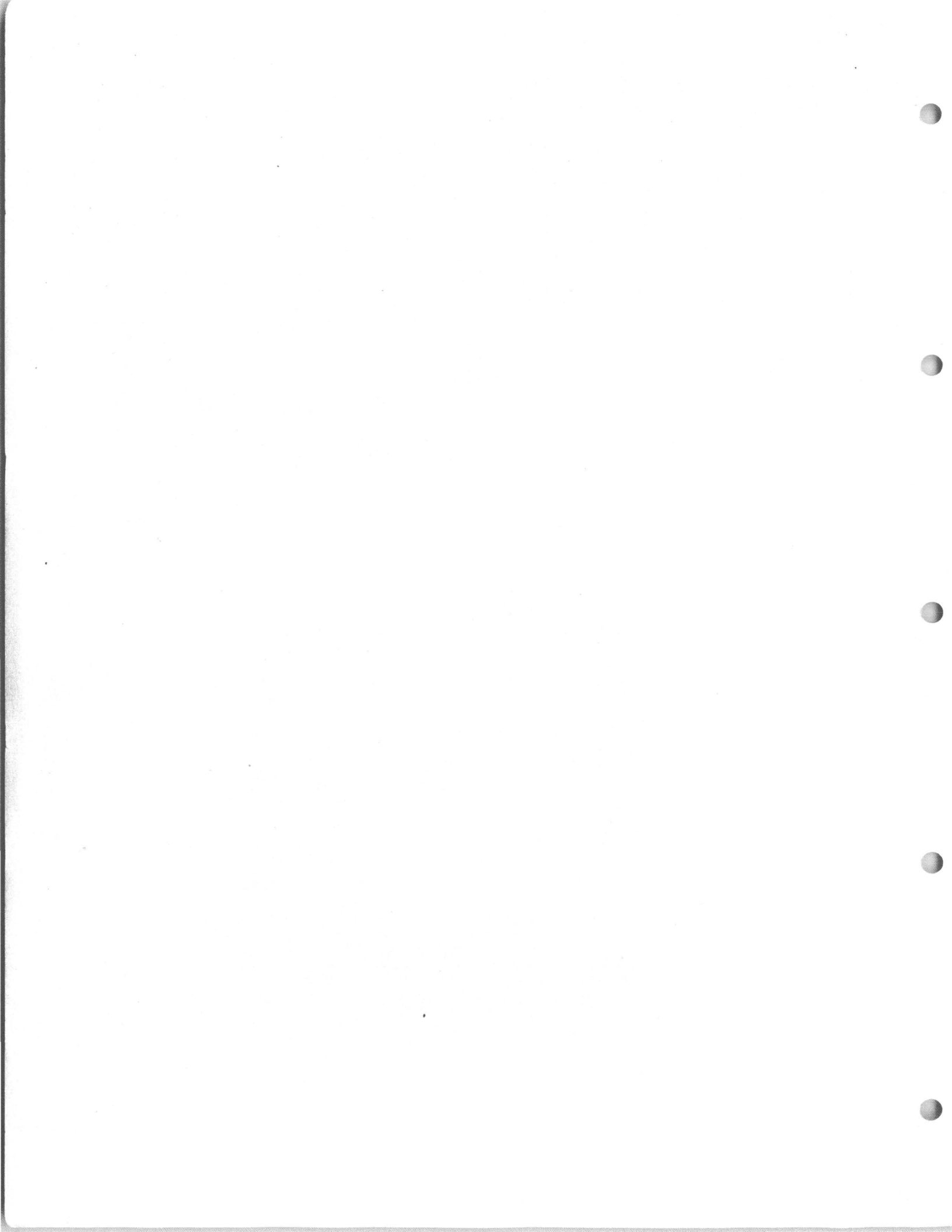

Figure 8-15—Remote Control Unit, Navy Type CAY-23381. Composite Front View. (Photo C-7300)



Figure 8-16—Autotransformer, Navy Type CAY-301145, Front Oblique View. (Photo C-7299)



Note - The following Navy Model TDE-2 Equipments are in accordance with this drawing. Other Navy Model TDE-2 Equipments are in accordance with figure 8-25

Navy Model TDE-2 Equipments
Serials #1 to #71 inclusive
Serials #372 to #503 inclusive
Serials #900 to #1045 inclusive
Serials #1066 to #1104 inclusive
Serials #1422 to #2228 inclusive
Serials #2229 to #2402 inclusive

Figure 8-26—Transmitter Unit, Power Unit, and Remote Control Unit, Schematic Diagram for Navy Model TDE-2. (Dwg. 7300577)

LINK POSITIONS FOR REMOTE CONTROL

LINK	TYPE OF REMOTE CONTROL			
	NAVY 4 WIRE	WESTINGHOUSE 4 WIRE	NAVY TYPE 23005 6 WIRE	NAVY TYPE 23146 6 WIRE
S209	A TO B	A TO B	A TO B	A TO B
S210	A TO C	A TO C	A TO C	A TO C
S211	D TO E	D TO E	D TO E	D TO E
S212	A TO C	A TO C	A TO C	A TO C
S213	OPEN	OPEN	CLOSED	CLOSED
S214	OPEN	OPEN	CLOSED	CLOSED

RECTIFIER MOTOR GENERATOR AND POWER SUPPLY LINK POSITIONS

LINK	DC	3 PHASE AC SINGLE PHASE AC			
		115 V	230 V	440 V	115 V
S502	A TO C	A TO C	A TO C	A TO C	A TO B
S503	A TO C	A TO C	A TO C	A TO C	A TO B
S504	A TO B	A TO B	A TO B	A TO B	A TO C
S505	A TO B	A TO B	A TO B	A TO B	A TO C
S506	A TO C	A TO C	A TO C	A TO C	A TO B
S507	A TO C	A TO C	A TO C	A TO C	A TO B
S508	A TO C	A TO C	A TO C	A TO C	A TO B
S509	A TO C	A TO C	A TO C	A TO C	A TO B
S510	A TO C	A TO C	A TO C	A TO C	A TO B
S511	A TO C	A TO C	A TO C	A TO C	A TO B

NOTE: FOR 230 V DC USE LINK FROM S510C TO S511C AS SHOWN FOR 230 V DC USE LINK FROM S508C TO S509C AS SHOWN FOR OTHER VOLTAGES LEAVE THESE LINKS OPEN

TRANSFORMER LINK POSITIONS

TRANSFORMER TYPE NO.	NAVY FORMER TYPE NO.	POWER SOURCE			
		D.C.	3 PHASE AC	SINGLE PHASE AC	115 V
T201	30928	1 TO 3	1 TO 4	1 TO 4	1 TO 4
T202	30926	2 TO 6	2 TO 6	2 TO 6	2 TO 6
T203	30927	1 TO 3	1 TO 3	1 TO 3	1 TO 3

* NOTE: LEADS NORMALLY CONNECTED TO TERMINALS #1 AND #4 SHOULD BE CONNECTED TO TERMINALS #3 AND #6 AND ALL LINKS PLACED ACROSS #1 TO #3 OR #2 TO #4

† NOTE: CONNECT LINKS 1 TO 3 AND 2 TO 4. PLACE BOTH SECONDARY LINKS 6 TO 7

FOR 230 V DC OPERATION
CIRCUIT IS SAME AS FOR 115 V DC OPERATION EXCEPT AS FOLLOWS:
MOTOR OF M6-601 REPLACED BY MOTOR OF M6-602
K501 IS REPLACED BY K502 (HEATER ONLY)
USE SYMBOLS ENCLOSED THUSLY FOR WIG CAPACITORS.

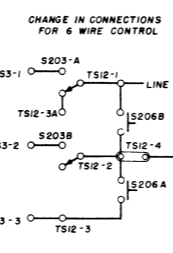
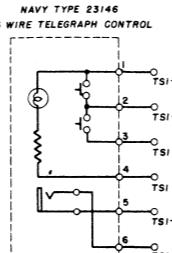
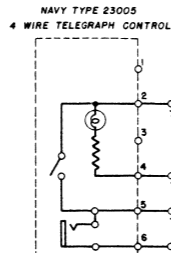
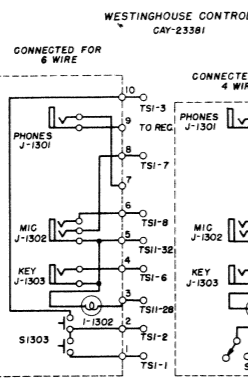

NOTE: TERMINAL BOARD TS12 IS LOCATED BEHIND START-STOP SWITCH PANEL (SEE DRAWING 7300578 IN INSTRUCTION BOOK)

ADD JUMPER BETWEEN TSI-32 & TSI-5

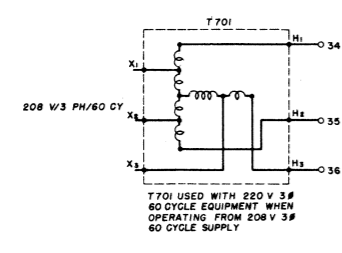

T701 USED WITH 230 V 3# 60 CYCLE SUPPLY

NOTE: THE FOLLOWING TOE-8 EQUIPMENTS ARE IN ACCORDANCE WITH THIS DRAWING. OTHER TOE-2 EQUIPMENTS LISTED ON 7300540 DIFFER IN THE LOCATION OF S207-B.

115 V EQUIPMENT SERIALS #1 - #71 INCL.
230V EQUIPMENT SERIALS #72 - #303 INCL.
230V EQUIPMENT SERIALS #106 - #104 INCL.
440V EQUIPMENT SERIALS #200 - #1045 INCL.
440V EQUIPMENT SERIALS #229 - #2402 INCL.

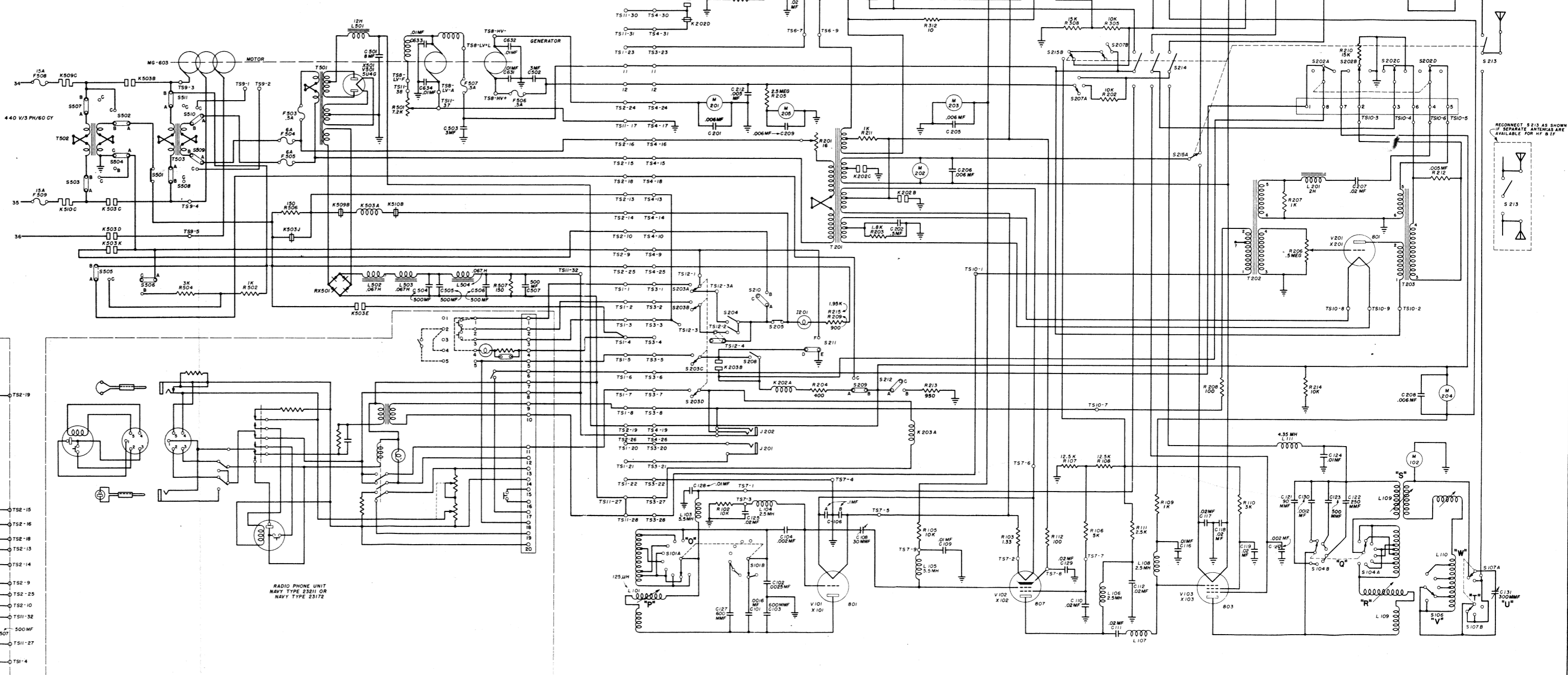

Figure 8-26—Transmitter Unit, Power Unit, and Remote Control Unit, Schematic Diagram for Navy Model TDE-2. (Dwg. 7300577)

Note - All Navy Model TDE-1 Equipments and the following Navy Model TDE-2 Equipments are in accordance with drawing. Other Navy Model TDE-2 Equipments are in accordance with figure 8-29

Navy Model TDE-2 Equipments

Serials #72 to #371 inclusive

Serials #504 to #516 inclusive

Serials #517 to #899 inclusive

Serials #1046 to #1065 inclusive

Serials #1105 to #1422 inclusive

Figure 8-28—Transmitter Unit, Wiring Diagram for Navy Models TDE-1 and TDE-2. (Dwg. 7300541)

Note - The following Navy Model TDE-2 Equipments are in accordance with this drawing. Other Navy Model TDE-2 Equipments are in accordance with figure 8-28

Navy Model TDE-2 Equipments
Serials #1 to #71 inclusive
Serials #372 to #503 inclusive
Serials #900 to #1045 inclusive
Serials #1066 to #1104 inclusive
Serials #1422 to #2228 inclusive
Serials #2229 to #2402 inclusive

Figure 8-29—Transmitter Unit, Wiring Diagram for Navy Model TDE-2. (Dwg. 7300578)

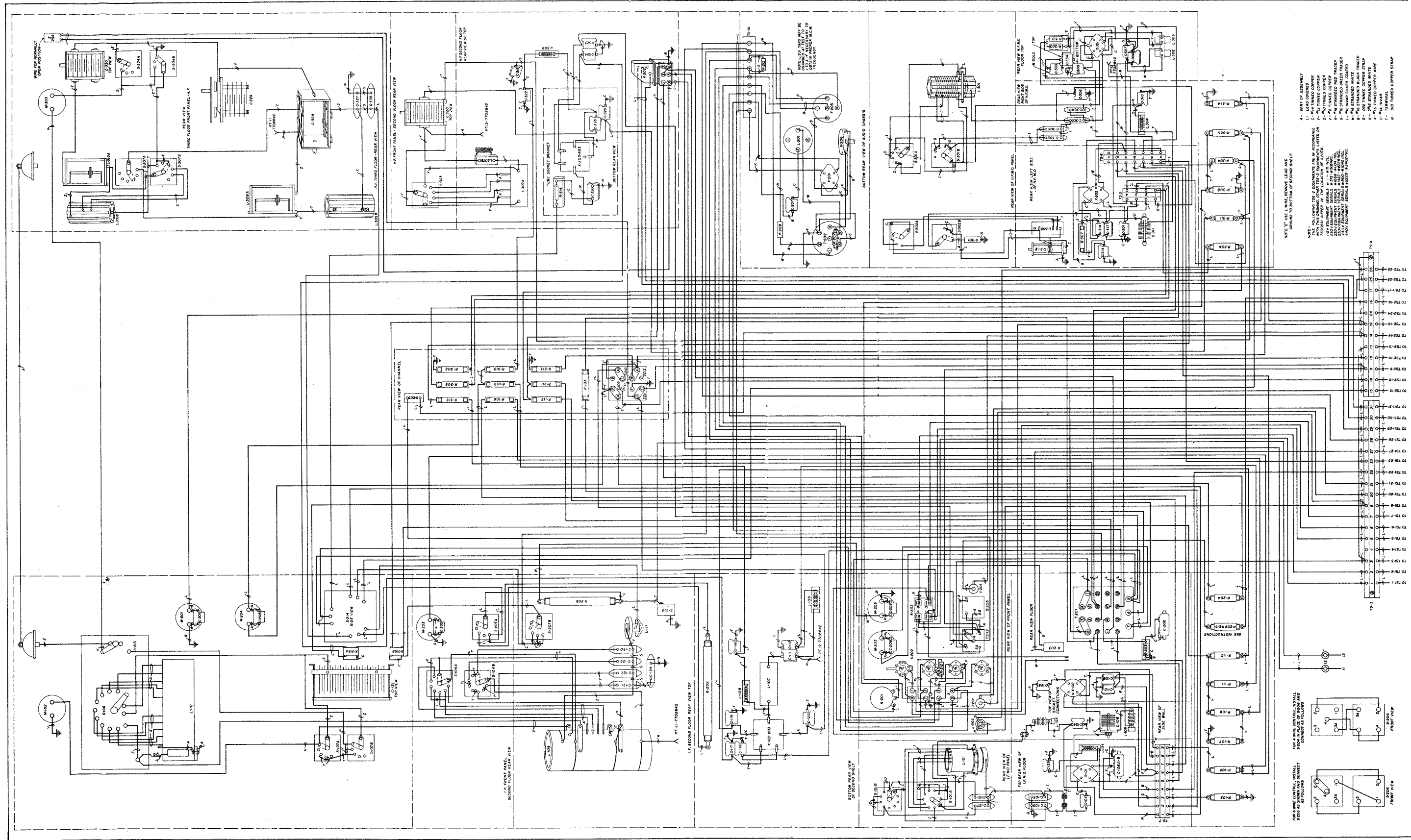
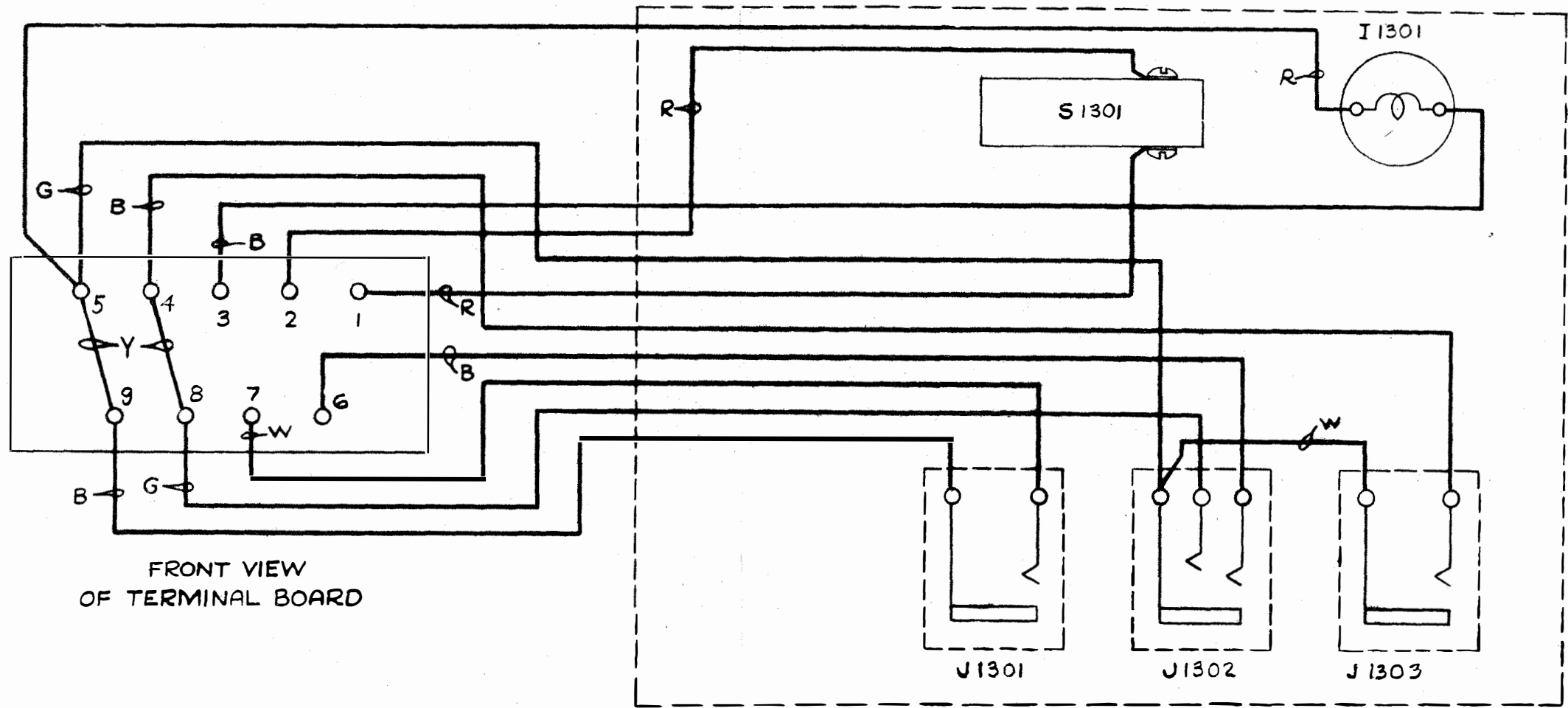

Figure 8-29—Transmitter Unit, Wiring Diagram for Navy Model TDE-2. (Dwg. 7300578)



FRONT VIEW OF TERMINAL BOARD

J 1301 J 1302 J 1303

REAR VIEW

WIRE LEGEND

- B-#16 STRANDED BLACK TRACER
- G-#16 STRANDED GREEN TRACER
- R-#16 STRANDED RED TRACER
- W-#16 STRANDED WHITE TRACER
- Y-#12 TINNED COPPER(USED ON TCE 1/2 ONLY)

Figure 8-31—Remote Control Unit, Type CAY-23305, Wiring Diagram for Navy Model TDE. (Dwg. 7708883)

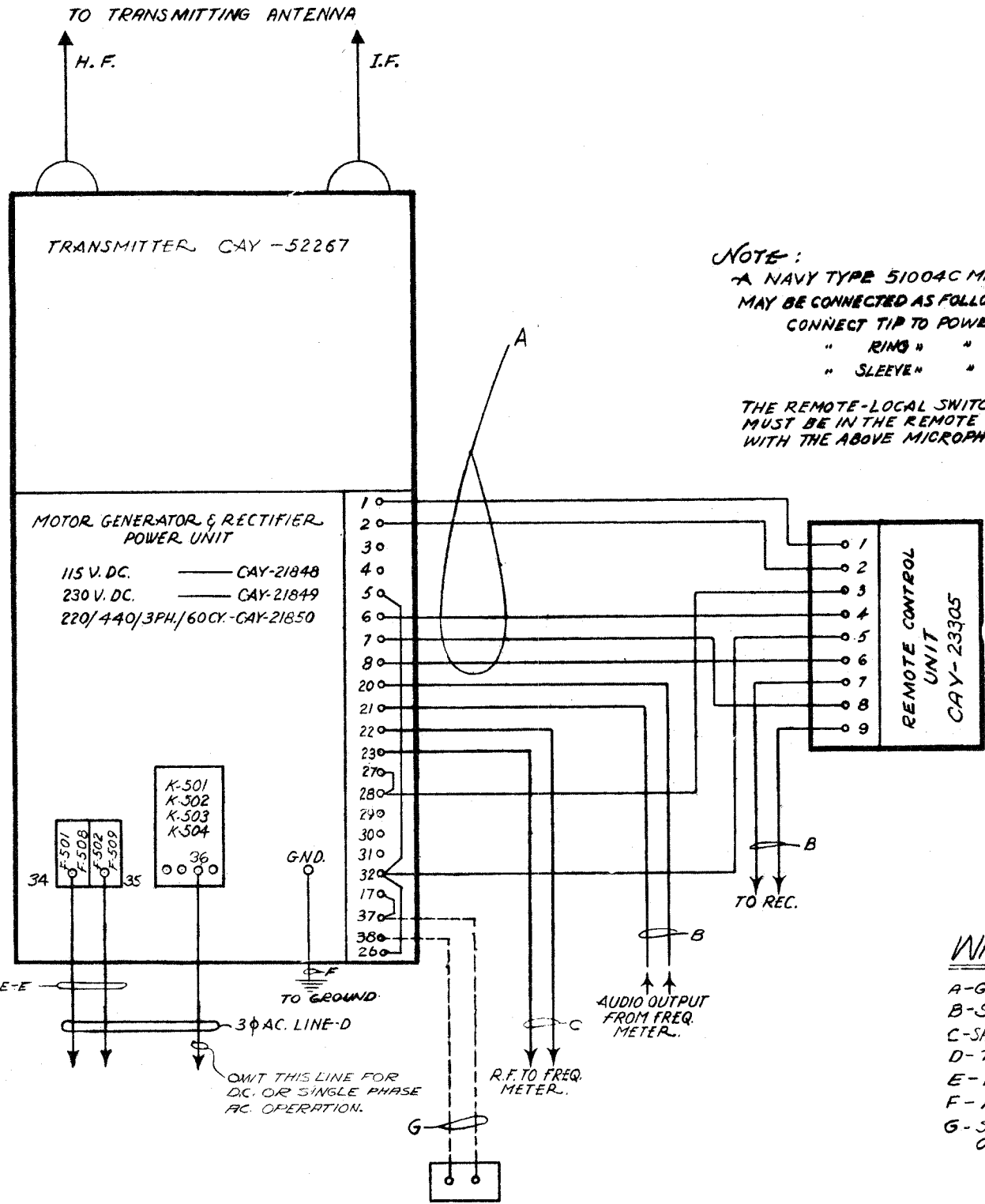

NOTE:
 A NAVY TYPE 51004C MICROPHONE
 MAY BE CONNECTED AS FOLLOWS IF DESIRED:
 CONNECT TIP TO POWER UNIT TERMINAL #7
 " RING " " " " " " " #8
 " SLEEVE " " " " " " " " #32

THE REMOTE-LOCAL SWITCH AT THE TRANSMITTER
 MUST BE IN THE REMOTE POSITION TO OPERATE
 WITH THE ABOVE MICROPHONE CIRCUITING.

TRANSMITTER LINK POSITIONS
 (SEE DWG 7300512 AND CONTROL UNITS
 SECTION IN INSTRUCTION BOOK)

LINK	CAY-23305
S-209	A TO B
S-210	A TO C
S-211	D TO E
S-212	A TO G

WIRE DESIGNATIONS

- A-GICA-14
- B-SRLL
- C-SHIELDED BELDON 76 CODE AIRMAN OR EQUIVALENT (.170" OD)
- D-TLPA-4
- E-DLPA-5
- F-1/8" X 1" COPPER STRAP
- G-STANDARD #14 RUBBER INSULATED WIRE OR EQUIVALENT

CONNECTION
 FOR FIELD RHEOSTAT
 WHEN REMOVED FROM
 POWER UNIT

Figure 8-33—Westinghouse Control Unit Interconnection
 Diagram for Navy Model TDE. (Dwg. 7709051)

RESTRICTED

RESTRICTED

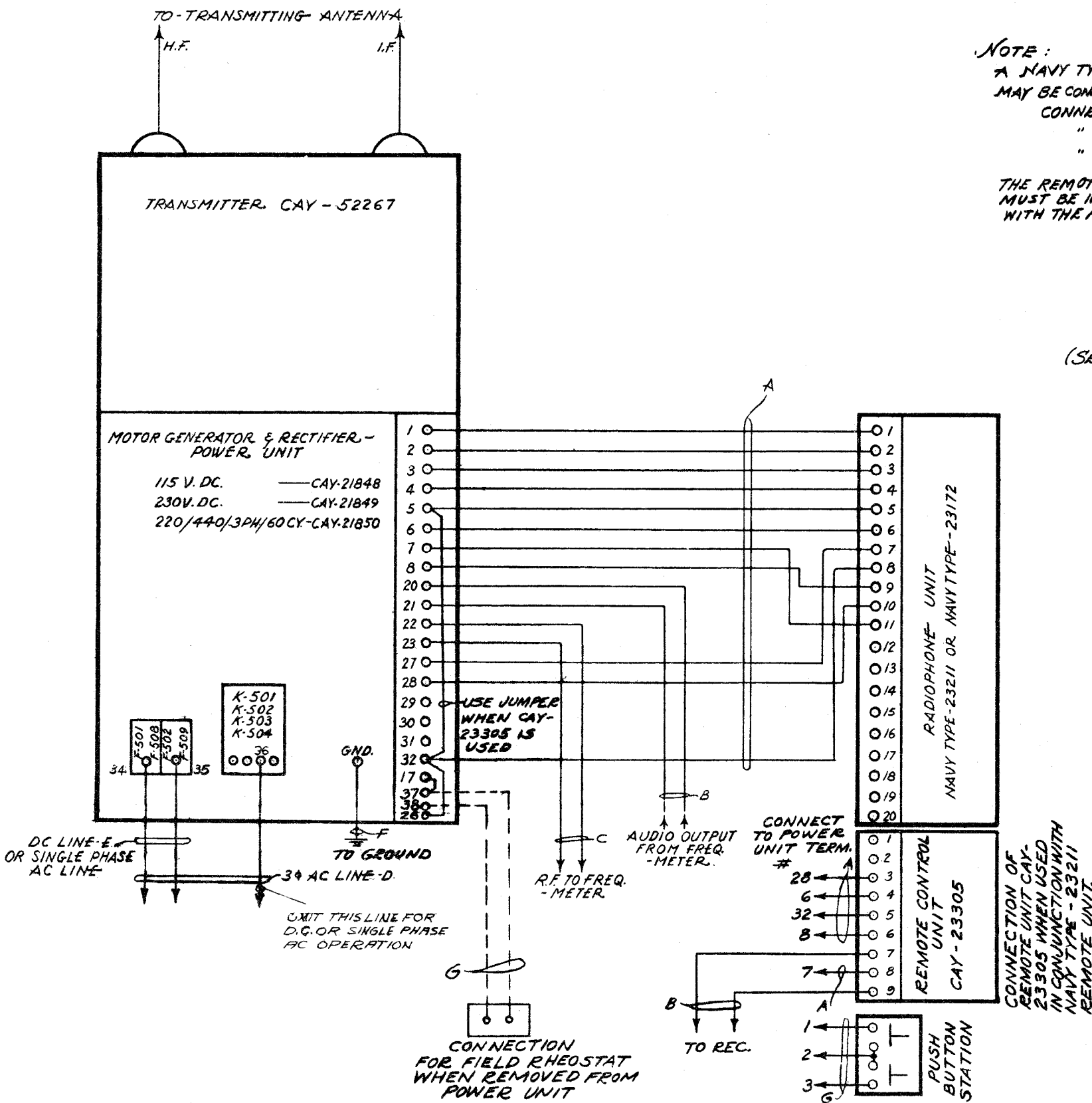

NOTE:
 A NAVY TYPE 5100-4C MICROPHONE
 MAY BE CONNECTED AS FOLLOWS IF DESIRED:
 CONNECT TIP TO POWER UNIT TERMINAL #7
 " RING " " " " " #8
 " SLEEVE " " " " " #32

THE REMOTE-LOCAL SWITCH AT THE TRANSMITTER
 MUST BE IN THE REMOTE POSITION TO OPERATE
 WITH THE ABOVE MICROPHONE CIRCUITING.

TRANSMITTER LINK POSITIONS
 (SEE DWG-7300512 AND CONTROL UNITS
 SECTION IN INSTRUCTION BOOK).

LINK	6-WIRE
S-209	A to B
S-210	A to B
S-211	D to E
S-212	A to C

WIRE DESIGNATIONS

- A - GICA-14
- B - S RLL
- C - SHIELDED BELDON #16 CODE "AIRMAN" OR EQUIVALENT (170" OD)
- D - TLPA-4
- E - DLPA-5
- F - 1/8" X 1" COPPER STRAP.
- G - STANDARD #14 RUBBER INSULATED WIRE OR EQUIVALENT

CONNECTION OF
 REMOTE UNIT CAY-
 23305 WHEN USED
 IN CONJUNCTION WITH
 NAVY TYPE-23211
 REMOTE UNIT.

Figure 8-39—Navy Radiophone Unit, Interconnection Diagram for Navy Model TDE. (Dwg. 7709149)

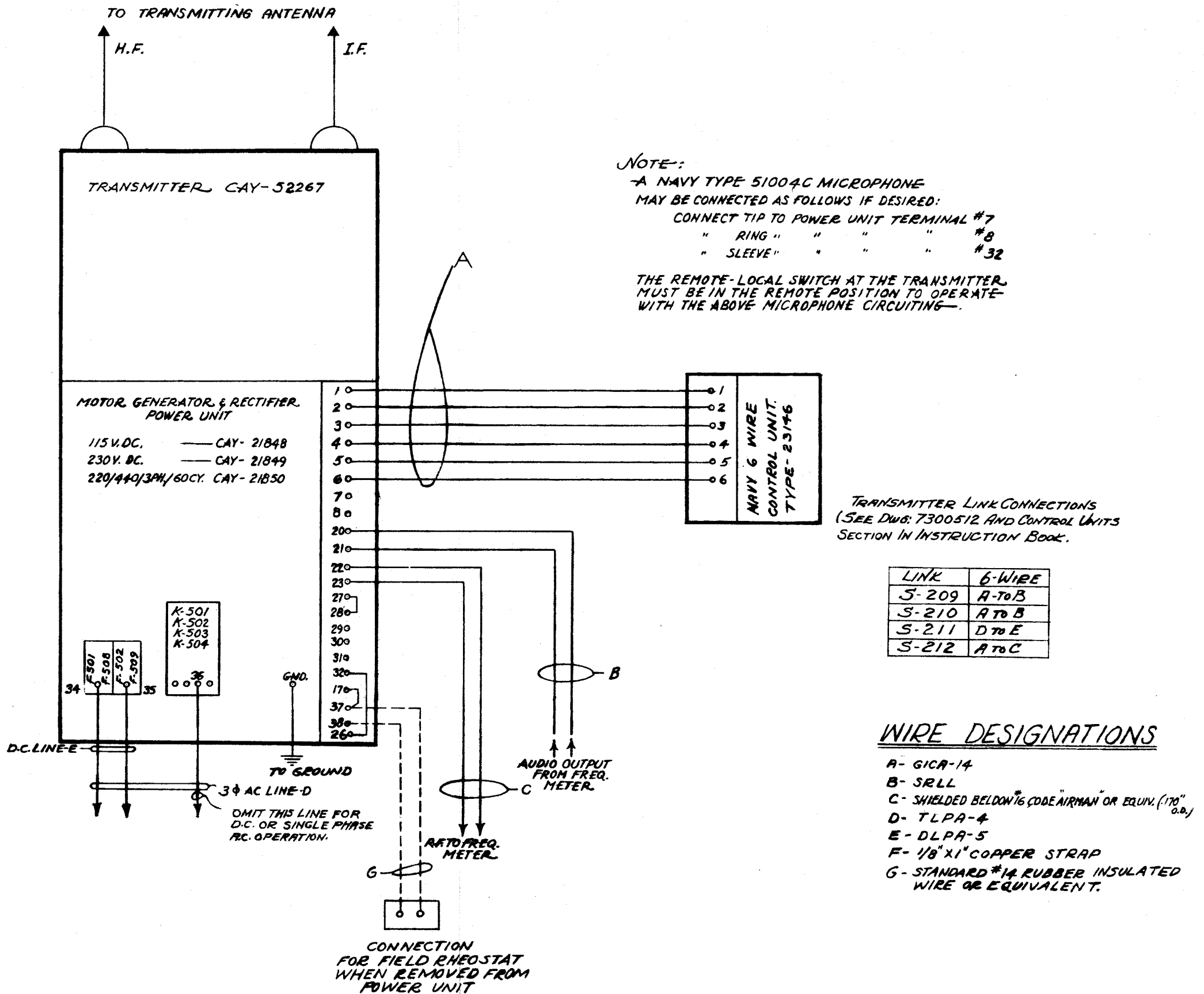

Figure 8-35—Standard Navy Six Wire Control Unit, Interconnection Diagram for Navy Model TDE. (Dwg. 7709052)

RESTRICTED

HIGH FREQUENCY MASTER OSCILLATOR CALIBRATION

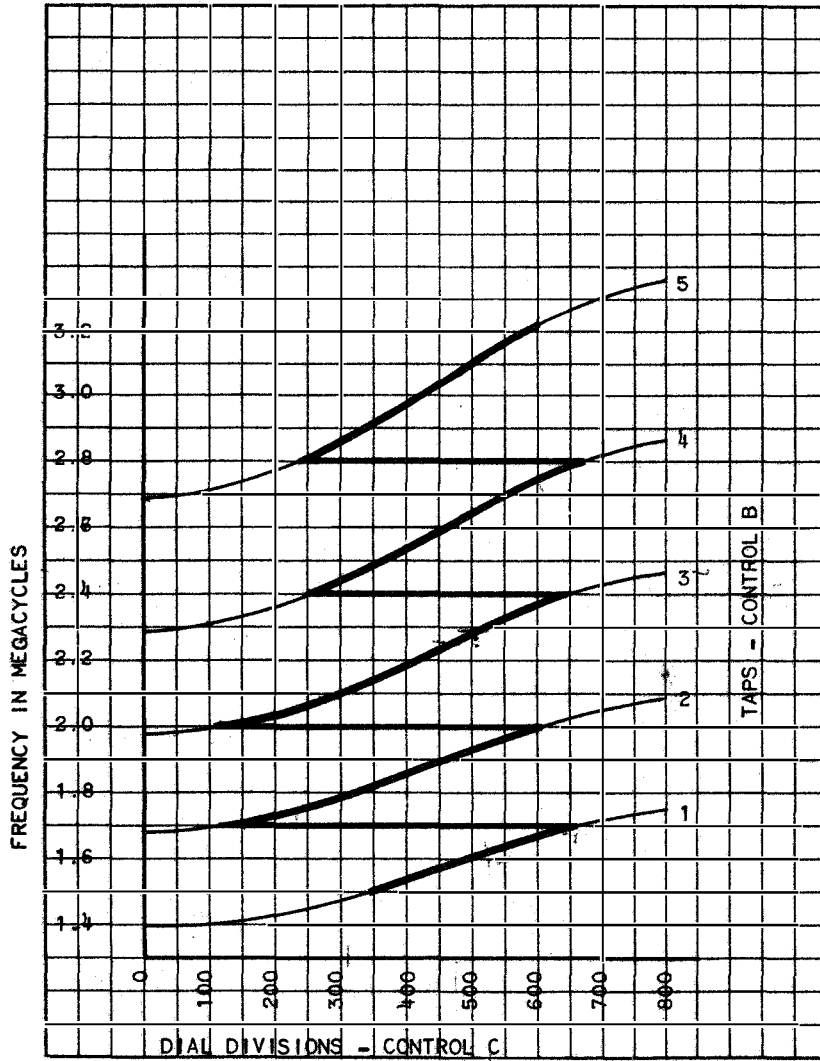

Figure 8-42—Tuning Curve for High Frequency Master Oscillator, Controls B and C. (Curve 271475)
(Approximate Readings Only)

HIGH FREQUENCY MULTIPLIER CALIBRATION

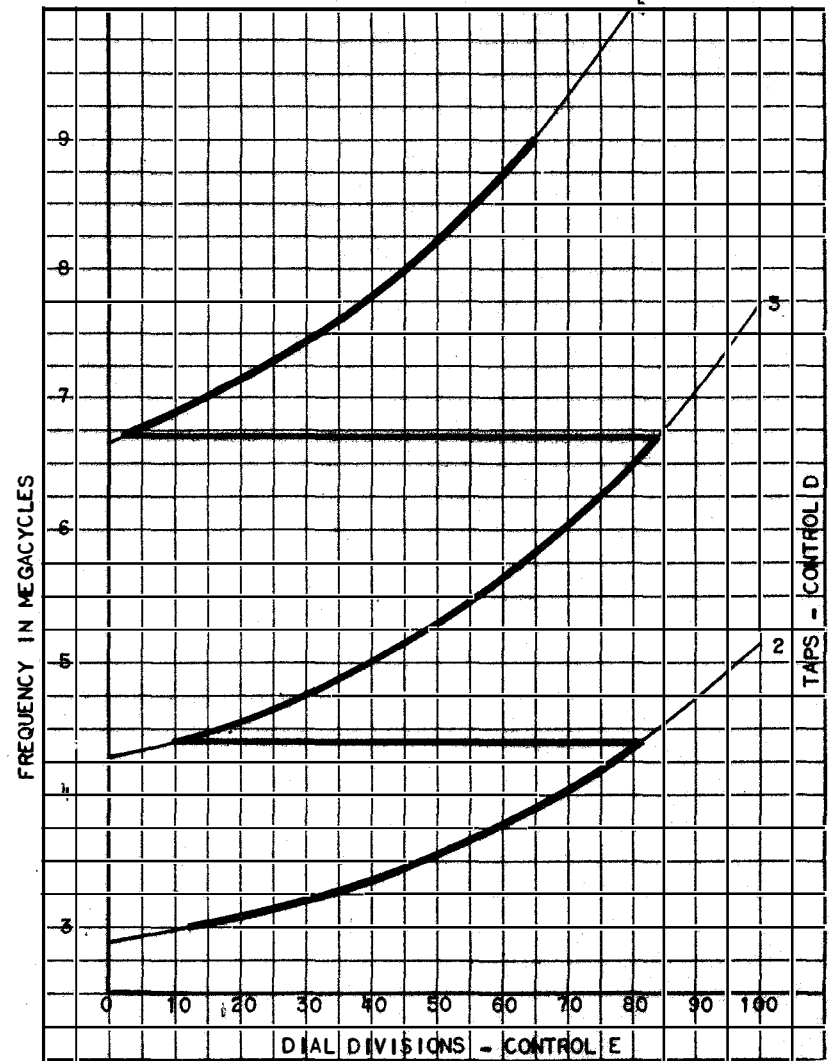

Figure 8-43—Tuning Curve for High Frequency Multiplier, Controls D and E. (Curve 271476)
(Approximate Readings Only)

8-65

RESTRICTED

Section VIII

HIGH FREQUENCY
INTERMEDIATE AMPLIFIER CALIBRATION

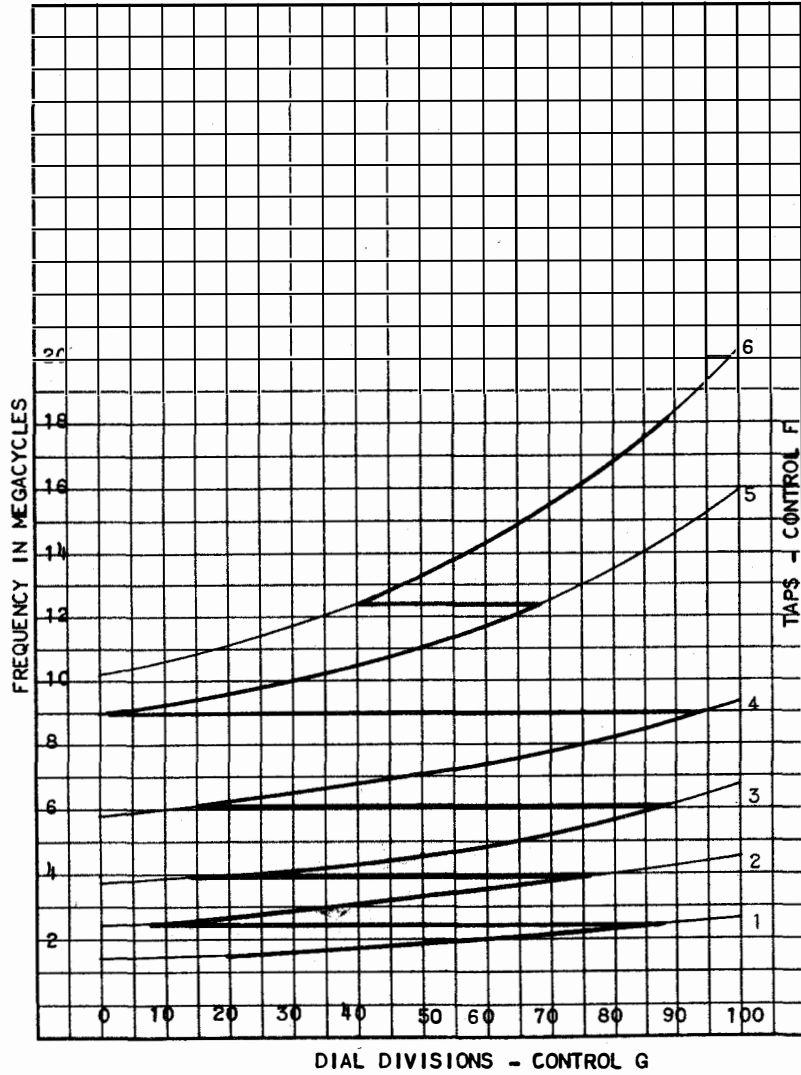

Figure 8-44—Tuning Curve for High Frequency Intermediate Amplifier, Controls F and G. (Curve 271477)
(Approximate Readings Only)

INTERMEDIATE FREQUENCY
MASTER OSCILLATOR CALIBRATION

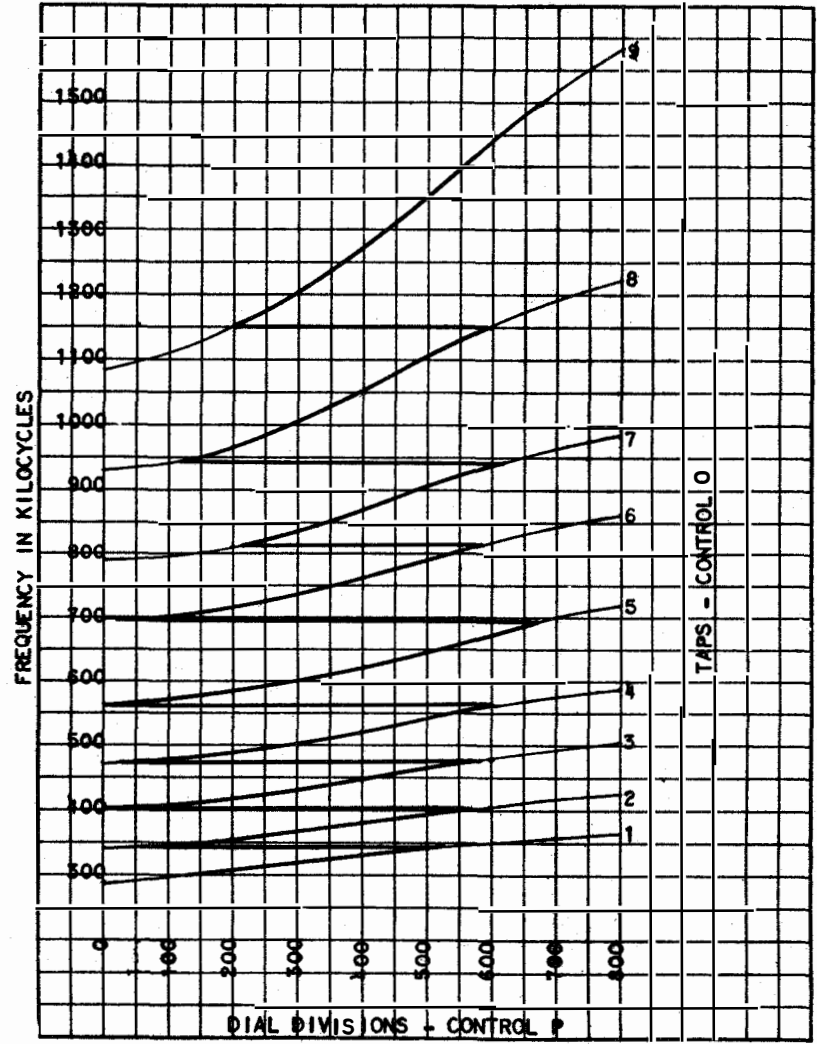

Figure 8-45—Tuning Curve for Intermediate Frequency Master Oscillator, Controls O and P. (Curve 271098)
(Approximate Readings Only)

RESTRICTED

RESTRICTED

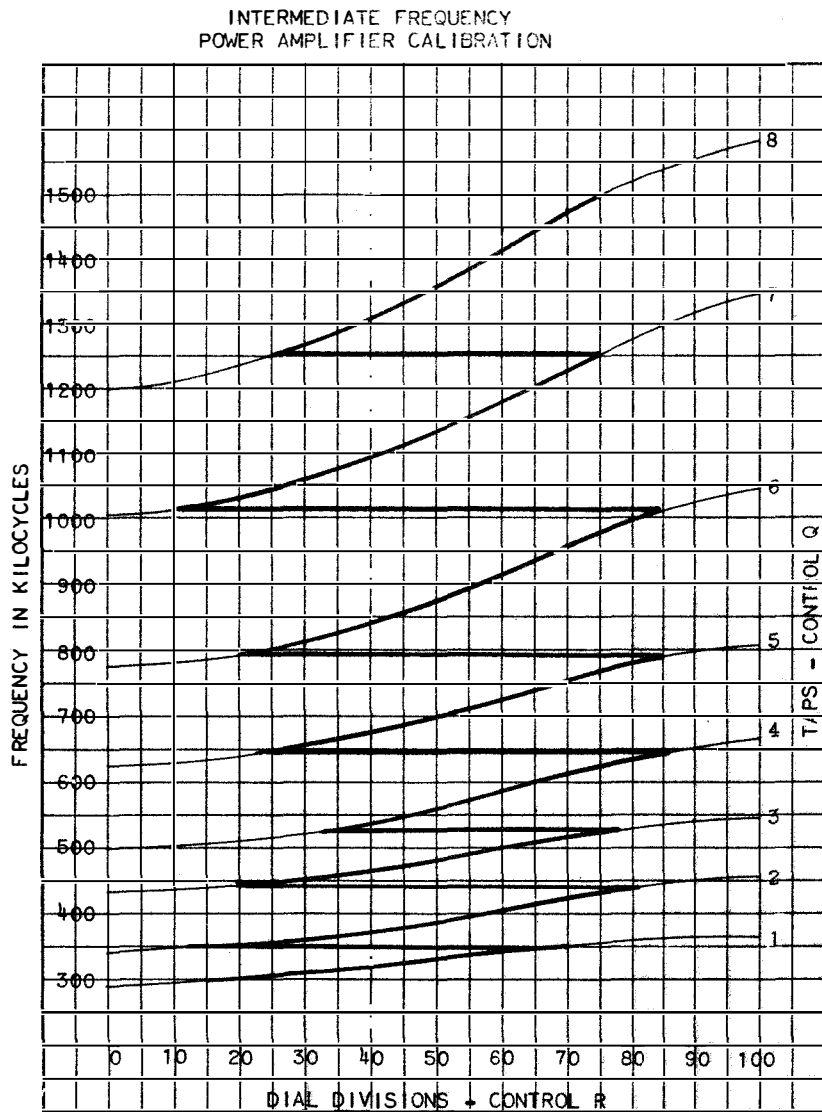
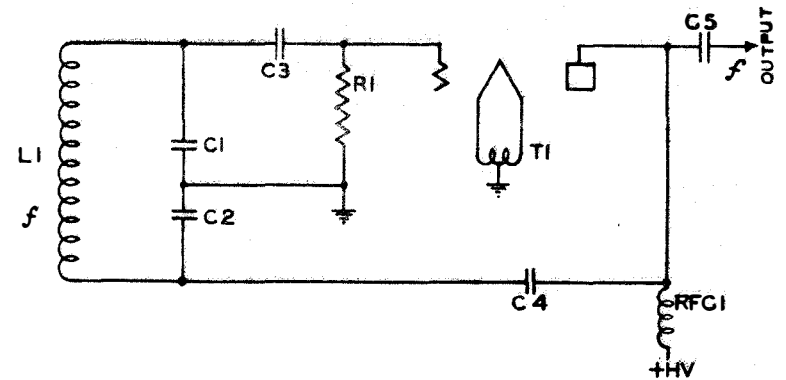

Figure 8-46—Tuning Curve for Intermediate Frequency Power Amplifier, Controls Q and R. (Curve 271099)
(Approximate Readings Only)



STANDARD COLPITTS OSCILLATOR CIRCUIT

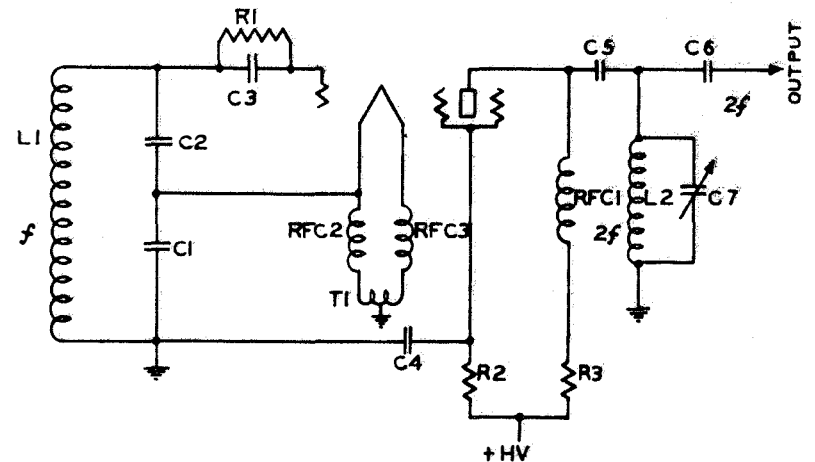

Figure 8-47—Standard Colpitts Oscillator Circuit and Electron Coupled Oscillator Circuit. (Dwg. 7705422)

POSITION OF VOLTAGE-CURRENT SWITCH
 (CONTROL T) FOR VARIOUS ANTENNA SYSTEM LENGTHS
 (CURVES ARE APPROX.- TO BE USED ONLY AS A GUIDE)
 I.F. RANGE

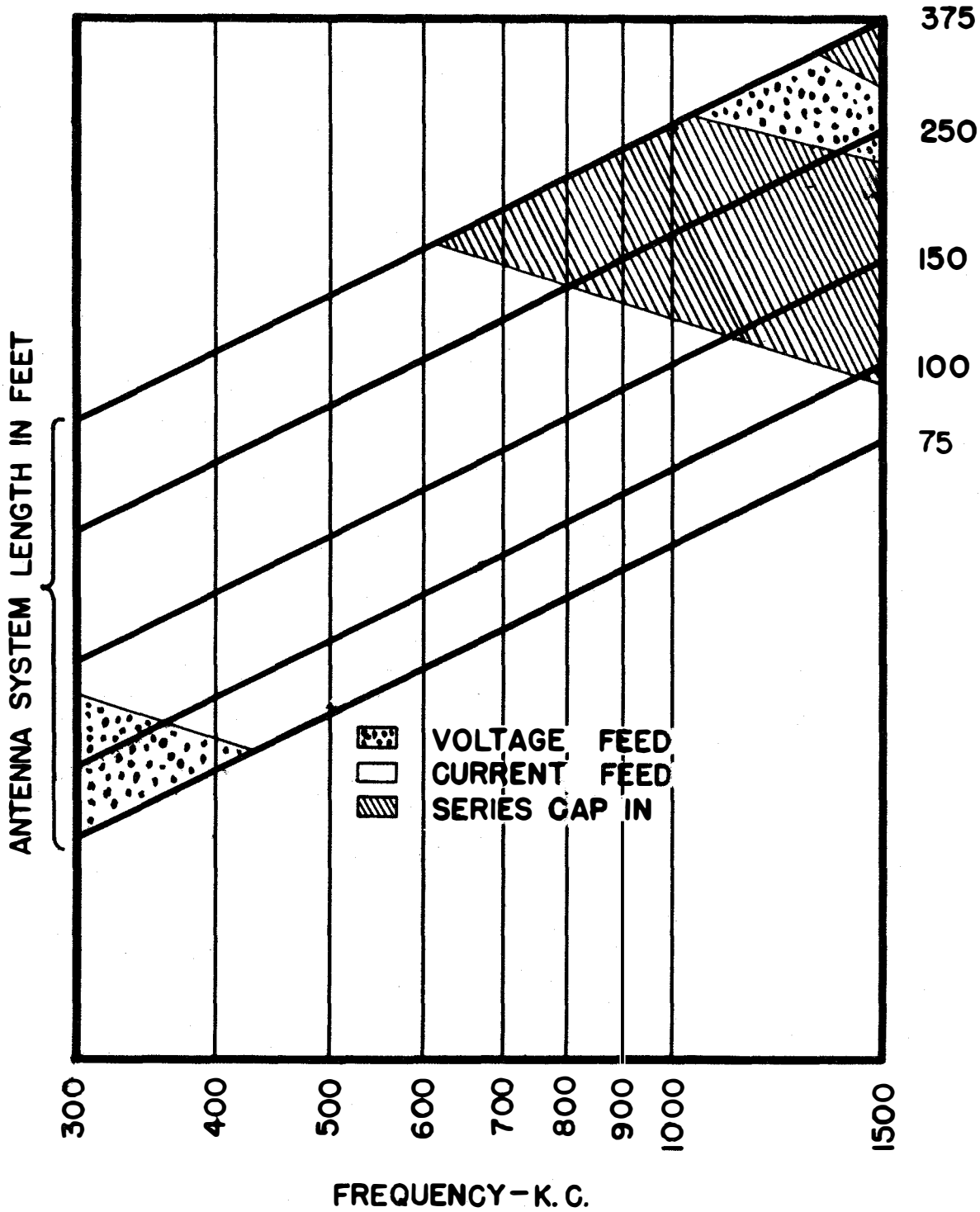

Figure 8-48—Antenna Characteristics, Intermediate Frequency Transmitter. (Dwg. 7709571)

POSITION OF VOLTAGE - CURRENT SWITCH
(CONTROL L) FOR VARIOUS ANTENNA SYSTEM LENGTHS
(CURVES ARE APPROX.- TO BE USED ONLY AS A GUIDE)
H.F. RANGE

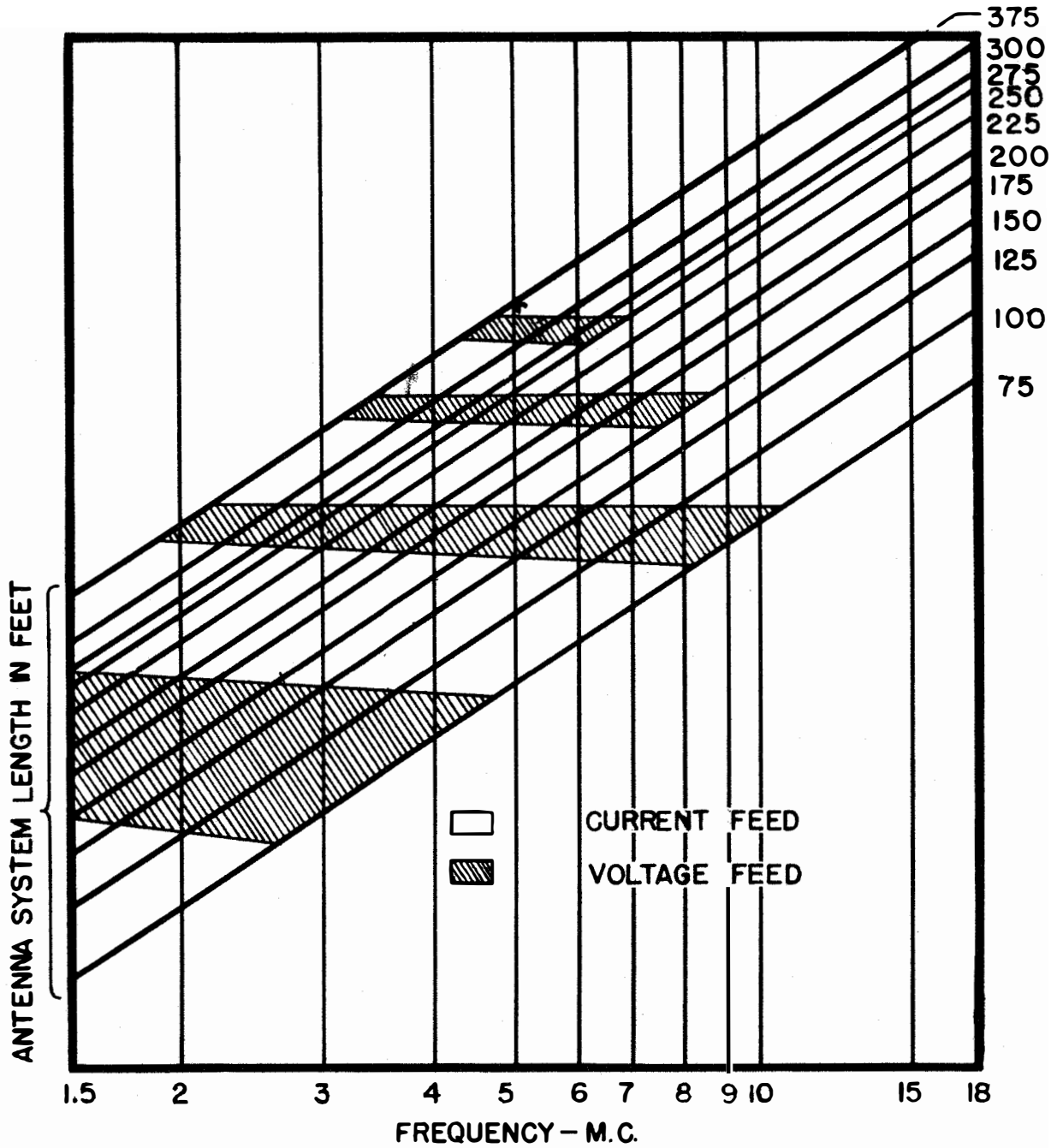
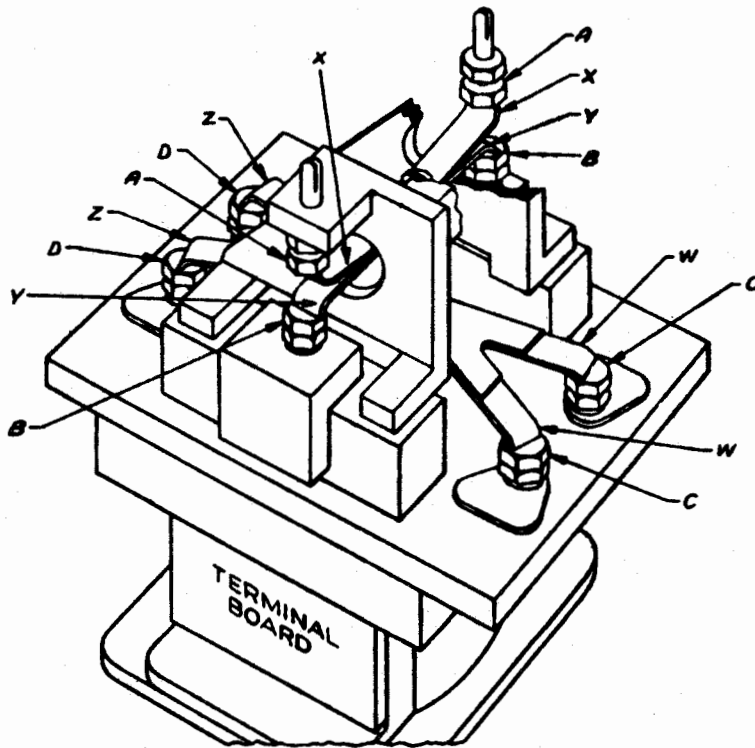

Figure 8-49—Antenna Characteristics, High Frequency Transmitter. (Dwg. 7709570)



KEYING RELAY ADJUSTMENT

The contact timing is adjusted as follows: Press plunger down until it bottoms. Then raise plunger .009 inches and adjust contacts (C-W) to just make. Raise plunger .001 inches and adjust contacts (D-Z), (Y-B), and (A-X) to just make. Final adjustment is to be made by observing keying waveform on oscillograph. The relay contacts shall close reliably and there shall be no chatter. Relays with plungers that strike bottom will be considered satisfactory, provided all other requirements are met. Stretching of guide springs, to remove slight breaks in keying waveform, is permissible.

Figure 8-50—Keying Relay Adjustments (Dwg. 7405832)

RELAY	OPERATING CURRENT	USE
K-201	None	Not Used
K-202	0.061 Amps.	Keying Relay
K-203	0.039 Amps.	Microphone Relay
K-501	0.150 Amps.	Main Line Contactor
K-502	0.072 Amps.	Main Line Contactor
K-503	0.300 Amps.	Main Line Contactor
K-504	0.300 Amps.	Main Line Contactor
K-505	14.00 Amps.	Thermal Overload Relay
K-506	14.00 Amps.	Thermal Overload Relay
K-507	8.00 Amps.	Thermal Overload Relay
K-508	8.00 Amps.	Thermal Overload Relay
K-509	4.50 Amps.	Thermal Overload Relay
K-510	4.50 Amps.	Thermal Overload Relay

Figure 8-51—Contactor and Relay Operating Table

METER READINGS I.F. RANGE

Freq. Kcs.	Emission	I.A. Ig. Ma.	P.A. Ig. Ma.	P.A. Ip. Ma.	Antenna Current		Antenna Watts Actual	
					I Int. Amps.	I Ext. Amps.		
300	CW	3.15	30	175	5.6	5.2	127	10
	MCW	3.15	32	96	4.3	3.9	71.5	28
	VOICE	3.15	32	100	2.9	2.8	36.0	25
400	CW	3.05	38	175	5.5	5.0	117	100
	MCW	3.05	40	101	4.5	3.9	71.5	28
	VOICE	3.05	40	96	2.7	2.4	27	25
500	CW	2.8	43	175	5.9	5.1	122	100
	MCW	2.8	45	95	4.2	3.7	64.2	28
	VOICE	2.8	45	100	3.0	2.5	29.4	25
600	CW	2.6	39	175	5.5	4.9	113	100
	MCW	2.6	41	96	4.0	3.5	57.8	28
	VOICE	2.6	41	104	2.9	2.5	29.4	25
1000	CW	2.6	49	175	5.2	4.6	99.5	80
	MCW	2.6	52	96	4.0	3.4	54.2	22
	VOICE	2.6	52	99	2.6	2.3	24.9	20
1500	CW	2.2	48	175	5.4	4.3	86.9	75
	MCW	2.2	51	101	4.3	3.4	54.2	20
	VOICE	2.2	51	91	2.4	2.0	18.8	18

Antenna Load = 750 mmfd. and 4.7 ohms.

DIAL READINGS

Freq. Kcs.	A	O	P	Q	R	S	T	U	V	W
300	IF	1	187	1	33	29	C	0	6	50
400	IF	2	547	2	60	22	C	0	7	80
500	IF	4	303	3	60	17	C	0	8	75
600	IF	5	276	4	62	16	C	0	9	60
1000	IF	8	302	7	3	26	C	0	10	96
1500	IF	9	660	8	73	25	SC	0	10	74

Figure 8-52. Typical Dial Settings and Meter Readings, Intermediate Frequency Range.

RESTRICTED

METER READINGS H.F. RANGE

q. cs.	Emission	I.A. Ig. Ma.	P.A. Ig. Ma.	P.A. I ₁ Ma.	Antenna Watts Actual	Watts Guar.
1500	CW	31	175	166	100
	MCW	...	29	120	136	28
	VOICE	28	110	54	25
3000	CW	4.3	41	175	168	125
	MCW	4.3	41	122	152	35
	VOICE	4.3	42	107	63	30
6000	CW	5.1	49	125	180	125
	MCW	5.1	49	120	158	35
	VOICE	5.1	51	105	58	20
8000	CW	1.7	42	175	184	125
	MCW	1.7	46	118	55	35
	VOICE	1.7	46	110	53	30
12000	CW	3.1	55	175	194	125
	MCW	3.1	39	115	136	35
	VOICE	3.1	39	110	63	30
18100	CW	2.3	35	175	190	100
	MCW	2.3	42	110	48	28
	VOICE	2.3	42	110	56	25

Antenna Load = 2-150 watt type C lamps in parallel.

DIAL READINGS

Freq. Kcs.	A	B	C	D	E	F	G	H	J	K	L	M	N
1500	HF	1	379	1	...	1	10	1	.8	35	C	46	0
3000	HF	1	379	2	12	2	44	5	4.8	31	C	81	0
6000	HF	5	439	3	68	3	85	5	15.6	31	C	100	100
8000	HF	4	534	4	43	4	64	5	18.3	36	C	100	2205
12000	HF	3	182	3	68	5	64	5	21.3	35	V	100	1865
18100	HF	5	463	4	65	6	78	5	23.3	22	V	100	2414

Figure 8-53. Typical Dial Settings and Meter Readings, High Frequency Range

RESTRICTED