

RESTRICTED

This instruction book is furnished for the information of commissioned, warrant, enlisted and civilian personnel of the Navy whose duties involve design, instruction, operation and installation of radio and sound equipment. The word "RESTRICTED" as applied to this instruction book signifies that this instruction book is to be read only by the above personnel, and that the contents of it should not be made known to persons not connected with the Navy.

GUARANTEE

All items used in this equipment, except vacuum tubes, will be guaranteed by the contractor for a period extending one year from the installation date of the equipment, provided that in no case will the guarantee extend longer than two years after the date of acceptance. This guarantee will cover items failing in normal operation and the contractor will replace these at no cost to the Government and with transportation charges prepaid to destination. If the contractor elects to have the defective unit returned to his plant for examination, he will be required to pay the transportation charges.

NOTICE

The model RAS-2 radio receiving equipment is identical to the model RAS radio receiving equipment. All references to the model RAS equipment in this instruction book apply to the model RAS-2 equipment.

TABLE OF CONTENTS

SECTION	SUBJECT	PAGE
1	GENERAL DESCRIPTION	1
2	DESCRIPTION OF MAJOR UNITS	1
3	TUBE COMPLEMENT	2
4	POWER REQUIREMENTS	2
5	ANTENNA REQUIREMENTS	3
6	INSTALLATION	3
7	TUBE LOCATION BY NAVY TYPE	5
8	CONSTRUCTION	5-8
	8.1 General	5
	8.2 Radio Receiver	5
	8.3 Power Units	7
	8.4 Loud Speaker	7
	8.5 Coil System Container	7
	8.6 Mounting Rack	7
	8.7 Net Weights	8
9	CIRCUIT DESCRIPTION	8-12
	9.1 Radio Receiver	8
	9.2 Power Units	10
	9.3 Loud Speakers	10
	9.4 Coil Sets	10
10	OPERATING INSTRUCTIONS	12-13
	10.1 Controls	12
	10.2 MCW Reception	13
	10.3 CW Reception	13
11	PERFORMANCE DATA	See Page
12	MAINTENANCE — FAILURES AND REMEDIES	21-22
	12.1 General	21
	12.2 Tube Replacements	21
	12.3 Failure of the Radio Receiver	21
	12.4 Failure of the Power Unit	22
	12.5 Failure of the Loud Speaker	22
13	TEST DATA	22-26
	13.1 Tube Socket Voltages and Cathode Currents	23-24
	13.2 Point to Point Resistances	24-25
	13.3 Stage Gain Measurements	26
14	ALIGNMENT DATA	26-29
	14.1 General	26
	14.2 I.F. Amplifier Alignment	26
	14.3 H.F. Oscillator Alignment	27
	14.4 R.F. Amplifier Alignment	28
	14.5 Tracking of H.F. Oscillator and R.F. Amplifier Circuits	28
15	PARTS LIST	30-57
	15.1 List of Major Units	30
	15.2 Parts List by Symbol Designation	31-49
	15.3 Parts List by Navy Type Numbers	50-52
	15.4 Spare Parts by Navy Type Designations	53-56
	15.5 List of Manufacturers	57
16	DIAGRAMS	See Page
17	PHOTOGRAPHS	See Page

DIAGRAMS AND PHOTOGRAPHS

PERFORMANCE DATA	14-20
Dwg. No. 11.1 Sensitivity vs. Frequency	14
Dwg. No. 11.2 Maximum Noise Level vs. Frequency	15
Dwg. No. 11.3 Selectivity Characteristics	16
Dwg. No. 11.4 Image Attenuation vs. Frequency	17
Dwg. No. 11.5 Fidelity Characteristic	18
Dwg. No. 11.6 AVC Characteristic	19
Dwg. No. 11.7 Dial Calibration	20

(Continued on next page)

SECTION	SUBJECT	PAGE
DIAGRAMS		
Dwg. No. 6.2	Mounting Rack Assembly	3
Dwg. No. 16.01	Outline Drawing of Model RAS Equipment	58
Dwg. No. 16.02	Outline Drawing of Radio Receiver	58
Dwg. No. 16.03	Outline Drawing of Power Units	58
Dwg. No. 16.04	Outline Drawing of Loud Speakers	59
Dwg. No. 16.05	Outline Drawing of Coil System Container	59
Dwg. No. 16.06	Outline Drawing of Mounting Rack	59
Dwg. No. 16.07	Outline Drawing of Typical Coil Set	59
Dwg. No. 16.08	External Wiring Connections	60
Dwg. No. 16.09	Schematic Wiring Diagram of RAS Equipment	61
Dwg. No. 16.10	Actual Wiring Diagram of Radio Receiver	62
Dwg. No. 16.11	Actual Wiring Diagram of Power Units	63
Dwg. No. 16.12	Actual Wiring Diagram of Loud Speakers	64
Dwg. No. 16.13	Actual Wiring Diagram of Coil Set No. 1.....	64
Dwg. No. 16.14	Actual Wiring Diagram of Coil Set No. 2	65
Dwg. No. 16.15	Actual Wiring Diagram of Coil Set No. 3	65
Dwg. No. 16.16	Actual Wiring Diagram of Coil Set No. 4	66
Dwg. No. 16.17	Actual Wiring Diagram of Coil Set No. 5	66
Dwg. No. 16.18	Actual Wiring Diagram of Coil Set No. 6	67
Dwg. No. 16.19	Actual Wiring Diagram of Coil Set No. 7	67
PHOTOGRAPHS		
Photo No. 1	Model RAS Equipment	iv
Photo No. 6.2	Mounting Rack	4
Photo No. 6.3	Rear View of Model RAS Equipment	4
Photo No. 8.209	Typical I.F. Transformer Assembly	6
Photo No. 17.01	Front View of Radio Receiver	68
Photo No. 17.02	Rear View of Radio Receiver	69
Photo No. 17.03	Front View of Type 20090 Power Unit	70
Photo No. 17.04	Internal View of Type 20090 Power Unit	70
Photo No. 17.05	Front View of Type 49105 Loud Speaker	71
Photo No. 17.06	Rear View of Type 49105 Loud Speaker	71
Photo No. 17.07	Front View of Coil System Container	72
Photo No. 17.08	Internal View of Coil System Container	72
Photo No. 17.09	Typical Coil Set (Set No. 5)	73
Photo No. 17.10	R.F. Transformer Set No. 5	73
Photo No. 17.11	R.F. Transformer Set No. 1	74
Photo No. 17.12	R.F. Transformer Set No. 2	74
Photo No. 17.13	R.F. Transformer Set No. 3	74
Photo No. 17.14	R.F. Transformer Set No. 4	75
Photo No. 17.15	R.F. Transformer Set No. 6	75

(Continued on next page)

TABLE OF CONTENTS (Continued)

PHOTOGRAPHS	SUBJECT	PAGE
Photo No. 17.16	R.F. Transformer Set No. 7	75
Photo No. 17.17	Bottom View of Radio Receiver ..	76
Photo No. 17.18	Top View of Radio Receiver	77
Photo No. 17.19	Front View of Type 49106 Loud Speaker	79
Photo No. 17.20	Rear View of Type 49106 Loud Speaker	79
Photo No. 17.21	Front View of Type 20089 Power Unit	80
Photo No. 17.22	Internal View of Type 20089 Power Unit	80

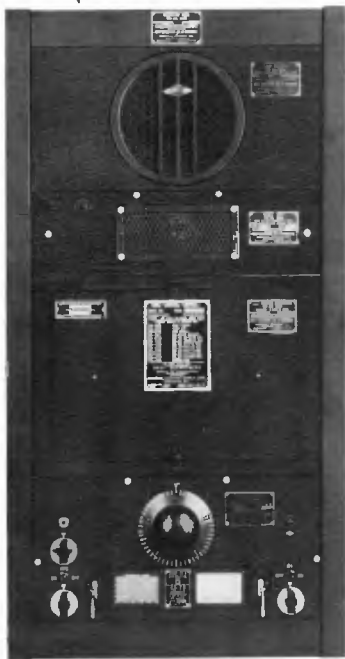

PHOTO NO. 1. MODEL RAS EQUIPMENT

1. GENERAL DESCRIPTION

1.1 The Model RAS Equipment is a complete radio receiving equipment suitable in all respects for use at Naval Radio shore stations or aboard Naval vessels.

1.2 The equipments are suitable for the reception of radio telephone or telegraph signals (either CW or MCW) by either head-phone or loud speaker methods.

1.3 The equipments are of the self-supported rack mounted type with racks suitable for table mounting.

1.4 The equipments are suitable for operation from 110/120 volts A.C., either 50/60 cycle or 25 cycle as may be designated on the name plate of the power unit.

1.5 Each complete equipment consists of the following major items:

Type CNA-46080 — Radio Receiver

Type CNA-20090 — Power Unit

Type CNA-49105 — Loud Speaker

Type CNA-10037 — Coil System Container

Type CNA-10036 — Mounting Rack

Type CNA-49106 Loud Speaker replaces Type CNA-49105 Loud Speaker for table mounting.

Type CNA-20089 Power Unit replaces Type CNA-20090 Power Unit for 25 cycle operation.

The seven Coil Sets used with the Type CNA-46080 Radio Receiver are as follows:

Type CNA-47156—Coil Set 1—190 to 450 KC.—Band 1

Type CNA-47157—Coil Set 2—450 to 900 KC.—Band 2

Type CNA-47158—Coil Set 3—.90 to 2.0 MC.—Band 3

Type CNA-47159—Coil Set 4—2.0 to 4.0 MC.—Band 4

Type CNA-47160—Coil Set 5—4.0 to 7.0 MC.—Band 5

Type CNA-47161—Coil Set 6—7.0 to 14.0 MC.—Band 6

Type CNA-47162—Coil Set 7—14.0 to 30.0 MC.—Band 7

Instruction books and one set of spare parts are supplied in addition to the major items listed above.

1.6 Net weights of all major items are listed in Par. 8.7. Overall dimensions are shown in Dwg. Nos. 16.01 to 16.07 inclusive.

2. DESCRIPTION OF MAJOR UNITS

2.1 The Type CNA-46080 Radio Receiver is a nine tube, rack mounted superheterodyne covering a continuous frequency range of from 190 to 30,000 kilocycles.

2.11 The circuit employed on all ranges comprises two stages of radio frequency amplification, first detector, high frequency oscillator, two stages of intermediate frequency amplification operating at 175 kilocycles, a bias type triode second detector and a resistance coupled audio output stage. The second detector tube utilizes one set of elements of a dual triode; the other set of elements is utilized for amplified and delayed automatic volume control. A beat frequency oscillator is coupled to the second detector to provide for CW reception.

2.12 Two audio output circuits are provided:

(1) A phone jack is mounted on the front panel. The output from this jack is approximately 10 milliwatts of undistorted audio power. The correct load impedance for the phone output circuit is 600 ohms. The phone jack is supplied from the secondary of an audio output transformer, the center tap

of the secondary being grounded to the chassis of the receiver. The jack is so wired that the loud speaker circuit is opened when the phone plug is inserted.

(2) Loud speaker terminals are provided at the rear of the receiver chassis. The undistorted audio power available at these terminals is nominally 2 watts. The correct load impedance for the speaker output circuit is 5000 ohms and the Types CNA-49105 and CNA-49106 Loud Speakers are fitted with coupling transformers correctly matching this value of impedance.

2.13 Antenna input terminals are located at the left side of the chassis. The input circuit is suitable for operation with either a single wire antenna or a balanced feed line.

2.14 The frequency range of 190 to 30,000 kilocycles is covered by seven plug-in coil sets as listed under Par. 1.5.

2.2 The Type CNA-20090 Power Unit is built to supply all power required by the Radio Receiver. It is designed for operation from a power source of 110/120 volts 50/60 cycles.

MODEL RAS RADIO RECEIVING EQUIPMENT

The Type CNA-20089 Power Unit is similar to the CNA-20090 except that it is built for operation from a 110/120 volt 25 cycle power source.

Both Power Units employ a power transformer with primary fuses, vacuum tube rectifier, Navy Type-38593, and a one-section filter circuit. Normal D.C. output is 240 volts at 70 milliamperes for the receiver B supply; A.C. output is 6.2 volts at 3.4 amperes for the receiver heater circuits.

2.3 The Type CNA-49105 Loud Speaker is a rack mounted dynamic speaker having an overall diameter of approximately eight inches. It is fitted with a 5000 ohm coupling transformer to match the receiver output, and voice coil impedances.

The Type CNA-49106 Loud Speaker is a table mounting dynamic speaker, having

electrical characteristics identical with the Type CNA-49105 Loud Speaker.

2.4 The Type CNA-10037 Coil System Container is an enclosed metal cabinet providing space for housing six plug-in coil sets.

2.5 The Type CNA-10036 Mounting Rack is built to accommodate standard nineteen inch relay rack panels and has a total panel capacity of thirty-five inches. Side trim strips are provided to cover panel slots and mounting screws.

2.6 The Coil Sets Types CNA-47156 to -47162, inclusive, are four-gang coil assemblies which plug into the Type CNA-46080 Radio Receiver. Seven Coil Sets are used to cover the 190 to 30,000 kilocycle frequency range, as listed under Par. 1.5.

3. TUBE COMPLEMENT

3.1 The tubes employed in the Type CNA-46080 Radio Receiver are as follows:

<u>Symbol (DWG)</u>	<u>Navy Type</u>	<u>Commercial Type</u>	<u>Function</u>
V-101	—38646	6D6	First R.F. Amplifier
V-102	—38646	6D6	Second R.F. Amplifier
V-103	—38636	6C6	First Detector
V-104	—38636	6C6	H.F. Oscillator
V-105	—38646	6D6	First I.F. Amplifier
V-106	—38646	6D6	Second I.F. Amplifier
V-107	—38768F	6F8G	Second Detector, AVC
V-108	—38636	6C6	C.W. Oscillator
V-109	6V6G ^o	Audio Amplifier

^o 6V6GT may be substituted

3.2 The tube employed in the Type CNA-20089 or the Type CNA-20090 Power Unit is as shown below:

<u>Symbol (DWG)</u>	<u>Navy Type</u>	<u>Commercial Type</u>	<u>Function</u>
V-201	—38593	5Z3	Rectifier (Full Wave)

4. POWER REQUIREMENTS

4.1 The Model RAS Radio Receiving Equipment is designed for operation from a 110/120 volt 50/60 or 25 cycle power source. Line current at 115 volts is .65 amperes. Normal power consumption is 70 watts.

4.2 The Type CNA-46080 Radio Receiver is designed for operation with a B supply potential of 240 volts with a maximum current drain of 70 milliamperes. Normal heater voltage at the power cable plug is 6.2

volts A.C. Total heater current is approximately 3.4 amperes.

4.3 The Types CNA-20089 and CNA-20090 Power Units deliver all necessary power for both plate and heater circuits, as specified under Par. 4.2.

4.4 The Type CNA-46080 Radio Receiver may be operated from batteries. Best economy of battery power with minimum sacrifice in performance will be had with

180 volt B supply, at which voltage the current drain is 50 to 55 milliamperes. The

heater supply may be a 6 volt storage battery.

5. ANTENNA REQUIREMENTS

5.1 The input circuit of the Type CNA-46080 Radio Receiver is so arranged as to be suitable for use with either a balanced feed-line or a simple antenna-ground combination.

5.2 The input impedance averages 500 ohms when using Coil Sets Types CNA-47159 to -47162, inclusive, having a total frequency range of from 1700 to 30,000 kilocycles. Coil Sets Types CNA-47156 to -47158, inclusive, have higher values of input impedance but in no case does the impedance exceed 5000 ohms.

5.3 The antenna input terminals E-101 are located at the left-hand side of the receiver chassis when viewed from the front. Two insulated binding posts are provided together with a short length of flexible lead permanently attached to the receiver chassis which allows either input terminal to be grounded if required.

5.4 In an installation having a simple antenna-ground combination, connect the single wire lead-in to either of the two input

terminals, and ground the other terminal to the chassis by means of the flexible lead, referred to in Par. 5.3. It is recommended that the Mounting Rack of the Model RAS Equipment be permanently grounded but, if such an arrangement is impractical, the ground lead may be attached directly to the input terminal which is connected to the chassis. The dimensions of the single wire antenna system are not at all critical: the recommended minimum overall length of antenna and lead-in is fifty feet; the recommended maximum overall length is two hundred feet.

5.5 In an installation having a balanced feed-line, connect the two leads directly to the two input terminals. The chassis grounding lead, referred to in Par. 5.3, is not used.

5.6 In an installation having a concentric feed-line, connect the inner conductor to one of the terminals and the outer conductor to the other input terminal. Connect the latter to the chassis by means of the flexible lead.

6. INSTALLATION

6.1 The Model RAS Radio Receiving Equipment is shipped unassembled, each major unit being packed in a separate container. Spare Parts, including spare tubes, are packed separately.

6.2 After unpacking all units, assemble the Type CNA-10036 Mounting Rack; after assembly, it may be permanently installed in the operating position. Dwg. No. 6.2 supplies complete data covering the construction and assembly of the Mounting Rack.

6.3 Assemble each of the associated major units in the Mounting Rack, as shown in Dwg. No. 16.01. Machine screws are supplied with each major item for fastening the front panels to the side members of the Mounting Rack. Side trim strips, which cover the panel slots and mounting screws, complete the assembly.

6.4 Make interconnections between major items of the equipment shown in Dwg.

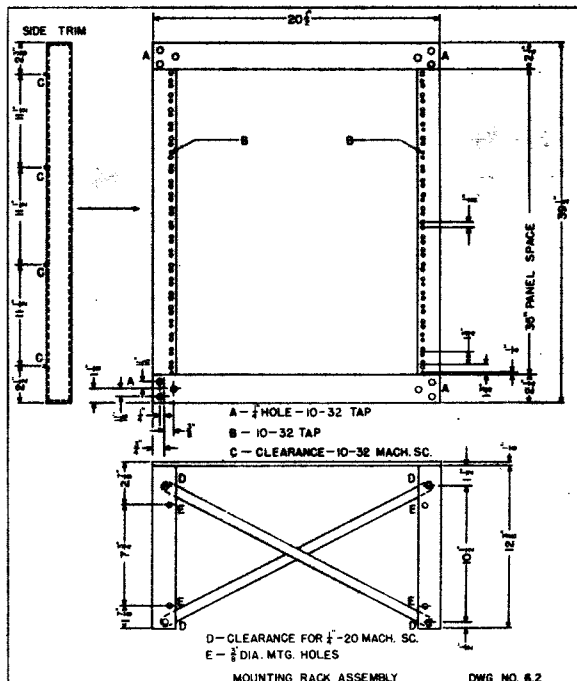

MODEL RAS RADIO RECEIVING EQUIPMENT

No. 16.08 as follows: Insert the cable plug P-101 of the Type CNA-46080 Radio Receiver in the output socket J-202 of the Type CNA-20089 or CNA-20090 Power Unit and fasten the shield grounding lug of cable W-101 under the thumb screw E-201 nearest the socket J-202. Connect the shielded leads of the Type CNA-49105 or Type CNA-49106 Loud Speaker to the speaker terminals E-107 of the Receiver; screw the shield grounding lug of cable W-301 to the chassis terminal E-108.

6.5 Insert plug P-202 in socket J-201 of the Type CNA-20089 or CNA-20090 Power Unit. Make connection to the proper 110, 120 volt A.C. source by means of connector cord W-201 and plug P-201.

6.6 Make antenna connections in accordance with Section 5, Antenna Requirements.

6.7 The radio frequency upon which reception is desired will determine the Coil

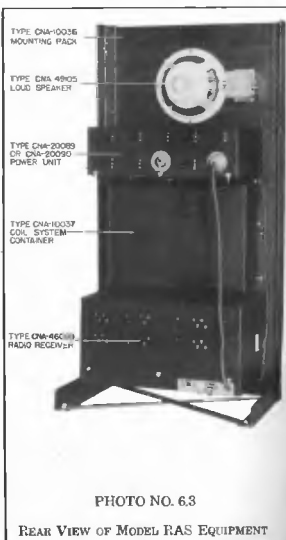
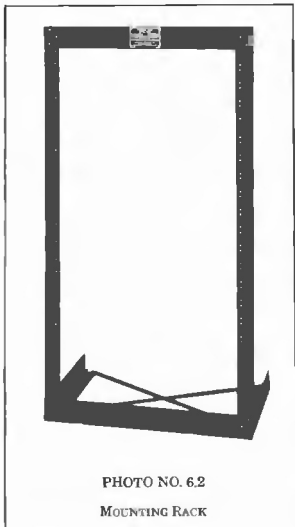

Set to employ, in accordance with the FREQUENCY CALIBRATION curves, Dwg. No. 11.7, or in accordance with the individual charts on each coil set panel. Select the proper Coil Set, and plug it into the opening in the front of the radio receiver, with the latch handles in the upper position. After the coil set has been pushed in as far as it will go, clamp it in place by swinging the latch handles to the extreme lower position.

6.8 The Equipment is now ready for operation and is turned on by means of a toggle switch S-201 on the front of the Power Unit.

6.9 A pair of terminals E-106 at the rear of the receiver chassis is wired to the B+ switch S-103. These terminals provide a convenient means of connecting a relay or switch for remote control.

7. TUBE LOCATION BY NAVY TYPE

7.1 The following table lists all tubes of the Model RAS Equipment by Navy Type Numbers.

<i>Navy Type</i>	<i>Commercial Type</i>	<i>Function</i>	<i>Symbol (DWG)</i>
—38593	5Z3	Rectifier	V-201
—38636	6C6	First Detector	V-103
—38636	6C6	H.F. Oscillator	V-104
—38636	6C6	C.W. Oscillator	V-108
—38646	6D6	First R.F. Amplifier	V-101
—38646	6D6'	Second R.F. Amplifier	V-102
—38646	6D6	First I.F. Amplifier	V-105
—38646	6D6	Second I.F. Amplifier	V-106
—38768F	6F8G	Second Detector, AVC	V-107
.....	6V6G ^o	Audio Amplifier	V-109

^o 6V6GT may be substituted

8. CONSTRUCTION

8.1 GENERAL

8.11 All items of the Model RAS Radio Receiving Equipment are ruggedly constructed of the best material known to be suitable for each specific employment.

8.12 All materials entering into its construction are, insofar as is practicable, resistant to the corrosive action of moist sea atmosphere or are suitably protected therefrom.

8.13 All soldered joints are secure and are covered with a colored lacquer which protects exposed metal parts of the joints from corrosion. Rosin flux is used exclusively for soldering.

8.14 All steel chassis, dust covers, cabinets and similar steel parts are copper-plated underneath a baked enamel finish so that the steel will be protected against corrosion should the painted surface become injured.

8.15 Provision for ventilation is made by the use of ventilating holes and louvres.

8.16 All major parts and spare parts are interchangeable without modification with similar parts employed in the construction of other equipments and are suitably marked to permit identification for ordering purposes.

8.17 Stainless steel lock washers are used on all steel screw heads and nuts. Bronze lock washers are used under brass nuts or between brass and ceramic surfaces.

8.18 All wiring is color coded in order to facilitate testing and the location of faults. Flexible wire is rubber covered with an overall silk braid.

8.19 Front panels of all component units have a Navy Standard black wrinkle finish. Dust shields and other exposed metal parts are finished with flat black enamel.

8.2 THE TYPE CNA-46080 RADIO RECEIVER

8.201 The Receiver is designed for relay rack mounting, the chassis and all component parts being supported by the front panel. See Photos Nos. 17.02 and 17.18.

8.202 The sides, top and back of the receiver are protected by a steel dust cover which is attached to the front panel by knurled thumb screws. The bottom of the chassis is fitted with a steel cover plate held in place by machine screws. The dust cover may be removed without taking the Receiver out of the mounting rack. The Receiver must be removed from the rack in order to detach the bottom plate.

8.203 The Receiver panel layout is shown in Photo No. 17.01. The locations and functions of the various controls are described in Sec. 10, Operating Instructions.

8.204 Any one of seven tuning ranges may be selected by inserting the proper plug-in Coil Set into a compartment in the receiver chassis through a rectangular opening in the front panel. The Coil Set in use may be "dogged" in place by means of eccentric latches located at either side of the panel

opening. Both receiver and Coil Sets are fitted with handles to facilitate band changing.

8.205 Each plug-in Coil Set comprises four shielded tuning inductors and their associated padding capacitors and air-dielectric trimmer capacitors. Low loss phenolic or polystyrene forms are employed to support all radio frequency coils. The general construction of a complete Coil Set is shown in Photo No. 17.09. The internal construction of R.F. transformer units is shown in Photos Nos. 17.10 to 17.16 inclusive.

8.206 Each inductor unit of each coil set has five coin silver contact buttons which engage with silver surfaced spring contact fingers mounted on the receiver chassis.

8.207 The main tuning capacitor is of the four gang in line type with 180° rotation for maximum capacitance change. Stator plates are supported by Isolantite insulators. Contact to the rotors is made by means of spring fingers carrying coin silver contact buttons which make sliding contact with coin silver collector rings welded to the ends of the individual rotor plate assemblies.

8.208 The main tuning capacitors are driven by a worm, the shaft of which carries the main tuning dial. This worm engages a split spring loaded worm gear, the step-down ratio of the combination being 20:1. The tuning dial is marked with 50 divisions spaced approximately $\frac{1}{4}$ of an inch apart. This dial makes ten complete revolutions in turning the tuning capacitors through 180°. A system of epicyclic gearing changes the dial scale numbering so that the correct numbers for every ten dial divisions appear progressively as the dial is rotated. The numbers are framed by small windows in the dial face so that only the correct numbers are visible at any time. This system of indexing provides a dial which is direct reading to 1 division in 500 with a maximum readable accuracy of 1 part in 2500.

8.209 The intermediate frequency transformers have conventional tuned primaries and tuned secondaries. Tuning capacitors are of air-dielectric construction and are mounted on ceramic bases. Primary and secondary inductors are "universal" wound on ceramic cores. The internal construction of a typical I.F. transformer is shown in Photo No. 8.209.

8.210 All tube sockets are of ceramic construction.



PHOTO NO. 8.209

TYPICAL I.F. TRANSFORMER ASSEMBLY

8.211 All component parts which may require removal in the event of damage to or failure of the receiver are mounted with machine screws and are fitted with terminal panels (if required) to facilitate replacement.

8.212 Pressure contact joints in R.F. and I.F. circuits have been eliminated insofar as is practicable. To this end, screws, studs, nuts, etc., carrying R.F. currents are soldered to provide a completely bonded metallic circuit. Soldered connections in R.F. inductor units and I.F. transformers are coated with polystyrene lacquer.

8.213 With one exception (C-110) all fixed capacitors of less than .01 mfd. are of molded mica construction. Capacitors of .01 mfd. or larger are of the metal case hermetically sealed oil impregnated type.

8.214 All fixed resistors, except R-139, have a ceramic body fused to a central carbon resistance element. They are

marked with the R.M.A. color code. Resistor R-139 is wire wound on a fiber form.

8.215 The headphone coupling transformer is vacuum wax impregnated and sealed in a metal container with high melting point compound.

**8.3 TYPES CNA-20089 AND CNA-20090
POWER UNITS**

8.31 The construction of these Power Units is identical except for the power transformers. Provision is made on all chassis to mount either the 25 cycle or 50/60 cycle transformer.

8.32 The chassis and all component parts are supported by a steel rack mounting panel, as shown in Photo No. 17.04.

8.33 Sides, top and back of the power unit are protected by a ventilated dust shield. The dust shield is held in place by knurled thumb screws and may be removed without taking the power unit out of the mounting rack.

8.34 Access to the rectifier tube and line fuses is provided by an opening in the front panel. This opening is normally covered by a metal grille work attached to the panel by four knurled thumb screws.

8.35 A recessed male connector for AC power input is mounted at the rear of the chassis. B supply and 6.2 volt heater supply circuits terminate at a four prong socket at the rear of the chassis. Both input and output terminals are accessible through openings in the dust shield.

8.36 The power transformer and filter reactor are mounted in individual cases. They are protected from the effects of humidity by a moisture resistant compound which seals each case. All leads of the power transformer and filter reactor are brought to soldering lugs on terminal panels permanently attached to the respective cases.

8.37 All component parts are attached to the chassis by machine screws or nuts for ease of removal in servicing.

8.4 TYPE CNA-49105 LOUD SPEAKER

8.41 The Loud Speaker is of the dynamic cone type mounted on a rack panel. Construction is shown in Photos Nos. 17.05 and 17.06. The nominal diameter of the loud speaker proper is 8 inches.

8.42 The panel is provided with a 6¾ inch hole in front of the speaker cone which is protected by a heavy metal grille.

8.43 An impedance matching transformer, "potted" in a metal case, is attached

to the rear of the speaker panel. It is fitted with terminal panels which carry soldering lugs.

8.44 A two-wire shielded cable is permanently attached to the coupling transformer and provides for connection to the speaker output terminals of the CNA-46080 Radio Receiver.

8.45 A cabinet type Loud Speaker, Type CNA-49106, for table mounting may be furnished, in some cases, as an auxiliary unit of the model RAS Equipment. Cabinet dimensions are shown in Dwg. No. 16.04. The loud speaker chassis and matching transformer are identical with those of the Type CNA-49105 Loud Speaker. See Photo Nos. 17.19 and 17.20.

**8.5 THE TYPE CNA-10037 COIL SYSTEM
CONTAINER**

8.51 The Coil System Container is a rack mounted cabinet having six rectangular compartments for housing unused Coil Sets. See Photo Nos. 17.07 and 17.08.

8.52 The compartments are accessible through a rectangular opening in the panel. This opening is provided with a door hinged at the upper edge. The door must be opened through an angle of approximately 90° to allow removal or insertion of Coil Sets. A catch is provided to hold the door in the open position. A spring latch is provided to hold the door closed.

8.53 Coil Sets are housed in the compartments with their name-plates toward the front so that the complete front panels of all coil sets are visible when the door is open.

8.54 A padded cross-piece is attached to the inside of the door and serves to hold the Coil Sets firmly in place in the compartments when the door is closed.

**8.6 THE TYPE CNA-10036 MOUNTING
RACK**

8.61 The Mounting Rack is constructed with 1½" x 2" angle iron side pieces and footing, with cross-pieces at both top and bottom. This construction is shown in Photo No. 6.2.

8.62 The Mounting Rack is built to accommodate standard 19 inch relay rack panels and has a total panel capacity of 35 inches. Side trim strips are provided to cover panel slots and mounting screws.

8.63 Both side members have 10/32 tapped holes for mounting the major items of the equipment. These holes have the standard spacing of ½ inch and 1¼ inch on centers, alternately.

MODEL RAS RADIO RECEIVING EQUIPMENT

8.7 NET WEIGHTS

Type CNA-46080 Radio Receiver (with one coil set)	35 lbs.
Type CNA-20090 Power Unit	22 lbs.
Type CNA-49105 Loud Speaker....	9 lbs.
Type CNA-10037 Coil System Container (Including Six Coil Sets)	26 lbs.
Type CNA-10036 Mounting Rack	27 lbs.
Type CNA-20089 Power Unit	27 lbs.

Type CNA-49106 Loud Speaker..	11 lbs.
Spare Parts (cased) for Equipments with Type —20090 Power Unit	21 lbs.
Spare Parts (cased) for Equipments with Type —20089 Power Unit	26 lbs.
Total Weight of Equipment, including Spare Parts, with Type —20090 Power Unit	140 lbs.
Total Weight of Equipment, including Spare Parts, with Type —20089 Power Unit	150 lbs.

9. CIRCUIT DESCRIPTION

9.1 TYPE CNA-46080 RADIO RECEIVER

9.11 The actual wiring diagram of the Type CNA-46080 Radio Receiver is shown in Dwg. No. 16.10.

The actual wiring diagram of the seven Coil Sets Types CNA-47156 to CNA-47162, inclusive, are shown in Dwg. Nos. 16.13 to 16.19 inclusive.

For purposes of illustration, it will be assumed that Coil Set Type CNA-47156 is in use, symbol numbers of circuit elements in the Coil Set will, therefore, refer to Dwg. No. 16.13.

9.12 Signal input to the receiver through terminals E-101 is connected to the first R.F. amplifier transformer assembly T-401 by contactor strip E-102. Transformer L-401 is tuned by trimmer capacitor C-401 and by the first R.F. section C-101A of the main tuning capacitor C-101. The output of transformer L-401 is connected to the grid of the first R.F. amplifier tube V-101. The plate circuit of V-101 is connected through contactor strip E-103 to the second R.F. transformer assembly T-402. Transformer secondary L-403 is tuned by trimmer capacitor C-402 and by the second R.F. section C-101B of the main tuning capacitor C-101. The output of the second R. F. transformer is connected to the grid of the second R.F. amplifier tube V-102. Minimum bias for V-101 and V-102 is furnished by cathode resistors R-102 and R-104 respectively. The plate of V-102 is connected by contactor strip E-104 to the first detector transformer assembly T-403. Transformer L-404 is tuned by trimmer capacitor C-403 and by the first detector section C-101C of the main tuning capacitor C-101. The output of transformer L-404 is connected to the grid of the first detector tube V-103.

9.13 The H.F. oscillator circuit is of the so-called "electron coupled" type. The H.F. oscillator inductor L-405 is tuned by trimmer capacitor C-404 and by the H.F. oscillator section C-101D of the main tuning capacitor C-101 with parallel connected ca-

pacitors C-405 and C-406 in series. The latter capacitors are known as series padding or "lag" capacitors and are used to modify the tuning of the H.F. oscillator circuit so that it will maintain a fixed frequency difference of 175 kilocycles with the signal frequency circuits when the main tuning capacitor C-101 is varied from minimum to maximum capacity. H.F. oscillator potential obtained from the cathode of tube V-104 is coupled by means of capacitor C-110 to the screen grid of first detector tube V-103.

9.14 The plate voltage on first detector tube V-103 is normal (approximately 180 volts) but the screen voltage is considerably lower than the value applied in an amplifier application. The voltage reduction is obtained through the combination of resistors R-107, R-108 and R-109. Bias on the first detector tube V-103 is obtained from cathode resistor R-110 and is considerably higher than the value applied in an amplifier application. The combination of low screen voltage and high bias causes tube V-103 to operate on a non-linear portion of its grid-voltage-plate-current characteristic, with the result that R.F. signal voltage, applied to the control grid, heterodynes with the high frequency oscillator potential applied to the screen grid, producing a third R.F. potential the frequency of which is equal to the difference between signal and oscillator frequencies. This third frequency is the intermediate frequency of the receiver, i.e., 175 kilocycles.

9.15 I.F. potential from the first detector tube V-103 is coupled by I.F. transformer T-101 to the first I.F. amplifier tube V-105. I.F. transformer T-102 couples V-105 to the second I.F. amplifier tube V-106. I.F. transformer T-104 couples V-106 to the second detector tube V-107A. Minimum bias for V-105 and V-106 is furnished by cathode resistors R-114 and R-125 respectively. I.F. transformers T-101, T-102 and T-104 each employ tuned primaries and tuned secondaries. The characteristics of these transformers determine the minimum selectivity of the

receiver as a whole. The selectivity of the R.F. and first detector transformers has some effect upon the overall selectivity characteristic, however, tending to decrease bandwidth. Coil Sets Types CNA-47156 and CNA-47157, covering frequencies from 190 to 900 kilocycles, produce a noticeable narrowing of the overall selectivity characteristic as shown in Dwg. No. 11.3. Coil Sets Types CNA-47158 to CNA-47162, inclusive, do not contribute appreciably to the overall selectivity of the receiver.

9.16 The elements of the second detector tube V-107A are those of one triode of a dual triode tube type —38768F. The second detector is the biased triode type wherein the grid is biased close to cut-off by the voltage drop across resistor R-132. Upon reaching the second detector, the I.F. signal is demodulated, the modulation components passing on to the audio amplifier V-109. Resistor R-135 and capacitors C-135 and C-137 comprise a filter circuit which suppresses the 175 kilocycle component of the second detector output but allows modulation components to pass.

9.17 Associated with the second detector circuits is the CW oscillator tube V-108. The CW oscillator circuit normally operates at the 175 kilocycle intermediate frequency. It provides an R.F. potential with which an unmodulated I.F. signal at the second detector can heterodyne to produce an audible CW beat note. The frequency of the CW oscillator is determined by transformer T-103; the circuit is the "electron coupled" type. Two capacitors C-144 and C-145, in parallel, provide adequate capacity to make the frequency of the CW oscillator stable. The frequency of the CW oscillator circuit is adjustable within narrow limits by variable capacitor C-126 which is fitted with a panel control. This capacitor is connected between the cathode tap and the low potential end of T-103. This connection simplifies shielding and allows the use of a comparatively large variable capacitor to provide a small tuning change. CW oscillator potential from the plate of tube V-108 is coupled by means of capacitor C-128 to the grid of the second detector tube V-107A. For most efficient heterodyne action, the peak CW oscillator R.F. potential impressed upon the grid of V-107A should approach but not exceed the D.C. grid bias.

9.18 Automatic volume control action is provided by tube V-107B. The elements of V-107B are those of one triode of the dual triode type -38768F. A.V.C. tube V-107B is biased beyond cut-off by means of

resistors R-129, R-130 and R-131. These resistors are connected between the receiver chassis and B minus and carry the total B current drawn by the receiver, with the exception of the current drawn by audio tube V-109. Inasmuch as the plate current flow in A.V.C. tube V-107B is limited by plate resistor R-127 to a fraction of a milliamperere, the resistor network R-129, R-130 and R-131 provides essentially constant bias. The action of the A.V.C. circuit is as follows: I.F. signal potential from the output of transformer T-104 is impressed upon the grid of A.V.C. tube V-107B through the coupling capacitor C-140. As previously stated, the A.V.C. tube is biased beyond cut-off, but when sufficiently strong I.F. signal voltage peaks are impressed upon the grid plate current will flow through resistor R-127. The voltage drop across resistor R-127 is connected through common filter resistor R-126 to the control grids of tubes V-101, V-102, V-105 and V-106 through filter resistors R-101, R-103, R-112 and R-123, respectively. This voltage increases the bias on the grids of the four tubes mentioned above with the result that amplification in both R.F. and I.F. amplifiers is reduced, thus maintaining an essentially constant I.F. signal at the grid of the second detector V-107A. Since the plate current flow in A.V.C. tube V-107B tends to vary with the peaks of the I.F. signal voltage, capacitor C-130 is used to filter out voltage fluctuations which, if fed back to the R.F. and I.F. tubes, would produce distortion and oscillation. Capacitors C-102, C-103, C-107, C-117 and C-123 provide additional filtering and circuit isolation, at the same time completing R.F. ground returns for the various transformers to which they are connected.

As previously stated, resistors R-129, R-130 and R-131 bias A.V.C. tube V-107B beyond cut-off. The value of bias voltage determines the threshold level at which A.V.C. action starts and the difference between this bias voltage and the cut-off bias of A.V.C. tube V-107B is termed the "delay voltage". In order that the second detector tube V-107A may deliver an adequate signal to the audio amplifier before the A.V.C. limiting action starts, resistors R-129, R-130 and R-131 are chosen to produce a delay voltage of approximately 4 volts DC.

The output of the CW oscillator tube V-108 is necessarily coupled to the grids of both second detector and A.V.C. tubes; consequently, considerable A.V.C. voltage is developed when the CW oscillator is turned on. Under such conditions, the Receiver will be extremely insensitive and for this reason the A.V.C. switch S-102 must be turned off whenever the CW oscillator is used for CW reception.

9.19 The audio output tube V-109 supplies audio power to both headphone and loud speaker terminals, J-101 and E-107, respectively. The speaker terminals are connected directly in the plate circuit while the headphone jack is coupled to the plate circuit by transformer T-105. The headphone jack J-101 is so wired that the loud speaker terminals E-107 are disconnected and the phone output transformer T-105 with resistor R-138 are substituted when a headphone plug is inserted in the jack. Transformer T-105 has a turns ratio of 1:1, the necessary reduction in power for headphone operation being obtained by the use of resistor R-138, which constitutes a low impedance load for the audio output tube V-109.

**9.2 TYPES CNA-20089 AND CNA-20090
POWER UNITS**

9.21 The actual wiring diagrams of the Types CNA-20089 and CNA-20090 Power Units are shown in Dwg. No. 16.11. Inasmuch as the two Power Units are identical, except for power transformers, the following material will be applicable to either.

9.22 A.C. power input is supplied through plug P-201, cable W-201 and plug P-202 to connector J-201 of the Power Unit. The primary circuit of the power transformer T-201 is fused with two one-ampere fuses F-201 and F-202, one fuse being connected in each side of the circuit. These fuses provide adequate protection to the power transformer T-201 and the rectifier tube V-201 in the event of failure of any component in the equipment which might impose a heavy overload upon the Power Unit.

9.23 Radio frequency signals or disturbances which might be picked up by the power source wiring or by cable W-201 are prevented from reaching the Radio Receiver by means of filter capacitors C-201 and C-202. The power transformer T-201 is built with an electrostatic shield between the primary and secondary windings to further attenuate such undesired voltages. Capacitor C-201 is connected between one side of the primary and the chassis of the power unit. In the event that the power supply lines have one side grounded, a small A.C. current may flow through capacitor C-201 producing a visible spark when the Power Unit or the RAS Equipment, as a whole, is connected to ground. The current through capacitor C-201 will not exceed .5 milliamperes, so that there is no possibility of a dangerous shock to any of the operating personnel.

9.24 The circuit arrangement, wiring and operation of the Power Unit is conventional. It should be noted, however, that neither side of the B supply circuit is connect-

ed to the chassis. It is necessary, therefore, to provide a direct, low resistance connection between the chassis of the power unit and the chassis of the radio receiver, in order that both may be at ground potential. This connection is made by means of the shield of cable W-101 of the Radio Receiver which is connected to terminal E-201 of the power unit.

**9.3 TYPES CNA-49105 AND CNA-49106
LOUD SPEAKERS**

9.31 The actual wiring diagrams of the CNA-49105 and CNA-49106 Loud Speakers are shown in Dwg. No. 16.12. The two Loud Speakers are identical, electrically.

9.32 Connection between the speaker output terminals E-107 of the Radio Receiver and the Loud Speaker is made by shielded cable W-301. The cable shield is connected to terminal E-108 and provides a bond between the loud speaker chassis and the chassis of the Radio Receiver, thus maintaining them at ground potential.

**9.4 COIL SETS TYPES CNA-47156 TO
CNA-47162 INCLUSIVE**

9.41 While the construction and operation of all Coil Sets of the Model RAS Equipment are similar, individual components of the various Coil Sets differ considerably. These differences are required to maintain the overall characteristics of the RAS Equipment as nearly uniform as practicable over the frequency range of 190 to 30,000 kilocycles.

9.42 The actual wiring diagram of Type CNA-47156 Coil Set is shown in Dwg. No. 16.13.

9.421 Trimmer capacitors C-401, C-402, C-403 and C-404 are used to adjust the minimum capacities of the tuned circuits to which they are connected, serving to compensate for unavoidable variations in wiring and tube capacities.

9.422 R.F. transformer assembly T-401 has a low inductance primary winding loosely coupled to a tuned secondary to provide the proper input impedance for conventional antenna systems operating in the frequency range of the Coil Set.

9.423 The second R.F. amplifier transformer assembly T-402 is built to provide maximum amplification at the low frequency end of the Coil Set tuning range. This is accomplished by so proportioning primary L-402 that the primary circuit, as a whole, resonates broadly at a frequency outside the low frequency limit of the Coil Set tuning range. The primary circuit will, therefore, show increasing impedance as the receiver

is tuned to signals of lower frequency. The impedance of the R.F. tuned circuit decreases as the L/C ratio decreases, thus tending to reduce stage gain as the low frequency end of the tuning range is approached. The resonant characteristic of the primary described above increases gain at low frequencies, over-compensating for the lowering impedance of the secondary. In order to obtain the proper amount of compensation, a small coupling capacity is provided between terminals 1 and 5 of the transformer. This capacity is in the order of 1 or 2 mmf. and is obtained by utilizing the capacity between coil leads, stray wiring capacity, etc.

9.424 The first detector transformer assembly T-403 has a low inductance primary and, in consequence, stage gain is maximum at the high frequency end of the coil set tuning range. The use of a high inductance resonant primary is undesirable in this portion of the circuit since it tends to cause feedback in the I.F. amplifier. Its use is not required as the second R.F. amplifier transformer furnishes adequate gain compensation.

9.425 The operating principles of the H.F. oscillator were discussed under Par. 9.13. It will be noted that capacitors C-405 and C-406 are connected in parallel. Actually, capacitor C-405 is used as a vernier adjustment for capacitor C-406 since the net capacity of the two is critical and must be adjusted with a high degree of precision.

9.43 The actual wiring diagram of the Type CNA-47157 Coil Set is shown in Dwg. No. 16.14. The operating principles of all circuit components are similar to those of the Type CNA-47156 Coil Set, described under Par. 9.42.

9.44 The actual wiring diagram of the Type CNA-47158 Coil Set is shown in Dwg. No. 16.15. The operating principles of all circuit components are similar to those of the Type CNA-47156 Coil Set, described under Par. 9.42.

9.45 The actual wiring diagram of the Type CNA-47159 Coil Set is shown in Dwg. No. 16.16. The operating principles of all circuit components are similar to those of the Type CNA-47156 Coil Set, as described under Par. 9.42, with the exception of the first detector transformer T-703 which uses a high inductance primary L-704. Gain compensation in R.F. transformer assemblies T-702 and T-703 is arranged to produce essentially uniform amplification in each over the tuning range of the coil set. A single series padding capacitor C-705 is used in the H.F. oscillator transformer assembly

T-704, no vernier adjustment being required.

9.46 The actual wiring diagram of the Type CNA-47160 Coil Set is shown in Dwg. No. 16.17. The operating principles of all circuit components are similar to those of the Type CNA-47159 Coil Set, as described under Par. 9.45.

9.47 The actual wiring diagram of Type CNA-47161 Coil Set is shown in Dwg. No. 16.18. The operating principles of all circuit components are similar to those of the Type CNA-47156 Coil Set, described under Par. 9.42. A single series padding capacitor C-905 is used in the H.F. oscillator transformer assembly T-904, no vernier adjustment being required.

9.48 The actual wiring diagram of the Type CNA-47162 Coil Set is shown in Dwg. No. 16.19.

9.481 Trimmer capacitors C-1001, C-1004, C-1005 and C-1006 are used to adjust minimum circuit capacity, as explained under Par. 9.421.

9.482 The first R.F. amplifier transformer T-1001 of the Type CNA-47162 Coil Set differs from those previously described in two respects:

(1) Series capacitor C-1003 is connected in the antenna primary circuit and serves to reduce the detuning effect of the antenna upon the secondary tuned circuit.

(2) A series padding capacitor C-1002 is connected between transformer terminals 1 and 2 and serves to modify the effective capacity range of the first R.F. section C-101A of the main tuning capacitor C-101. Such modification is required to provide accurate tracking of the first R.F. amplifier, second R.F. amplifier and first detector tuned circuits.

9.483 The second R.F. amplifier transformer T-1002 has three windings all closely coupled together. The primary winding connected in the plate circuit of the first R.F. tube V-101 is interwound with the tuned secondary winding and both have approximately the same number of turns. A third winding which feeds the control grid of the second R.F. amplifier tube V-102 is so proportioned that its natural period (or resonant frequency) falls just outside the low frequency end of the frequency range covered by the coil set. The impedance of this resonant secondary increases as the low frequency end of the tuning range is approached, thus tending to compensate for the unfavorable L/C ratio of the tuned secondary in much the same manner as explained under Par. 9.423. The resonant secondary arrangement is preferable to the resonant

primary, previously described, in the 14-30 megacycle range. Its use renders the tuned circuit more efficient by reducing the damping effect of high grid conductance which is characteristic of the Type -38646 tube in this frequency range.

The reactance of the resonant secondary varies considerably over the tuning range of the coil set and since it is closely coupled to the tuned circuit, the normal tuning range is altered exactly as if a padding capacitor were connected in series with the second R.F. amplifier section C-101B of the main tuning capacitor C-101. It is for this reason that capacitor C-1002 is required in the first R.F. amplifier transformer assembly T-1001, as mentioned under Par. 9.482.

9.484 The operating principles of the first detector transformer L-1002 are similar to those of the second R.F. amplifier transformer L-1002 described under Par. 9.483.

9.485 The operating principles of the H.F. oscillator transformer assembly T-1004 are similar to those described under Par. 9.425 except that the series padding capacitor C-1007 has less capacity than that which would normally be required, because of the modified tuning characteristics of the first R.F. amplifier, second R.F. amplifier and first detector transformers, as mentioned in Par. 9.482, 9.483 and 9.484.

10. OPERATING INSTRUCTIONS

10.1 CONTROLS

10.101 All switches and controls (with the exception of the main tuning dial) of the Type CNA-46080 Radio Receiver are identified by panel engraving or by etched dial scales. The A.C. supply switch of the Type CNA-20090 Power Unit (and Type CNA-20089 Power Unit) is identified by an "ON-OFF" plate.

10.102 The main tuning dial N-101 is located at the center of the front panel of the Type CNA-46080 Radio Receiver. As previously described, this dial drives the four-gang tuning capacitor C-101. The dial drive is so arranged that the frequency to which the receiver tunes increases as the dial reading increases. See Dwg. No. 11.7. Each Coil Set is fitted with a calibration chart showing the relationship between dial reading and frequency.

10.103 The R.F. GAIN control N-102 (R-115) is located at the lower right-hand corner of the receiver front panel and serves to adjust the amplification of the second R.F., first and second I.F. stages. Maximum sensitivity is obtained by rotating the control knob to the extreme clockwise position, 10. In this position all tubes are operating at maximum gain with minimum bias. As the control is turned counterclockwise, increasing bias is applied to the second R.F. tube V-102, first I.F. tube V-105 and second I.F. tube V-106, thus reducing their amplification.

10.104 Directly above the R.F. GAIN control is a two-position toggle switch S-103. In the B+ OFF position, the positive lead of the power supply circuit is opened and the receiver is inoperative. In the B+ ON position, the power supply circuits are complete.

10.105 A pilot light I-101 is illuminated when the tube heater circuits are supplied with power from the Power Unit.

10.106 The C.W. OSC. control knob N-103 (C-126, S-101), located at the lower left side of the front panel, controls the CW oscillator. In the OFF position, B power is disconnected from both plate and screen circuits of the CW oscillator tube V-108. Rotating the knob in a clockwise direction throws a switch S-101 that connects B voltage to the plate and screen circuits. Further rotation of the knob from 0 on the scale to 10 varies the frequency of the CW oscillator over a range of approximately 10 kc. by means of capacitor C-126. The CW oscillator tunes to the intermediate frequency, 175 kc., at 9 on the scale.

10.107 Above the C.W. OSC. knob is the A.V.C. switch S-102. In the OFF position the automatic volume control is inoperative while in the ON position, the automatic volume control circuit functions normally.

10.108 At the left hand side of the panel, above the A.V.C. switch, is the A.F. GAIN control knob N-104. This knob is attached to potentiometer R-136 in the grid circuit of the output amplifier tube V-109 and is used to adjust the audio signal voltage applied to the control grid.

10.109 A terminal panel E-106, marked "BSW", is mounted at the rear of the receiver chassis. Two terminals are provided which are connected in parallel with the B+ switch S-103. These terminals provide a convenient means for remote control of the equipment by employing a suitable relay or switch.

10.110 The Types CNA-20089 and CNA-20090 Power Units are each fitted with a toggle switch S-201 for controlling the primary A.C. power circuit.

10.2 MCW RECEPTION

10.21 After the Model RAS Equipment is properly installed as specified in Section 6, Installation, it is put into operation by turning the Power Unit switch S-201 ON and the Receiver B+ switch S-103 ON. The C.W. OSC. control must be turned OFF. The A.V.C. switch S-102 may be in either the ON or OFF position. The Equipment is now adjusted for MCW reception and will tune in accordance with the frequency calibration of the Coil Set in use.

10.22 With A.V.C. OFF, the setting of the A.F. GAIN and R.F. GAIN controls will depend to some extent upon operating conditions. It is recommended that the A.F. GAIN control be set at about 5 and the R.F. GAIN control advanced as may be required to provide a satisfactory audio signal. When receiving weak signals, best signal-to-noise ratio will be obtained by retarding the A.F. GAIN control and advancing the R.F. GAIN control to a point as near maximum as receiving conditions permit. The operator must be careful to avoid overloading the I.F. or second detector stages under these conditions. Overload will be indicated by excessive audio distortion.

10.23 To receive MCW signals with automatic volume control, the A.V.C. switch must be in the ON position. The R.F. GAIN control should be advanced to a point as near maximum as receiving conditions permit. Audio output should be controlled entirely by means of the A.F. GAIN control. When the noise level is so high that it is found impractical to fully advance the R.F. GAIN control, the control may be retarded to limit the overall sensitivity of the receiver to a definite maximum. The operator must remember, however, that the full range of A.V.C. action cannot be obtained unless the R.F. GAIN control is fully advanced.

10.3 CW RECEPTION

10.31 The initial adjustment of the RAS Equipment for CW reception is as described in Par. 10.21, except that the A.V.C. switch must be OFF. The C.W. OSC. control should be set at 9 on the scale.

10.32 Although the settings of the R.F. GAIN and A.F. GAIN controls will depend to some extent upon operating conditions, it is recommended that the A.F. GAIN control be set at about 5 and the R.F. GAIN control advanced as may be required to provide a satisfactory audio signal. Advancing the R.F. GAIN control too much may cause I.F. or second detector overload. Such overload is indicated by a change in pitch of the CW beat note over the duration of a code character, or by excessive "thumping".

10.33 The best setting of the C.W. OSC. control will also depend upon operating conditions. When the received signal is free from interference and is sufficiently strong to override static and circuit noise, it is recommended that the C.W. OSC. control be set at the position which tunes the C.W. oscillator to the intermediate frequency of the receiver. This setting will normally be between 8 and 10. As the control is turned counterclockwise, the C.W. oscillator is detuned from the intermediate frequency of the receiver. The operator can determine the extent of this deviation by listening to the characteristic pitch of background and circuit noises. When this pitch is 2000 or 3000 cycles, it will be found that the Receiver has definite "single signal" properties such that one side of the audio beat note of a received signal will be considerably louder than the other side. This characteristic is helpful in receiving weak signals through interference and utilizes the maximum available sensitivity and selectivity of the receiver.

10.34 If the A.V.C. switch is turned ON, with the CW oscillator in operation, the Receiver will block and become extremely insensitive.

11. PERFORMANCE DATA

The SENSITIVITY vs. FREQUENCY curves of Dwg. No. 11.1 indicate the overall sensitivity of the Model RAS Radio Receiving Equipment. These curves, together with MAXIMUM NOISE LEVEL curves of Dwg. No. 11.2, provide data for definitely checking the Type CNA-46080 Radio Receiver to determine if repairs or realignment are necessary, since the majority of circuit element failures, or any misalignment, will reduce both sensitivity and maximum noise level of the Equipment. The data referred to above

will, therefore, also serve to show the efficiency of repairs or realignment.

The SELECTIVITY, IMAGE ATTENUATION, FIDELITY and A.V.C. characteristics of Dwg. Nos. 11.3 to 11.6 inclusive are necessary where a particular performance check is desired, but are of secondary importance in most cases, since an Equipment having normal SENSITIVITY and MAXIMUM NOISE characteristics will, in all probability, be normal in all other respects.

MODEL RAS RADIO RECEIVING EQUIPMENT

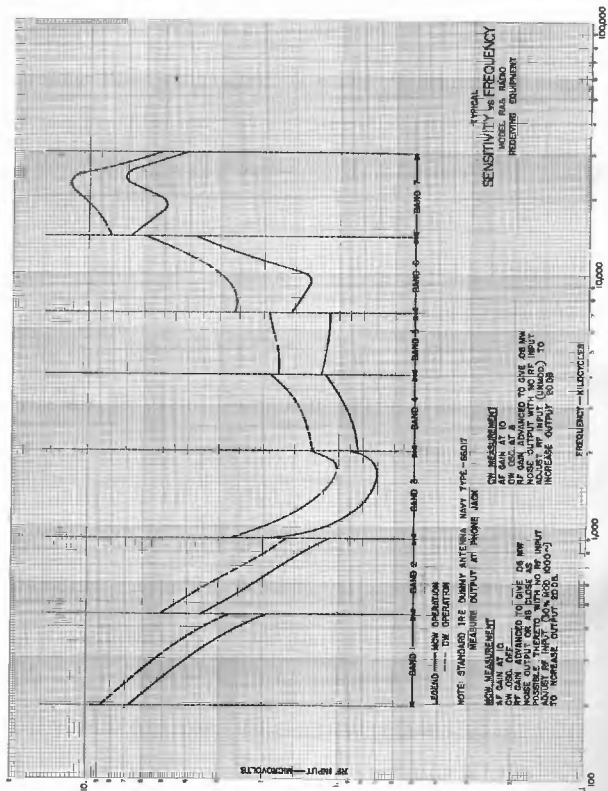

DWG. NO. III

MODEL RAS RADIO RECEIVING EQUIPMENT

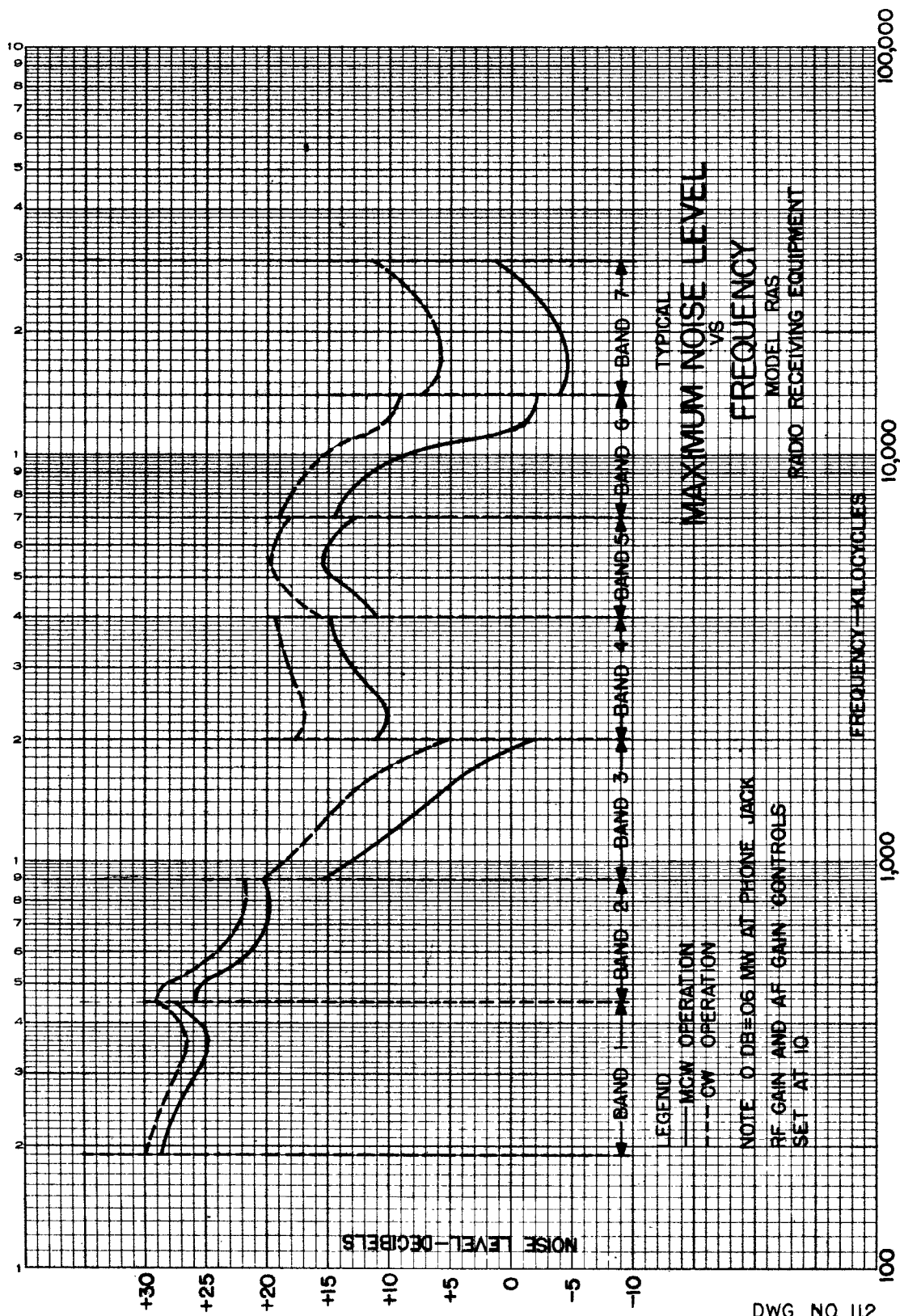

DWG. NO. 112

MODEL RAS RADIO RECEIVING EQUIPMENT

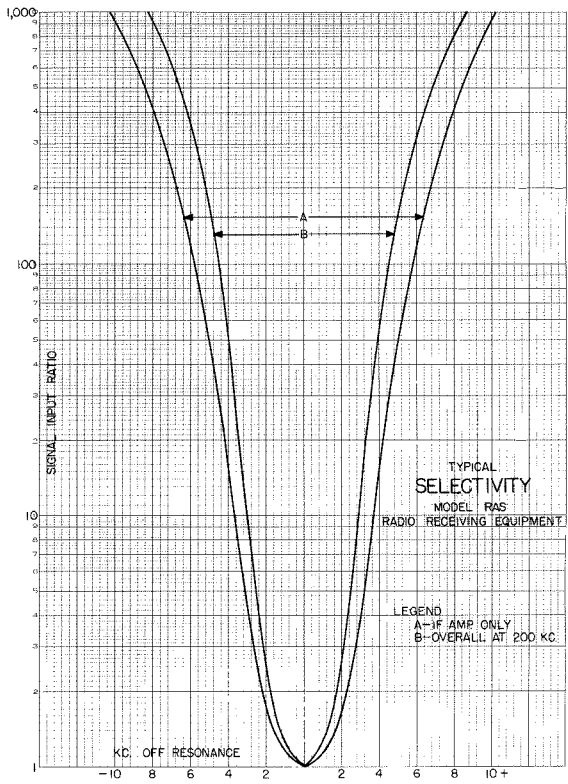

DWG NO 113

MODEL RAS RADIO RECEIVING EQUIPMENT

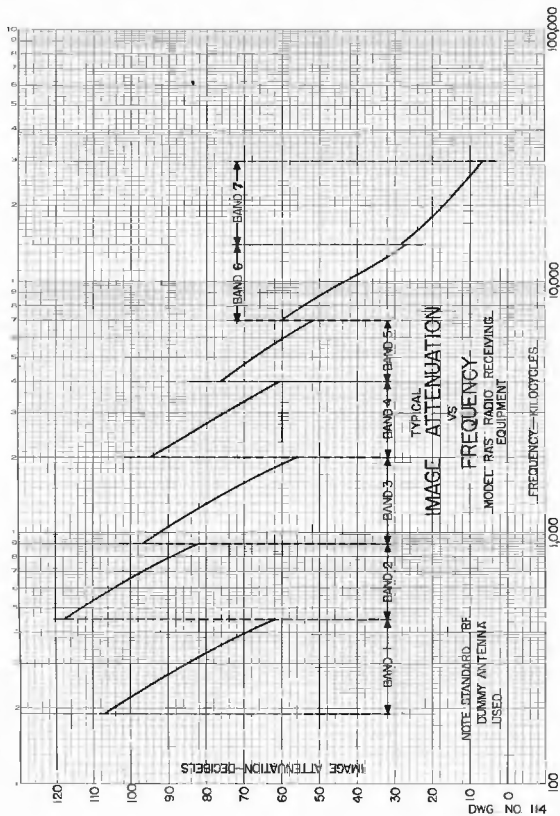

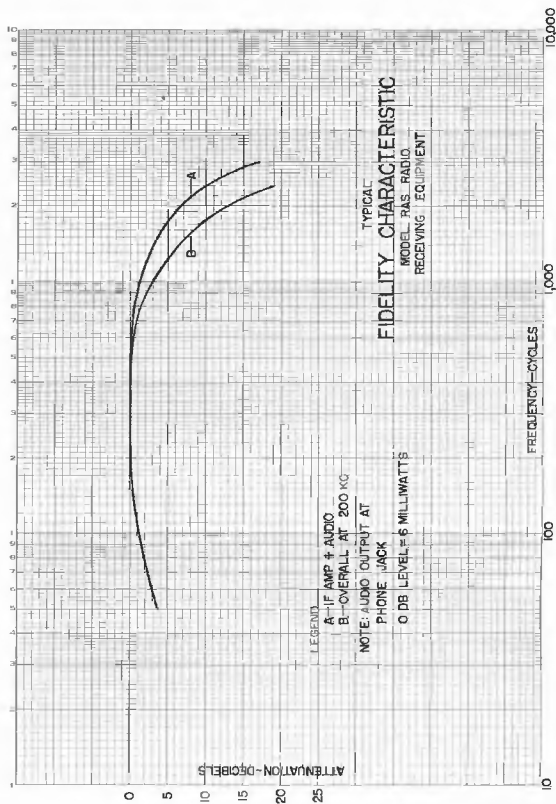

DWG. NO. 115

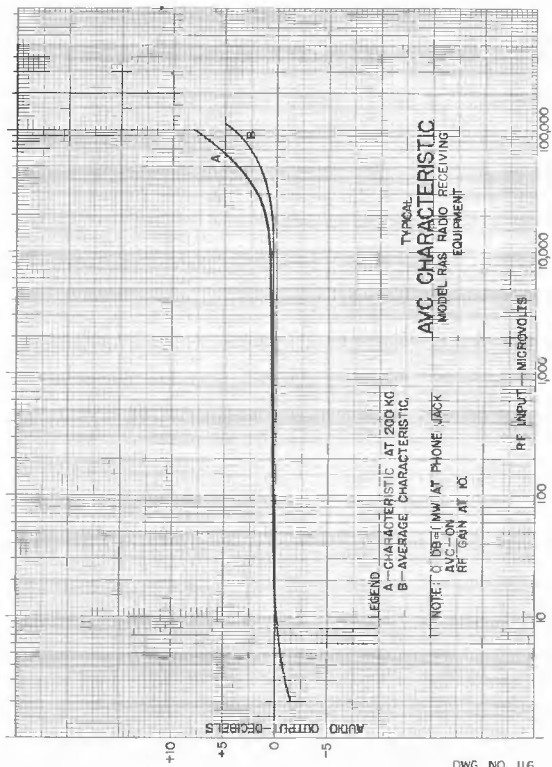

MODEL RAS RADIO RECEIVING EQUIPMENT

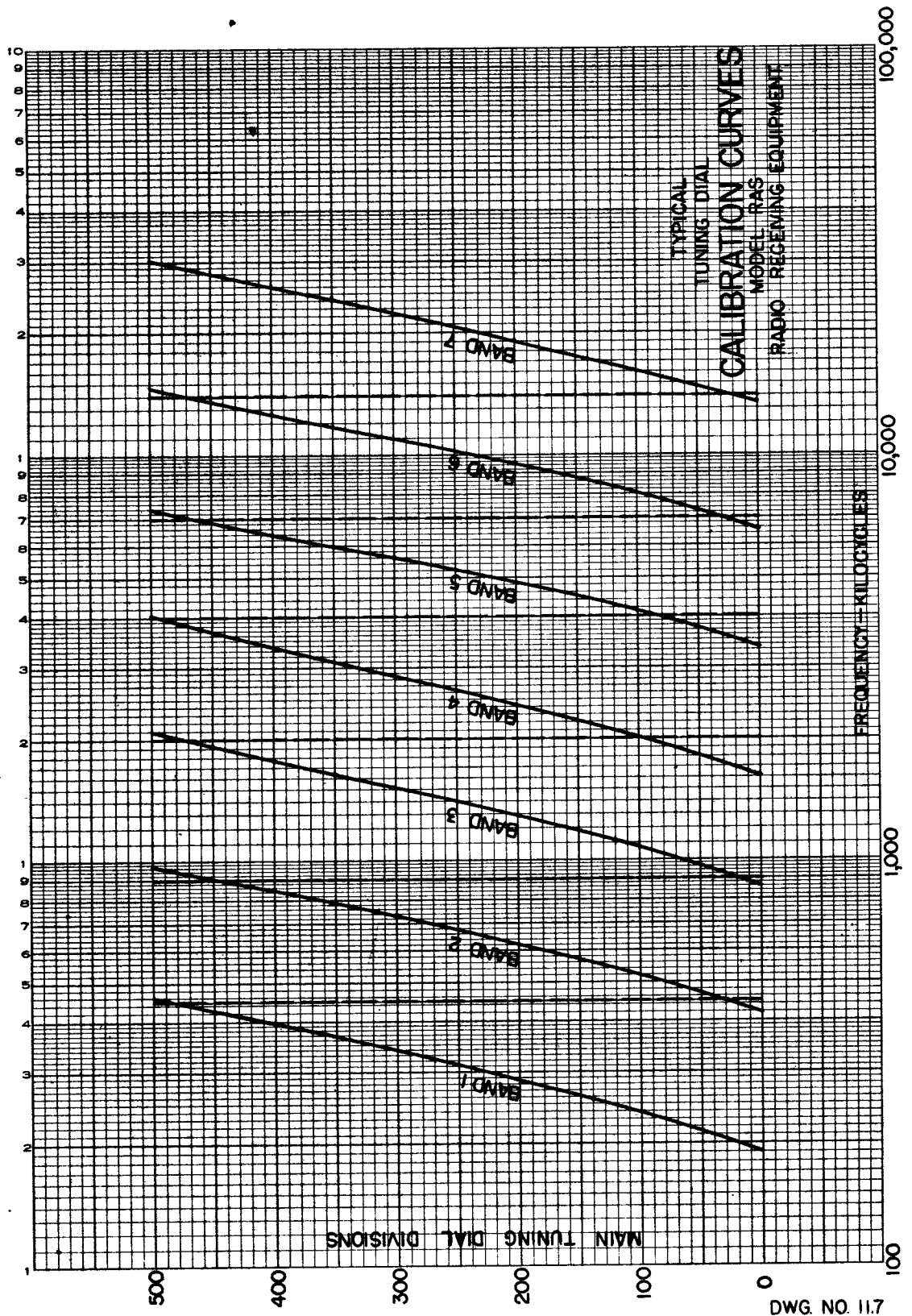

12. MAINTENANCE — FAILURES AND REMEDIES

12.1 GENERAL

12.11 Adequate test equipment for maintenance of the Model RAS Radio Receiving Equipment should include the following items:

(1) A Model LP Radio Frequency Standard Signal Generator Equipment, or equivalent.

(2) An audio output meter, General Radio Company Type 583A, or equivalent.

(3) A resistance bridge or ohmmeter capable of measuring resistance from a fraction of an ohm to about 10 megohms.

(4) An analyzer of the type designed for testing vacuum tubes and measuring the D.C. potentials and currents in the circuits with which the tube under test is associated.

The performance and test data of Sections 11 and 13 were determined with equipment as listed above.

12.12 In making any tests or adjustments, it is essential that the operator consider the influence that any one circuit element may have upon other associated circuits. The test data of Section 13 will be particularly helpful in determining the extent of such influence and the necessity for making further replacements after a fault in one particular circuit element has been located and repaired.

12.13 Any repairs in the Model RAS Equipment which necessitate resoldering of joints should be made with care. The new joint should be such that the pieces to be soldered are firmly connected mechanically before solder is applied. After soldering, the joint should be covered with moisture resistant lacquer or varnish to conform with other soldered connections throughout the equipment.

12.2 TUBE REPLACEMENTS

12.21 ALL TUBES SUPPLIED WITH THE EQUIPMENT OR AS SPARES ON THE EQUIPMENT CONTRACT SHALL BE USED IN THE EQUIPMENT PRIOR TO EMPLOYMENT OF TUBES FROM GENERAL STOCK.

12.22 All tubes in the Model RAS Equipment, except the type 6V6G° audio amplifier V-109, are standard in Naval service. Navy type designations are listed in Sections 3 and 7.

°6V6GT may be substituted.

12.23 Failure of a vacuum tube in the Receiver may reduce the sensitivity of

the equipment to radio signals, produce intermittent operation or cause the equipment to be completely inoperative. In such cases, all tubes should be checked either in an analyzer or similar tube testing equipment, or by replacement with tubes of proven quality. When any tube is tested, it should be tapped or jarred to make sure that it has no internal loose connection or intermittent short-circuit.

12.24 When tube replacements become necessary, substitution of new tubes may alter the alignment of the R.F. or I.F. circuits inasmuch as the replacement tubes may not be identical with those originally employed. The necessity for realignment as well as alignment procedure is discussed in Section 14.

12.25 A replacement high frequency oscillator tube V-104 should be checked in the Receiver as follows: apply a 25 to 30 megacycle unmodulated test signal of at least 10 microvolts at the antenna input terminals E-101. Tune in the signal with the receiver adjusted for MCW reception (see Par. 10.23), with the A.V.C. switch ON. Tap the replacement tube V-104 with a piece of insulating material or jar the receiver as a whole: this should not produce persistent microphonic noise in the loud speaker. Turn the A.V.C. switch OFF and turn the C.W. OSC. control to 9; retard the R.F. GAIN control as necessary to avoid overload and adjust the receiver to give an audible beat note. A poor replacement tube V-104 may cause "modulation hum" or 60 cycle modulation of the beat note. A good tube will not cause such modulation. The tube should be tapped to make sure that its characteristics will not change if the Receiver is subjected to vibration.

12.3 FAILURE OF THE RADIO RECEIVER

12.31 In case of breakdown or failure of the Type CNA-46080 Radio Receiver, the fault must first be localized in one portion of the circuit. This can be accomplished by observation of some peculiar action of one of the controls or by checking the Receiver against the test data tabulated in Section 13. Reference to Dwg. No. 16.10 and Dwgs. 16.13 to 16.19 inclusive, and Photos Nos. 17.01, 17.02 and 17.09 to 17.18 inclusive will show the location of any component part of the receiver. Functions and ratings of component parts are given in the Parts Lists, Section 15.

12.32 It must be remembered that the test data of Section 13 will not positively

locate certain faults. For instance, an open-circuited by-pass capacitor will not appear in point to point resistance tests and may introduce regeneration or oscillation in certain circuits which affect the stage gain of other circuits. Similarly, a short-circuit occurring in a low resistance inductor will not appear in point to point resistance tests and if the short appears in an R.F. coil, a false indication of the necessity for realignment may result.

12.33 By-pass or filter capacitors which develop poor connections internally or which become open-circuited will cause decreased sensitivity and/or poor stability. The defective unit can be located by temporarily connecting a good capacitor in parallel with each capacitor that is under suspicion.

12.34 Failure of any by-pass or filter capacitor may seriously overload resistors of the associated circuits. Overloads of sufficient magnitude to permanently damage a resistor will cause the painted surface of the resistor to be scorched, making the defective unit easy to locate by visual inspection.

12.35 Open- or short-circuited resistors can be definitely located by testing the resistance of each individual resistor. The wiring diagram, Dwg. No. 16.10, should be consulted to make sure that any particular resistor under test is not connected in parallel with some other circuit element which might produce false measurement.

12.36 Loose connections which cause intermittent or noisy operation which cannot be found by point to point resistance tests, or by other test data of Section 13, can be located by individually testing each circuit element or by tapping or shaking any component under suspicion, with the Receiver adjusted for normal operation.

12.4 FAILURE OF THE POWER UNIT

12.41 In case of failure of the Type CNA-20089 or CNA-20090 Power Unit, the voltage chart of Section 13 will provide the best means for locating the fault. Individual components should be checked to make sure that they have the characteristics listed under "Description" of Section 15, Table 1, Section 2.

12.42 One or both primary fuses F-201, F-202, will blow out, opening the primary circuit of transformer T-201, when a failure occurs in the power transformer or rectifier circuit which produces a sustained primary current in excess of approximately 1.5 amperes. Failure of one or both filter

capacitors C-203 and C-204 will blow out one or both fuses. Failure of capacitor C-205 or capacitor C-206 or a failure in the B supply circuits of the Type CNA-46080 Radio Receiver will not produce sufficient overload to harm any component of the Power Unit and the fuses will not blow out when such failures occur.

12.43 The rectifier tube V-201 and the fuses F-201, F-202 are made accessible by removing the metal grille which is attached to the Power Unit panel by four knurled thumb screws.

12.5 FAILURE OF LOUD SPEAKER

12.51 In case of failure of the Type CNA-49105 or CNA-49106 Loud Speaker, the primary and secondary of transformer T-301 and the voice coil of loud speaker LS-301 should be checked for open- or short-circuits. Transformer T-301 may also be checked by disconnecting the voice coil and connecting secondary terminals 3 and 4 directly to an output meter, the impedance of which must, in this case, be approximately 2.8 ohms. A normal transformer T-301 will show a power loss of 1 db. at 400 cycles.

12.52 Rattles or scratching noises which may accompany a signal can be caused by improper centering of the voice coil of Loud Speaker LS-301 or by small particles of foreign matter in the air gap between the voice coil and permanent magnet field. The air gap may be cleaned by removing Loud Speaker LS-301 from its cabinet and brushing or wiping the inside of the annular gap with a narrow strip of paper. In reassembling the Loud Speaker, care must be taken to avoid distorting the cone mounting frame when the speaker mounting nuts are tightened.

12.53 In some installations where the equipment is subjected to considerable vibration, or where vacuum tubes show microphonic tendencies, it is often possible to eliminate sustained microphonic audio oscillation by reversing the loud speaker leads. Such procedure is not ordinarily required and is recommended only in cases of emergency where replacement tubes free from microphonism, are not available.

13. TEST DATA

The TUBE SOCKET VOLTAGES AND CATHODE CURRENTS Table 13.1 must not be considered as a list of the actual operating circuits of the Type CNA-46080 Radio Receiver. The resistance of the measuring instruments, together with capacitive and

MODEL RAS RADIO RECEIVING EQUIPMENT

resistive loading effects, will disturb many of the circuits to such an extent that they become inoperative, thus altering normal voltage and current distribution.

The only currents listed in Table 13.1 are those in the various cathode circuits. This listing is a desirable simplification, inasmuch as measurement of cathode current constitutes a definite check on all circuits directly associated with the vacuum tube in question.

The POINT TO POINT RESISTANCE Table 13.2 shows average resistance values in the Type CNA-46080 Radio Receiver with the Type CNA-49105 or CNA-49106 Loud Speaker disconnected from terminals E-107, and cable plug P-101 disconnected from the Power Unit socket J-202. The vacuum tubes need not be removed from their sockets. In using Table 13.2, the statements of Par. 12.32 must be given careful consideration.

13.1 TUBE SOCKET VOLTAGES AND CATHODE CURRENTS							
<i>Terminal</i>	<i>Variable</i>		<i>Voltage D.C. Volts</i>		<i>Current D.C. MA.</i>		
	<i>Symbol</i>	<i>Setting</i>	<i>R-115 At 0</i>	<i>R-115 At 10</i>	<i>R-115 At 0</i>	<i>R-115 At 10</i>	
V-101	Grid	None	0	0			
V-101	Cathode	None	A 3	A 2	8.	6.	
V-101	Screen	None	B 100	B 56			
V-101	Plate	None	B 190	B 170			
V-102	Grid	None	0	0			
V-102	Cathode	None	A 28	A 2	.4	6.	
V-102	Screen	None	B 100	B 56			
V-102	Plate	None	B 190	B 170			
V-103	Grid	None	0	0			
V-103	Cathode	See #	A 4	A 3.5	.8	.7	
V-103	Screen	See #	B 70	B 64			
V-103	Plate	None	B 190	B 170			
V-104	Grid	See #	—*	—*			
V-104	Cathode	See #	0	0	—*	—*	
V-104	Screen	See #	B 110*	B 100*			
V-104	Plate	See #	B 190*	B 170*			
V-105	Grid	None	0	0			
V-105	Cathode	None	A 29	A 2	.4	6.	
V-105	Screen	None	B 112	B 68			
V-105	Plate	None	B 182	B 150			
V-106	Grid	None	0	0			
V-106	Cathode	None	A 32	A 5.5	.4	1.5	
V-106	Screen	None	B 110	B 68			
V-106	Plate	None	B 180	B 150			
V-107A	Grid	None	0	0			
V-107A	Cathode	S-101	OFF	A 7.5	A 7.5	.4	.4
V-107A	Cathode	S-101	ON	A 12.5	A 12.	.6	.6
V-107A	Plate	S-101	OFF	B 125	B 110		
V-107A	Plate	S-101	ON	B 105	B 93		
V-107B	Grid	See °	0	0			
V-107B	Cathode	See °	A 6	A 7.5	0	0	
V-107B	Plate	None	0	0			
V-108	Grid	S-101	See *	See *			
V-108	Cathode	S-101	OFF	0	0	0	0
V-108	Cathode	S-101	ON	0	0	See *	See *
V-108	Screen	S-101	OFF	0	0		
V-108	Screen	S-101	ON	B 14 *	B 12 *		
V-108	Plate	S-101	OFF	0	0		
V-108	Plate	S-101	ON	B 33 *	B 30 *		
V-109	Grid	See °	0	0			
V-109	Cathode	See °	A 11.5	A 11.	46.	44.	
V-109	Screen	See °	B 250	B 245			

(Continued on next page)

13.1 TUBE SOCKET VOLTAGES AND CATHODE CURRENTS (Continued)						
Terminal	Variable		Voltage D.C. Volts		Current D.A. MA.	
	Symbol	Setting	R-115 At 0	R-115 At 0	R-115 At 10	R-115 At 10
V-109 Plate Chassis	See ° See °		B 240 B 58	B 230 B 70		

All measurements made with equipment connected for normal operation. Power input 115 volts, 25 or 60 cycles. A.V.C. switch S-102 turned OFF and C.W. OSC. control turned OFF unless otherwise specified.

Voltage measurements made with a D.C. voltmeter, 1000 ohms per volt. "A" readings taken on 0-50 volt scale, i.e., meter resistance is 50,000 ohms. "B" readings taken on 0-250 volt scale, i.e., meter resistance is 250,000 ohms. Unless otherwise specified, voltage is measured between terminal and receiver chassis.

All readings will depend (in varying degree) upon the resistance of the meter. Readings not marked with an asterisk are subject to a variation of plus or minus 15%.

Voltages and currents in this circuit are influenced by the setting of the tuning capacitor C-101, and by the radio frequency band in use. Measurement (if any) taken at 2000 kilocycles using Type CNA-47159 Coil Set (No. 4).

* Accurate measurement of voltage and/or current in this circuit cannot be made with an "analyzer" due to loading effects.

° This voltage measurement is made between terminal and B minus. Negative terminal of voltmeter to B minus.

13.2 POINT TO POINT RESISTANCES (Terminal to Chassis)				
Terminal	Variable		Resistance (Ohms) Plus or Minus 15%	
	Symbol	Setting		
V-101 Grid	S-102	ON	1,100,000	
V-101 Grid	S-102	OFF	500,000	
V-101 Cathode	None		300	
V-101 Screen	R-115	0	37,000	
V-101 Screen	R-115	10	32,000	
V-101 Plate	R-115	0	39,000	
V-101 Plate	R-115	10	34,000	
V-102 Grid	S-102	ON	1,100,000	
V-102 Grid	S-102	OFF	500,000	
V-102 Cathode	R-115	0	9,800	
V-102 Cathode	R-115	10	300	
V-102 Screen	R-115	0	37,000	
V-102 Screen	R-115	10	32,000	
V-102 Plate	R-115	0	39,000	
V-102 Plate	R-115	10	34,000	
V-103 Grid	None		See #	
V-103 Cathode	None		5,000	
V-103 Screen	R-115	0	145,000	
V-103 Screen	R-115	10	142,000	
V-103 Plate	R-115	0	41,000	
V-103 Plate	R-115	10	36,000	
V-104 Grid	None		20,000	

MODEL RAS RADIO RECEIVING EQUIPMENT

13.2 POINT TO POINT RESISTANCES (Continued)
(Terminal to Chassis)

Terminal	Variable		Resistance (Ohms) Plus or Minus 15%
	Symbol	Setting	
V-104 Cathode	None		See #
V-104 Screen	R-115	0	45,000
V-104 Screen	R-115	10	42,000
V-104 Plate	R-115	0	41,000
V-104 Plate	R-115	10	36,000
V-105 Grid	S-102	ON	1,100,000
V-105 Grid	S-102	OFF	500,000
V-105 Cathode	R-115	0	9,800
V-105 Cathode	R-115	10	300
V-105 Screen	R-115	0	32,000
V-105 Screen	R-115	10	27,000
V-105 Plate	R-115	0	41,000
V-105 Plate	R-115	10	36,000
V-106 Grid	S-102	ON	1,100,000
V-106 Grid	S-102	OFF	500,000
V-106 Cathode	R-115	0	10,800
V-106 Cathode	R-115	10	1,500
V-106 Screen	R-115	0	32,000
V-106 Screen	R-115	10	27,000
V-106 Plate	R-115	0	41,000
V-106 Plate	R-115	10	36,000
V-107A Grid	None		47.5
V-107A Cathode	None		20,000
V-107A Plate	R-115	0	120,000
V-107A Plate	R-115	10	115,000
V-107B Grid	None		500,000
V-107B Cathode	None		2,000
V-107B Plate	S-102	ON	100,000
V-107B Plate	S-102	OFF	83,000
V-108 Grid	None		50,000
V-108 Cathode	None		6.
V-108 Screen	S-101	ON	80,000
V-108 Screen	S-101	OFF	100,000
V-108 Plate	S-101	ON	120,000
V-108 Plate	S-101	OFF	200,000
V-109 Grid	R-136	0	2,250
V-109 Grid	R-136	10	500,000
V-109 Cathode	None		2,500
V-109 Screen	R-115	0	39,000
V-109 Screen	R-115	10	34,000
V-109 Plate	None		Inf.
B Minus	None		2,250

Refer to "Parts List by Symbol Designations"
Sub-sections 4 to 10 inclusive.

80M1 | KC = 27 m 40° | KC = 95°

MODEL RAS RADIO RECEIVING EQUIPMENT

13.3 STAGE GAIN MEASUREMENTS

The sensitivity measurements listed below are made under the following conditions. The Model RAS Equipment is set up in accordance with Par. 14.14 with Coil Set No. 4 in operation. The Standard Signal Generator is connected in accordance with Par. 14.23 except that the high output lead is connected to the grid of the tube specified in the list below, and the test signal is $175 \pm .5$ Kc. modulated 30% 400 cycles. Both R.F. GAIN and A.F. GAIN controls of the receiver must be fully advanced, the A.V.C. switch must be OFF, and the C.W. OSC. control must be OFF.

With 6 milliwatt output at the phone jack, the test signal should be within the limits specified below. The same data will apply with 500 milliwatt output at the speaker terminals E-107, the output meter being connected in place of the Loud Speaker.

Terminal	Test Signal
V-103 Grid	34 ± 10 Microvolts
V-105 Grid	1000 ± 200 Microvolts
V-106 Grid	40000 ± 8000 Microvolts
V-107A Grid	Over 1. Volt

14. ALIGNMENT DATA

14.1 GENERAL

14.11 Should realignment of the Type CNA-46080 Radio Receiver become necessary, the following alignment data should be carefully studied before making any circuit adjustments. It is important that the operator understand the function of each circuit element so that correct alignment may be obtained quickly and accurately. The alignment data of this section is, therefore, supplemented by Section 8, Construction, and Section 9, Circuit Description.

CNA-46080 Radio Receiver, the Receiver must be taken out of the Mounting Rack and the dust cover removed. The power supply cable plug P-101 must be inserted in socket E-201 of the Type CNA-20089 or CNA-20090 Power Unit and the shield of cable W-101 grounded to the power unit chassis, as explained under Par. 6.4. An output meter having a 600 ohm resistive load should be connected to the phone output jack J-101. In this case, the speaker remains connected to terminals E-107. The R.F. GAIN control should be fully advanced, C.W. OSC. control turned OFF and the A.V.C. switch turned OFF. The B+ switch should be turned ON. One of the Coil Sets should be plugged into the Receiver, even though the operator plans to align and check only the I.F. or audio circuits. The frequency range of the coil set is in such cases specified in the data of Sections 11 and 13.

14.12 Performance data and test data presented in Sections 11 and 13 will be particularly helpful in determining the necessity for making any specific adjustment. The operator is cautioned against making any adjustments indiscriminately and he should not realign any circuit unless tests definitely indicate that realignment is necessary.

14.15 The complete alignment of the Radio Receiver may be divided into four steps:

14.13 All alignment and calibration tests, measurements, etc., may be made with the Model LP Standard Signal Generator, or similar equipment, and an output meter, General Radio Type 583A, or equivalent. In checking possible calibration errors, it should be remembered that the calibration accuracy of the Type CNA-46080 Radio Receiver is of the same order as that of the Model LP Standard Signal Generator. All tests are made with the Signal Generator adjusted to provide a test signal having 1000 cycle 30% modulation, unless otherwise specified.

- (1) Intermediate frequency amplifier alignment.
- (2) High frequency oscillator alignment.
- (3) Radio frequency amplifier alignment.
- (4) Tracking of H.F. oscillator and R.F. amplifier circuits.

The circuits *must* be checked in the above order when complete alignment is necessary.

14.14 Before proceeding with the alignment of any circuit of the Type

14.2 I.F. AMPLIFIER ALIGNMENT

14.21 The intermediate frequency of the Type CNA-46080 Radio Receiver is 175 kilocycles, plus or minus 1 kilocycle.

1000 = 450° KC	7300 = 487° KC	7100 = 462° KC	7200 = 474° KC	7150 = 468° KC
-------------------	-------------------	-------------------	-------------------	-------------------

MODEL RAS RADIO RECEIVING EQUIPMENT

14.22 Tuning adjustments are provided on each I.F. transformer. These adjustments are designated by symbol numbers C-115, C-116, C-121, C-122, C-131 and C-132, as indicated on Photo No. 17.18.

14.23 The high output lead of the Model LP Standard Signal Generator should be connected to the grid terminal of the first detector tube V-103 and the ground lead to any metal part making direct connection to the chassis. The flexible grid lead must be disconnected from tube V-103. Connection should be made directly from the output jack of the Standard Signal Generator, the dummy antenna being omitted. Certain types of Signal Generators other than the Model LP may not have a complete D.C. path between the two output leads; in such cases, a resistor having a value between 5,000 and 50,000 ohms should be connected between the grid of the tube V-103 and chassis, to provide a grid return path.

14.24 The frequency of the Signal Generator should be carefully adjusted to 175 kilocycles and the signal input to tube V-103 adjusted to provide a reading on the output meter, with the A.F. GAIN control of the receiver fully advanced. The I.F. tuning adjustments listed in Par. 14.22 should each be carefully adjusted to give a maximum reading on the output meter. The order in which the adjustments are made is unimportant. While making these adjustments, it may be necessary to reduce the signal input to the receiver in order to avoid overload in the second detector or audio circuits. Such overload will make the various I.F. trimmer adjustments appear to be considerably less critical than they actually are and may, in extreme cases, indicate incorrect peak adjustments. To be safe, audio output should not exceed 50% of the values specified in Par. 2.12.

14.25 The performance of the I.F. amplifier and audio circuits can be checked against the stage gain data in Section 13, Par. 13.3, after alignment has been completed. Similarly, the selectivity may be checked against the data in Section 11, Dwg. No. 11.3.

14.26 After alignment of the I.F. amplifier has been checked and found to be correct, the CW oscillator should be turned on, the C.W. OSC. control knob being set at 9. Either of capacitors C-144 or C-145, as shown in Photo No. 17.18, should be adjusted so that the frequency of the CW oscil-

lator zero beats with the 175 kilocycle test signal of the Standard Signal Generator. A modulated test signal is not necessary when making this adjustment.

14.3 HIGH FREQUENCY OSCILLATOR ALIGNMENT

14.31 The need for realignment of the high frequency oscillator section of any of the coil sets is indicated if the frequency calibration of the coil set is found to be in error by more than five divisions (plus or minus) at dial settings between 480 and 490. See Par. 14.13. If there is doubt concerning the necessity for high frequency oscillator realignment, this portion of the circuit should not be adjusted as any misalignment can be corrected by R.F. amplifier trimmer adjustments. See Sub-Section 14.4.

14.32 To check the operation of the R.F. amplifier and high frequency oscillator circuits, the Receiver is set up as described under Par. 14.14, except that the Coil Set under test must be plugged into the Receiver. The Model LP Standard Signal Generator or equivalent should be connected to the antenna input terminals through a standard dummy antenna, such as the Type CAG-66017, or as specified in the data of Sections 11 and 13. The R.F. GAIN control may be retarded somewhat if desired, as background noise may be excessive when the control is fully advanced.

14.33 Error in frequency calibration is corrected by adjustment of the high frequency oscillator trimmer capacitor indicated as Number 5 in Photo No. 17.18. A screwdriver having a metal shaft may be used but the shaft should not touch any part of the receiver chassis while making the adjustment. If the Receiver tunes to a certain frequency (near the high frequency end of the coil set range) with a numerical dial reading lower than that indicated by the calibration chart, correction is made by turning trimmer Number 5 in a clockwise direction to increase its capacity; conversely, high dial readings are corrected by turning trimmer Number 5 counterclockwise.

14.34 When aligning certain of the Coil sets, notably, Types CNA-47161 and CNA-47162, at 14.4 and 30.0 megacycles respectively, it will be found that adjustment of the first detector trimmer Number 3, as shown in Photo No. 17.18, will change the calibration of the high frequency oscillator circuit. See Par. 14.42.

R.F. Alignment

14.35 It is particularly important that the high frequency oscillator circuits operate at a higher frequency than that of the R.F. amplifier circuits. This can be checked by tuning in the image of the test signal, which is normally 350 kilocycles lower on the dial. When checking the Type CNA-47162 Coil Set near the high frequency limit of its range, the image should appear at a dial reading approximately twelve divisions lower than that of the real signal. When checking the Type CNA-47161 Coil Set, the image will appear approximately twenty-five divisions lower. The image signal should be considerably weaker (see Dwg. No. 11.4) if the R.F. amplifier is correctly aligned and a stronger test signal may be required before the image can be found. If the image signal appears at a higher dial setting rather than a lower setting, as described above, the H.F. oscillator circuit is incorrectly adjusted and the capacity of trimmer Number 5 must be decreased until the real signal and image signal appear at the proper points on the dial.

14.4 R.F. AMPLIFIER ALIGNMENT

14.41 The term "R.F. amplifier alignment", used in this Section, includes the alignment of both R.F. amplifier and first detector circuits. The set-up for checking or aligning the R.F. amplifier of the Type CNA-46080 Radio Receiver is the same as that described under Par. 14.32.

14.42 With the test signal from the Standard Signal Generator adjusted to provide a modulated signal near the high frequency limit of the coil set tuning range, tune the Receiver to give maximum output, as indicated by the output meter. R.F. trimmers Numbers 3, 2 and 1, as shown on Photo No. 17.18, may now be adjusted to give maximum output meter reading. On certain of the Coil Sets, notably, Types CNA-47161 and CNA-47162, interaction between the R.F. trimmers and the high frequency oscillator circuit will necessitate retuning the Receiver to the test signal or "rocking" the tuning dial back and forth across the test signal. If the R.F. trimmers should require considerable realignment, it may be necessary to readjust high frequency oscillator trimmer Number 5 as described in Par. 14.33 in order to maintain correct calibration. Should such readjustment of trimmer Number 5 be required, the setting of trimmers Numbers 3, 2 and 1 should be re-checked.

14.43 A very simple and quick method of R.F. trimmer alignment may be used

if a Standard Signal Generator is not available. This method consists of setting trimmers Numbers 3, 2 and 1 at the adjustment which produces maximum circuit or background noise. It will be found that trimmer settings obtained by using this method are sufficiently accurate to provide good alignment, although the adjustment must be made with care, particularly in the case of the Number 1 trimmer. The operator must also be careful to avoid alignment to the image frequency.

14.5 TRACKING OF H.F. OSCILLATOR AND R.F. AMPLIFIER CIRCUITS

14.51 After the H.F. oscillator and R.F. amplifier trimmers have been checked in accordance with Sub-Sections 14.3 and 14.4, near the high frequency limit of the coil set under test, the Receiver should be tuned near the low frequency limit of the coil set tuning range; the dial setting may be between 0 and 10. Tracking at this point may be checked by adjusting the Standard Signal Generator to the proper frequency and testing the setting of trimmers Numbers 3, 2 and 1 for maximum response. After such a test, trimmers Numbers 3, 2 and 1 should be realigned in accordance with Par. 14.42, since their settings are most critical at the high frequency end of the coil set tuning range. A simpler and quicker tracking check may be made by bending the outside rotor plates of each section of the main tuning capacitor C-101 in turn so that the maximum capacity of each circuit may be increased or decreased by a small amount. The rotor plates should not be bent so much that they will not return to their original positions when pressure is removed. Any change in capacity in any section of the main tuning capacitor should decrease the sensitivity of the receiver.

14.52 Errors in tracking near the low frequency limit of the coil set tuning range can be caused by defects in any of three circuit elements.

- (1) The tuning capacitor section.
- (2) The circuit inductance.
- (3) The oscillator series padding capacitor.

14.521 In order to determine if one or more sections of the main tuning capacitor C-101 are the cause of mis-tracking, it is necessary to make the check described under Par. 14.51 with two or more different plug-in Coil Sets. If the same tracking error appears regardless of the Coil Set in use, the main tuning capacitor is definitely at fault. The error may be corrected by

permanently bending the rotor or stator plates to provide the proper capacity.

14.522 If the tracking error appears only in the first R.F., second R.F. or first detector stage of one coil set, the inductance of the circuit in question is incorrect. All R.F. transformers which may require re-adjustment of inductance are fitted with inductive trimmers in the form of a wire loop or adjustable turn at the high potential end of the tuned secondary winding. Inductance is increased by moving the turn or loop to provide a more complete and compact solenoid. Inductive trimmers are indicated in Dwg. Nos. 16.13 to 16.19, inclusive, by arrows drawn through the upper end of the tuned secondary winding. If the tracking check of Par. 14.51 shows that more capacity is needed for correct alignment, the inductance of the tuned secondary in question is too low and must be increased by means of the inductive trimmer. Conversely, if the tracking check indicates the need of lower capacity, circuit inductance is too high and must be decreased. After any adjustment of inductance, the associated trimmer capacitor must be re-adjusted at the high frequency end of the coil range, as explained under Par. 14.42. Tracking should then be checked again at the low frequency end of the coil range, as explained under Par. 14.51.

14.523 Should the tracking checks of Par. 14.51 and Par. 14.521 indicate that the high frequency oscillator circuit of a particular coil set is at fault, either the inductance of the high frequency oscillator circuit or the series padding capacitor may be responsible. Incorrect inductance in the high frequency oscillator circuit will cause a uniformly increasing error in tracking as the Receiver is tuned from the high frequency end of the coil set tuning range to the mid-point of the tuning range. Incorrect series padding capacity (with correct inductance) will produce a tracking error which increases rapidly as the low frequency limit of the coil set tuning range is approached. It must be remembered, however, that both the circuit inductance and series padding capacity have a very definite effect upon tracking over the entire frequency range of the coil set and, in consequence, it may be difficult to determine which circuit element is at fault.

The Types CNA-47156, -47157 and -47158 Coil Sets are fitted with variable series padding capacitors, the adjustment being indicated as trimmer Number 4 in Photo No. 17.18. Capacity increases with clockwise rotation of trimmer Number 4. If any of the series padding capacitors in the Types CNA-

47159 to -47162 Coil Sets are inaccurate, the capacitor in question must be replaced, since no means of adjustment are provided.

Three types of inductive trimmers are employed in the high frequency oscillator circuits. The Types CNA-47156, -47157 and -47158 Coil Sets are each fitted with a copper ring. The position of this ring can be changed to vary its coupling with the tuned circuit inductor. Increased coupling (closer spacing) decreases the circuit inductance and vice versa. The Types CNA-47159 and CNA-47160 are each fitted with brass discs mounted inside the high frequency oscillator (solenoid) inductor. The position of the brass disc can be changed by turning a check-nut which is accessible through an opening in the rear of the high frequency oscillator transformer shield. Turning the check-nut in a clockwise direction decreases circuit inductance and vice versa. The Types CNA-47161 and CNA-47162 Coil Sets are each fitted with adjustable turns or loops which are part of the inductor winding. Inductance is increased by moving the turn or loop to provide a more complete solenoid.

If a tracking check made in accordance with Par. 14.51 shows mis-tracking at the low frequency end of the tuning range, while a similar check at the middle of the tuning range shows the tracking error to be negligible, the series padding capacitor should be re-adjusted. A tracking check indicating the need for more capacity at the low frequency end of the range shows the series padding capacitor to be too small and vice versa. If tests show tracking to be correct at the low frequency end of the tuning range but indicate that more circuit capacity is needed in the middle of the tuning range, the inductance of the oscillator tuned circuit is too low and the series padding capacity is too high. In such cases, an inductance re-adjustment should be made first to provide correct tracking from the high frequency end to the mid-point of the tuning range and only after the circuit inductance appears to be correct should the series padding capacitor be re-adjusted, or a decision be made regarding the necessity for replacing it.

There are several possible incorrect combinations of inductance and series padding capacity other than those mentioned above but, in all cases, the principles of test and adjustment are the same.

After any change or re-adjustment is made to either the high frequency oscillator circuit inductance or series padding capacity, it will be necessary to re-align the high frequency oscillator trimmer Number 5, as described under Par. 14.33. Tracking may then be re-checked.

MODEL RAS RADIO RECEIVING EQUIPMENT

15. PARTS LISTS

**15.1 LIST OF MAJOR UNITS
FOR MODEL RAS RADIO RECEIVING EQUIPMENT**

<i>Navy Type Designation</i>	<i>Name</i>	<i>Symbol Designation Group</i>
CNA-46080	RADIO RECEIVER	101-199
CNA-20089	POWER UNIT	201-299
CNA-20090	POWER UNIT	201-299
CNA-49105	LOUD SPEAKER	301-399
CNA-49106	LOUD SPEAKER	301-399
CNA-47156	COIL SET 1	401-499
CNA-47157	COIL SET 2	501-599
CNA-47158	COIL SET 3	601-699
CNA-47159	COIL SET 4	701-799
CNA-47160	COIL SET 5	801-899
CNA-47161	COIL SET 6	901-999
CNA-47162	COIL SET 7	1001-1099
CNA-10037	COIL SYSTEM CONTAINER	1101-1199
CNA-10036	MOUNTING RACK	1201-1299

IS.2 TABLE I
PARTS LIST BY SYMBOL DESIGNATIONS FOR MODEL RAS RADIO RECEIVING EQUIPMENT
SECTION I
TYPE CNA-46080 RADIO RECEIVER UNIT (101-199)

Symbol Design #	FUNCTION	Description	Navy Type Design.	Navy Dwg. Spec. Number	MFR.	MFR. Design.	Special Tolerance Rating or Modification	National Co. Dwg. and Part No.
STRUCTURAL PARTS								
A-101	Eccentric Coil Set Latch	Coil Set Latch, Left	8	CSL-L		C-233/234
A-102	Eccentric Coil Set Latch	Coil Set Latch, Right	8	CSL-R		C-233/234
CAPACITORS								
C-101	Main Tuning	Variable Air: 4 gang, 12 to 225 mmf. per section \pm 10%	8	PW4		C-218
	A First R.F. Amp. Tuning	Mica: .004 mfd. \pm 10%, 500 V DC W CAW-48983-10	RE 48AA 143D		1	1467		
	B Second R.F. Amp. Tuning	Mica: .005 mfd. \pm 10%, 300 V DC W CAW-4810372-10	RE 48A 143		1	1467		
	C First Detector Tuning	Paper: .1 mfd. \pm 20-10%, 400 V DC W CAW-481073	RE 13A 488C		1	489		
	D H.F. Oscillator Tuning	Paper: .1 mfd. \pm 20-10%, 600 V DC W CAW-481075	RE 12A 488C		1	689		
*C-102	V-101 Grid Filter	Same as C-105	CAW-481075					
*C-103	V-101 Cathode By-pass	Paper: .01 mfd. \pm 20-10%, 400 V DC W CAW-481072	RE 13A 488C		1	489		
*C-104	V-101 and V-102 Screen By-pass	Same as C-104	CAW-481073					
*C-105	V-101 B+ By-pass	Mica: .0001 mfd. \pm 10%, 500 V DC W CAW-481042-10	RE 48A 143A		1	1465		
*C-106	V-102 Grid Filter	Mica: .01 mfd. \pm 10%, 300 V DC W CAW-488848-10	RE 48A 143A		1	1467		
*C-107	V-102 Cathode By-pass	Same as C-105	CAW-481075					
*C-108	V-104 Grid	Same as C-104	CAW-481073					
*C-109	V-104 Cathode By-pass	Same as C-105	CAW-481075					
*C-110	V-104 Screen By-pass	Same as C-105	CAW-481073					
*C-111	V-102 B+ By-pass	Same as C-105	CAW-481075					
*C-112	V-103 Cathode By-pass	Same as C-105	CAW-481073					
*C-113	V-103 B+ By-pass	Same as C-105	CAW-481075					
*C-114	T-101 Primary Tuning	Variable Air: 6 to 85 mmf. \pm 10%		8			
*C-115	T-101 Secondary Tuning	Same as C-115	CAW-481072					
*C-116	V-105 Grid Filter	Same as C-104	CAW-481073					
*C-117	V-105 Cathode By-pass	Paper: 1 mfd. \pm 20 - 10%, 400 V DC W	RE 48AA 120C		1	461		
*C-118	V-105 and V-106 Screen By-pass	Same as C-104	CAW-481073					
*C-119	V-105 and V-106 B+ By-pass	Paper: 25 mfd. \pm 20 - 10%, 600 V DC W	RE 13A 488C		1	689		
*C-120	V-105 and V-106 B+ By-pass	Same as C-104	CAW-481073					

* SPARE PARTS FURNISHED refer to TABLE III for quantities.

Symbol part designation, if any.

* Assignment for REPLACEMENT USE ONLY.

15.2 TABLE I (Continued)
PARTS LIST BY SYMBOL DESIGNATIONS FOR MODEL RAS RADIO RECEIVING EQUIPMENT
SECTION 1 (Continued)
TYPE CNA-46080 RADIO RECEIVER UNIT (101-199)

Symbol	FUNCTION	DESCRIPTION	Navy Type Desig.	Navy Dwg.-Spec. Number	MFR	MFR. Desig.	Special Tolerance Rating or Modification	National Co. Dwg. and Part No.
CAPACITORS (Continued)								
C-121	T-102 Primary Tuning	Same as C-115
C-122	T-102 Secondary Tuning	Same as C-115
*C-123	V-106 Grid Filter	Same as C-107	CAW-481072
*C-124	B+ By-pass	Same as C-102	CAW-48983-10
*C-125	V-108 Heater By-pass	Same as C-104	CAW-481073
C-126	C. W. Osc. Vernier	Variable Air: 8 to 120 mmf. \pm 10%
*C-127	V-108 Screen By-pass	Same as C-104	CAW-481073
*C-128	V-108 to V-107A Coupling	Bakelite: 2 mmf. 400 V DC W
*C-129	V-106 Cathode By-pass	Same as C-104	CAW-481073
*C-130	V-107B Plate By-pass	Same as C-107	CAW-481072
C-131	T-104 Primary Tuning	Same as C-115
C-132	T-104 Secondary Tuning	Same as C-115
*C-133	V-105 Heater By-pass	Same as C-104
*C-134	V-107A Cathode By-pass	Same as C-104	CAW-481073
*C-135	V-107A Plate I.F. Filter	Electrolytic: 10 mfd. 50 V DC W	CD-481044
*C-136	V-107A Plate Audio Filter	Same as C-102	CAW-48983-10
*C-137	V-107A Plate I.F. Filter	Same as C-120	CAW-481076
*C-138	B Minus to Chassis By-pass	Mica: .0005 mfd. \pm 10%, 500 V DC W Paper: .25 mfd. +20 -10%, 400 V DC W	CAW-481043-10 CAW-481074	RE 48AA 143 RE 13A 488C	1 1	1467 489	C-284 C-279
*C-139	V-107A to V-109 Coupling	Same as C-105	CAW-481075
*C-140	T-104 to V-107B Coupling	Mica: .00025 mfd. \pm 10%, 500 V DC W	CAW-48690-10	RE 48A 148A	1	1468
*C-141	V-107B Cathode By-pass	Same as C-104	CAW-481073
*C-142	V-109 Heater By-pass	Same as C-107	CAW-481072
*C-143	B+ By-pass	Same as C-120	CAW-481076
C-144	T-103 Tuning	Same as C-115
C-145	T-103 Tuning	Same as C-115
C-146	V-108 Grid	Mica: .001 mfd. \pm 10%, 500 V DC W
*C-147	V-109 Cathode By-pass	Electrolytic: 25 mfd., 50 V DC W

* SPARE PARTS FURNISHED refer to TABLE III for quantities.

Symbol part designation, if any.

° Assignment for REPLACEMENT USE ONLY.

1 Assignment for Mfr. Desig. 1461.

15.2 TABLE I (Continued)
PARTS LIST BY SYMBOL DESIGNATIONS FOR MODEL RAS RADIO RECEIVING EQUIPMENT
SECTION 1 (Continued)
TYPE CNA-46080 RADIO RECEIVER UNIT (101-199)

Symbol Desig. #	FUNCTION	DESCRIPTION	Navy Type Desig.	Navy Dwg.-Spec. Number	MFR. Desig.	Special Tolerance Rating or Modification	National Co. Dwg. and Part No.
MISCELLANEOUS ELECTRICAL PARTS							
E-101	Antenna Input Terminals	Insulated Binding Post Assembly	8 FWK	5 Springs	B833/573
E-102	First R.F. Trans. Connectors	Contact Spring Assembly	8 SCF		
E-103	Second R.F. Trans. Connectors	Same as E-102			
E-104	First Det. Trans. Connectors	Same as E-102	8 SCF	4 Springs	
E-105	H.F. Osc. Trans. Connectors	Contact Spring Assembly	12 1720	BSW	
E-106	S-103 Terminals	Insulated Screw Terminals	12 1490	SPKR	
E-107	Loud Speaker Output	Insulated Tip Jacks	8 HC-LUG		
E-108	W-201 Shield Ground	Screw Terminal	8 T78		
E-109	V-101 Shield	Aluminum Tube Shield			
E-110	V-102 Shield	Same as E-109			
E-111	V-103 Shield	Same as E-109			
E-112	V-104 Shield	Same as E-109			
E-113	V-105 Shield	Same as E-109			
E-114	V-106 Shield	Same as E-109			
E-115	V-107 Shield	Same as E-109			
E-116	V-108 Shield	Same as E-109			
E-117	V-109 Shield	Aluminum Tube Shield	8 TS		
E-118	J-101 Shield	Aluminum Baffle	8 RAS-AB		
E-119	Socket for I-101	Pilot Lamp Socket Assembly	10 B310RR		
INDICATING DEVICES							
I-101	Pilot Lamp	6.3V., .25A. Bayonet Base	4 44		
JACKS AND RECEPTACLES							
J-101	Headphone Output	Multi-Circuit Jack	10 705B	14228	
NAMEPLATES AND DIALS							
N-101	Main Tuning Dial	Multi-Revolution, 0-500 Div.	8 PW-DN	R.F. GAIN	B-320A-2
N-102	R-115 Knob	Etched Dial "R.F. GAIN"	8 HRO-DIAL	C.W. OSC.	B-320A-3
N-103	C-126 Knob	Etched Dial "C.W. OSC."	8 HRO-DIAL	A.F. GAIN	B-320A-1
N-104	R-136 Knob	Etched Dial "A.F. GAIN"	8 RNP-S		C-287
N-105	Radio Receiver Nameplate	Etched, German Silver			
# Symbol part designation, if any.							

15.2 TABLE I (Continued)
PARTS LIST BY SYMBOL DESIGNATIONS FOR MODEL RAS RADIO RECEIVING EQUIPMENT
SECTION 1 (Continued)
TYPE CNA-46080 RADIO RECEIVER UNIT (101-199)

Symbol Design. #	FUNCTION	DESCRIPTION	Navy Type Design.	Navy Dwg.-Spec. Number	MFR.	MFR. Design.	Special Tolerance Rating or Modification	National Co. Dwg. and Part No.
PLUGS								
P-101	Power Supply Cable Connector	4 Prong with Rubber Cap	8	PCP-4		
RESISTORS								
*R-101	V-101 Grid Filter	500,000 Ohm $\pm 10\%$, $\frac{1}{2}$ Watt	CBN-63360	RE 13A 372G	2	310		
*R-102	V-101 Cathode Bias	300 Ohm $\pm 10\%$, $\frac{1}{2}$ Watt	CBN-63360	RE 13A 372G	2	310		
*R-103	V-102 Grid Filter	Same as R-101	CBN-63360		
*R-104	V-102 Cathode Bias	Same as R-102	CBN-63360		
*R-105	V-104 Grid Leak	20,000 Ohm $\pm 10\%$, $\frac{1}{2}$ Watt	CBN-63360	RE 13A 372G	2	310		
*R-106	V-101 and V-102 Screen Filter	5,000 Ohm $\pm 10\%$, $\frac{1}{2}$ Watt	CBN-63360	RE 13A 372G	2	310		
*R-107	V-103 Screen Filter	100,000 Ohm $\pm 10\%$, $\frac{1}{2}$ Watt	CBN-63360	RE 13A 372G	2	310		
*R-108	V-103 Screen Dropping	25,000 Ohm $\pm 10\%$, $\frac{1}{2}$ Watt	CBN-63360	RE 13A 372G	2	310		
*R-109	V-104 Screen Bleeder	Same as R-107	CBN-63360		
*R-110	V-103 Cathode Bias	Same as R-106	CBN-63360		
*R-111	V-103 Plate Filter	2,000 Ohm $\pm 10\%$, $\frac{1}{2}$ Watt	CBN-63360	RE 13A 372G	2	310		
*R-112	V-105 Grid Filter	Same as R-101	CBN-63360		
*R-113	T-101 Secondary Load	1 Megohm $\pm 10\%$, $\frac{1}{2}$ Watt	CBN-63360	RE 13A 372G	2	310		
*R-114	V-105 Cathode Bias	Same as R-102	CBN-63360		
*R-115	R.F. Gain Control	10,000 Ohm, 1.5 Watt, Wire Wound Variable	CMC-68756	RE 13A 492	7	P58- 10,000U		
*R-116	Voltage Divider	30,000 Ohm $\pm 10\%$, 2 Watt	CBN-63474	RE 13A 372G	2	316		
*R-117	Screen Circuit Volt. Divider	15,000 Ohm $\pm 10\%$, 2 Watt	CBN-63474	RE 13A 372G	2	316		
*R-118	V-105 and V-106 Plate Filter	Same as R-111	CBN-63360		
*R-119	V-103 Grid Leak	50,000 Ohm $\pm 10\%$, $\frac{1}{2}$ Watt	CBN-63360	RE 13A 372G	2	310		
*R-120	V-103 Screen Bleeder	Same as R-107	CBN-63360		
*R-121	V-108 Screen Dropping	Same as R-107	CBN-63360		
*R-122	V-108 Plate Filter	250,000 Ohm $\pm 10\%$, $\frac{1}{2}$ Watt	CBN-63360	RE 13A 372G	2	310		
*R-123	V-106 Grid Filter	Same as R-101	CBN-63360		
*R-124	T-102 Secondary Load	Same as R-113	CBN-63360		
*R-125	V-106 Cathode Bias	1,500 Ohm $\pm 10\%$, $\frac{1}{2}$ Watt	CBN-63360	RE 13A 372G	2	310		
*R-126	A.V.C. Filter	Same as R-101	CBN-63360		
*R-127	V-107B Plate	Same as R-107	CBN-63360		
*R-128	V-107B Grid Leak	Same as R-101	CBN-63360		

* SPARE PARTS FURNISHED refer to TABLE III for quantities.
Symbol part designation, if any.

15.2 TABLE I (Continued)
PARTS LIST BY SYMBOL DESIGNATIONS FOR MODEL RAS RADIO RECEIVING EQUIPMENT
SECTION 1 (Continued)
TYPE CNA-46080 RADIO RECEIVER UNIT (101-199)

Symbol Design. #	FUNCTION	DESCRIPTION	Navy Type Design.	Navy Dwg.-Spec. Number	MFR.	MFR. Design.	Special Tolerance Rating or Modification	National Co. Dwg. and Part No.
RESISTORS (Continued)								
*R-129	V-107B Cathode Bias	250 Ohm $\pm 10\%$, 1/4 Watt		RE 13A 372G	2	310		
*R-130	V-107B Voltage Divider	1,000 Ohm $\pm 10\%$, 2 Watt		RE 13A 372G	2	316		
*R-131	V-107B Voltage Divider	Same as R-130					
*R-132	V-107A Cathode Bias	Same as R-105					
*R-133	V-107A Plate Audio Filter	50,000 Ohm $\pm 10\%$, 1 Watt		RE 13A 372G	2	314		
*R-134	V-107A Plate	Same as R-105					
*R-135	V-107A Plate I.F. Filter	10,000 Ohm $\pm 10\%$, 1/4 Watt		RE 13A 372G	2	310		
*R-136	Audio Gain Control	600,000 Ohm, 1 Watt			72-105		
*R-137	V-109 Cathode Bias	Composition Variable					
*R-138	T-105 Primary Load	250 Ohm $\pm 10\%$, 2 Watt		RE 13A 372G	2	316		
*R-139	Heater Center Tap	Same as R-102					
		64 Ohm C.T., 3 Watt		10	864C		
SWITCHES								
S-101	CW Oscillator ON-OFF	SPST, 1 Amp, 250 Volt		CHH-24070	5	20994L		
S-102	A.V.C. ON-OFF	SPST, 1 Amp, 250 Volt		*24000	5	20992V		
S-103	B+ ON-OFF	Same as S-102		*RE 24AA 118				
TRANSFORMERS								
*T-101	V-108 to V-105 I.F. Coupling	175 Kc.		8	IFC-88		C-285 Impedance: 600 Ohms $\pm 10\%$ Sec. Load 600 Ohms $\pm 10\%$
*T-102	V-105 to V-106 I.F. Coupling	Same as T-101		8	IFCO-2		
*T-103	CW Oscillator Tuning	175 Kc.		8	IFC-89		
*T-104	V-106 to V-107A I.F. Coupling	175 Kc.		8	F-600A		
*T-105	Audio Output Coupling Primary (Black Leads)	1340 Turns #29 D.C. Res: 40 Ohms $\pm 10\%$		CNA-30497	8			
	Secondary (Yellow Leads)	1340 Turns (Total) #29 C.T. D.C. Res: C.T. to Inside 25 Ohms $\pm 10\%$, C.T. to Outside 30 Ohms $\pm 10\%$						

* SPARE PARTS FURNISHED refer to TABLE III for quantities.

Symbol part designation, if any.

* Assignment for REPLACEMENT USE ONLY.

15.2 TABLE I (Continued)
PARTS LIST BY SYMBOL DESIGNATIONS FOR MODEL RAS RADIO RECEIVING EQUIPMENT
SECTION 1 (Continued)
TYPE CNA-46080 RADIO RECEIVER UNIT (101-199)

Symbol Desig. #	FUNCTION	DESCRIPTION	Navy Type Desig.	Navy Dwg.-Spec. Number	MFR	MFR. Desig.	Special Tolerance Rating or Modification	National Co. Dwg. and Part No.
VACUUM TUBES								
*V-101	First R.F. Amplifier	R.F. Pentode	CRC-38646	RE 13A 600B	9	6D6		
*V-102	Second R.F. Amplifier	Same as V-101	CRC-38646				
*V-103	First Detector	R.F. Pentode	CRC-38636	RE 13A 600B	9	6C6		
*V-104	H.F. Oscillator	Same as V-103	CRC-38636				
*V-105	First I.F. Amplifier	Same as V-101	CRC-38646				
*V-106	Second I.F. Amplifier	Same as V-101	CRC-38646				
*V-107	A Second Detector	Dual Triode	CRC-38768F	RE 13A 600B	9	6F8G		
	B Automatic Volume Control	Part of V-107				
*V-108	C.W. Oscillator	Same as V-103	CRC-38636				
V-109	Audio Amplifier	Beam Audio Output	9	6V6G		

INTERCONNECTING CABLES

W-101	B Supply and Heater Cable	4 Wire Shielded Cable	8	HRON-PC		
-------	---------------------------	-----------------------	-------	-------	---	---------	--	--

SOCKETS

X-101	Socket for V-101	6 Prong Ceramic	CNA-38357	8	CIR-6		C-266
X-102	Socket for V-102	Same as X-101	CNA-38357				
X-103	Socket for V-103	Same as X-101	CNA-38357				
X-104	Socket for V-104	Same as X-101	CNA-38357				
X-105	Socket for V-105	Same as X-101	CNA-38357				
X-106	Socket for V-106	Same as X-101	CNA-38357				
X-107	Socket for V-107	Same as X-101	CNA-38357				
X-108	Socket for V-108	8 Prong Ceramic	CNA-38358	8	CIR-8		C-268
X-109	Socket for V-109	Same as X-108	CNA-38358				

SECTION 2
TYPES CNA-20089 AND CNA-20090 POWER UNITS (201-299)

STRUCTURAL PARTS

A-201	V-201 Compartment Cover	Framed Grille	8	SPU-CG		C-308
-------	-------------------------	---------------	-------	-------	---	--------	--	-------

* SPARE PARTS FURNISHED refer to TABLE III for quantities.
Symbol part designation, if any.
° 6V6GT may be substituted.

15.2 TABLE I (Continued)
PARTS LIST BY SYMBOL DESIGNATIONS FOR MODEL RAS RADIO RECEIVING EQUIPMENT
SECTION 2 (Continued)
TYPES CNA-20089 AND CNA-20090 POWER UNITS (201-299)

Symbol Desig. #	FUNCTION	DESCRIPTION	Navy Type Desig.	Navy Dwg.-Spec. Number	MFR.	MFR. Desig.	Special Tolerance Rating or Modification	National Co. Dwg. and Part No.
CAPACITORS								
C-201	Line By-pass, Part of T-201	Mica: .01 mfd. ± 10%, 600 V DCW	CAW-481046-10	1	1450		
C-202	B + By-pass, Part of T-201	Same as C-201	CAW-481046-10	3	TLAD6040		
*C-203	Input Filter	Paper: 4 mfd., 600 V DC W	CD-481080				
*C-204	Input Filter	Same as C-203	CD-481080				
*C-205	Output Filter	Same as C-203	CD-481080				
*C-206	Output Filter	Same as C-203	CD-481080				
MISCELLANEOUS ELECTRICAL PARTS								
E-201	W101 Shield Ground	Knurled Head Screw	8	KHS	3/8"-6/32	
FUSES								
*F-201	A.C. Line Fuse	1 Amp. Glass Enclosed	6	3AG		
*F-202	A.C. Line Fuse	Same as F-201				
JACKS AND RECEPTACLES								
J-201	A.C. Power Input	Motor Plug Cap	5	7302		
J-202	B Supply and Heater	4 Prong Socket	12	X18		
J-203	Fuse Holder	Fuse Clip Mounting	6	1068		
INDUCTORS								
*L-201	B + Filter	5000 Turns #31. D.C. Resistance, 300 Ohms ± 10%	CNA-30500	8	J4373C	17 Henry ± 20% .08 Amp.	C-327
NAMEPLATES AND DIALS								
*N-201	Power Unit Nameplate	Etched, German Silver	8	PUNP-60		C-289
*N-201	Power Unit Nameplate	Etched, German Silver	8	PUNP-25		C-290

* SPARE PARTS FURNISHED refer to TABLE III for quantities.

Symbol part designation, if any.

¹ Used only with CNA-20090 Power Unit.

² Used only with CNA-20089 Power Unit.

15.2 TABLE I (Continued)
PARTS LIST BY SYMBOL DESIGNATIONS FOR MODEL RAS RADIO RECEIVING EQUIPMENT
SECTION 2 (Continued)
TYPES CNA-20089 AND CNA-20090 POWER UNITS (201-299)

Symbol Design. #	FUNCTION	DESCRIPTION	Navy Type Design.	Navy Dwg. Spec. Number	MFR.	MFR. Design.	Special Tolerance Rating or Modification	National Co. Dwg. and Part No.
PLUGS								
P-201 P-202	A.C. Connector W-201 Connector	2 Prong, 660 W., 250 V. Cord Connector Body	13 150 5 7054			
SWITCHES								
S-201	A.C. Power Input	SPST Toggle, 1A., 250 V.	*-24000	5	20694AC		
TRANSFORMERS								
*T-201	Power Transformer Primary: (Terminals 1 and 2) 1/4 H.V. Secondary: (Terminals 3 and 4) 1/4 H.V. Secondary: (Terminals 4 and 5) V-201 Fil. Secondary: (Terminals 6 and 7) Heater Secondary: (Terminals 8 and 9) Electrostatic Shield: (Terminal G) Line By-pass: (Terminals 2 and G) B+ By-pass: (Terminals 7 and G)	110/120 Volt, 50/60 Cycle 600 Turns #24, D.C. Resistance: 8 Ohms \pm 10% 1700 Turns #35, D.C. Resistance: 380 Ohms \pm 10% 1700 Turns #35, D.C. Resistance: 420 Ohms \pm 10% 28 Turns #17, D.C. Resistance: 32 Ohms \pm 10% 36 Turns #16, D.C. Resistance: 13 Ohms \pm 10% C-201, Part of T-201 C-202, Part of T-201	CNA-30498	8	12069C	75 VA. 115 V., .65 A \pm 10%. 280 V A.C., .035 A \pm 10%. 280 V A.C., .035 A \pm 10%. 5 V A.C. 3 A \pm 10%. 6.2 V A.C. 3.4 A. \pm 10%.	C-301
**T-201	Power Transformer Primary: (Terminals 1 and 2) 1/4 H.V. Secondary: (Terminals 3 and 4)	110/120 Volt, 25 Cycle 500 Turns #24, D.C. Resistance: 13 Ohms \pm 10%. 255-0 Turns #34, D.C. Resistance: 450 Ohms \pm 10%.	CNA-30499	8	12360C	75 VA. 115 V A.C., .65 A. \pm 10%. 280 V A.C. .035 A \pm 10%.	C-301

* SPARE PARTS FURNISHED refer to TABLE III for quantities.

Symbol part designation, if any.

! Assignment for REPLACEMENT USE ONLY.

1 Used only with CNA-20090 Power Unit.

* Used only with CNA-20089 Power Unit.

15.2 TABLE I (Continued)
PARTS LIST BY SYMBOL DESIGNATIONS FOR MODEL RAS RADIO RECEIVING EQUIPMENT
SECTION 2 (Continued)
TYPES CNA-20089 AND CNA-20090 POWER UNITS (201-299)

Symbol Desig. #	FUNCTION	DESCRIPTION	Navy Type Desig.	Navy Dwg.-Spec. Number	MFR. Desig.	Special Tolerance Rating or Modification	National Co. Dwg. and Part No.
TRANSFORMERS (Continued)							
V-201	Rectifier	Full Wave Rectifier	CRC-38593	RE 13A 600B	9 5Z3		
W-201	A.C. Power Supply	2 Wire Rubber Covered	13 POSJ	8'-18/2	
VACUUM TUBES							
X-201	Socket for V-201	4 Prong Socket	12 X18	38593	
INTERCONNECTING CABLES							
SOCKETS							
SECTION 3							
TYPES CNA-49105 AND CNA-49106 LOUD SPEAKERS (301-399)							
NAMEPLATES AND DIALS							
N-301	Loud Speaker Nameplate	Etched, German Silver	8 LSNP-T		C-292
N-301	Loud Speaker Nameplate	Etched, German Silver	8 LSNP-R		C-291

1/2 H.V. Secondary: (Terminals 4 and 5)
 Resistance: 500 Ohms ±10%.
 V-201 Fil. Secondary:
 (Terminals 6 and 7)
 Resistance: .15 Ohms ±10%.
 Heater Secondary: (Terminals 8 and 9)
 Resistance: .22 Ohms ±10%.
 Electrostatic Shield:
 (Terminal G)
 Line By-pass: (Terminals 2 and G)
 B + By-pass: (Terminals 7 and G)

Symbol part designation, if any.
 * Used only with Type CNA-49106 Loud Speaker.
 † Used only with Type CNA-49105 Loud Speaker.

15.2 TABLE I (Continued)
PARTS LIST BY SYMBOL DESIGNATIONS FOR MODEL RAS RADIO RECEIVING EQUIPMENT
SECTION 3 (Continued)
TYPES CNA-49105 AND CNA-49106 LOUD SPEAKERS (301-399)

Symbol Desig. #	FUNCTION	DESCRIPTION	Navy Type Desig.	Navy Dwg.-Spec. Number	MFR. Desig.	Special Tolerance Rating or Modification	National Co. Dwg. and Part No.
TRANSFORMERS							
*T-301	Audio Coupling Primary: (Terminals 1 and 2) Secondary: (Terminals 3 and 4)	2300 Turns #36, D.C. Resistance 275 Ohms $\pm 10\%$. 52 Turns #19, D.C. Resistance .16 Ohms $\pm 10\%$.	CNA-30501	8 5537C	-5000 Ohms $\pm 20\%$ @ 400 Cycles, .045 Amps, D.C. 2.8 Ohms $\pm 20\%$ Sec. Load.	C-295
INTERCONNECTING CABLES							
W-301	Speaker Cable	2 Wire Shielded	8	PM8-SC	
LOUD SPEAKERS							
LS-301	Loud Speaker Chassis	8 Inch Size, P.M. Field	11 PMK-8		LS-301
SECTION 4 TYPE CNA-47156 COIL SET 1 (401-499)							
CAPACITORS							
C-401	T-401 Trimmer	Variable Air: 5 to 28 mmf. $\pm 10\%$	8		
C-402	T-402 Trimmer	Same as C-401			
C-403	T-403 Trimmer	Same as C-401			
C-404	T-404 Trimmer	Same as C-401			
C-405	T-404 Series Padding	Variable Air: 7 to 60 mmf.	8		
*C-406	T-404 Series Padding	Mica: .0003 mfd. $\pm 3\%$, 500 V DC W	CAW-48854-3	RE 48A 143	1 1467		

* SPARE PARTS FURNISHED refer to TABLE III for quantities.
Symbol part designation, if any.

15.2 TABLE I (Continued)
PARTS LIST BY SYMBOL DESIGNATIONS FOR MODEL RAS RADIO RECEIVING EQUIPMENT
SECTION 4 (Continued)
TYPE CNA-47156 COIL SET 1 (401-499)

Symbol Desig.	#	FUNCTION	DESCRIPTION	Navy Type Design.	Navy Dwg. Spec. Number	MFR.	MFR. Desig.	Special Tolerance Rating or Modification	National Co. Dwg. and Part No.
INDUCTORS									
L-401		T-401 Coil Primary: (Terminals 4 and 5) D.C. Resistance: 2.5 Ohms \pm 15%. Secondary: (Terminals 1 and 3) D.C. Resistance: 14 Ohms \pm 15%.	8	95S		
L-402		T-402 Coil Primary: (Terminals 4 and 5) D.C. Resistance: 225 Ohms \pm 15%. Secondary: (Terminals 1 and 3) D.C. Resistance: 14 Ohms \pm 15%.	8	42S		
L-403		T-403 Coil Primary: (Terminals 4 and 5) D.C. Resistance: 3 Ohms \pm 15%. Secondary: (Terminals 1 and 3) D.C. Resistance: 14 Ohms \pm 15%.	8	96S-RF		
L-404		T-404 Coil Tap: (Terminals 4 and 5) Total: (Terminals 2 and 4) D.C. Resistance: 2.4 Ohms \pm 15%. D.C. Resistance: 9 Ohms \pm 15%.	8	96S-D		
L-405		T-405 Coil Tap: (Terminals 4 and 5) Total: (Terminals 2 and 4) D.C. Resistance: 2.4 Ohms \pm 15%. D.C. Resistance: 9 Ohms \pm 15%.	8	97N		
NAMEPLATES AND DIALS									
N-401		Coil Set 1 Nameplate	Etched, German Silver	8	CSNP-S1		C-241
N-402		Calibration Chart and Frame	Framed Chart Assembly	8	NCF-S1		
N-403		Logging Chart and Frame	Framed Chart Assembly	8	NCF-SL		
TRANSFORMERS									
T-401		E-101 to V-101 Coupling	R.F. Transformer Assembly, Coil Set 1	8	G5E		
T-402		V-101 to V-102 Coupling	R.F. Transformer Assembly, Coil Set 1	8	G6E		
T-403		V-102 to V-103 Coupling	R.F. Transformer Assembly, Coil Set 1	8	G7E		
T-404		H.F. Osc. Inductor Assembly	R.F. Transformer Assembly, Coil Set 1	8	G8E		
# Symbol part designation, if any.									

15.2 TABLE I (Continued)
PARTS LIST BY SYMBOL DESIGNATIONS FOR MODEL RAS RADIO RECEIVING EQUIPMENT
SECTION 5
TYPE CNA-47157 COIL SET 2 (501-599)

Symbol	FUNCTION	DESCRIPTION	Navy Type Desig.	Navy Dwg.-Spec. Number	MFR.	MFR. Desig.	Special Tolerance Rating or Modification	National Co. Dwg. and Part No.
Desig. #								
CAPACITORS								
C-501	T-501 Trimmer	Variable Air: 6 to 38 mmf. $\pm 10\%$. Same as C-501 Same as C-501 Same as C-501 Variable Air: 8 to 68 mmf. $\pm 10\%$. Mica: .0007 mfd. $\pm 3\%$, 500 V DC W	8			
C-502	T-502 Trimmer					
C-503	T-503 Trimmer					
C-504	T-504 Trimmer					
C-505	T-504 Series Padding		8			
*C-506	T-504 Series Padding		CAW-481016-3	RE 48A 143	1	1467		
INDUCTORS								
L-501	T-501 Coil Primary: (Terminals 4 and 5) Secondary: (Terminals 1 and 3)	D.C. Resistance: .8 Ohms $\pm 15\%$. D.C. Resistance: 4.5 Ohms $\pm 15\%$	8	91S		
L-502	T-502 Coil Primary: (Terminals 4 and 5) Secondary: (Terminals 1 and 3)	D.C. Resistance: 44 Ohms $\pm 15\%$	8	1S		
L-503	T-502 Coil Secondary: (Terminals 1 and 3)	D.C. Resistance: 4.5 Ohms $\pm 15\%$	8	98S		
L-504	T-503 Coil Primary: (Terminals 4 and 5) Secondary: (Terminals 1 and 3)	D.C. Resistance: .16 Ohms $\pm 15\%$. D.C. Resistance: 4.5 Ohms $\pm 15\%$	8	98S		
L-505	T-504 Coil Tap: (Terminals 4 and 5) Total: (Terminals 2 and 4)	D.C. Resistance: 5 Ohms $\pm 15\%$. D.C. Resistance: 10 Ohms $\pm 15\%$	8	94S		
NAMEPLATES AND DIALS								
N-501	Coil Set 2 Nameplate	Etched, German Silver Framed Chart Assembly Framed Chart Assembly	8	CSNP-S2		C-241
N-502	Calibration Chart and Frame		8	NCF-S2		
N-503	Logging Chart and Frame		8	NCF-SL		
* SPARE PARTS FURNISHED refer to TABLE III for quantities.								
# Symbol part designation, if any.								

15.2 TABLE I (Continued)
PARTS LIST BY SYMBOL DESIGNATIONS FOR MODEL RAS RADIO RECEIVING EQUIPMENT
SECTION 5 (Continued)
TYPE CNA-47157 COIL SET 2 (501-599)

Symbol Desig. #	FUNCTION	DISCUSSION	Navy Type Desig.	Navy Desig.-Spec. Number	MFR.	MFR, Desig.	Special Tolerance Rating or Modification	National Co. Dwg. and Part No.
TRANSFORMERS								
T-501	E-101 to V-101 Coupling	R.F. Transformer Assembly, Coil Set 2.	8	F5E		
T-502	V-101 to V-102 Coupling	R.F. Transformer Assembly, Coil Set 2.	8	F6E		
T-503	V-102 to V-103 Coupling	R.F. Transformer Assembly, Coil Set 2.	8	F7E		
T-504	H.F. Osc. Inductor Assembly	R.F. Transformer Assembly, Coil Set 2.	8	F8E		

SECTION 6
TYPE CNA-47158 COIL SET 3 (601-699)

CAPACITORS

C-601	T-601 Trimmer	Variable Air: 5 to 28 mmf. $\pm 10\%$	8			
C-602	T-602 Trimmer	Same as C-601				
C-603	T-603 Trimmer	Same as C-601				
C-604	T-604 Trimmer	Same as C-601				
C-605	T-604 Series Padding	Variable Air: 6 to 38 $\pm 10\%$	8			
*C-606	T-604 Series Padding	Mica: .0012 mfd. $\pm 3\%$, 500 V DC W	CA W-481084-3	RE 48A 143	1	1467		

INDUCTORS

L-601	T-601 Coil Primary: (Terminals 4 and 5) Secondary: (Terminals 1 and 8)	D.C. Resistance: .6 Ohms $\pm 15\%$ D.C. Resistance: 2.1 Ohms $\pm 15\%$	8	126S		
L-602	T-602 Coil		8	117S		
L-603	T-602 Coil Primary: (Terminals 4 and 5) Secondary: (Terminals 1 and 3)	D.C. Resistance: 25 Ohms $\pm 15\%$ D.C. Resistance: 2.1 Ohms $\pm 15\%$	8	102S-RF		
L-604	T-603 Coil Primary: (Terminals 4 and 5) Secondary: (Terminals 1 and 3)	D.C. Resistance: 3 Ohms $\pm 15\%$ D.C. Resistance: 2.1 Ohms $\pm 15\%$	8	102S-D		

* SPARE PARTS FURNISHED refer to TABLE III for quantities.
Symbol part designation, if any.

15.2 TABLE I (Continued)
PARTS LIST BY SYMBOL DESIGNATIONS FOR MODEL RAS RADIO RECEIVING EQUIPMENT
SECTION 6 (Continued)
TYPE CNA-47158 COIL SET 3 (601-699)

Symbol Desig. #	FUNCTION	DESCRIPTION	Navy Type Desig.	Navy Dwg.-Spec. Number	MFR. Desig.	Special Tolerance Rating Dwg. and or Modification	National Co. Dwg. and Part No.
INDUCTORS (Continued)							
L-605	T-604 Coil Tap: (Terminals 4 and 5) Total: (Terminals 2 and 4)	D.C. Resistance: .6 Ohms \pm 15% D.C. Resistance: 1.9 Ohms \pm 15%	8	90S	
NAMEPLATES AND DIALS							
N-601 N-602 N-603 N-604	Coil Set 3 Nameplate Calibration Chart and Frame Logging Chart and Frame	Etched, German Silver Framed Chart Assembly Framed Chart Assembly	8	CSNP-S3 NCF-S3 NCF-SL	C-241
TRANSFORMERS							
T-601 T-602 T-603 T-604	E-101 to V-101 Coupling V-101 to V-102 Coupling V-102 to V-103 Coupling H.F. Osc. Inductor Assembly	R.F. Transformer Assembly, Coil Set 3 R.F. Transformer Assembly, Coil Set 3 R.F. Transformer Assembly, Coil Set 3 R.F. Transformer Assembly, Coil Set 3	8	E5E E6E E7E E8E	
SECTION 7							
TYPE CNA-47159 COIL SET 4 (701-799)							
CAPACITORS							
C-701 C-702 C-703 C-704 *C-705	T-701 Trimmer T-702 Trimmer T-703 Trimmer T-704 Trimmer T-705 Series Padding	Variable Air: 5 to 28 mmf. \pm 10% Same as C-701 Same as C-701 Same as C-701 Mica: .0026 mfd. \pm 3%, 500 V DC W	8	RE 48A 143 CAW-481085-3	1487
INDUCTORS							
L-701	T-701 Coil Primary: (Terminals 4 and 5) Secondary: (Terminals 1 and 3)	D.C. Resistance: .6 Ohms \pm 15% D.C. Resistance: .8 Ohms \pm 15%	8	D1S	

* SPARE PARTS FURNISHED refer to TABLE III for quantities.
Symbol part designation, if any.

15.2 TABLE I (Continued)
PARTS LIST BY SYMBOL DESIGNATIONS FOR MODEL RAS RADIO RECEIVING EQUIPMENT
SECTION 7 (Continued)
TYPE CNA-47159 COIL SET 4 (701-799)

Symbol Design. #	FUNCTION	DESCRIPTION	Navy Type Design.	Navy Dwg. Spec. Number	MFR.	MFR. Design.	Special Tolerance Rating or Modification	National Co. Dwg. and Part No.
INDUCTORS (Continued)								
L-702	T-702 Coil Primary: (Terminals 4 and 5)	D.C. Resistance: 13 Ohms \pm 15%	8	116S		
L-703	T-702 Coil Secondary: (Terminals 1 and 3)	D.C. Resistance: .8 Ohms \pm 15%	8	D2S		
L-704	T-703 Coil Primary: (Terminals 4 and 5)	D.C. Resistance: 13 Ohms \pm 15%	8	116S		
L-705	T-703 Coil Secondary: (Terminals 1 and 3)	D.C. Resistance: .8 Ohms \pm 15%	8	D3S		
L-706	T-704 Coil Tap: (Terminals 4 and 5) Total: (Terminals 2 and 4)	D.C. Resistance: .17 Ohms \pm 15% D.C. Resistance: .8 Ohms \pm 15%	8	D4S		

NAMEPLATES AND DIALS								
N-701	Coil Set 4 Nameplate	Etched, German Silver	8	CSNP-54		C-241
N-702	Calibration Chart and Frame	Framed Chart Assembly	8	NCF-S4		
N-703	Logging Chart and Frame	Framed Chart Assembly	8	NCF-SL		

TRANSFORMERS								
T-701	E-101 to V-101 Coupling	R.F. Transformer Assembly, Coil Set 4	8	D5E		
T-702	V-101 to V-102 Coupling	R.F. Transformer Assembly, Coil Set 4	8	D6E		
T-703	V-102 to V-103 Coupling	R.F. Transformer Assembly, Coil Set 4	8	D7E		
T-704	H.F. Osc. Inductor Assembly	R.F. Transformer Assembly, Coil Set 4	8	D8E		

SECTION 8								
TYPE CNA-47160 COIL SET 5 (801-899)								
CAPACITORS								
C-801	T-801 Trimmer	Variable Air: 5 to 28 mmf. \pm 10%	8			
C-802	T-802 Trimmer	Same as C-801				
C-803	T-803 Trimmer	Same as C-801				
C-804	T-804 Trimmer	Same as C-801				
*C-805	T-804 Series Padding	Mica: .0051 mfd. \pm 3%, 300 V DC W	CAW-481086-3	RE 48A 143	1	1467		

* SPARE PARTS FURNISHED refer to TABLE III for quantities.
 * Symbol part designation, if any.

15.2 TABLE I (Continued)
PARTS LIST BY SYMBOL DESIGNATIONS FOR MODEL RAS RADIO RECEIVING EQUIPMENT
SECTION 8 (Continued)
TYPE CNA-47160 COIL SET 5 (801-899)

Symbol Design. #	FUNCTION	Description	Navy Type Design.	Navy Dwg.-Spec. Number	MFR.	MFR. Desig.	Special Tolerance Rating or Modification	National Co. Dwg. and Part No.
INDUCTORS								
L-801	T-801 Coil Primary: (Terminals 4 and 5) Secondary: (Terminals 1 and 3)	D.C. Resistance: .35 Ohms \pm 15% D.C. Resistance: 2 Ohms \pm 15%	8	C1S		
L-802	T-802 Coil Primary: (Terminals 4 and 5) Secondary: (Terminals 1 and 3)	D.C. Resistance: 6 Ohms \pm 15%	8	115S		
L-803	T-803 Coil Primary: (Terminals 4 and 5) Secondary: (Terminals 1 and 3)	D.C. Resistance: 2 Ohms \pm 15%	8	C2S		
L-804	T-803 Coil Primary: (Terminals 4 and 5) Secondary: (Terminals 1 and 3)	D.C. Resistance: 6 Ohms \pm 15%	8	115S		
L-805	T-803 Coil Primary: (Terminals 4 and 5) Secondary: (Terminals 1 and 3)	D.C. Resistance: 2 Ohms \pm 15%	8	C3S		
L-806	T-804 Coil Tap: (Terminals 4 and 5) Total: (Terminals 2 and 4)	D.C. Resistance: .06 Ohms \pm 15% D.C. Resistance: 2 Ohms \pm 15%	8	C4S		
NAMEPLATES AND DIALS								
N-801	Coil Set 5 Nameplate	Etched, German Silver	8	CSNF-S5		C-241
N-802	Calibration Chart and Frame	Framed Chart Assembly	8	NCF-S5		
N-803	Logging Chart and Frame	Framed Chart Assembly	8	NCF-SL		
TRANSFORMERS								
T-801	E-101 to V-101 Coupling	R.F. Transformer Assembly, Coil Set 5	8	C3E		
T-802	V-101 to V-102 Coupling	R.F. Transformer Assembly, Coil Set 5	8	C6E		
T-803	V-102 to V-103 Coupling	R.F. Transformer Assembly, Coil Set 5	8	C7E		
T-804	H.F. Osc. Inductor Assembly	R.F. Transformer Assembly, Coil Set 5	8	C8E		

* SPARE PARTS FURNISHED refer to TABLE III for quantities.
Symbol part designation, if any.

15.2 TABLE 1 (Continued)
PARTS LIST BY SYMBOL DESIGNATIONS FOR MODEL RAS RADIO RECEIVING EQUIPMENT
SECTION 9
TYPE CNA-47161 COIL SET 6 (901-999)

Symbol Design. #	FUNCTION	Description	Navy Type Design.	Navy Dwg.-Spec. Number	MFL Design.	Special Tolerance Rating, National Co. or Modification	Part No. National Co. Dwg. and
CAPACITORS							
C-901	T-901 Trimmer	Variable Air: 5 to 28 mmf. $\pm 10\%$	8
C-902	T-902 Trimmer	Same as C-901
C-903	T-903 Trimmer	Same as C-901
C-904	T-904 Trimmer	Same as C-901
C-905	T-904 Series Padding	Mica: .0088 mid. $\pm 3\%$, 300 V DC W	CA W-481087-3	RE 48A 143	1	1467
INDUCTORS							
L-901	T-901 Coil Primary: (Terminals 4 and 5) Secondary: (Terminals 1 and 3)	D.C. Resistance: .27 Ohms $\pm 15\%$ D.C. Resistance: .98 Ohms $\pm 15\%$	8	B1S
L-902	T-902 Coil Primary: (Terminals 4 and 5) Secondary: (Terminals 1 and 3)	D.C. Resistance: .3 Ohms $\pm 15\%$	8	B1AS
L-903	T-903 Coil Primary: (Terminals 4 and 5) Secondary: (Terminals 1 and 3)	D.C. Resistance: .08 Ohms $\pm 15\%$	8	B2S
L-904	T-903 Coil Primary: (Terminals 4 and 5) Secondary: (Terminals 1 and 3)	D.C. Resistance: .2 Ohms $\pm 15\%$ D.C. Resistance: .08 Ohms $\pm 15\%$	8	B3S
L-905	T-904 Coil Tap: (Terminals 4 and 5) Total: (Terminals 2 and 4)	D.C. Resistance: .06 Ohms $\pm 15\%$ D.C. Resistance: .09 Ohms $\pm 15\%$	8	B4S
NAMEPLATES AND DIALS							
N-901	Coil Set 6 Nameplate	Etched, German Silver	8	CSNF-S6	C-241
N-902	Calibration Chart and Frame	Framed Chart Assembly	8	NCF-S6
N-903	Logging Chart and Frame	Framed Chart Assembly	8	NCF-SL
TRANSFORMERS							
T-901	E-101 to V-101 Coupling	R.F. Transformer Assembly, Coil Set 6	8	B5E
T-902	V-101 to V-102 Coupling	R.F. Transformer Assembly, Coil Set 6	8	B6E
T-903	V-102 to V-103 Coupling	R.F. Transformer Assembly, Coil Set 6	8	B7E
T-904	H.F. Osc. Inductor A assembly	R.F. Transformer A assembly, Coil Set 6	8	B8E

* SPARE PARTS FURNISHED refer to TABLE III for quantities.
Symbol part designation, if any.

15-2 TABLE I (Continued)
PARTS LIST BY SYMBOL DESIGNATIONS FOR MODEL RAS RADIO RECEIVING EQUIPMENT
SECTION 10
TYPE CNA-47162 COIL SET 7 (1001-1099)

Symbol Design. #	FUNCTION	DESCRIPTION	Navy Type Design.	Navy Dwg.-Spec. Number	MFR. MFR.	MFR. Design.	Special Tolerance Rating or Modification	National Co. Dwg. and Part No.
CAPACITORS								
C-1001	T-1001 Trimmer	Variable Air. 5 to 28 mmf. ±10%			8			
*C-1002	T-1001 Series Padding	Mica: .0012 mfd. ±3%, 500 V DC W	CA W-481084-3	RE 48A 143	1	1467		
*C-1003	T-1001 Primary Series	Mica: .00094 mfd. ±10%, 500 V DC W	CA W-481077-10	RE 48A 148	1	1468		
C-1004	T-1002 Trimmer	Same as C-1001						
C-1005	T-1003 Trimmer	Same as C-1001						
C-1006	T-1004 Trimmer	Same as C-1001						
*C-1007	T-1004 Series Padding	Mica: .001 mfd. ±3%, 500 V DC W	CA W-48983-3	RE 48A 143	1	1467		
INDUCTORS								
L-1001	T-1001 Coil Primary: (Terminals 4 and 5) Secondary: (Terminals 1 and 3)	D.C. Resistance: Inf. D.C. Resistance: .04 Ohms ±15%			8	A1S		
L-1002	T-1002 Coil Primary: (Terminals 4 and 5) Tuned Secondary: (Terminals 2 and 3) A periodic Secondary: (Terminals 1 and 3)	D.C. Resistance: .8 Ohms ±15% D.C. Resistance: .06 Ohms ±15% D.C. Resistance: 6 Ohms ±15%			8	A2S		
L-1003	T-1003 Coil Primary: (Terminals 4 and 5) Tuned Secondary: (Terminals 2 and 3) A periodic Secondary: (Terminals 1 and 3)	D.C. Resistance: .8 Ohms ±15% D.C. Resistance: .06 Ohms ±15% D.C. Resistance: 6 Ohms ±15%			8	A3S		
L-1004	T-1004 Coil Tap: (Terminals 4 and 5) Total: (Terminals 2 and 4)	D.C. Resistance: .08 Ohms ±15% D.C. Resistance: .07 Ohms ±15%			8	A4S		
NAMEPLATES AND DIALS								
N-1001	Coil Set 7 Nameplate	Etched, German Silver			8	C5NP-S7		C-241
N-1002	Calibration Chart and Frame	Franced Chart A assembly			8	NCP-S7		
N-1003	Logging Chart and Frame	Franced Chart A assembly			8	NCP-SL		

* SPA RE PARTS FURNISHED refer to TABLE III for quantities.
Symbol part designation, if any.

**15.3 TABLE II
PARTS LIST BY NAVY TYPE NUMBERS FOR MODEL RAS RADIO RECEIVING EQUIPMENT**

RADIO RECEIVER POWER UNITS LOUD SPEAKERS COIL SET 1 COIL SET 2 COIL SET 3		COIL SET 4 COIL SET 5 COIL SET 6 COIL SET 7 COIL SYSTEM CONTAINER MOUNTING RACK		(701-799) (801-899) (901-999) (1001-1099) (1101-1199) (1201-1299)			
Quantity	Navy Type No.	All Symbol Designations Involved	Description	Quantity	Navy Type No.	All Symbol Designations Involved	Description
MISCELLANEOUS (CLASS 10)							
1	A-101		Coil Set Latch, Left	1	N-902		Framed Chart Assembly
1	A-102		Coil Set Latch, Right	1	N-1002		Framed Chart Assembly
1	A-201		Framed Grille Cover	7	N-403, 503, 603, 703, 803, 903, 1003		Framed Chart Assembly
1	A-1101		Cupboard Catch	1	N-1101		Coil Container Nameplate
1	E-101		Insulated Binding Posts	1	N-1102		Equipment Nameplate
4	E-102, 103, 104, 105		Contact Spring Assembly	1	N-1102		Equipment Nameplate
1	E-106		Insulated Screw Terminals	1	N-1103		Acceptance Nameplate
1	E-107		Insulated Tip Jacks	1	N-1201		Mounting Rack Nameplate
1	E-108		Screw Terminal	1	W-101		4 Wire Shielded Cable
8	E-109, 110, 111, 112, 113, 114, 115, 116		Aluminum Tube Shield	1	W-201		2 Wire Rubber Covered Cable
1	E-117		Aluminum Tube Shield	1	W-301		2 Wire Shielded Cable
1	E-118		Aluminum Baffle	SWITCHES (CLASS 24)			
1	E-119		Pilot Lamp Socket Assembly	1	S-101		
1	E-201		Knurled Head Screw	3	S-102, 103, 201		
1	I-101		6.3V., 25A. Bayonet Base Lamp	FUSES (CLASS 28)			
1	N-101		Multi-Revolution, 0-500 Dial	2	F-201, 202		1 Amp. Glass Enclosed
1	N-102		Etched Dial "R.F. Gain"	A.F. REACTORS AND TRANSFORMERS (CLASS 30)			
1	N-103		Etched Dial "C.W. Osc."	1	L-201		
1	N-104		Etched Dial "A.F. Gain"	1	T-105		
1	N-105		Radio Receiver Nameplate	1	T-201		
1	N-201		Power Unit Nameplate	1	T-201		
1	N-201		Power Unit Nameplate	1	T-301		
1	N-301		Loud Speaker Nameplate	VACUUM TUBES AND SOCKETS (CLASS 38)			
1	N-301		Loud Speaker Nameplate	1	V-201		
1	N-401		Coil Set 1 Nameplate	3	V-103, 104, 108		
1	N-501		Coil Set 2 Nameplate	4	V-101, 102, 105, 106		
1	N-601		Coil Set 3 Nameplate	1	V-107		
1	N-701		Coil Set 4 Nameplate	1	V-109		Beam Audio Output
1	N-801		Coil Set 5 Nameplate	7	X-101, 102, 103, 104, 105, 106, 107		
1	N-901		Coil Set 6 Nameplate				
1	N-1001		Coil Set 7 Nameplate				
1	N-402		Framed Chart Assembly	Assignment for Replacement Use Only.			
1	N-502		Framed Chart Assembly	1 Used only with Type CNA-20090 Power Unit.			
1	N-602		Framed Chart Assembly	2 Used only with Type CNA-20089 Power Unit.			
1	N-702		Framed Chart Assembly	3 Used only with Type CNA-49106 Loud Speaker.			
1	N-802		Framed Chart Assembly	4 Used only with Type CNA-49105 Loud Speaker.			

15.3 TABLE II (Continued)

PARTS LIST BY NAVY TYPE NUMBERS FOR MODEL RAS RADIO RECEIVING EQUIPMENT

Quantity	Navy Type No.	Description		Quantity	Navy Type No.	Description
		All Symbol Designations Involved	TUBES AND SOCKETS (CLASS 38) (Continued)			
2	-38758	X-108, 109	4. Proang Socket			
1		X-201				
R.F. INDUCTORS AND TRANSFORMERS (CLASS 47)						
1		L-401	Pri: D.C. Res., 2.5 Ohms \pm 15%	1	L-901	Total: D.C. Res., 27 Ohms \pm 15%
			Sec: D.C. Res., 34 Ohms \pm 15%	1	L-902	Pri: D.C. Res., 27 Ohms \pm 15%
1		L-402	Pri: D.C. Res., 225 Ohms \pm 15%	1	L-903	Pri: D.C. Res., 3 Ohms \pm 15%
1		L-403	Sec: D.C. Res., 14 Ohms \pm 15%	1	L-904	Sec: D.C. Res., 27 Ohms \pm 15%
1		L-404	Pri: D.C. Res., 3 Ohms \pm 15%	1		Pri: D.C. Res., 2 Ohms \pm 15%
1		L-405	Sec: D.C. Res., 14 Ohms \pm 15%	1	L-905	Sec: D.C. Res., 27 Ohms \pm 15%
1			Tap: D.C. Res., 2.4 Ohms \pm 15%	1	L-1001	Total: D.C. Res., .06 Ohms \pm 15%
1		L-501	Total: D.C. Res., 9 Ohms \pm 15%	1		Pri: D.C. Res., Inf.
1		L-502	Pri: D.C. Res., 8 Ohms \pm 15%	1	L-1002	Sec: D.C. Res., 4 Ohms \pm 15%
1		L-503	Sec: D.C. Res., 4.5 Ohms \pm 15%	1		Pri: D.C. Res., 8 Ohms \pm 15%
1		L-504	Pri: D.C. Res., 44 Ohms \pm 15%	1	L-1003	Tap: Sec: D.C. Res., .06 Ohms \pm 15%
1		L-505	Sec: D.C. Res., 4.5 Ohms \pm 15%	1		Pri: D.C. Res., 8 Ohms \pm 15%
1		L-506	Pri: D.C. Res., 46 Ohms \pm 15%	1	L-1004	Tap: Sec: D.C. Res., .03 Ohms \pm 15%
1		L-601	Sec: D.C. Res., 45 Ohms \pm 15%	1		Total: D.C. Res., .07 Ohms \pm 15%
1		L-602	Tap: D.C. Res., 5 Ohms \pm 15%	2	T-101, 102	175 K.C. I. F. Trans.
1		L-603	Total: D.C. Res., 10 Ohms \pm 15%	1	T-103	175 K.C. I. F. Trans.
1		L-604	Pri: D.C. Res., 6 Ohms \pm 15%	1	T-104	R.F. Trans. Assem. Coil Set 1
1		L-605	Sec: D.C. Res., 21 Ohms \pm 15%	1	T-401	R.F. Trans. Assem. Coil Set 1
1		L-701	Pri: D.C. Res., 25 Ohms \pm 15%	1	T-402	R.F. Trans. Assem. Coil Set 1
1		L-702	Sec: D.C. Res., 21 Ohms \pm 15%	1	T-403	R.F. Trans. Assem. Coil Set 1
1		L-703	Pri: D.C. Res., 3 Ohms \pm 15%	1	T-404	R.F. Trans. Assem. Coil Set 1
1		L-704	Sec: D.C. Res., 21 Ohms \pm 15%	1	T-501	R.F. Trans. Assem. Coil Set 2
1		L-705	Tap: D.C. Res., 6 Ohms \pm 15%	1	T-502	R.F. Trans. Assem. Coil Set 2
1		L-706	Total: D.C. Res., 19 Ohms \pm 15%	1	T-503	R.F. Trans. Assem. Coil Set 2
1		L-801	Pri: D.C. Res., 6 Ohms \pm 15%	1	T-504	R.F. Trans. Assem. Coil Set 2
1		L-802	Sec: D.C. Res., 13 Ohms \pm 15%	1	T-601	R.F. Trans. Assem. Coil Set 3
1		L-803	Pri: D.C. Res., 8 Ohms \pm 15%	1	T-602	R.F. Trans. Assem. Coil Set 3
1		L-804	Sec: D.C. Res., 13 Ohms \pm 15%	1	T-603	R.F. Trans. Assem. Coil Set 3
1		L-805	Pri: D.C. Res., 8 Ohms \pm 15%	1	T-701	R.F. Trans. Assem. Coil Set 4
1		L-806	Sec: D.C. Res., 17 Ohms \pm 15%	1	T-702	R.F. Trans. Assem. Coil Set 4
1			Total: D.C. Res., 8 Ohms \pm 15%	1	T-703	R.F. Trans. Assem. Coil Set 4
1			Pri: D.C. Res., 35 Ohms \pm 15%	1	T-704	R.F. Trans. Assem. Coil Set 4
1			Sec: D.C. Res., 2 Ohms \pm 15%	1	T-801	R.F. Trans. Assem. Coil Set 4
1			Pri: D.C. Res., 6 Ohms \pm 15%	1	T-802	R.F. Trans. Assem. Coil Set 4
1			Sec: D.C. Res., 2 Ohms \pm 15%	1		
1			Pri: D.C. Res., 6 Ohms \pm 15%	1		
1			Sec: D.C. Res., 2 Ohms \pm 15%	1		
1			Pri: D.C. Res., 2 Ohms \pm 15%	1		
1			Sec: D.C. Res., 6 Ohms \pm 15%	1		
1			Tap: D.C. Res., .06 Ohms \pm 15%	1		

1 Used only with Type CNA-20990 Power Unit.

2 Used only with Type CNA-20089 Power Unit.

15.3 TABLE II (Continued)
PARTS LIST BY NAVY TYPE NUMBERS FOR MODEL RAS RADIO RECEIVING EQUIPMENT

Quantity	Navy Type No.	All Symbol Designations Involved	Description	Quantity	Navy Type No.	All Symbol Designations Involved	Description
R.F. INDUCTORS AND TRANSFORMERS (CLASS 47) (Continued)							
1	T-803		R.F. Trans. Assem. Coil Set 5	1	C-128		Bakelite: 2 mmf. 400 V DC W
1	T-804		R.F. Trans. Assem. Coil Set 5	24	C-401, 402, 403, 404, 601, 602, 603, 604, 701, 702, 703, 704, 801, 802, 803, 804, 901, 902, 903, 904, 1001, 1004, 1005, 1006		Var. Air: 5 to 28 mmf. ±10%
1	T-901		R.F. Trans. Assem. Coil Set 6		C-405		Var. Air: 7 to 60 mmf. ±10%
1	T-902		R.F. Trans. Assem. Coil Set 6		C-501, 502, 503, 504, 605		Var. Air: 6 to 38 mmf. ±10%
1	T-903		R.F. Trans. Assem. Coil Set 6		C-505		Var. Air: 8 to 68 mmf. ±10%
1	T-904		R.F. Trans. Assem. Coil Set 6		JACKS, PLUGS, RECEPTACLES AND LOUD SPEAKERS (CLASS 49)		
1	T-1001		R.F. Trans. Assem. Coil Set 7	1	J-101		Multi-Circuit Jack
1	T-1002		R.F. Trans. Assem. Coil Set 7	1	J-201		Motor Plug Cap
1	T-1003		R.F. Trans. Assem. Coil Set 7	1	J-202		4 Prong Socket
1	T-1004		R.F. Trans. Assem. Coil Set 7	1	J-203		Fuse Clip Mounting
CAPACITORS (CLASS 48)							
1	*-48286A			1	P-101		4 Prong with Rubber Cap
1	-48690-10			1	P-201		2 Prong, 660 W., 250 V.
1	*L-48695-10			1	P-202		Cord Connector Body
1	-48848-10			1	LS-301		8 inch Size, PM Field
1	-48854-3			RESISTORS (CLASS 63)			
1	-48983-3			1	R-133		50,000 Ohms
3	-48983-10			1	R-129		250 Ohms
1	-481016-3			4	R-102, 104, 114, 138		300 Ohms
1	-481037-10			1	R-125		1,500 Ohms
1	C-103			2	R-111, 118		2,000 Ohms
1	-481042-10			2	R-106, 110		5,000 Ohms
1	-481043-10			1	R-135		10,000 Ohms
1	-481044			3	R-105, 132, 134		20,000 Ohms
1	-481045			1	R-108		25,000 Ohms
2	-481046-10			1	R-119		50,000 Ohms
5	-481072			5	R-107, 109, 120, 121, 127		100,000 Ohms
9	-481073			1	R-122		250,000 Ohms
1	-481074			6	R-101, 103, 112, 123, 126, 128		500,000 Ohms
6	-481075			2	R-113, 124		1 Megohm
3	-481076			1	R-137		250 Ohms
1	-481077-10			2	R-130, 131		1,000 Ohms
4	-481080			1	R-117		15,000 Ohms
2	-481084-3			1	R-116		30,000 Ohms
1	-481085-3			1	R-139		
1	-481086-3			1	R-115		
1	-481087-3			1	R-136		
1			1			
8	C-115, 116, 121, 122, 131, 132, 144, 145		Var. Air: 4 gang, 12 to 225 mmf. per section ±10% Var. Air: 6 to 85 mmf. ±10%				
1	C-126		Var. Air: 8 to 120 mmf. ±10%				

* Assignment for Mfr. Design. 1461.
 ° Assignment for Replacement Use Only.

MODEL RAS RADIO RECEIVING EQUIPMENT

15.4 TABLE III

**SPARE PARTS LIST BY NAVY TYPE DESIGNATIONS
FOR MODEL RAS RADIO RECEIVING EQUIPMENT**

Navy Type	Name	Symbol Group
CNA-46080	RADIO RECEIVER	101-199
CNA-20089	POWER UNIT	201-299
CNA-20090	POWER UNIT	201-299
CNA-49105	LOUD SPEAKER	301-399
CNA-49106	LOUD SPEAKER	301-399
CNA-47156	COIL SET 1	401-499
CNA-47157	COIL SET 2	501-599
CNA-47158	COIL SET 3	601-699
CNA-47159	COIL SET 4	701-799
CNA-47160	COIL SET 5	801-899
CNA-47161	COIL SET 6	901-999
CNA-47162	COIL SET 7	1001-1099

Quantity	Navy Type Desig.	All Symbol Designations Involved	Description	National Co. Dwg. And Part Number
----------	---------------------	--	-------------	--

FUSES (CLASS 28)

1	F-201, 202	1 Amp. Glass Enclosed, *3AG	
---	-------	------------	-----------------------------	--

A.F. TRANSFORMERS AND INDUCTORS (CLASS 30)

1	CNA-30497	T-105	600/600 Ohm $\pm 10\%$ Audio Trans. Primary: 1340 Turns No. 29, D.C. Res. 40 Ohms $\pm 10\%$. Secondary: 1340 Turns (total) No. 29 C.T. D.C. Res. C.T. to Inside, 25 Ohms $\pm 10\%$. C.T. to Outside 30 Ohms $\pm 10\%$, *F-600A	C-285
1	CNA-30498	*T-201	110/120 Volt, 50/60 Cycle Power Trans. Primary: (Terminals 1 and 2) 600 Turns No. 24, D.C. Res. 8 Ohms $\pm 10\%$. $\frac{1}{2}$ H.V. Sec.: (Terminals 3 and 4) 1700 Turns No. 35, D.C. Res. 380 Ohms $\pm 10\%$. $\frac{1}{2}$ H.V. Sec.: (Terminals 4 and 5) 1700 Turns No. 35 D.C. Res. 420 Ohms $\pm 10\%$. V-201 Fil. Sec.: (Terminals 6 and 7) 28 Turns No. 17, D.C. Res. .12 Ohms $\pm 10\%$. Heater Sec.: (Terminals 8 and 9) 36 Turns No. 16, D.C. Res. .13 Ohms $\pm 10\%$. Shield: (Terminal G). *12069C.	C-301
1	CNA-30499	*T-201	110/120 Volt, 25 Cycle. Power Trans. Primary: (Terminals 1 and 2) 900 Turns No. 24, D.C. Res. 13 Ohms $\pm 10\%$. $\frac{1}{2}$ H.V. Sec.: (Termi-	C-301

* Manufacturer's Type.

1 Supplied only with Equipments utilizing the type CNA-20090 Power Unit.

2 Supplied only with Equipments utilizing the type CNA-20089 Power Unit.

MODEL RAS RADIO RECEIVING EQUIPMENT

15.4 TABLE III (Continued)

**SPARE PARTS LIST BY NAVY TYPE DESIGNATIONS
FOR MODEL RAS RADIO RECEIVING EQUIPMENT**

Quantity	Navy Type Desig.	All Symbol Designations Involved	Description	National Co. Dwg. And Part Number
A.F. TRANSFORMERS AND INDUCTORS (CLASS 30) (Continued)				
1	CNA-30500	L-201	nals 3 and 4) 2550 Turns No. 34. D.C. Res. 450 Ohms $\pm 10\%$. $\frac{1}{4}$ H.V. Sec.: (Terminals 4 and 5) 2550 Turns No. 34. D.C. Res. 500 Ohms $\pm 10\%$. V-201 Fil. Sec.: (Terminals 6 and 7) 45 Turns No. 16. D.C. Res. .15 Ohms $\pm 10\%$. Heater Sec.: (Terminals 8 and 9) 59 Turns No. 16 D.C. Res. .22 Ohms $\pm 10\%$. Shield: (Terminal G). *12360C.	C-327
1	CNA-30501	T-301	Inductor: 5000 Turns No. 31, D.C. Res. 300 Ohms $\pm 10\%$, 17 Henry $\pm 20\%$, .08 Amp. *J4373C. 5000/2.8 Ohm Audio Coupling Trans. Primary: (Terminals 1 and 2) 2300 Turns No. 36. D.C. Res. 275 Ohms $\pm 10\%$. Secondary: (Terminals 3 and 4) 52 Turns No. 19. D.C. Res. .16 Ohms $\pm 10\%$. *5537C.	C-295
VACUUM TUBES (CLASS 38)				
1	CRC-38593	V-201	Full Wave Rectifier. *5Z3	
3	CRC-38636	V-103, 104, 108	R.F. Pentode. *6CG	
4	CRC-38646	V-101, 102, 105, 106	R.F. Pentode. *6D6	
1	CRC-38768F	V-107	Dual Triode. *6F8G	
1	V-109	Beam Audio Output. *6V6G*	
R.F. TRANSFORMERS (CLASS 47)				
1	T-101, 102	175 KC. I.F. Trans. *1FC-88	
1	T-103	175 KC. C.W. Osc. Trans. *1FCO-2	
1	T-104	175 KC. I.F. Trans. *1FC-89	
CAPACITORS (CLASS 48)				
1	CAW-48286A	C-119	Paper: 1 mfd. $\pm 20\%$ - 10% , 400 V DC W. *461	
1	CAW-48690-10	C-140	Mica: .0025 mfd. $\pm 10\%$, 500 V DC W. *1468	
1	CAW-48848-10	C-110	Mica: .01 mfd. $\pm 10\%$, 300 V DC W *1467	
1	CAW-48854-3	C-406	Mica: .0003 mfd. $\pm 3\%$, 500 V DC W *1467	
<p>* Manufacturer's Type. # Assignment for REPLACEMENT USE ONLY. * 6V6GT may be substituted.</p>				

MODEL RAS RADIO RECEIVING EQUIPMENT

15.4 TABLE III (Continued)

SPARE PARTS LIST BY NAVY TYPE DESIGNATIONS
FOR MODEL RAS RADIO RECEIVING EQUIPMENT

Quantity	Navy Type Desig.	All Symbol Designations Involved	Description	National Co. Dwg. And Part Number
CAPACITORS (CLASS 48) (Continued)				
1	CAW-48983-3	C-1007	Mica: .001 mfd. $\pm 3\%$, 500 V DC W *1467	
2	CAW-48983-10	C-102, 124, 135	Mica: .001 mfd. $\pm 10\%$, 500 V DC W *1467	
1	CAW-481016-3	C-506	Mica: .0007 mfd. $\pm 3\%$, 500 V DC W *1467	
1	CAW-481037-10	C-103	Mica: .005 mfd. $\pm 10\%$, 300 V DC W *1467	
1	CAW-481042-10	C-109	Mica: .0003 mfd. $\pm 10\%$, 500 V DC W *1465	
1	CAW-481043-10	C-137	Mica: .0005 mfd. $\pm 10\%$, 500 V DC W *1467	
1	CD -481044	C-134	Electrolytic: 10 mfd., 50 V DC W *FA10025	
1	CD -481045	C-147	Electrolytic: 25 mfd., 50 V DC W *FA10062	
3	CAW-481072	C-107, 117, 123, 130, 142	Paper: .01 mfd. $\pm 20\%$ - 10% , 400 V DC W *489	
5	CAW-481073	C-104, 108, 113, 118, 125, 127, 129, 133, 141	Paper: .1 mfd. $\pm 20\%$ - 10% , 400 V DC W *489	
1	CAW-481074	C-138	Paper: .25 mfd. $\pm 20\%$ - 10% , 400 V DC W *489	
3	CAW-481075	C-105, 106, 111, 112, 114, 139	Paper: .1 mfd. $\pm 20\%$ - 10% , 600 V DC W *689	
2	CAW-481076	C-120, 136, 143	Paper: .25 mfd. $\pm 20\%$ - 10% , 600 V DC W *689	
1	CAW-481077-10	C-1003	Mica: .00004 mfd. $\pm 10\%$, 500 V DC W *1468	
2	CD -481080	C-208, 204, 205, 206	Paper: 4 mfd. 600 V DC W *TL-AD 6040	
1	CAW-481084-3	C-606, 1002	Mica: .0012 mfd. $\pm 3\%$, 500 V DC W *1467	
1	CAW-481085-3	C-705	Mica: .0026 mfd. $\pm 3\%$, 500 V DC W *1467	
1	CAW-481086-3	C-805	Mica: .0051 mfd. $\pm 3\%$, 300 V DC W *1467	
1	CAW-481087-3	C-905	Mica: .0088 mfd. $\pm 3\%$, 300 V DC W *1467	
1	C-128	Bakelite: 2 mmf. 400 V DC W *B22	
RESISTORS (CLASS 63)				
1	CBN-63288	R-133	50,000 Ohm, $\pm 10\%$, 1 Watt *314	
1	CBN-63360	R-129	250 Ohm, $\pm 10\%$, $\frac{1}{2}$ Watt *310	
2	CBN-63360	R-102, 104, 114, 138	300 Ohm, $\pm 10\%$, $\frac{1}{2}$ Watt *310	
1	CBN-63360	R-125	1,500 Ohm, $\pm 10\%$, $\frac{1}{2}$ Watt *310	
1	CBN-63360	R-111, 118	2,000 Ohm, $\pm 10\%$, $\frac{1}{2}$ Watt *310	
1	CBN-63360	R-106, 110	5,000 Ohm, $\pm 10\%$, $\frac{1}{2}$ Watt *310	

* Manufacturer's Type.

MODEL RAS RADIO RECEIVING EQUIPMENT

15.4 TABLE III (Continued)

SPARE PARTS LIST BY NAVY TYPE DESIGNATIONS
FOR MODEL RAS RADIO RECEIVING EQUIPMENT

Quantity	Navy Type Desig.	All Symbol Designations Involved	Description	National Co. Dwg. And Part Number
RESISTORS (CLASS 63) (Continued)				
1	CBN-63360	R-135	10,000 Ohm, $\pm 10\%$, $\frac{1}{2}$ Watt *310	
2	CBN-63360	R-105, 132, 134	20,000 Ohm, $\pm 10\%$, $\frac{1}{2}$ Watt *310	
1	CBN-63360	R-108	25,000 Ohm, $\pm 10\%$, $\frac{1}{2}$ Watt *310	
3	CBN-63360	R-107, 109, 120, 121, 127	100,000 Ohm, $\pm 10\%$, $\frac{1}{2}$ Watt *310	
1	CBN-63360	R-122	250,000 Ohm, $\pm 10\%$, $\frac{1}{2}$ Watt *310	
3	CBN-63360	R-101, 103, 112, 123, 126, 128	500,000 Ohm, $\pm 10\%$, $\frac{1}{2}$ Watt *310	
1	CBN-63474	R-137	250 Ohm, $\pm 10\%$, 2 Watt *316	
1	CBN-63474	R-130, 131	1,000 Ohm, $\pm 10\%$, 2 Watt *316	
1	CBN-63474	R-117	15,000 Ohm, $\pm 10\%$, 2 Watt *316	
1	CBN-63474	R-116	30,000 Ohm, $\pm 10\%$, 2 Watt *316	
1	CYM-63751	R-139	64 Ohm, C.T., 3 Watt *864C	
1	CMC-63756	R-115	10,000 Ohm, 1.5 Watt, W.W. Var. *P58-10,000U	
1	CBN-63757	R-136	500,000 Ohm, 1 Watt, Comp. Var. *72-105	
<p>Prefix letters on items indicate the exact types <i>originally</i> furnished as spare parts. Replacements of these spares need not carry same prefix letters. * Manufacturer's Type.</p>				

RMA COLOR CODE FOR RESISTORS

Color	Body	End	Dot
Black	—	0	.0
Brown	1	1	0
Red	2	2	00
Orange	3	3	000
Yellow	4	4	0000
Green	5	5	00000
Blue	6	6	000000
Purple	7	7	0000000
Gray	8	8	00000000
White	9	9	—

Body color denotes first numeral in resistance value.
 End color denotes second numeral.
 Dot color denotes number of ciphers following first two numerals.
 Gold color bronze end dip indicates 5% tolerance.
 Silver color bronze end dip indicates 10% tolerance.
 Other resistors 20% tolerance.

MODEL RAS RADIO RECEIVING EQUIPMENT

15.5 LIST OF MANUFACTURERS

CODE No.	MFR. PREFIX	NAME	ADDRESS
1	CAW	Aerovox Corporation	New Bedford, Mass.
2	CBN	Central Radio Labs.	Milwaukee, Wisconsin
3	CD	Cornell Dubilier Elec. Corp.	So. Plainfield, N. J.
4	CG	General Electric (Mazda)	Cleveland, Ohio
5	CHII	Arrow-Hart & Hegeman	Hartford, Conn.
6	CLF	Littelfuse Laboratories	Chicago, Illinois
7	CMC	Clarostat Mfg. Co., Inc.	Brooklyn, N. Y.
8	CNA	National Company, Inc.	Malden, Mass.
9	CRC	RCA Manufacturing Company	Harrison, N. J.
		RCA Radiotron Division	
10	CYM	Yaxley Division of	Indianapolis, Ind.
		P. R. Mallory & Co., Inc.	
11		The Rola Co., Inc.	Cleveland, Ohio
12		Cinch Mfg. Co.	Chicago, Illinois
13		Cornish Wire Company	New York, N. Y.
14		P. & F. Corbin	New Britain, Conn.

MODEL RAS RADIO RECEIVING EQUIPMENT

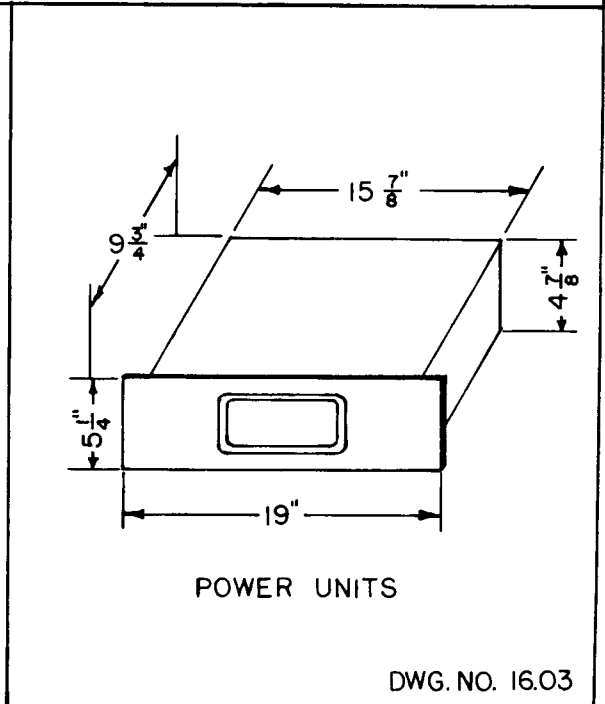
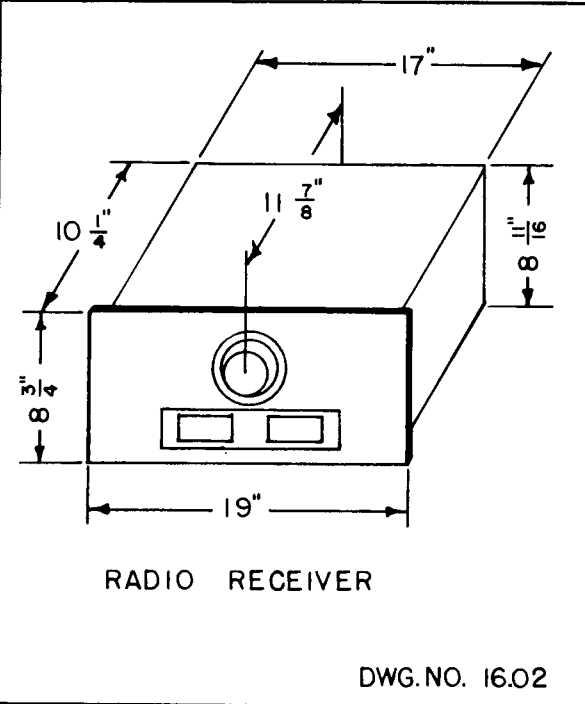
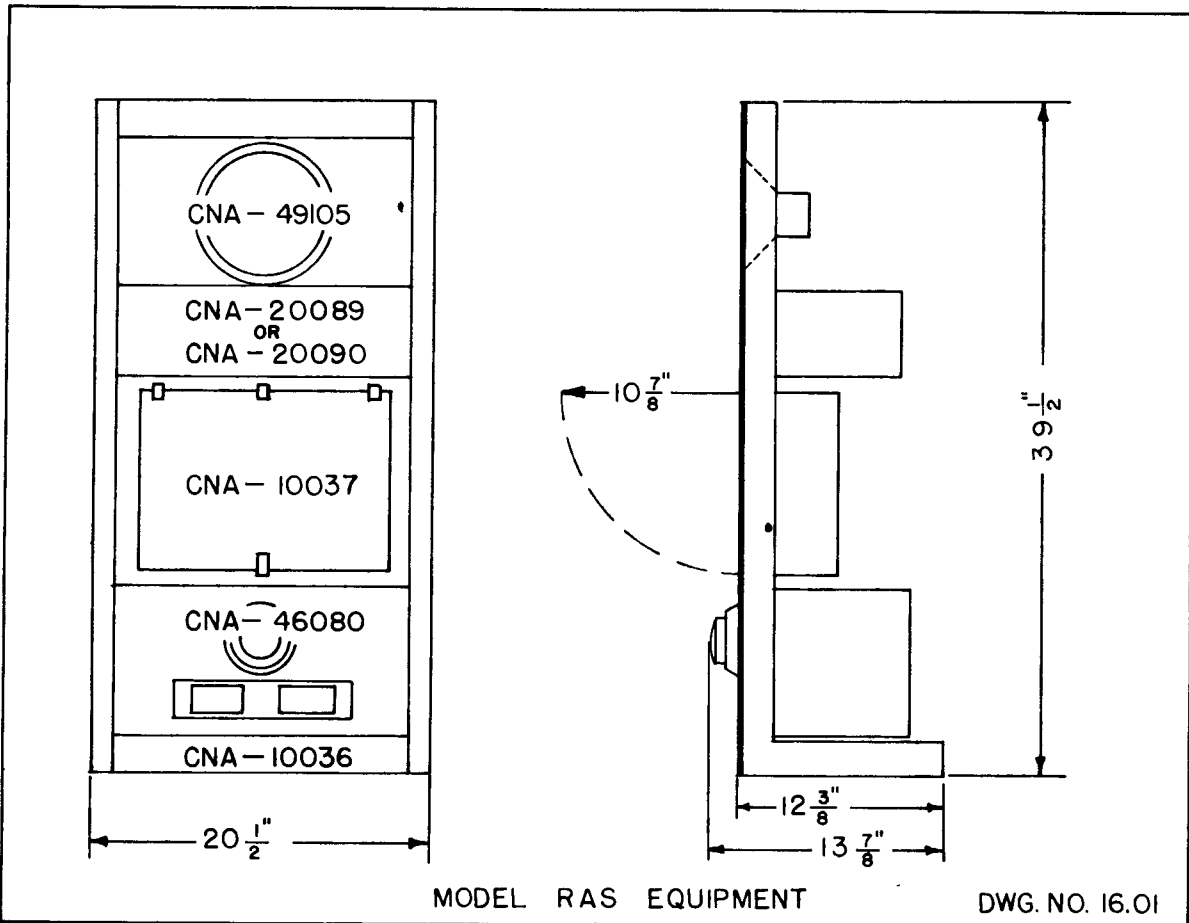

OUTLINE DRAWINGS

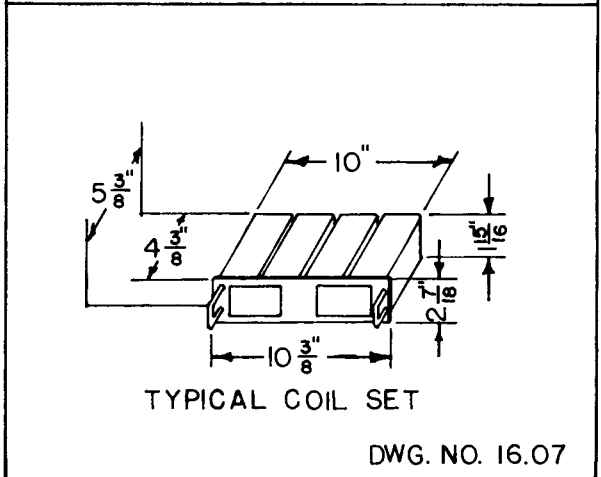
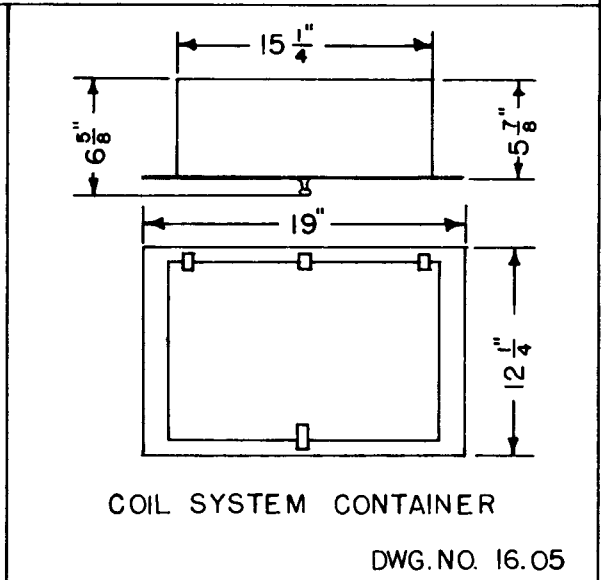
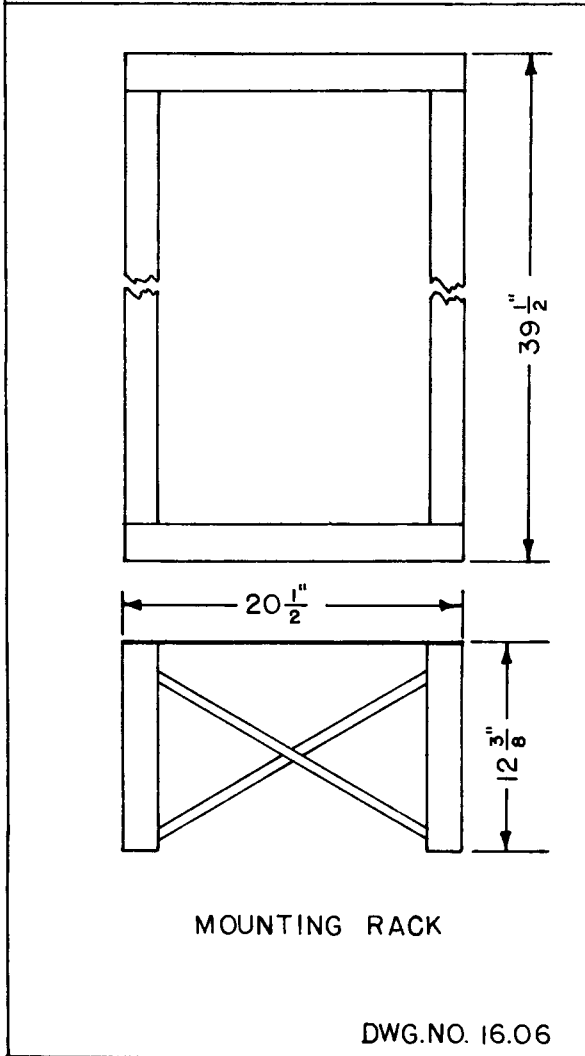
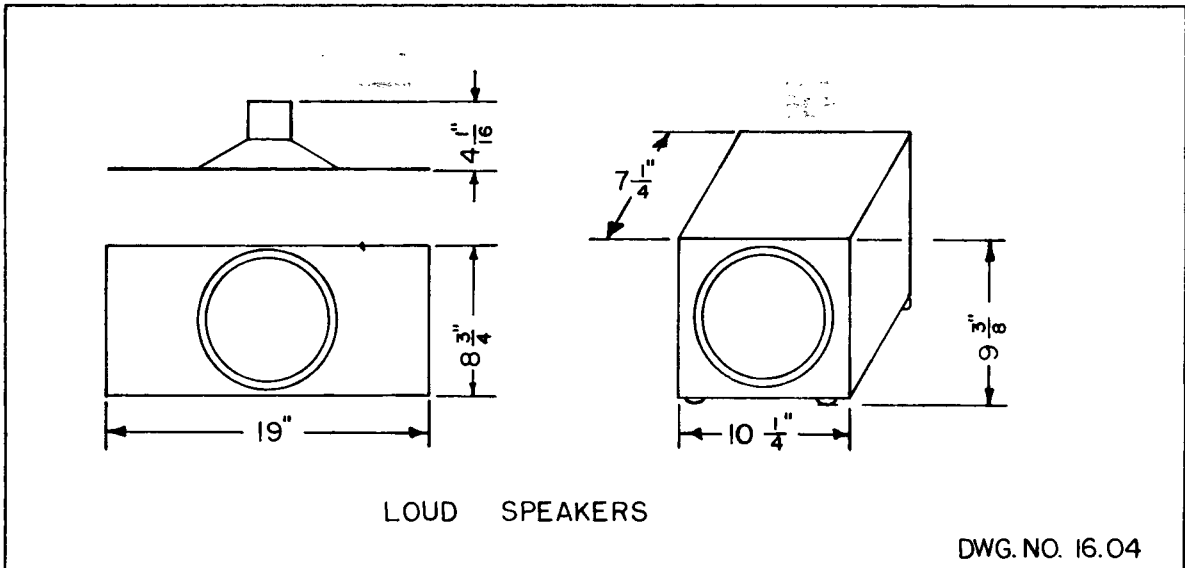

MODEL RAS RADIO RECEIVING EQUIPMENT

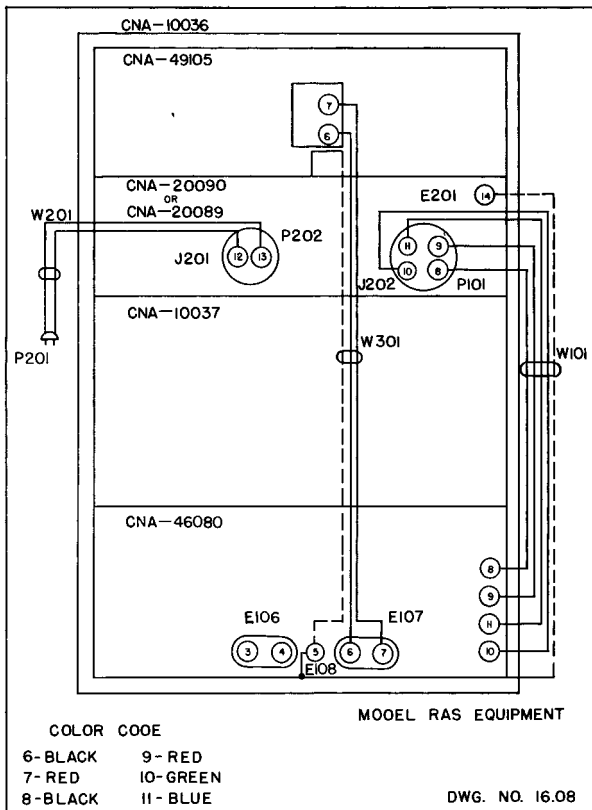

EXTERNAL WIRING CONNECTIONS

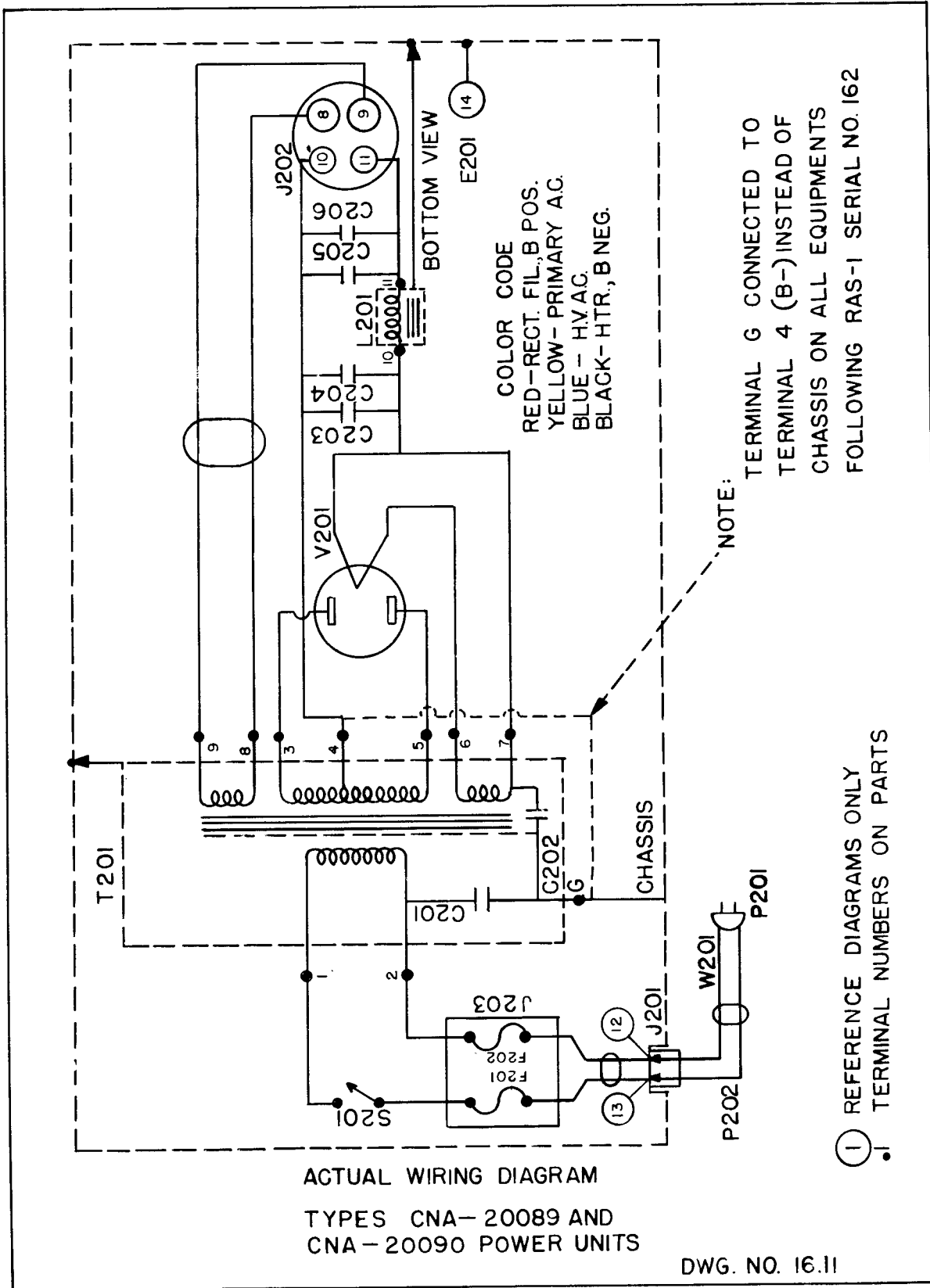

MODEL RAS RADIO RECEIVING EQUIPMENT

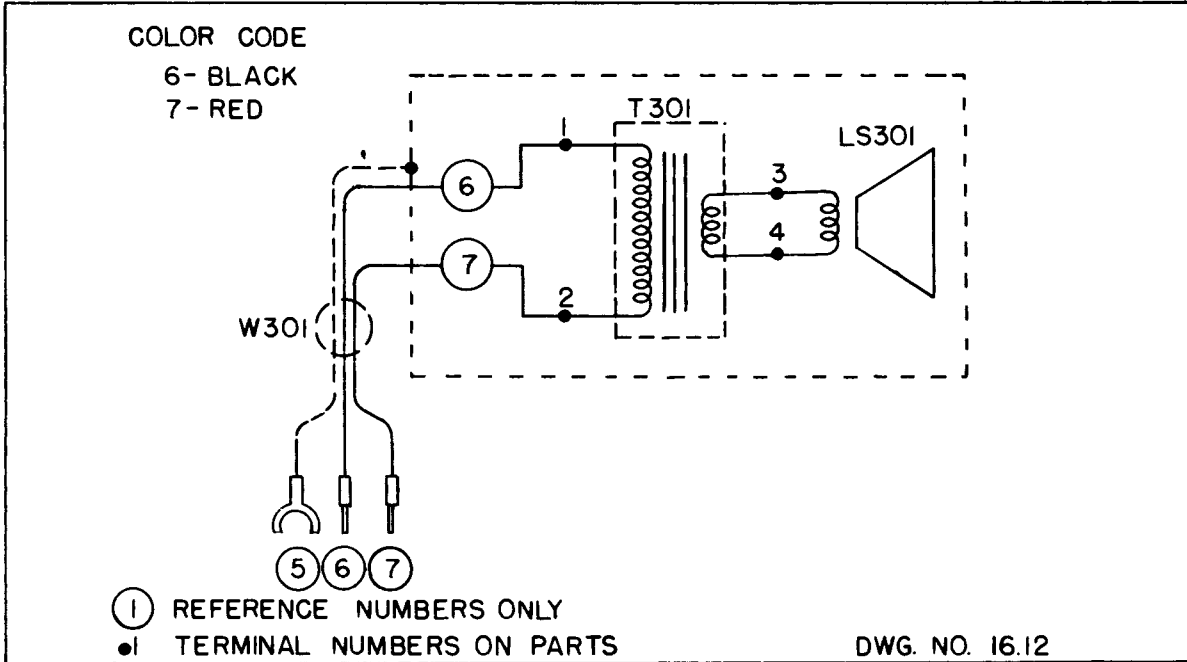

ACTUAL WIRING DIAGRAM
TYPES CNA-49105 AND CNA-49106
LOUD SPEAKER UNITS

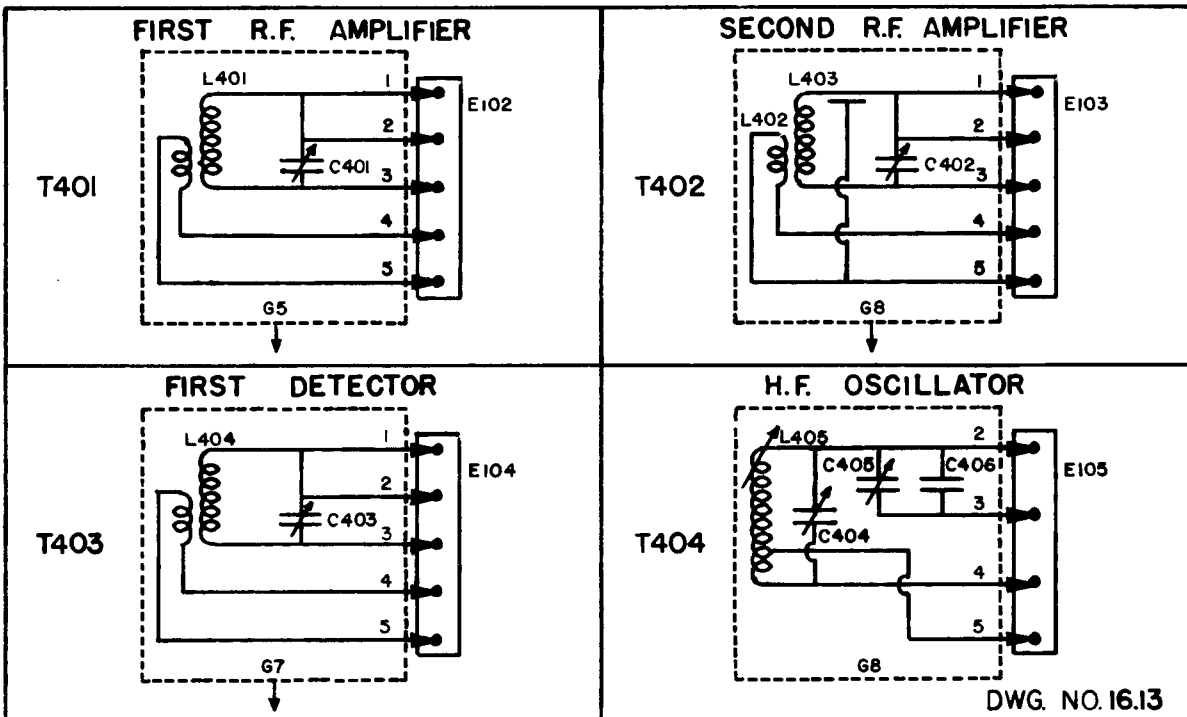

ACTUAL WIRING DIAGRAM
TYPE CNA-47156 COIL SET I

MODEL RAS RADIO RECEIVING EQUIPMENT

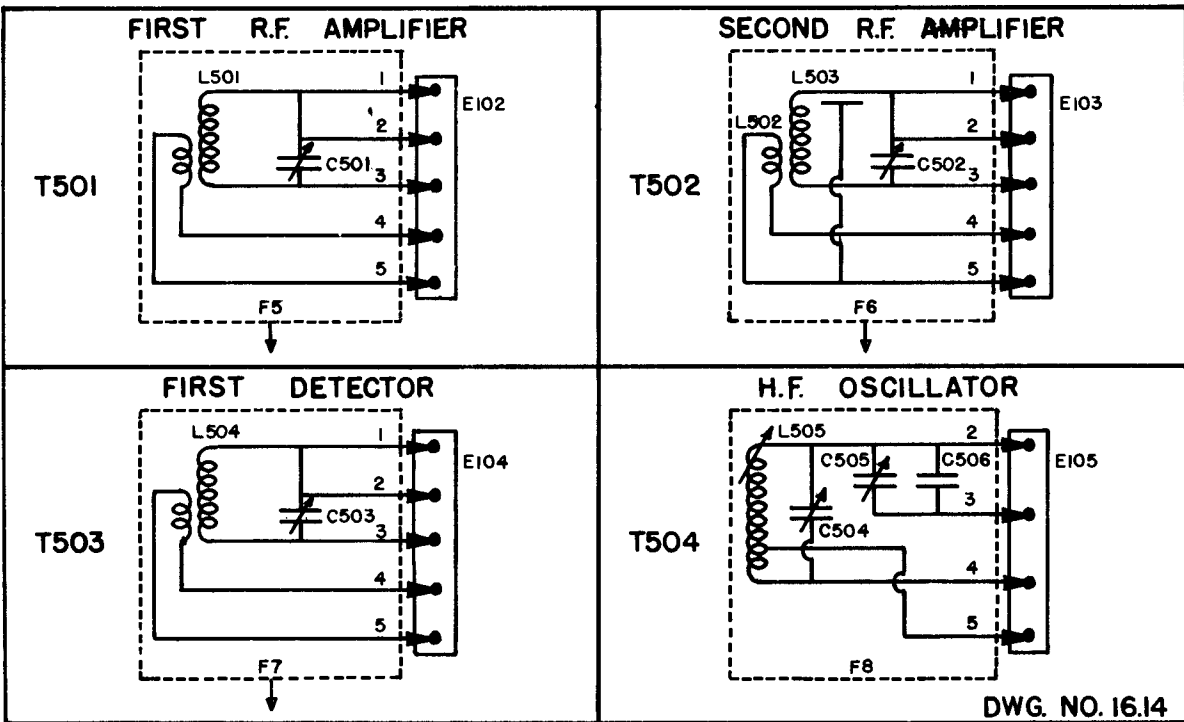

ACTUAL WIRING DIAGRAM
TYPE CNA-47157 COIL SET 2

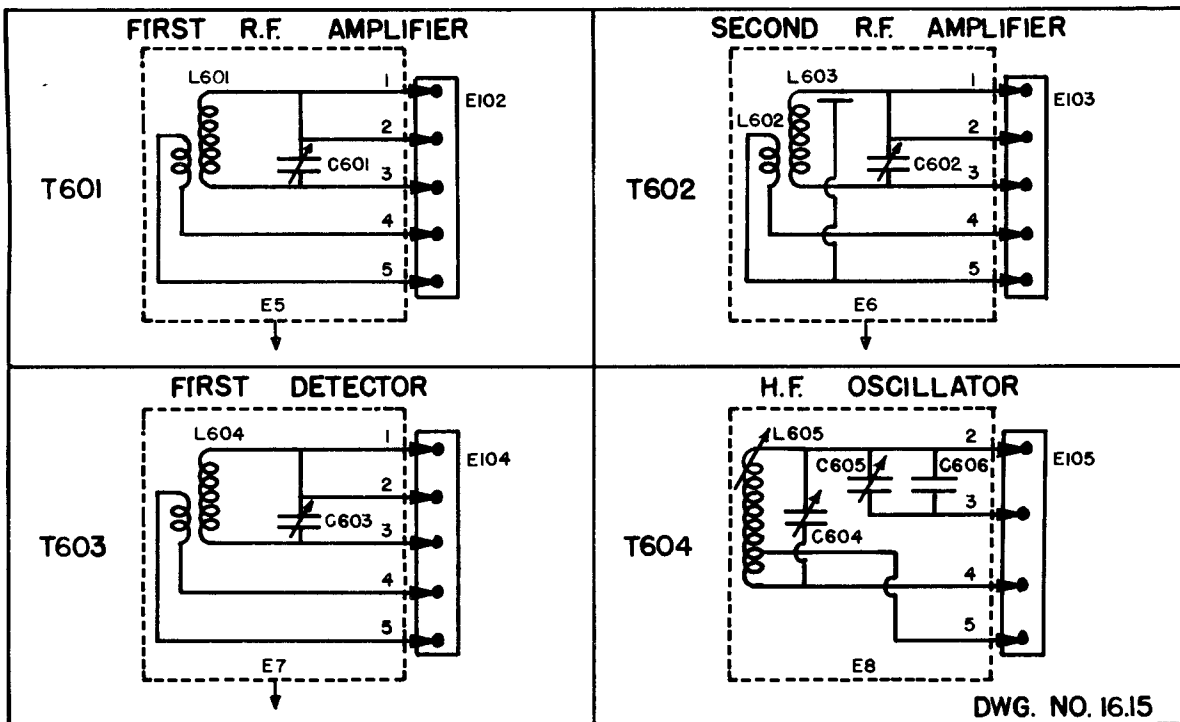

ACTUAL WIRING DIAGRAM
TYPE CNA-47158 COIL SET 3

MODEL RAS RADIO RECEIVING EQUIPMENT

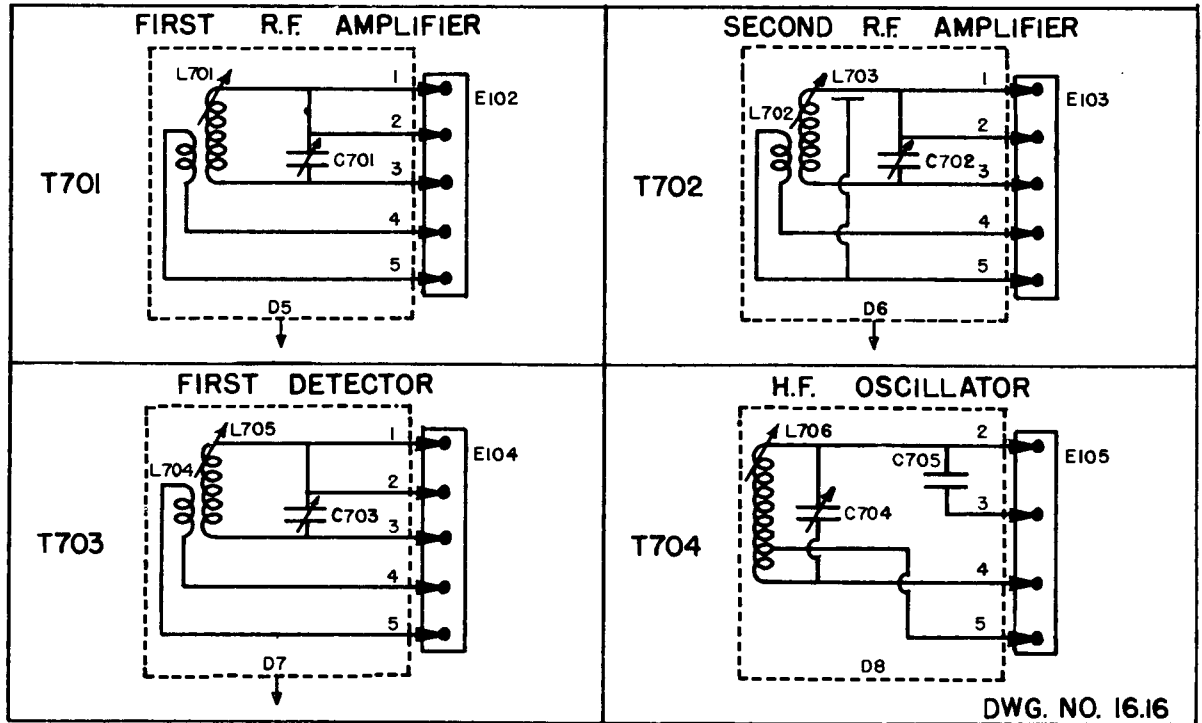

ACTUAL WIRING DIAGRAM
TYPE CNA-47159 COIL SET 4

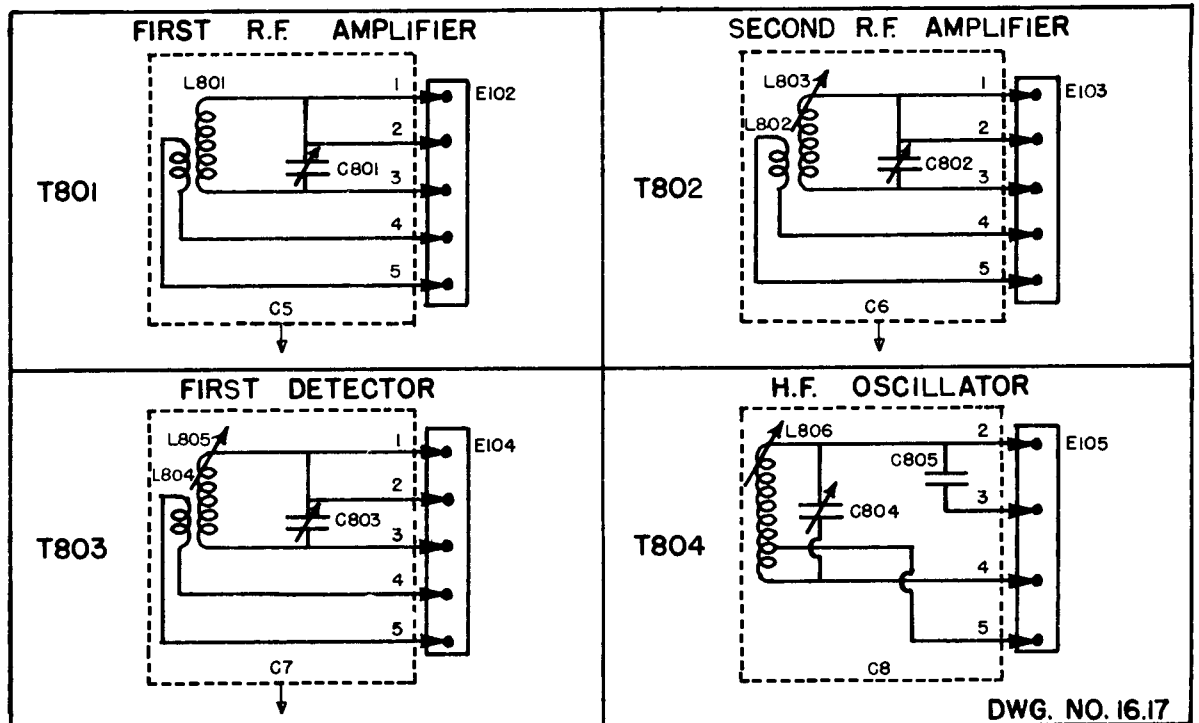

ACTUAL WIRING DIAGRAM
TYPE CNA-47160 COIL SET 5

MODEL RAS RADIO RECEIVING EQUIPMENT

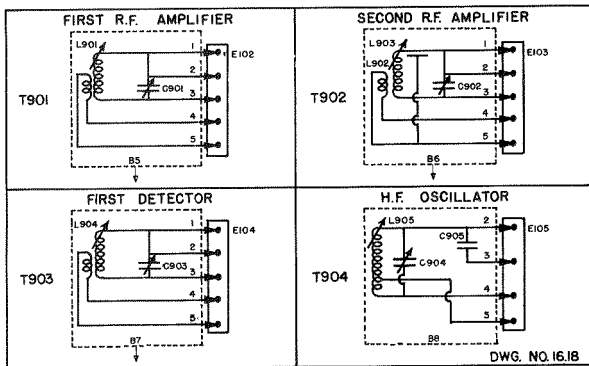

ACTUAL WIRING DIAGRAM
TYPE CNA-47161 COIL SET 6

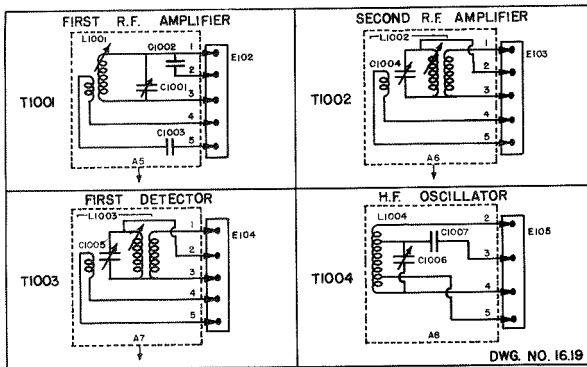

ACTUAL WIRING DIAGRAM
TYPE CNA-47162 COIL SET 7

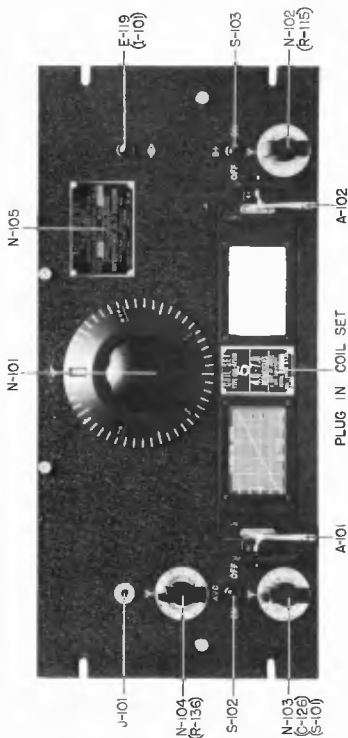

PHOTO NO. 17.01 FRONT VIEW OF RADIO RECEIVER

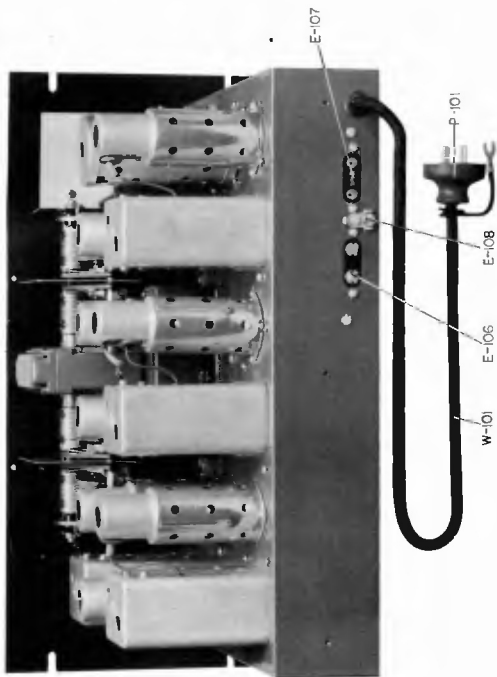

PHOTO NO. 17.02 REAR VIEW OF RADIO RECEIVER

MODEL RAS RADIO RECEIVING EQUIPMENT

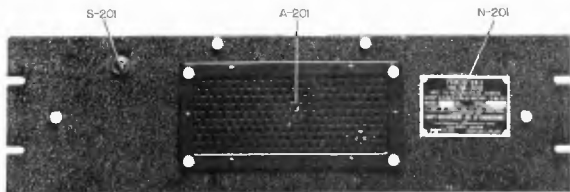

PHOTO NO. 17.03 FRONT VIEW OF POWER UNIT

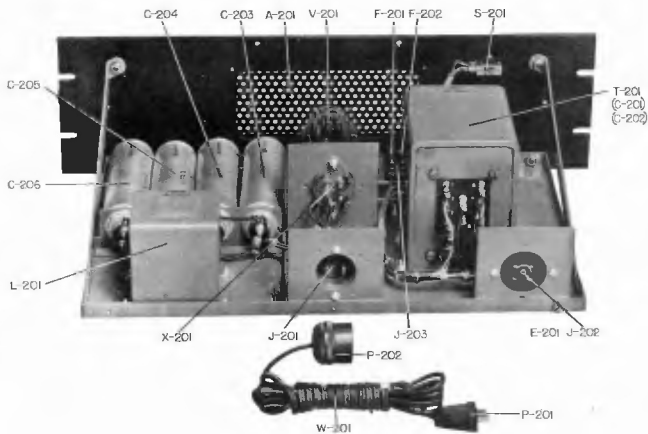

PHOTO NO. 17.04 INTERNAL VIEW OF POWER UNIT

MODEL RAS RADIO RECEIVING EQUIPMENT

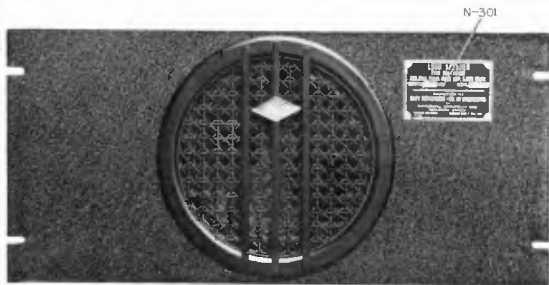

PHOTO NO. 17.05 FRONT VIEW OF LOUD SPEAKER

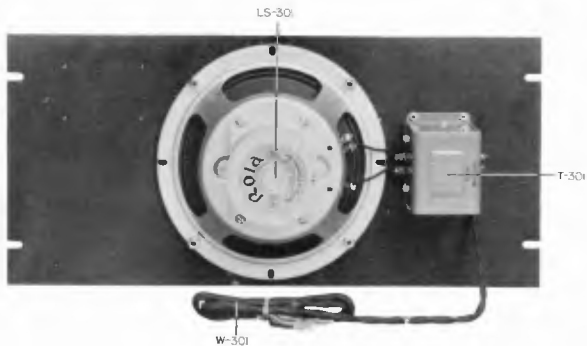

PHOTO NO. 17.06 REAR VIEW OF LOUD SPEAKER

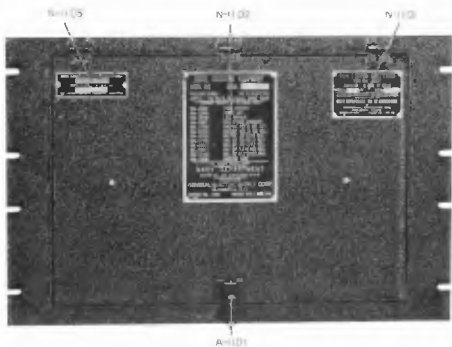

PHOTO NO. 17.07 FRONT VIEW OF COIL CONTAINER

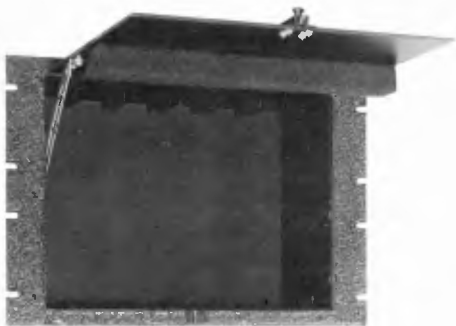

PHOTO NO. 17.08 INTERNAL VIEW OF COIL CONTAINER

MODEL RAS RADIO RECEIVING EQUIPMENT

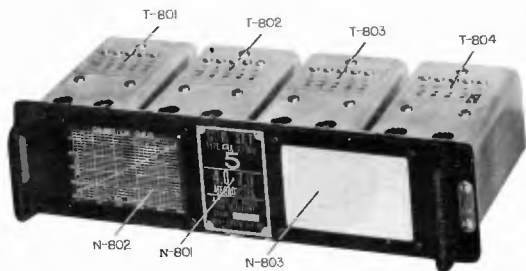

PHOTO NO. 17.09 TYPICAL COIL SET (SET NO. 5)

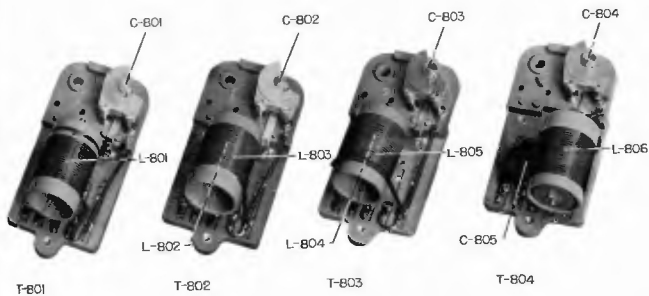
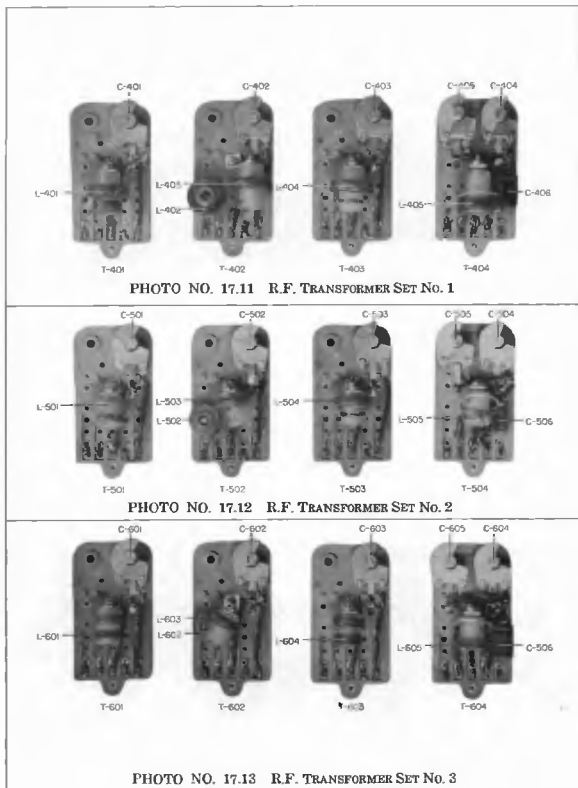

PHOTO NO. 17.10 R.F. TRANSFORMER SET NO. 5



INTERNAL VIEWS

MODEL RAS RADIO RECEIVING EQUIPMENT



PHOTO NO. 17.14 R.F. TRANSFORMER SET No. 4

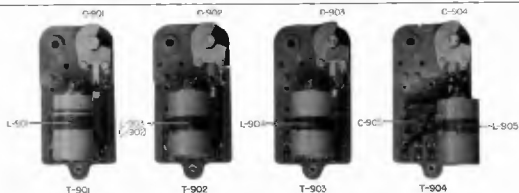

PHOTO NO. 17.15 R.F. TRANSFORMER SET No. 6

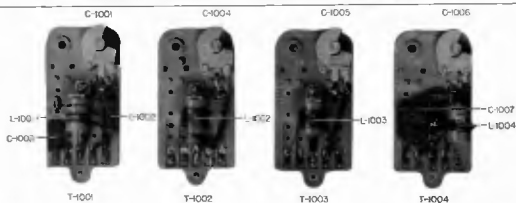

PHOTO NO. 17.16 R.F. TRANSFORMER SET No. 7

INTERNAL VIEWS

MODEL RAS RADIO RECEIVING EQUIPMENT

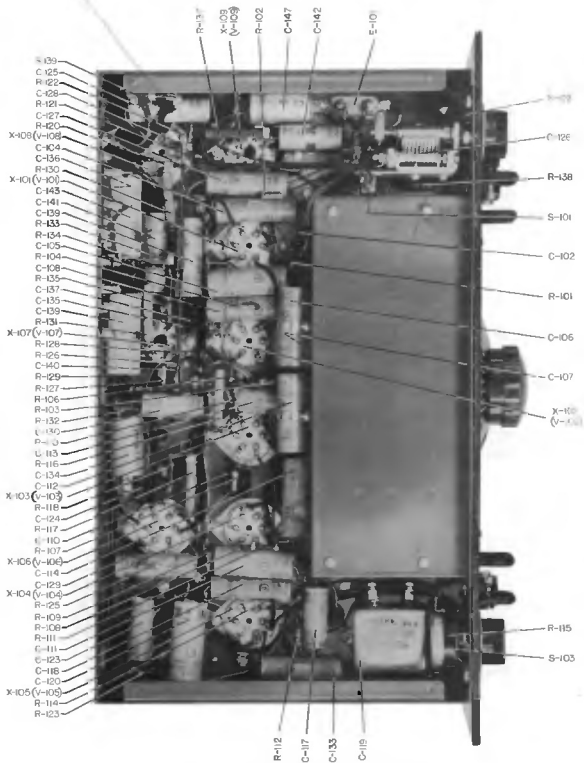

PHOTO NO. 17.17 BOTTOM VIEW OF RADIO RECEIVER

MODEL RAS RADIO RECEIVING EQUIPMENT

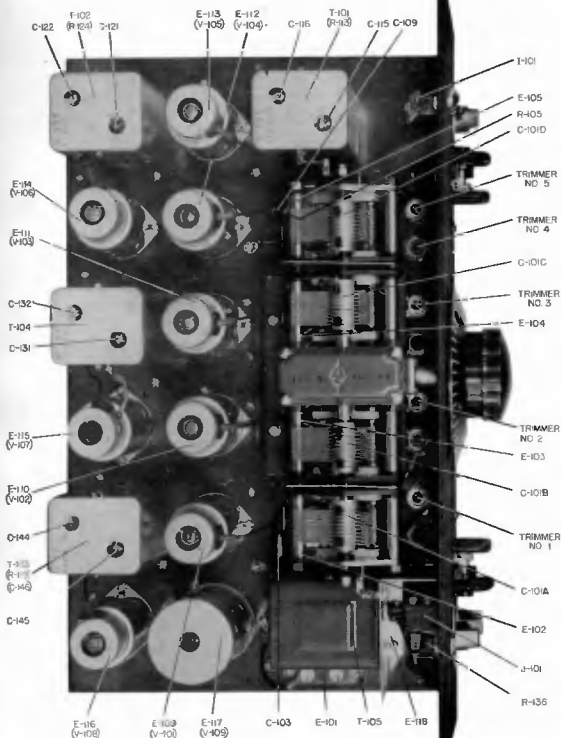

PHOTO NO. 17.18 TOP VIEW OF RADIO RECEIVER

**PHOTOGRAPHS
OF
AUXILIARY UNITS
Type CNA-20089 Power Unit
and
Type CNA-49106 Loud Speaker Unit**

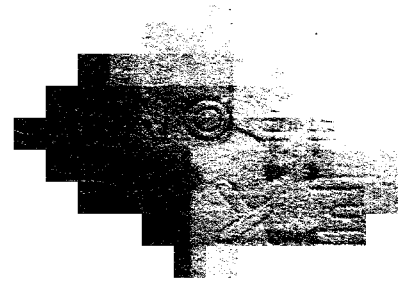



PHOTO NO. 17.19 FRONT VIEW OF LOUD SPEAKER

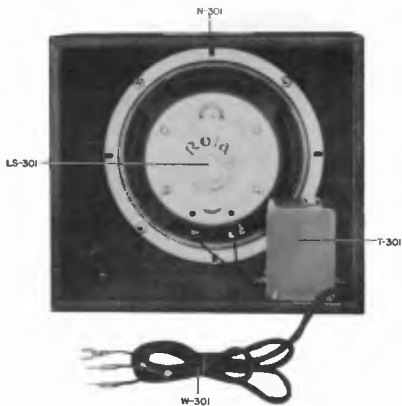

PHOTO NO. 17.20 REAR VIEW OF LOUD SPEAKER

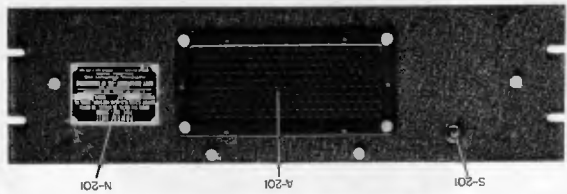

PHOTO NO. 1721 FRONT VIEW OF POWER UNIT

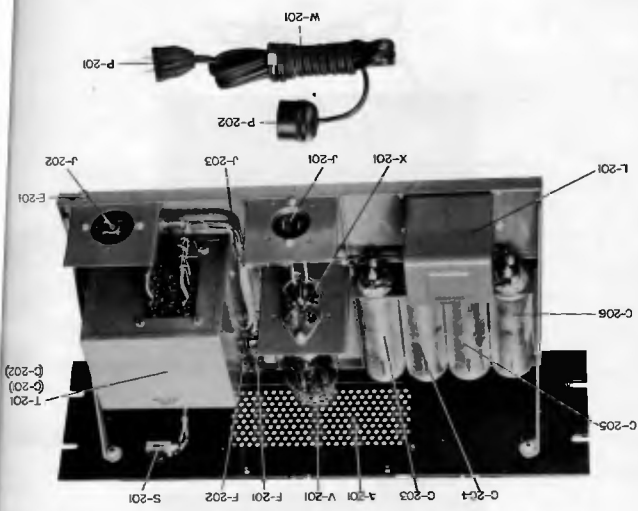
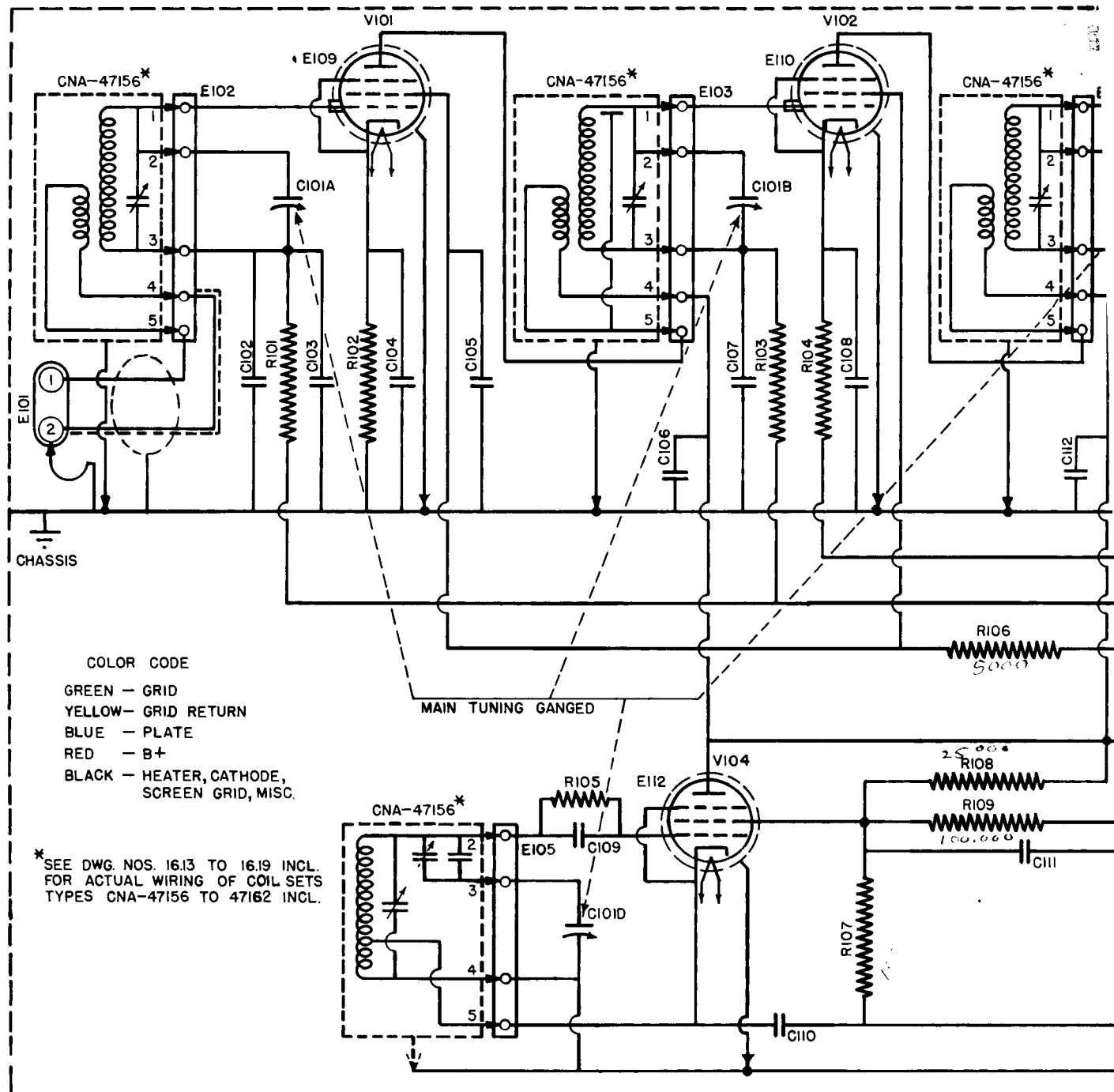
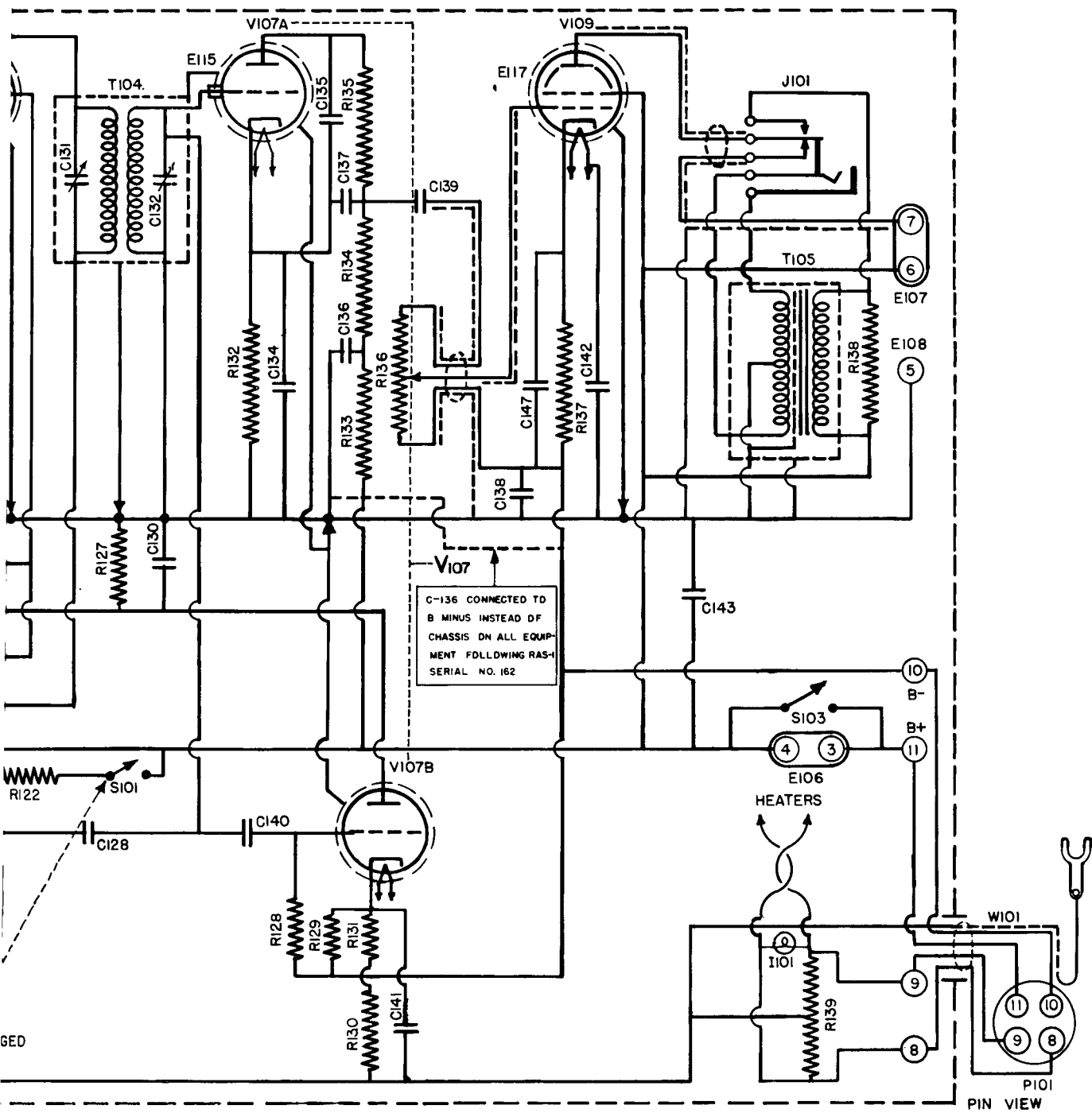

PHOTO NO. 1722 INTERNAL VIEW OF POWER UNIT



① REFERENCE NUMBERS ONLY
1 TERMINAL NUMBERS ON PARTS



**TYPE CNA-46080 RADIO
 RECEIVER DWG. NO. 16.10**

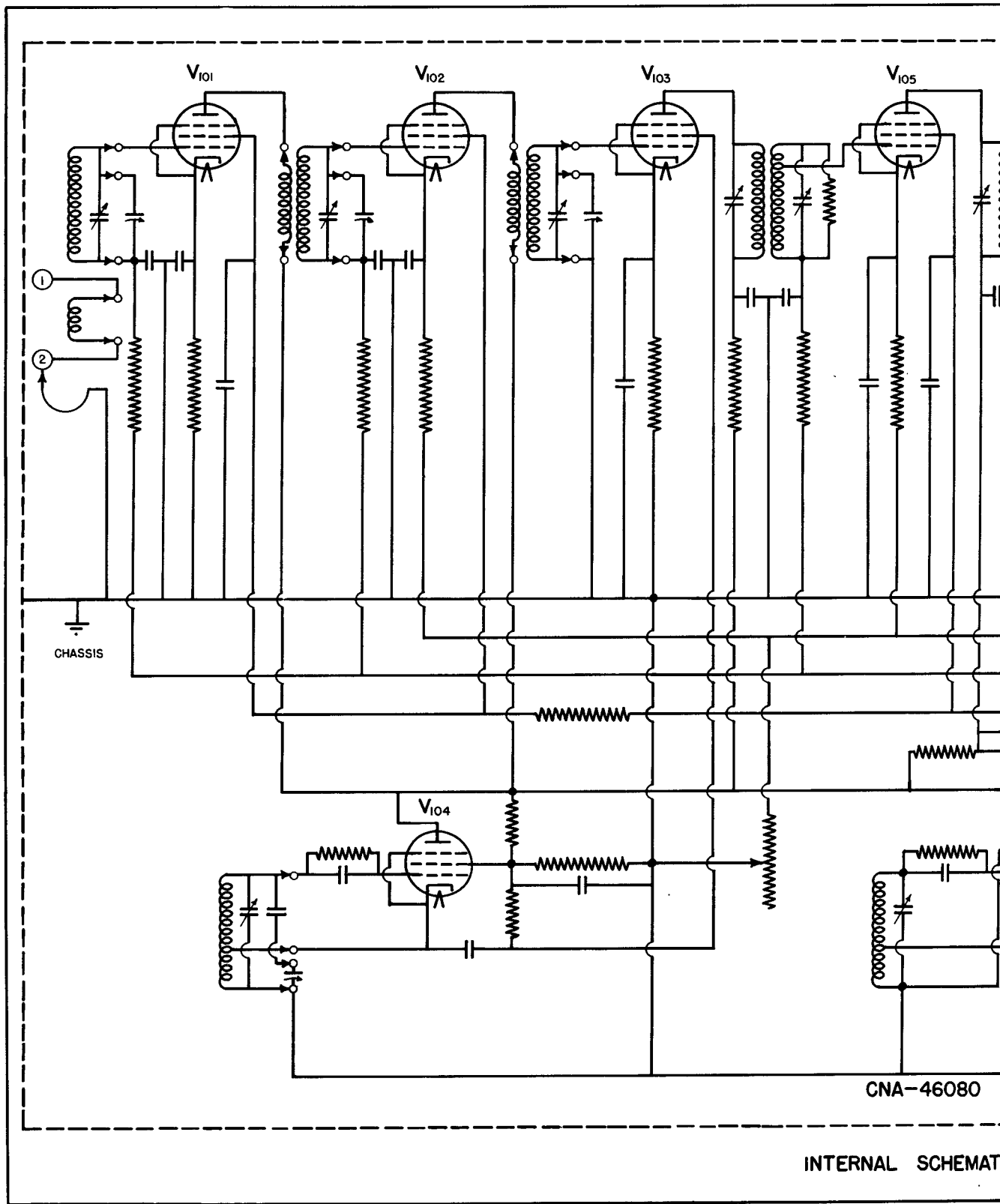

CNA-46080

INTERNAL SCHEMAT

① REFERENCE NUMBERS ONLY

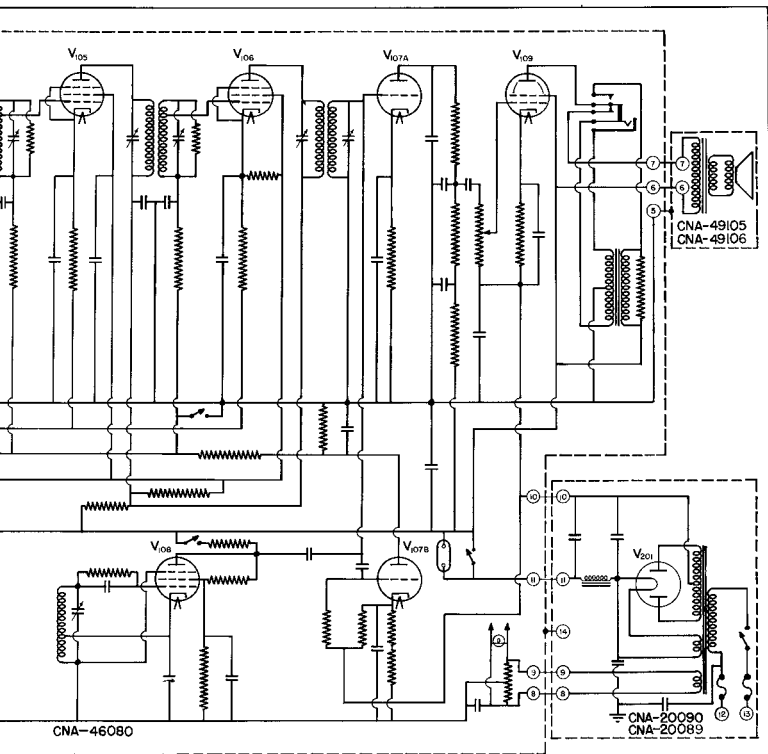

INTERNAL SCHEMATIC DIAGRAM

MODEL RAS EQUIPMENT
DWG. NO. 16.09