

RADIO TELETYPEWRITER SET AN/GRC-46

1 July 1958

Cognizant Serv: USA FSN:

USA

USN

USAF

TYPE CLASS: Std
 STOCK NO: 2S2501-46

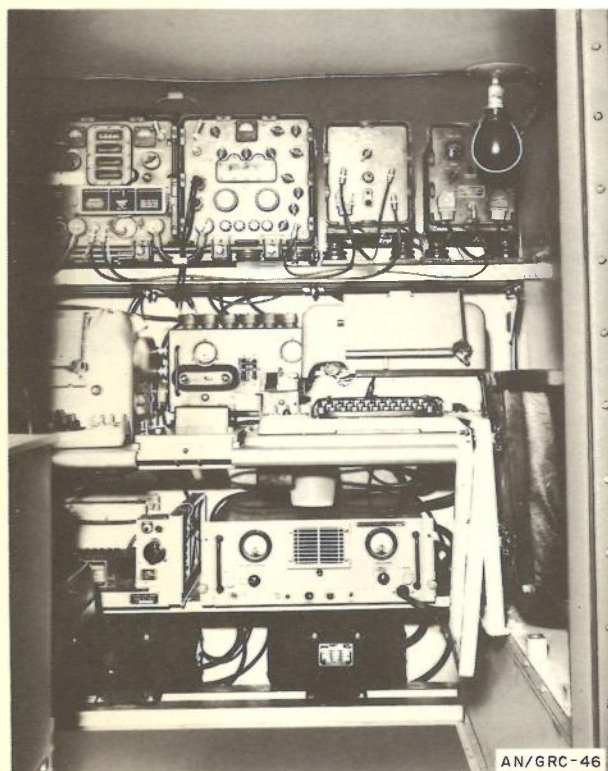

FUNCTIONAL DESCRIPTION:

Radio Teletypewriter Set AN/GRC-46 is an assembly of transmitting, receiving, and teletypewriter equipment arranged in a shelter and mounted on a vehicle. It is a complete mobile radioteletype station.

This set can provide either separate or simultaneous transmission and reception of voice and radioteletype signals. It may be operated while the vehicle is in motion.

TECHNICAL CHARACTERISTICS:

Frequency Range in Mc:

Transmitter: 1.5 to 20.0

Receiver: 1.5 to 32.0

Type Modulation: AM

Type of Signal: Cw, voice, fsk radioteletype

Power Output: 100 w

Power Requirements: 1,500 w, 28-v dc

MAJOR COMPONENTS

QTY	ITEM	STOCK NUMBERS	DIMENSIONS (Inches)	WEIGHT (Lbs)
(USA)				
1	Frequency Shift Converter CV-278/GR	2C722-278	13 x 7-1/4 x 9	
1	Interconnecting Box J-668			
1	Radio Modulator MD-203/GR	2C2537-203	13 x 7-1/4 x 9	
1	Radio Receiver R-392/URR	2C4180-392	11-1/2 x 14-1/8 x 11	52
1	Radio Transmitter T-195/ GRC-19			
1	Shelter S-89/G			
1	Teletypewriter T-98/FG	4TTT98.1		

MIL-HDBK-161

AN/GRC-46 RADIO TELETYPEWRITER SET

REFERENCE DATA AND LITERATURE:

TB SIG 302
TM 11-656-10
TM 11-656-25

SHIPPING DATA

PKGS	VOLUME (Cu Ft)	WEIGHT (Lbs)
------	----------------	--------------

(Set is assembled from individual components at Army Signal Depot, and is shipped in its Shelter S-89. No shipment packaging is required.)

PROCUREMENT DATA

PROCURING SERVICE: USA
SPEC &/or DWG: Depot assembled

DESIGN COG: USA, Sig C

CONTRACTOR	LOCATION	CONTRACT OR ORDER NO.	APPROX UNIT COST
------------	----------	-----------------------	------------------

RADIO SET **AN/GRC-48**

26 November 1958

Cognizant Serv: USN FSN: 5820-566-5539

USA

USN

USAF

TYPE CLASS: --

Used by

--

STOCK NO: --

--

--

(No Illustration Available)

FUNCTIONAL DESCRIPTION:

Radio Set AN/GRC-48 is a general purpose two-way communication set designed for fixed ground installation. It provides ground-to-ground and ground-to-air communications, utilizing ultra-high-frequency equipment.

This equipment is intended for communication with other field units and aircraft having similar radio sets operating in the identical band.

TECHNICAL CHARACTERISTICS:*Frequency Range in Mc:* 225 to 399.9*Frequency Control:* Crystal*Type Modulation:* AM, voice or mcw*Number of Preset Channels:* 10*Number of Channels Available:* 1,750; spaced at 100 kc intervals*Type Receiver:* Triple-conversion superheterodyne with automatic tuning*Receiver Sensitivity:* 1.0 w output at not less than 10 db signal-to-noise ratio*Receiver Input Impedance:* 52 ohms*Power Output:* 100 w*Power Requirements:* 115/230-v 50-60-cycle 1-phase ac**MAJOR COMPONENTS**

QTY	ITEM	STOCK NUMBERS	DIMENSIONS (Inches)	WEIGHT (Lbs)
1	Control, Radio Set C-1335/ TRC-32	(USA) 2C684A-1335		
1	Control, Radio Set C-1336/ TRC-32	(USA) 2C684-1336		
3	Headsets MHS-11	(FSN) 5965-281-0316		
1	Mast AB-155A/U	(FSN) 5985-251-2366		
3	Microphones, Carbon 51004C	(FSN) 5965-669-8804		
1	Modulator-Power Supply MD-129A/GR	(USA) 3H4497-129	12-7/32 x 19 x 22-11/16	
1	Radio Receiver R-278B/GR	(FSN) 5820-665-1971	21 x 19 x 12-1/4	
1	Radio Transmitter T-217A/GR	(FSN) 5820-642-7772	22 x 19 x 12-1/4	

REFERENCE DATA AND LITERATURE:

NAVMC ELEC-2003,
NAVSHIPS 91338,
TO 16-35C1335-1, -4,
TO 16-350A104-3, -4,
TO 16-350A192-3, -4

MIL-HDBK-161

AN/GRC-48 RADIO SET

SHIPPING DATA

PKGS	VOLUME (Cu Ft)	WEIGHT (Lbs)
------	----------------	--------------

PROCUREMENT DATA

PROCURING SERVICE: USN
SPEC &/or DWG:

DESIGN COG: USN, BuAer

CONTRACTOR	LOCATION	CONTRACT OR ORDER NO.	APPROX UNIT COST
------------	----------	--------------------------	---------------------

RADIO SET **AN/GRC-75**

26 November 1958

Cognizant Serv: USN FSN:

USA

USN

USAF

TYPE CLASS: --

Used by

--

STOCK NO: --

--

--

(No Illustration Available)

FUNCTIONAL DESCRIPTION:

Radio Set AN/GRC-75 is a transportable very-high-frequency transmitting and receiving equipment. It is designed primarily for use with multichannel carrier telephone terminal apparatus.

*Number of Bands: 1**Number of Channels: 200**Type Emission: FM**Power Output: 120 w***TECHNICAL CHARACTERISTICS:***Frequency Range: 50 mc to 100 mc**Power Requirements: 115-v 50-cycle 1-phase ac or 230-v 60-cycle 1-phase ac***MAJOR COMPONENTS**

QTY	ITEM	STOCK NUMBERS	DIMENSIONS (Inches)	WEIGHT (Lbs)
1	Radio Set AN/GRC-75 (Equipment consists of only one major component.)			

REFERENCE DATA AND LITERATURE:**SHIPPING DATA**

PKGS	VOLUME (Cu Ft)	WEIGHT (Lbs)

MIL-HDBK-161

AN/GRC-75 RADIO SET

PROCUREMENT DATA

PROCURING SERVICE: USN
SPEC &/or DWG:

DESIGN COG: USN

CONTRACTOR	LOCATION	CONTRACT OR ORDER NO.	APPROX UNIT COST
------------	----------	--------------------------	---------------------

RADIO TERMINAL SET **AN/GRC-76**

26 November 1958

Cognizant Serv: USN FSN:

USA

USN

USAF

TYPE CLASS: --

Used by

--

STOCK NO: --

--

--

(No Illustration Available)

FUNCTIONAL DESCRIPTION:

Radio Terminal Set AN/GRC-76 receives and transmits multichannel voice (12 voice plus 1 order wire), telegraph, teletypewriter and/or facsimile in conjunction with appropriate multichannel subcarrier telephone carrier equipment.

TECHNICAL CHARACTERISTICS:

Frequency Range in Mc: 50 to 100

Power Requirements: 115-v 60-cycle 1-phase ac

MAJOR COMPONENTS

QTY	ITEM	STOCK NUMBERS	DIMENSIONS (Inches)	WEIGHT (Lbs)
1	Radio Terminal Set AN/ GRC-76 (Equipment consists of only one major equipment.)			

REFERENCE DATA AND LITERATURE:**SHIPPING DATA**

PKGS	VOLUME (Cu Ft)	WEIGHT (Lbs)

MIL-HDBK-161

AN/GRC-76 RADIO TERMINAL SET

PROCUREMENT DATA

PROCURING SERVICE: USN
SPEC &/or DWG:

DESIGN COG: USN

CONTRACTOR	LOCATION	CONTRACT OR ORDER NO.	APPROX UNIT COST
------------	----------	--------------------------	---------------------

RADIO REPEATER SET **AN/GRC-77**

26 November 1958

Cognizant Serv: USN FSN:

USA

USN

USAF

TYPE CLASS: --

Used by --

STOCK NO: --

(No Illustration Available)

FUNCTIONAL DESCRIPTION:

Radio Repeater Set AN/GRC-77 receives and retransmits multichannel voice (12 voice plus 1 order wire), telegraph, teletypewriter and/or facsimile and provides a simultaneous two-way radio relay circuit.

TECHNICAL CHARACTERISTICS:

Frequency Range in Mc: 50 to 100*Number of Bands:* 1*Number of Channels:* 200*Method Operation:* Continuous multiplexing*Type Emission:* FM*Power Requirements:* 115-v 50-cycle 1-phase ac or 230-v 60-cycle 1-phase ac

MAJOR COMPONENTS

QTY	ITEM	STOCK NUMBERS	DIMENSIONS (Inches)	WEIGHT (Lbs)
1	Radio Repeater Set AN/ GRC-77 (Equipment consists of only one major component.)			

REFERENCE DATA AND LITERATURE:

SHIPPING DATA

PKGS	VOLUME (Cu Ft)	WEIGHT (Lbs)

MIL-HDBK-161

AN/GRC-77 RADIO REPEATER SET

PROCUREMENT DATA

PROCURING SERVICE: USN
SPEC &/or DWG:

DESIGN COG: USN

CONTRACTOR	LOCATION	CONTRACT OR ORDER NO.	APPROX UNIT COST
------------	----------	--------------------------	---------------------

RADIO SET AN/GRC-78

26 November 1958

Cognizant Serv: USN FSN:

	USA	USN	USAF
TYPE CLASS:	--	Used by	--
STOCK NO:	--	--	--

(No Illustration Available)

FUNCTIONAL DESCRIPTION:

Radio Set AN/GRC-78 is a transportable very-high-frequency and ultra-high-frequency transmitting and receiving equipment. It is used with appropriate multichannel carrier telephone terminal apparatus.

TECHNICAL CHARACTERISTICS:

Transmitter:

Frequency Range in Mc: 100 to 225 and 400 to 600

Number of Bands: 2

Channels: 383

Type Modulation: FM

Power Output: 120 w

Receiver:

Frequency Range in Mc: 100 to 225 and 400 to 600

Number of Bands: 2

Channels: 383

Power Requirements: 115-v 50-cycle 1-phase ac or 230-v 60-cycle 1-phase ac

MAJOR COMPONENTS

QTY	ITEM	STOCK NUMBERS	DIMENSIONS (Inches)	WEIGHT (Lbs)
-----	------	---------------	------------------------	-----------------

REFERENCE DATA AND LITERATURE:

MIL-HDBK-161

AN/GRC-78 RADIO SET

SHIPPING DATA

PKGS	VOLUME (Cu Ft)	WEIGHT (Lbs)
------	----------------	--------------

PROCUREMENT DATA

PROCURING SERVICE: USN
SPEC &/or DWG:

DESIGN COG: USN

CONTRACTOR	LOCATION	CONTRACT OR ORDER NO.	APPROX UNIT COST
------------	----------	-----------------------	------------------

RADIO REPEATER SET **AN/GRC-80**

26 November 1958

Cognizant Serv: USN FSN:

USA

USN

USAF

TYPE CLASS: --

Used by --

STOCK NO: --

(No Illustration Available)

FUNCTIONAL DESCRIPTION:

Radio Repeater Set AN/GRC-80 receives and retransmits multichannel voice (12 voice plus 1 order wire), telegraph, teletypewriter and/or facsimile, and provides a simultaneous two-way radio relay circuit.

TECHNICAL CHARACTERISTICS:

Frequency Range in Mc: 100 to 225 and 400 to 600

Number of Bands: 2

Number of Channels: 383

Type Modulation: FM

Power Requirements: 115-v 50-cycle 1-phase ac or 230-v 60-cycle 1-phase ac

MAJOR COMPONENTS

QTY	ITEM	STOCK NUMBERS	DIMENSIONS (Inches)	WEIGHT (Lbs)
-----	------	---------------	------------------------	-----------------

REFERENCE DATA AND LITERATURE:

SHIPPING DATA

PKGS	VOLUME (Cu Ft)	WEIGHT (Lbs)
------	----------------	--------------

MIL-HDBK-161

AN/GRC-80 RADIO REPEATER SET

PROCUREMENT DATA

PROCURING SERVICE: USN
SPEC &/or DWG:

DESIGN COG: USN

CONTRACTOR	LOCATION	CONTRACT OR ORDER NO.	APPROX UNIT COST
------------	----------	--------------------------	---------------------

RADIO SET **AN/GRC-81**

26 November 1958

Cognizant Serv: USN FSN:

	USA	USN	USAF
TYPE CLASS:	--	Used by	--
STOCK NO:	--	--	--

(No Illustration Available)

FUNCTIONAL DESCRIPTION:

Radio Set AN/GRC-81 is a transportable very-high-frequency and ultra-high-frequency transmitting and receiving equipment. It is used with appropriate multichannel carrier telephone terminal apparatus.

TECHNICAL CHARACTERISTICS:

Frequency Range in Mc: 225 to 400
Number of Bands: 1
Number of Channels: 175
Power Output: 120 w
Type Modulation: FM
Power Requirements: 115-v 50-cycle 1-phase ac or 230-v 60-cycle 1-phase ac

MAJOR COMPONENTS

QTY	ITEM	STOCK NUMBERS	DIMENSIONS (Inches)	WEIGHT (Lbs)
-----	------	---------------	------------------------	-----------------

REFERENCE DATA AND LITERATURE:

MIL-HDBK-161

AN/GRC-81 RADIO SET

SHIPPING DATA

PKGS	VOLUME (Cu Ft)	WEIGHT (Lbs)
------	----------------	--------------

PROCUREMENT DATA

PROCURING SERVICE: USN
SPEC &/or DWG:

DESIGN COG: USN

CONTRACTOR	LOCATION	CONTRACT OR ORDER NO.	APPROX UNIT COST
------------	----------	--------------------------	---------------------

RADIO TERMINAL SET **AN/GRC-82**

26 November 1958

Cognizant Serv: **USN** **FSN:****USA****USN****USAF**

TYPE CLASS: --

Used by --

STOCK NO: --

(No Illustration Available)

FUNCTIONAL DESCRIPTION:

Radio Terminal Set AN/GRC-82 receives and transmits multichannel voice (12 voice plus 1 order wire), telegraph, teletypewriter and/or facsimile in conjunction with appropriate multichannel subcarrier telephone carrier equipment such as Telephone Terminal AN/TCC-7.

TECHNICAL CHARACTERISTICS:*Frequency Range in Mc:* 225 to 400*Power Requirements:* 115-v 50-cycle 1-phase ac or 230-v 60-cycle 1-phase ac**MAJOR COMPONENTS**

QTY	ITEM	STOCK NUMBERS	DIMENSIONS (Inches)	WEIGHT (Lbs)
------------	-------------	----------------------	--------------------------------	-------------------------

REFERENCE DATA AND LITERATURE:**SHIPPING DATA**

PKGS	VOLUME (Cu Ft)	WEIGHT (Lbs)
-------------	-----------------------	---------------------

MIL-HDBK-161

AN/GRC-82 RADIO TERMINAL SET

PROCUREMENT DATA

PROCURING SERVICE: USN
SPEC &/or DWG:

DESIGN COG: USN

CONTRACTOR	LOCATION	CONTRACT OR ORDER NO.	APPROX UNIT COST
------------	----------	--------------------------	---------------------

RADIO SET **AN/GRC-85**

26 November 1958

Cognizant Serv: USN FSN:

USA

USN

USAF

TYPE CLASS:

--

Used by

--

STOCK NO:

--

--

--

(No Illustration Available)

FUNCTIONAL DESCRIPTION:

Radio Set AN/GRC-85 is a single sideband communication equipment operating in the frequency range of 2 to 30 megacycles. It is designed to operate in any one of 10 preset channels.

TECHNICAL CHARACTERISTICS:

Frequency Range in Mc: 2 to 30
Number of Channels: 10; preset
Type of Modulation: Composite
Power Output: 1 kw
Power Requirements: 115/230-v 60-cycle

MAJOR COMPONENTS

QTY	ITEM	STOCK NUMBERS	DIMENSIONS (Inches)	WEIGHT (Lbs)
1	Balance modulator—RF tuner			
2	Control panel			
2	Crystal oscillator			
1	Power amplifier unit			
6	Power supply			
2	Rack, electrical equipment			
2	Receiver audio-RF tuner			
2	Remote control panel			
2	Terminal and junction panel			

REFERENCE DATA AND LITERATURE:**SHIPPING DATA**

PKGS	VOLUME (Cu Ft)	WEIGHT (Lbs)

MIL-HDBK-161

AN/GRC-85 RADIO SET

PROCUREMENT DATA

PROCURING SERVICE: USN
SPEC &/or DWG:

DESIGN COG: USN

CONTRACTOR	LOCATION	CONTRACT OR ORDER NO.	APPROX UNIT COST
------------	----------	--------------------------	---------------------

RADIO SET **AN/GRC-86**

26 November 1958

Cognizant Serv: USN FSN:

USA

USN

USAF

TYPE CLASS: --

Used by

--

STOCK NO: --

--

--

(No Illustration Available)

FUNCTIONAL DESCRIPTION:

Radio Set AN/GRC-86 is a single sideband communication equipment designed to operate in the frequency range of 2 to 30 megacycles.

TECHNICAL CHARACTERISTICS:

Frequency Range in Mc: 2 to 30*Type Modulation:* Composite*Power Output:* 1 kw*Power Requirements:* 115/230-v 60-cycle 1-phase ac

MAJOR COMPONENTS

QTY	ITEM	STOCK NUMBERS	DIMENSIONS (Inches)	WEIGHT (Lbs)
1	Balance modulator—RF tuner			
2	Control panel			
2	Frequency divider unit			
2	Oscillator, RF			
1	Power amplifier unit			
2	Power supply			
2	Rack, electrical equipment			
2	Remote control panel			
2	Stabilized master oscillator			
1	Terminal and junction box			
1	Tuner			

REFERENCE DATA AND LITERATURE:

SHIPPING DATA

PKGS	VOLUME (Cu Ft)	WEIGHT (Lbs)

MIL-HDBK-161

AN/GRC-86 RADIO SET

PROCUREMENT DATA

PROCURING SERVICE: USN
SPEC &/or DWG:

DESIGN COG: USN

CONTRACTOR	LOCATION	CONTRACT OR ORDER NO.	APPROX UNIT COST
------------	----------	--------------------------	---------------------

RADIO SET **AN/GRC-type**

1 July 1958

Cognizant Serv: USA FSN: 5820-192-7140

SCR-543-()

	USA	USN	USAF
TYPE CLASS:	SCR-543-(): Std SCR-543-A, -B, -C: L/Std	--	--
STOCK NO:	2S543	--	--

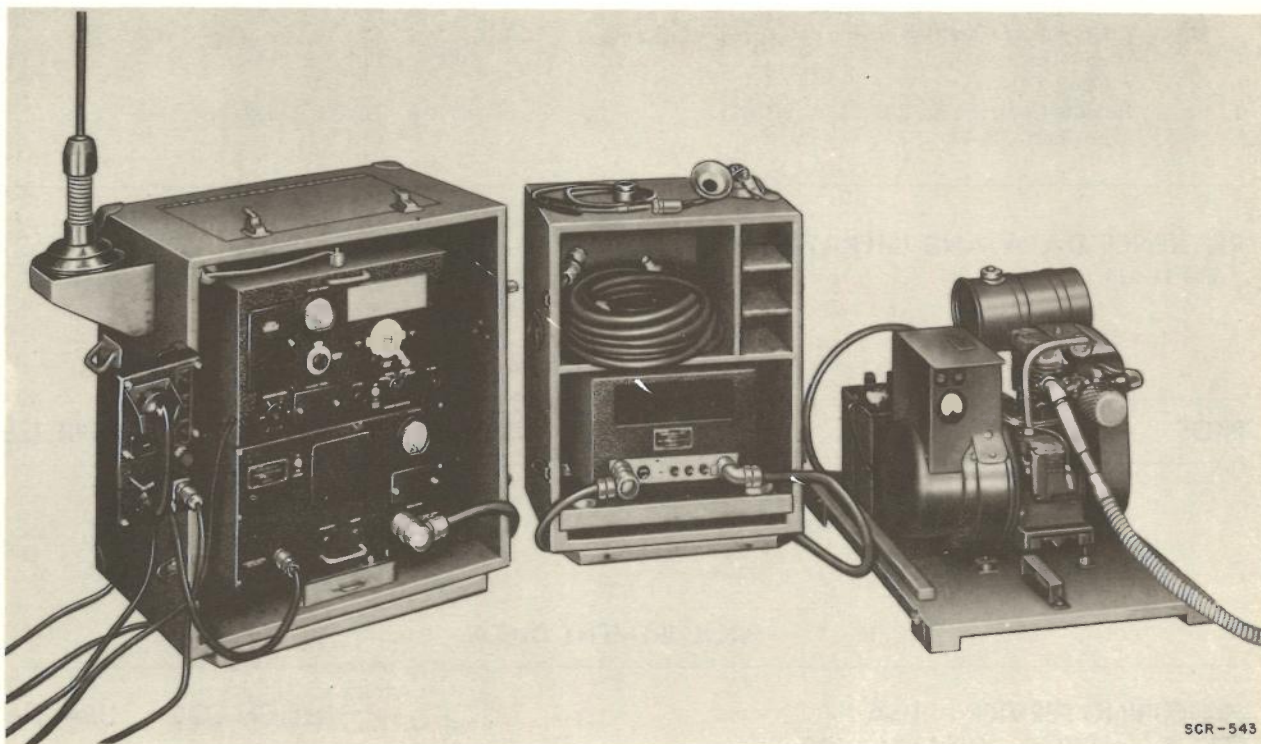

SCR-543

FUNCTIONAL DESCRIPTION:

Radio Set SCR-543-() is a medium range, medium- and high-frequency, AM, radiotelephone equipment for mobile or fixed station use by antiaircraft artillery units.

This equipment consists of a radio receiver and transmitter component, power supply, and associated accessories, and may be installed and operated in a light truck or from a permanent location as a field radiotelephone station. It can be operated with a whip-type or straight-wire antenna.

This equipment may be operated from a remote point by use of Remote Control Unit RM-21.

TECHNICAL CHARACTERISTICS:

Frequency Range in Mc: 1.68 to 4.45

Type Modulation: AM

Type of Signal: Voice and cw

Power Output: 45 w

Power Requirements: Power Unit PE-108, or storage battery

AN/GRC-type RADIO SET**MAJOR COMPONENTS**

QTY	ITEM	STOCK NUMBERS	DIMENSIONS (Inches)	WEIGHT (Lbs)
(USA)				
1	Power Unit PE-108 in Chest CH-131	3H600-108	24 x 23-3/4 x 28	265
1	Radio Receiver and Transmitter BC-669 in Chest CH-133	-----	22-1/2 x 28-3/4 x 27-1/2	216
1	Radio Transmitter BC-699 in Chest CH-33	-----	20-3/8 x 29-3/4 x 28-1/2	182
1	Remote Control Unit RM-21 in Chest CH-73	2C7621	4-1/2 x 10-1/2 x 16-1/2	5

REFERENCE DATA AND LITERATURE:

TM 11-625

SHIPPING DATA

PKGS	VOLUME (Cu Ft)	WEIGHT (Lbs)
	54	1,253

PROCUREMENT DATA

PROCURING SERVICE: USA
 SPEC &/or DWG: (USA) 71-1320

DESIGN COG: USA, Sig C

CONTRACTOR	LOCATION	CONTRACT OR ORDER NO.	APPROX UNIT COST

TRANSMITTER AND RECEIVER EQUIPMENT AN/GRC-type

5 December 1958

Cognizant Serv: USN FSN:

TCH

USA

USN

USAF

TYPE CLASS: --

Used by

--

STOCK NO: --

--

--

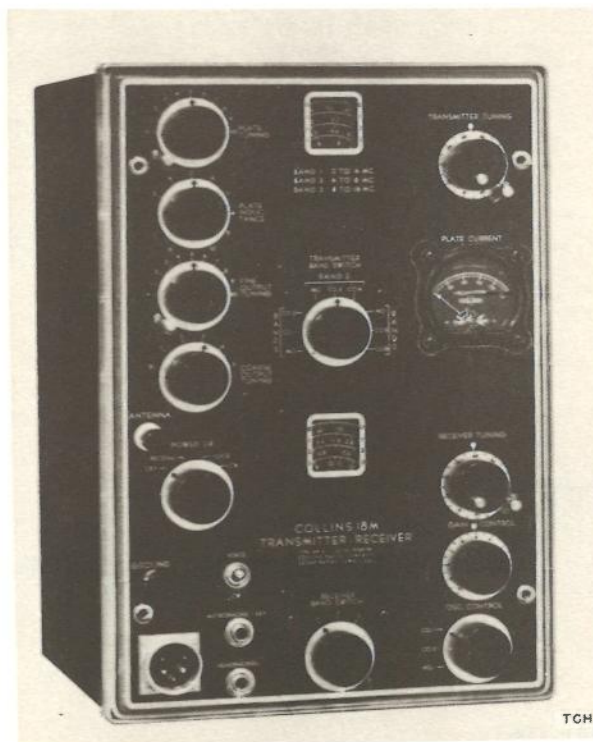

FUNCTIONAL DESCRIPTION:

Transmitter and Receiver Equipment TCH is an hf radio transmitter-receiver for use in the field or on vehicles to provide flexible communication. It uses a master oscillator for continuously variable operation over the frequency range, and has crystal control provisions for any two preset frequencies. However, crystal operation in the 8 to 16 megacycle band is not generally satisfactory.

A wide range of antenna lengths may be used with this equipment. In temporary field installations various counterpoise arrangements are employed, and an 8- to 10-foot rod with suitable loading coil is recommended for vehicular installation.

Equipment required but not supplied: Field Antenna Assembly 37B-2; Engine Driven Battery Charger 231N102.

TECHNICAL CHARACTERISTICS:

Frequency Range in Mc: 2 to 16

Frequency Control: Master oscillator or crystal

Type of Signal: Cw, voice

Type Receiver: Superheterodyne

Power Output:

Transmitter: 15 w on cw; 5 w voice

Receiver: 200 mw maximum into 500-ohm load

Frequency Response: Within 5 db between 400 and 5,000 cps

Keying Speed: 30 wpm

Power Requirements: 102/160/150 w 12/24/32-v dc or 115-v dc/ac

MAJOR COMPONENTS

QTY	ITEM	STOCK NUMBERS	DIMENSIONS (Inches)	WEIGHT (Lbs)
1	Antenna kit			
1	Antenna Loading Coil 190U-1			
4	Battery Cable 65F-5			
1	Canvas Carrying Case 11N13			
3	Control Cable 65F-6			
2	Dual Quartz Crystal Plate Assembly 1E			
1	Headphone 273N3			
1	Microphone, Cord and Plug Assembly 20N404			
4	Power Cable 65F-4			

AN/GRC-type TRANSMITTER AND RECEIVER EQUIPMENT

MAJOR COMPONENTS—Continued

QTY	ITEM	STOCK NUMBERS	DIMENSIONS (Inches)	WEIGHT (Lbs)
4	Power Unit			
	Collins Type 413B-1 (12 v, dc operation)	-----	9-1/2 x 22-1/4 x 12	95.0
	Collins Type 415E-3 (24 v, dc operation)	-----	6-3/8 x 6-5/8 x 3-1/2	8.5
	Collins Type 416T-1 (32 v, dc operation)	-----	6-1/4 x 6-1/2 x 7-1/2	18.0
	Collins Type 416T-2 (115 v, ac/dc)	-----	6-1/4 x 6-1/2 x 7-1/2	18.0
1	Telegraph Key, Cord and Plug Assembly 67A-1			
1	Transmitter-Receiver Unit Collins Type 18M-5	-----	14-1/4 x 9-5/8 x 9-3/4	25.5

REFERENCE DATA AND LITERATURE:

SHIPPING DATA

PKGS	VOLUME (Cu Ft)	WEIGHT (Lbs)
------	----------------	--------------

PROCUREMENT DATA

PROCURING SERVICE:
SPEC &/or DWG:

DESIGN COG:

CONTRACTOR	LOCATION	CONTRACT OR ORDER NO.	APPROX UNIT COST
Collins Radio Co.	Cedar Rapids, Iowa	NOs-75324, 20 Jul 1940	

DIRECTION FINDER SET **AN/GRD-5**

26 November 1958

Cognizant Serv: USN FSN: 5825-642-8184

	USA	USN	USAF
TYPE CLASS:	--	Used by	Ltd-Std
STOCK NO:	--	F16-Q-112796-200	--

(No Illustration Available)

FUNCTIONAL DESCRIPTION:

Direction Finder Set AN/GRD-5 is a receiver and azimuth indicator used in conjunction with ground control approach equipment in locating and homing aircraft. It is installed in a truck or at a control tower installation.

This equipment provides instantaneous azimuth indications of aircraft in flight, on the basis of radio frequency transmissions from the aircraft. It features automatic sensing means so that a single bearing is presented at all times while a signal is being received. Presence of a signal is indicated visually by means of a neon tube.

Direction Finder Set AN/GRD-5 is the production model of Experimental Direction Finder Adaptor for Radar Equipment CXGH-2.

TECHNICAL CHARACTERISTICS:*Frequency Range:*

Manual Tuning: 100 mc to 160 mc

Actual Frequency: 120 mc to 156 mc

Frequency Control: Crystal or continuously variable

Operational Range: Maximum of 135 miles when using a 25-foot antenna and receiving from a standard aircraft transmitter at an altitude of 10,000 ft

Type Receiver: Superheterodyne*Type Reception:* A1, A2, A3*Intermediate Frequency:* 15.09 mc*Output:* Greater than 500 mw into a 600-ohm load; less than 10% distortion*Impedance:*

Input: 50 ohms

Output: 600 ohms

Features: Squelch and noise limiter circuits to eliminate audio output other than from signal*Antenna:* Eight element H-type Adcock with broad band dipoles*Mounting:*

Receiver: Table or rack

Azimuth Indicator: Table

Power Requirements: 276 w 115-v (± 5.75 v) 60-cycle (± 6 cycles) 1-phase ac**MAJOR COMPONENTS**

QTY	ITEM	STOCK NUMBERS	DIMENSIONS (Inches)	WEIGHT (Lbs)
1	Antenna AS-575/GRD-5	-----	57-3/16 x 25-3/8 x 25-3/8	50.0
1	Antenna Mast with Guys AB-307/GRD-5	-----	300 x 192 x 192	
1	Azimuth Indicator ID-317/GRD-5	-----	13 x 6-3/16 x 6-5/8	8.0
5	Cable CX-2174/U	-----	96 lg	2.0
5	Cord CG-92C/U	-----	120 lg	15.0
5	Indicator Cable CX-2175/U	-----	180 lg	2.0
5	Power Cable CX-2176/U	-----	120 lg	35.0
5	Power Input Cable CX-2177/U	-----	96 lg	0.5
1	Radio Receiver R-499/GRD-5	-----	8-25/32 x 17-17/32 x 19-7/32	92.0
1	Set of equipment spares			

REFERENCE DATA AND LITERATURE:

MIL-HDBK-161

AN/GRD-5 DIRECTION FINDER SET

SHIPPING DATA

PKGS	VOLUME (Cu Ft)	WEIGHT (Lbs)
5	40.4	270

PROCUREMENT DATA

PROCURING SERVICE: USN
SPEC &/or DWG: D-52

DESIGN COG: USN

CONTRACTOR	LOCATION	CONTRACT OR ORDER NO.	APPROX UNIT COST
Federal Telecommunications Laboratory, Inc.	Nutley, N. J.	NObsr-49106, 16 May 1950	

TRAINER AN/GRQ-T1

26 November 1958

Cognizant Serv: USN FSN:

	USA	USN	USAF
TYPE CLASS:	--	Used by	--
STOCK NO:	--	--	--

(No Illustration Available)

FUNCTIONAL DESCRIPTION:

Trainer AN/GRQ-T1 is used for instruction of trainees in basic principles of electronics. It has necessary provisions to permit students to build electrical circuits by plugging in patch cords, without the use of tools.

The various components can be used repeatedly without destroying or damaging them. Through the use of additional electronic equipment, application of this trainer can be greatly expanded. The following equipments may be employed: audio frequency generator, oscilloscope, Voltmeter OE,

frequency meter, alternating current and direct current voltmeter, radio frequency signal generator, vacuum tube voltmeter and volt-ohm-milliammeter.

TECHNICAL CHARACTERISTICS:

Oscillator Frequency: 1,600 kc to 3,000 kc*Type Control:* Continuously tuned or crystal*Maximum Operating Current:* 2 amp*Power Requirements:* 105- 125-v 50- to 60-cycle 1-phase ac

MAJOR COMPONENTS

QTY	ITEM	STOCK NUMBERS	DIMENSIONS (Inches)	WEIGHT (Lbs)
1	Cabinet CY-796/GRQ-T1	-----	12-5/16 x 27-3/4 x 31-1/2	27
1	Cabinet CY-797/GRQ-T1	-----	29-1/2 x 32-5/8 x 53-3/4	240
1	Circuit Demonstration Panel MX-1041/GRQ-T1	-----	5-1/4 x 17 x 29-7/8	11
1	Circuit Demonstration Panel MX-1042/GRQ-T1	-----	5-1/4 x 17 x 29-7/8	8.5
1	Circuit Demonstration Panel MX-1043/GRQ-T1	-----	5-1/4 x 17 x 29-7/8	20
1	Circuit Demonstration Panel MX-1044/GRQ-T1	-----	5-1/4 x 17 x 29-7/8	10.5
1	Circuit Demonstration Panel MX-1045/GRQ-T1	-----	5-1/4 x 17 x 29-7/8	26
1	Circuit Demonstration Panel MX-1046/GRQ-T1	-----	5-1/4 x 17 x 29-7/8	8
1	Circuit Demonstration Panel MX-1047/GRQ-T1	-----	5-1/4 x 17 x 20-7/8	11
1	Circuit Demonstration Panel MX-1048/GRQ-T1	-----	5-1/4 x 17 x 29-7/8	11.5
1	Circuit Demonstration Panel MX-1049/GRQ-T1	-----	5-1/4 x 17 x 29-7/8	9.5
1	Circuit Demonstration Panel MX-1050/GRQ-T1	-----	5-1/4 x 17 x 29-7/8	10.5
1	Circuit Demonstration Panel MX-1051/GRQ-T1	-----	5-1/4 x 17 x 29-7/8	11.5
1	Circuit Demonstration Panel MX-1052/GRQ-T1	-----	5-1/4 x 17 x 29-7/8	16
1	Power Supply PP-535/GRQ-T1	-----	8 x 13-7/16 x 29-7/8	58

MIL-HDBK-161

AN/GRQ-T1 TRAINER

REFERENCE DATA AND LITERATURE:

NAVSHIPS 91336

SHIPPING DATA

PKGS	VOLUME (Cu Ft)	WEIGHT (Lbs)
7	77.68	850

PROCUREMENT DATA

PROCURING SERVICE: USN
SPEC &/or DWG:

DESIGN COG: USN, BuShips

CONTRACTOR	LOCATION	CONTRACT OR ORDER NO.	APPROX UNIT COST
A. F. Smuckler and Co. Inc.	Brooklyn, N. Y.	NObsr-43406, 17 June 1949	

TRAINER AN/GRQ-T1A

26 November 1958

Cognizant Serv: USN FSN:

	USA	USN	USAF
TYPE CLASS:	--	Used by	--
STOCK NO:	--	--	--

(No Illustration Available)

FUNCTIONAL DESCRIPTION:

Trainer AN/GRQ-T1A is used in instructing trainees in the basic principles of electronics. It incorporates provisions that permit students to build electrical circuits by plugging in patch cords, without the use of tools.

The various components can be re-used a number of times without destroying or damaging them. Through the use of additional electronic equipment, application of this trainer

can be greatly expanded. The following equipments may be employed, but are not part of the trainer: audio frequency signal generator, radio frequency signal generator, oscilloscope alternating current and direct current voltmeter, vacuum tube voltmeter, and volt-ohm-milliammeter.

TECHNICAL CHARACTERISTICS:

*Maximum Operating Current: 2 amp**Power Requirements: 105- 125-v 50-60-cycle 1-phase ac*

MAJOR COMPONENTS

QTY	ITEM	STOCK NUMBERS	DIMENSIONS (Inches)	WEIGHT (Lbs)
1	Cabinet CY-796/GRQ-T1	-----	12-5/16 x 27-3/4 x 31-1/2	27
1	Cabinet CY-797/GRQ-T1	-----	29-1/2 x 32-5/8 x 53-3/4	240
1	Circuit Demonstration Panel MX-1041A/GRQ-T1	-----	5-1/4 x 17 x 29-7/8	11
1	Circuit Demonstration Panel MX-1042A/GRQ-T1	-----	5-1/4 x 17 x 29-7/8	9.5
1	Circuit Demonstration Panel MX-1043A/GRQ-T1	-----	5-1/4 x 17 x 29-7/8	22
1	Circuit Demonstration Panel MX-1044A/GRQ-T1	-----	5-1/4 x 17 x 29-7/8	10.5
1	Circuit Demonstration Panel MX-1045A/GRQ-T1	-----	5-1/4 x 17 x 29-7/8	30
1	Circuit Demonstration Panel MX-1046A/GRQ-T1	-----	5-1/4 x 17 x 29-7/8	8
1	Circuit Demonstration Panel MX-1047A/GRQ-T1	-----	5-1/4 x 17 x 29-7/8	11
1	Circuit Demonstration Panel MX-1048A/GRQ-T1	-----	5-1/4 x 17 x 29-7/8	12.5
1	Circuit Demonstration Panel MX-1049A/GRQ-T1	-----	5-1/4 x 17 x 29-7/8	10
1	Circuit Demonstration Panel MX-1050A/GRQ-T1	-----	5-1/4 x 17 x 29-7/8	12
1	Circuit Demonstration Panel MX-1051A/GRQ-T1	-----	5-1/4 x 17 x 29-7/8	12
1	Circuit Demonstration Panel MX-1052A/GRQ-T1	-----	5-1/4 x 17 x 29-7/8	16
1	Power Supply PP-535A/ GRQ-T1	-----	8 x 13-7/16 x 29-7/8	63

MIL-HDBK-161

AN/GRQ-T1A TRAINER

REFERENCE DATA AND LITERATURE:
NAVSHIPS 91705

SHIPPING DATA

PKGS	VOLUME (Cu Ft)	WEIGHT (Lbs)
6	79.8	869

PROCUREMENT DATA

PROCURING SERVICE: USN
SPEC &/or DWG:

DESIGN COG: USN, BuShips

CONTRACTOR	LOCATION	CONTRACT OR ORDER NO.	APPROX UNIT COST
Willor Manufacturing Corp.	New York, N. Y.	NObsr-52680, 28 August 1951	\$1,149.21

RADIO SET AN/GRR-2

1 July 1958

Cognizant Serv: USA FSN: 5820-164-7190

USA

USN

USAF

TYPE CLASS:

Obs

Used by

--

STOCK NO:

2C4535.6

--

--

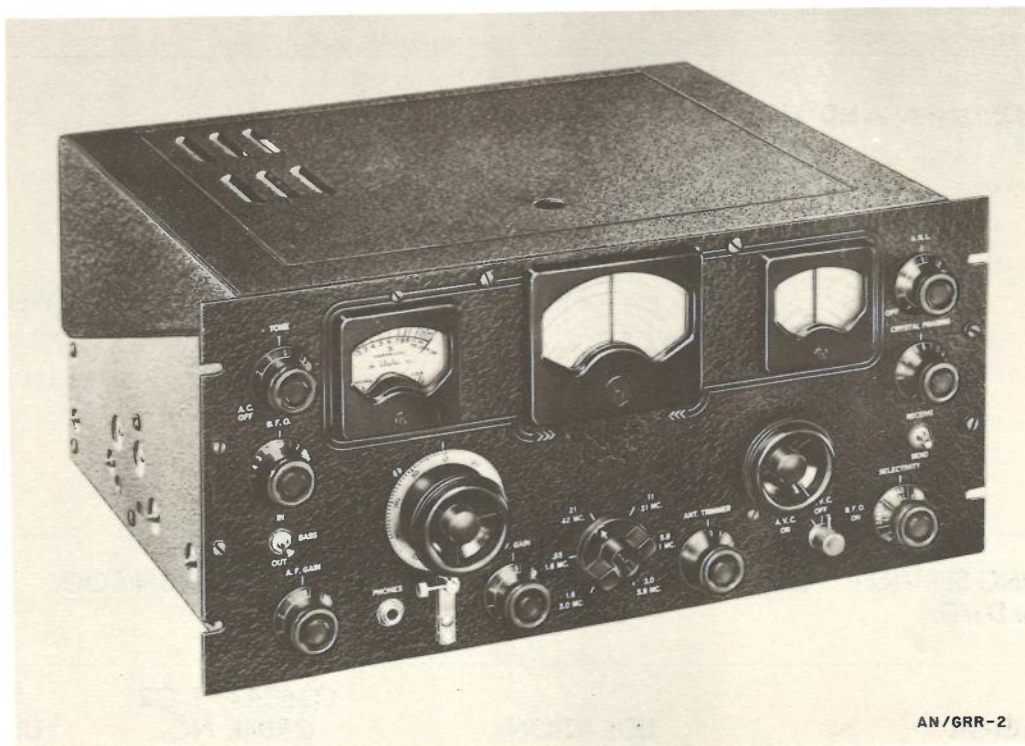

AN/GRR-2

FUNCTIONAL DESCRIPTION:

Radio Set AN/GRR-2 is a crystal-controlled, medium-weight radio receiver for the reception of AM (voice) and cw signals in the mf, hf, and vhf bands. It can be used in permanent or semipermanent stations.

This equipment is essentially a commercial (Hallicrafters SX-28) table-model receiver that may be either cabinet or rack and panel mounted. It has a phonograph jack and three output impedances for headphones and an external 500-ohm or 5,000-ohm permanent magnet speaker. The set can be operated with a conventional inverted L or doublet antenna system.

It has a built-in power supply, and it operates from ac with provision for emergency use of either battery or power pack.

TECHNICAL CHARACTERISTICS:

Frequency Range in Mc: 0.55 to 42 in 6 consecutive bands

Type Modulation: AM

Type of Signal: Voice, tone, keyed cw

Power Output: 8 w undistorted

Power Requirements:

Ac: 138 w, 117-v 60-cycle
or

Dc: Heater supply: 4.8 amp at 6 v

High-voltage supply: 150 ma at 270 v

Power consumption: 108 w

MIL-HDBK-161

AN/GRR-2 RADIO SET

MAJOR COMPONENTS

QTY	ITEM	STOCK NUMBERS	DIMENSIONS (Inches)	WEIGHT (Lbs)
1	Radio Set AN/GRR-2	(FSC) 5820-164-7190 (USA) 2C4535.6	16-1/2 x 20-3/4 x 10-3/4	78

(Equipment consists of only one major component.)

REFERENCE DATA AND LITERATURE:

TM 11-874

SHIPPING DATA

PKGS	VOLUME (Cu Ft)	WEIGHT (Lbs)
1	5.5	135

PROCUREMENT DATA

PROCURING SERVICE: USA
SPEC &/or DWG:

DESIGN COG: USA, Sig C

CONTRACTOR	LOCATION	CONTRACT OR ORDER NO.	APPROX UNIT COST
The Hallicrafter Co.	Chicago, Ill.		

RADIO SET **AN/GRR-3**

1 July 1958
 Cognizant Serv: USA FSN: 5820-223-2495

	USA	USN	USAF
TYPE CLASS:	L/Std	--	--
STOCK NO:	2C4529	--	--

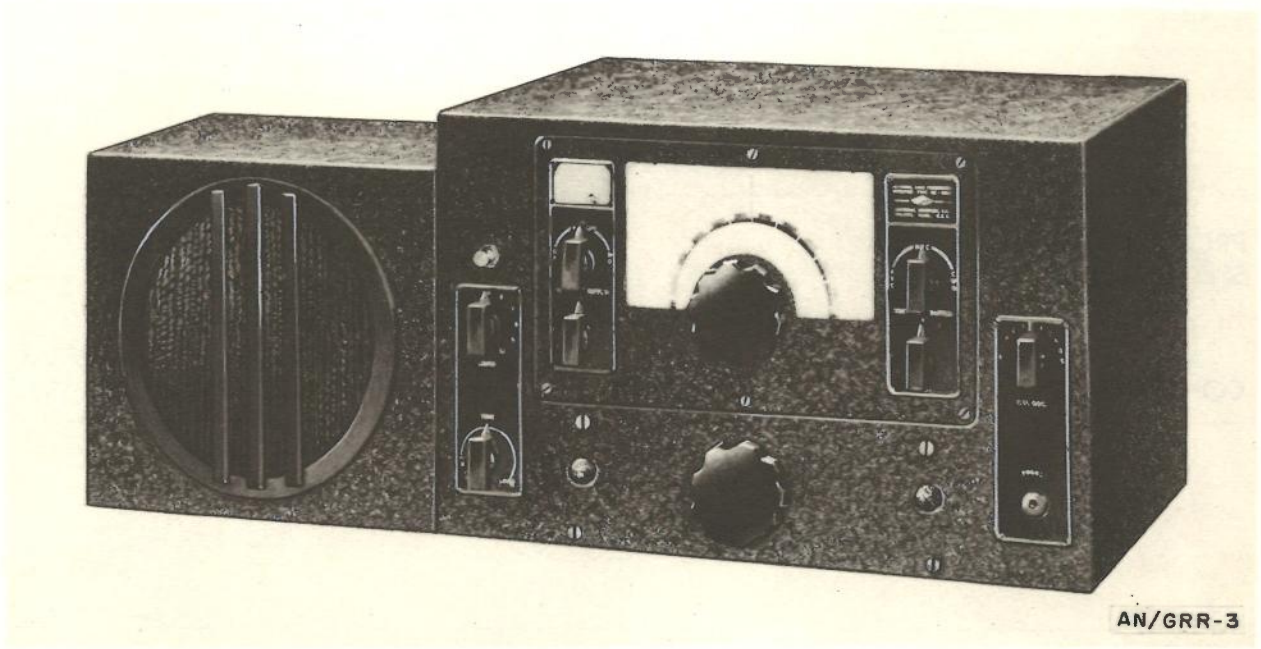

FUNCTIONAL DESCRIPTION:

Radio Set AN/GRR-3 is a transportable, AM (voice, cw, and mew) receiving equipment operating in the lf and mf bands for air-ground, ground, and weather data communication.

This equipment consists essentially of a commercial (National NC-100 ASC) communications type receiver and associated 8-inch inclosed loudspeaker. It has a built-in power supply.

This set can be used with conventional inverted L or T type antennas or with a doublet antenna system.
 This set has been replaced by Radio Receiver BC-779.

TECHNICAL CHARACTERISTICS:

Frequency Range in Mc: 0.2 to 0.4 and 1.3 to 30
Type Modulation: AM
Type of Signal: Voice, cw, mew
Power Requirements: 110-v 60-cycle ac

MAJOR COMPONENTS

QTY	ITEM	STOCK NUMBERS	DIMENSIONS (Inches)	WEIGHT (Lbs)
1	National Receiver NC-100ASC	-----	12 x 19 x 15	65
1	Loudspeaker in cabinet (8" PM)			

MIL-HDBK-161

AN/GRR-3 RADIO SET

REFERENCE DATA AND LITERATURE:

SIG 10-312

SHIPPING DATA

PKGS	VOLUME (Cu Ft)	WEIGHT (Lbs)
------	----------------	--------------

PROCUREMENT DATA

PROCURING SERVICE: USA
SPEC &/or DWG:

DESIGN COG: USA, Sig C

CONTRACTOR	LOCATION	CONTRACT OR ORDER NO.	APPROX UNIT COST
------------	----------	--------------------------	---------------------

RADIO SET AN/SRC-13, -13X, -13Y, -14,
-14X, -14Y, -15, -15X, -15Y

Cognizant Serv: USN FSN:

USA

USN

USAF

TYPE CLASS: --

Used by

STOCK NO: --



AN/SRC-13

FUNCTIONAL DESCRIPTION:

Radio Sets AN/SRC-13, AN/SRC-13X, AN/SRC-13Y, AN/SRC-14, AN/SRC-14X, AN/SRC-14Y, AN/SRC-15, AN/SRC-15X, and AN/SRC-15Y are designed to provide frequency modulated radiotelephone facilities within the frequency range of 20 to 55 megacycles. Each receiver-transmitter covers a specific portion of the over-all frequency range.

These equipments can be installed and operated in trucks, personnel carriers, armored utility vehicles, weapon carriers, and other authorized vehicles.

The radio sets are primarily intended for short range operation and are shipboard installed for amphibious communications.

Radio Sets AN/SRC-13, AN/SRC-13X, AN/SRC-13Y, AN/SRC-14, AN/SRC-14X, AN/SRC-14Y, AN/SRC-15, AN/SRC-15X, and AN/SRC-15Y is nomenclature that has been assigned to identify the United States Navy equivalent to United States Army Radio Sets AN/VRC-16, AN/VRC-17, and AN/VRC-18.

TECHNICAL CHARACTERISTICS:

Frequency Range in Mc:

AN/SRC-13, -13X, -13Y:
RT-66/GRC: 20 to 27.9

R-108/GRC: 20 to 28
AN/SRC-14, -14X, -14Y:
RT-67/GRC: 27 to 38.9
R-109/GRC: 27 to 39
AN/SRC-15, -15X, -15Y:
RT-68/GRC: 38 to 54.9
R-110/GRC: 38 to 55

Type of Emission and Reception: Voice and 1,600 cps fm signals

Type of Tuning:

RT-66/GRC: Continuous or choice of 80 detented channels with provisions for presetting any 2 channels.
RT-67/GRC: Continuous or choice of 120 detented channels with provisions for presetting any 2 channels
RT-68/GRC: Continuous or choice of 170 detented channels with provisions for presetting any 2 channels
R-108/GRC, R-109/GRC, R-110/GRC: Continuous tuning with detent provisions for preselection of any 3 frequencies

Operational Range: 10 to 15 miles

Type of Receivers: Double conversion superheterodyne

Sensitivity of Receivers: 30 db signal plus noise-to-noise ratio with 1/2 uv input signal

AN/SRC-13, -13X, -13Y, -14, RADIO SET -14X, -14Y, -15, -15X, -15Y

Microphone Input Impedance: 150 ohms
Audio Output Impedance: 600 ohms at all audio output terminals

Power Output:

Transmitter:

High: 16 w

Low: 2 w (approximate)

Receivers (Each): 1 w into 600 ohm speakers, 50 mw into 600 ohm phones. (A third output of approximately 30 mw at fixed-level output is not used.)

Power Requirements:

AN/SRC-13, -14, -15: 24 v dc

AN/SRC-13X, -14X, -15X: 12 v dc

AN/SRC-13Y, -14Y, -15Y: 115-v 60-cycle 1-phase ac

MAJOR COMPONENTS

QTY	ITEM	STOCK NUMBERS	DIMENSIONS (Inches)	WEIGHT (Lbs)
<i>For Radio Set AN/SRC-13:</i>				
2	Antenna Assembly AN/ SRA-3			
1	Control Adapter MX-1583/ SRC			
1*	Handset H-33/PT	-----	2-1/16 x 3 x 3	2
1	Mounting MT-327/GRC	-----	4 x 13 x 20	28
1	Power Supply PP-112/GR	-----	8 x 9 x 13	33
1	Power Supply PP-282/GRC	-----	3 x 4-1/2 x 6	6
1	Radio Receiver R-108/GRC	-----	7-1/4 x 9 x 13	35
1	Receiver-Transmitter RT- 66/GRC	-----	9 x 11-1/4 x 13	35
1	Special Purpose Cable As- sembly CX-1211/U			
<i>For Radio Set AN/SRC-13X:</i>				
2	Antenna Assembly AN/ SRA-3			
1	Control Adapter MX-1583/ SRC			
1*	Handset H-33/PT	-----	2-1/16 x 3 x 3	2
1	Mounting MT-327/GRC	-----	4 x 13 x 20	28
1	Power Supply PP-109/GR	-----	8 x 9 x 13	33
1	Power Supply PP-281/GRC	-----	3 x 4-1/2 x 6	6
1	Radio Receiver R-108/GRC	-----	7-1/4 x 9 x 13	35
1	Receiver-Transmitter RT- 66/GRC	-----	9 x 11-1/4 x 13	35
1	Special Purpose Cable As- sembly CX-1211/U			.4
<i>For Radio Set AN/SRC-13Y:</i>				
2	Antenna Assembly AN/ SRA-3			
1	Control Adapter MX-1986/ SRC			
1*	Handset H-33/PT	-----	2-1/16 x 3 x 3	2
1	Mounting MT-327/GRC	-----	4 x 13 x 20	28
1	Power Supply PP-1175/SR	-----	7-5/16 x 9-1/4 x 12-7/8	
1	Radio Receiver R-108/GRC	-----	7-1/4 x 9 x 13	35
1	Receiver-Transmitter RT- 66/GRC	-----	9 x 11-1/4 x 13	35

RADIO SET AN/SRC-13, -13X, -13Y, -14,
-14X, -14Y, -15, -15X, -15Y

MAJOR COMPONENTS—Continued

QTY	ITEM	STOCK NUMBERS	DIMENSIONS (Inches)	WEIGHT (Lbs)
1	Special Purpose Cable Assembly CX-1211/U	-----	-----	.4
	<i>For Radio Set AN/SRC-14:</i>			
2	Antenna Assembly AN/SRA-3	-----	-----	
1	Control Adapter MX-1583/SRC	-----	-----	
1*	Handset H-33/PT	-----	2-1/16 x 3 x 3	2
1	Mounting MT-327/GRC	-----	4 x 13 x 20	28
1	Power Supply PP-112/GR	-----	8 x 9 x 13	33
1	Power Supply PP-282/GRC	-----	3 x 4-1/2 x 6	6
1	Radio Receiver R-109/GRC	-----	7-1/4 x 9 x 13	35
1	Receiver-Transmitter RT-67/GRC	-----	9 x 11-1/4 x 13	35
1	Special Purpose Cable Assembly CX-1211/U	-----	-----	.4
	<i>For Radio Set AN/SRC-14X:</i>			
2	Antenna Assembly AN/SRA-3	-----	-----	
1	Control Adapter MX-1583/SRC	-----	-----	
1*	Handset H-33/PT	-----	2-1/16 x 3 x 3	2
1	Mounting MT-327/GRC	-----	4 x 13 x 20	28
1	Power Supply PP-109/GR	-----	8 x 9 x 13	33
1	Power Supply PP-281/GRC	-----	3 x 4-1/2 x 6	6
1	Radio Receiver R-109/GRC	-----	7-1/4 x 9 x 13	35
1	Receiver-Transmitter RT-67/GRC	-----	9 x 11-1/4 x 13	35
1	Special Purpose Cable Assembly CX-1211/U	-----	-----	.4
	<i>For Radio Set AN/SRC-14Y:</i>			
2	Antenna Assembly AN/SRA-3	-----	-----	
1	Control Adapter MX-1986/SRC	-----	-----	
1*	Handset H-33/PT	-----	2-1/16 x 3 x 3	2
1	Mounting MT-327/GRC	-----	4 x 13 x 20	28
1	Power Supply PP-1175/SR	-----	7-5/16 x 9-1/4 x 12-7/8	
1	Radio Receiver R-109/GRC	-----	7-1/4 x 9 x 13	35
1	Receiver-Transmitter RT-67/GRC	-----	9 x 11-1/4 x 13	35
1	Special Purpose Cable Assembly CX-1211/U	-----	-----	.4
	<i>For Radio Set AN/SRC-15:</i>			
2	Antenna Assembly AN/SRA-3	-----	-----	

AN/SRC-13, -13X, -13Y, -14, RADIO SET
-14X, -14Y, -15, -15X, -15Y

MAJOR COMPONENTS—Continued

QTY	ITEM	STOCK NUMBERS	DIMENSIONS (Inches)	WEIGHT (Lbs)
1	Control Adapter MX-1583/ SRC			
1*	Handset H-33()/PT	-----	2-1/16 x 3 x 3	2
1	Mounting MT-327/GR	-----	4 x 13 x 20	28
1	Power Supply PP-112/GR	-----	8 x 9 x 13	33
1	Power Supply PP-282/GRC	-----	3 x 4-1/2 x 6	6
1	Radio Receiver R-110/GRC	-----	7-1/4 x 9 x 12-13/16	20.25
1	Receiver-Transmitter RT- 68/GRC	-----	9 x 11-1/4 x 13	35
1	Special Purpose Cable As- sembly CX-1211/U	-----		.4
<i>For Radio Set AN/SRC-15X:</i>				
2	Antenna Assembly AN/ SRA-3			
1	Control Adapter MX-1583/ SRC			
1*	Handset H-33()/PT	-----	2-1/16 x 3 x 3	2
1	Mounting MT-327/GR	-----	4 x 13 x 20	28
1	Power Supply PP-109/GR	-----	8 x 9 x 13	33
1	Power Supply PP-281/GRC	-----	3 x 4-1/2 x 6	6
1	Radio Receiver R-110/GRC	-----	7-1/4 x 9 x 12-13/16	20.25
1	Receiver-Transmitter RT- 68/GRC	-----	9 x 11-1/4 x 13	35
1	Special Purpose Cable As- sembly CX-1211/U	-----		.4
<i>For Radio Set AN/SRC-15Y:</i>				
2	Antenna Assembly AN/ SRA-3			
1	Control Adapter MX-1986/ SRC			
1*	Handset H-33()/PT	-----	2-1/16 x 3 x 3	2
1	Mounting MT-327/GR	-----	4 x 13 x 20	28
1	Power Supply PP-1175/SR	-----	7-5/16 x 9-1/4 x 12-7/8	
1	Radio Receiver R-110/GRC	-----	7-1/4 x 9 x 12-13/16	20.25
1	Receiver-Transmitter R- 68/GRC	-----	9 x 11-1/4 x 13	35
1	Special Purpose Cable As- sembly CX-1211/U	-----		.4

* One additional Handset H-33()/PT should be supplied for each control box installed.

RADIO SET **AN/SRC-13, -13X, -13Y, -14,
-14X, -14Y, -15, -15X, -15Y**

REFERENCE DATA AND LITERATURE:

TM 11-611; BuShips Ltr S67/1-7 Ser 881E-1-3528, 1 September 1955

SHIPPING DATA

PKGS	VOLUME (Cu Ft)	WEIGHT (Lbs)
------	----------------	--------------

PROCUREMENT DATA

PROCURING SERVICE: USN
SPEC &/or DWG:

DESIGN COG: USA, Sig C

CONTRACTOR	LOCATION	CONTRACT OR ORDER NO.	APPROX UNIT COST
JFD Manufacturing Co.	Brooklyn, N. Y.	DA-36-039-SC-12166, 31 October 1951	
Signal Corps Supply Agency	Philadelphia, Pa.	MIPR-800-39141, 29 September 1952	

RADIO TRANSMITTING AND RECEIVING EQUIPMENT **AN/SRC-type**

3 December 1958

Cognizant Serv: USN FSN: 5820-665-3823

MAC

	USA	USN	USAF
TYPE CLASS:	--	--	--
STOCK NO:	--	--	--

(No Illustration Available)

FUNCTIONAL DESCRIPTION:

Radio Transmitting and Receiving Equipment MAC is designed for operation on board naval vessels, such as minesweepers, to provide coordinated control of minesweeping equipment on cooperating boats. It has been designed for remote control and unattended operation.

A frequency-modulated short-range radio circuit is provided on which two tone signals may be impressed alternately to operate separate control relays at the receiving points. Means

is provided to limit the effective range to as low as 1,000 yards for security reasons.

TECHNICAL CHARACTERISTICS:*Frequency Range in Mc:* 30 to 42*Type Modulation:* FM*Type of Signal:* Tone*Transmitter Power Output:* 0.01 to 2 w (adjustable)*Transmitter Output Impedance:* 30 to 100 ohms into concentric transmission line*Power Requirements:* 80 w, 115-v 60- to 60-cycle 1-phase ac**MAJOR COMPONENTS**

QTY	ITEM	STOCK NUMBERS	DIMENSIONS (Inches)	WEIGHT (Lbs)
1	Antenna Assembly 66044	-----	4 x 4 x 78	3
1	Coaxial antenna cable	-----	100 feet long	11
1	Control cable with Plugs	-----	75 feet long	18
1	Power cable with Plugs	-----	10 feet long	1.5
1	Radio Transmitter-Receiver Unit 43052	-----	9 x 11-11/16 x 16	38
1	Remote Control Unit 23397	-----	3-1/8 x 4-1/2 x 5	4.5
1	Test Meter, Link Type 1410	-----		5

REFERENCE DATA AND LITERATURE:

NAVSHIPS 95122

SHIPPING DATA

PKGS	VOLUME (Cu Ft)	WEIGHT (Lbs)

AN/SRC-type RADIO TRANSMITTING AND RECEIVING EQUIPMENT

PROCUREMENT DATA

PROCURING SERVICE: USN
SPEC &/or DWG:

DESIGN COG: USN, BuShips

CONTRACTOR	LOCATION	CONTRACT OR ORDER NO.	APPROX UNIT COST
Fred M. Link	New York, N. Y.	NXss 32846	\$140.00

RADIO SET AN/SRC-type

1 July 1958

Cognizant Serv: USA FSN: 5820-186-9257

SCR-28-()

	USA	USN	USAF
TYPE CLASS:	L/Std	--	L/Std
STOCK NO:	2S281	--	--



SCR-281

FUNCTIONAL DESCRIPTION:

Radio Set SCR-281-() is a medium-power, crystal-controlled AM (voice) transmitting and receiving equipment used for ship-to-ship, ship-to-shore, and shore station communication in coastwise and harbor-control applications.

This equipment consists of a radio transmitter and a radio receiver assembled within a single metal cabinet that may be floor-, deck-, shelf-, or platform-mounted. It has a shock mounting and a handset, and the receiver section includes a loudspeaker.

It can be operated on one of four channels, preselected by means of appropriate plug-in crystals, and includes provision for control of transmitter-receiver change-over by means of the press-to-talk switch of the handset.

It can use a conventional long-wire antenna or equivalent system but it can be operated with a whip-type array 35 feet in length.

TECHNICAL CHARACTERISTICS:

Frequency Range in Mc: 1.7 to 2.75

Type Modulation: AM

Type of Signal: Voice only

Power Output: 25 w

Power Requirements:

Transmitter: 230 w, 115-v 60-cycle 1-phase ac

Receiver: 107 w, 115-v 60-cycle 1-phase ac

MIL-HDBK-161

AN/SRC-type RADIO SET

MAJOR COMPONENTS

QTY	ITEM	STOCK NUMBERS	DIMENSIONS (Inches)	WEIGHT (Lbs)
		(USA)		
1	Radio Receiver and Transmitter BC-441	2C5341	16 x 10 x 16	102
2	Shockproof mounting bracket	-----	1-1/2 x 2-1/2 x 17-7/8	4

REFERENCE DATA AND LITERATURE:

TM 11-244.

SHIPPING DATA

PKGS	VOLUME (Cu Ft)	WEIGHT (Lbs)
	6	143

PROCUREMENT DATA

PROCURING SERVICE: USA
SPEC &/or DWG: (USA) 71-3402

DESIGN COG: USA, Sig C

CONTRACTOR	LOCATION	CONTRACT OR ORDER NO.	APPROX UNIT COST
------------	----------	--------------------------	---------------------

RADIO TELEPHONE TRANSMITTING AND RECEIVING EQUIPMENT **AN/SRC-type**

5 December 1958

Cognizant Serv: USN FSN:

TCP

USA

USN

USAF

TYPE CLASS: --

STOCK NO: --

Used by

(32-v dc): F16-Q-

323895-200

(115-v dc): F16-Q-

323905-200



TCP

FUNCTIONAL DESCRIPTION:

Radio Telephone Transmitting and Receiving Equipment TCP, TCP-1, -2, and -3 are designed for two-way radio telephone communication at medium frequency between ships, and between ships and associated shore activities. Each transmitter-receiver is capable of operation from several types of power supplies, depending upon the type of installation desired.

All models of the TCP series are similar except for minor modifications on the later models and the alternating current power supply equipment available with the TCP-3.

TECHNICAL CHARACTERISTICS:*Frequency Range:*

Transmitter: 2,000 to 3,000 kc, 10 preset channels maximum

Receiver: 2,000 to 3,000 kc, 10 preset channels maximum

Frequency Control: Crystal*Type Signal:* Voice*Nominal Power Output:* 75 w*Type Receiver:* Superheterodyne*Receiver Output Impedance:* 4 ohms, 200 ohms*Receiver Sensitivity:* 50 mw audio output for 2 to 5 uv input*Power Requirements:* 32/115-v dc

AN/SRC-type RADIO TELEPHONE TRANSMITTING AND RECEIVING EQUIPMENT**MAJOR COMPONENTS**

QTY	ITEM	STOCK NUMBERS	DIMENSIONS (Inches)	WEIGHT (Lbs)
1	Hand Telephone Assembly CRM-51026	-----	9 x 3-1/2 x 6-1/4	4
1	Line Filter Unit CRM-53076 (32-v de)	-----	10 x 6-1/2 x 6	6
	or			
1	Line Filter Unit CRM-53077 (115-v de)	-----	10 x 6-1/2 x 6	6
2	Remote control cable	-----		
1	Remote Control Unit CRM- 23230	-----	10-1/4 x 13-5/8 x 5-3/8	11
1	Transmitter-Receiver Unit CRM-43009 (32-v de)	-----	37 x 20-1/8 x 22	310
	or			
1	Transmitter-Receiver Unit CRM-43010 (115-v de)	-----	37 x 20-1/8 x 22	310

REFERENCE DATA AND LITERATURE:

NAVSHIPS 95316

SHIPPING DATA

PKGS	VOLUME (Cu Ft)	WEIGHT (Lbs)
2	40.0	578

PROCUREMENT DATA

PROCURING SERVICE: USN
SPEC & /or DWG:

DESIGN COG: USN, BuShips

CONTRACTOR	LOCATION	CONTRACT OR ORDER NO.	APPROX UNIT COST
Radiomarine Corp. of America	New York, N. Y.	NOs-81903, 12 February 1941	\$2,200.00 in- cluding equip- ment spares

RADIO TELEPHONE TRANSMITTING AND RECEIVING EQUIPMENT **AN/SRC-type**

5 December 1958

Cognizant Serv: USN FSN:

TCP-1

USA

USN

USAF

TYPE CLASS:
STOCK NO:Used by
(32-v dc): F16-Q-
323925-200
(115-v dc): F16-Q-
323935-200

(See Illustration of TCP, p. 1205)

FUNCTIONAL DESCRIPTION:

Radio Telephone Transmitting and Receiving Equipment TCP-1 and TCP, -2, and -3 are designed for two-way radio telephone communication at medium frequency between ships, and between ships and associated shore activities. Each transmitter-receiver is capable of operation from several types of power supplies, depending upon the type of installation desired.

All models of the TCP series are similar except for minor modifications on the later models and the alternating current power supply equipment available with the TCP-3.

TECHNICAL CHARACTERISTICS:

Frequency Range:

Transmitter: 2,000 to 3,000 kc, 10 preset channels maximum

Receiver: 2,000 to 3,000 kc, 10 preset channels maximum

Frequency Control: Crystal*Type Signal:* Voice*Nominal Power Output:* 75 w*Type Receiver:* Superheterodyne*Receiver Output Impedance:* 4 ohms, 200 ohms*Receiver Sensitivity:* 50 mw audio output for 2 to 5 uv input*Power Requirements:* 32/115-v dc

MAJOR COMPONENTS

QTY	ITEM	STOCK NUMBERS	DIMENSIONS (Inches)	WEIGHT (Lbs)
1	Hand Telephone Assembly CRM-51026	-----	9 x 3-1/2 x 6-1/4	4
1	Line Filter Unit CRM-53085 (32-v dc)	-----	10-9/16 x 9-3/8 x 3-5/8	9
	or			
1	Line Filter Unit CRM-53086 (115-v dc)	-----	10-9/16 x 9-3/8 x 3-5/8	9
2	Remote control cable			
1	Remote Control Unit CRM- 23230	-----	10-1/4 x 13-5/8 x 5-3/8	11
1	Transmitter-Receiver Unit CRM-43009 (32-v dc)	-----	37 x 20-1/8 x 22	310
	or			
1	Transmitter-Receiver Unit CRM-43010 (115-v dc)	-----	37 x 20-1/8 x 22	310

MIL-HDBK-161

AN/SRC-type RADIO TELEPHONE TRANSMITTING AND RECEIVING EQUIPMENT

REFERENCE DATA AND LITERATURE:

NAVSHIPS 95316

SHIPPING DATA

PKGS	VOLUME (Cu Ft)	WEIGHT (Lbs)
2	40.0	578

PROCUREMENT DATA

PROCURING SERVICE: USN
SPEC &/or DWG:

DESIGN COG: USN, BuShips

CONTRACTOR	LOCATION	CONTRACT OR ORDER NO.	APPROX UNIT COST
Radiomarine Corp. of America	New York, N. Y.	NOs-87455, 18 June 1941	\$2,200.00 including equipment spares

RADIO TELEPHONE TRANSMITTING AND RECEIVING EQUIPMENT **AN/SRC-type**

5 December 1958

Cognizant Serv: USN FSN:

TCP-2

	USA	USN	USAF
TYPE CLASS:	--	Used by	--
STOCK NO:	--	(32-v dc): F16-Q- 323955-200 (Navy)	--
		(115-v dc): F16-Q- 323965-200 (Navy)	

(See Illustration of TCP, p. 1205)

FUNCTIONAL DESCRIPTION:

Radio Telephone Transmitting and Receiving Equipment TCP-2 and TCP, -1 and -3 are designed for two-way radio telephone communication at medium frequency between ships, and between ships and associated shore activities. Each transmitter-receiver is capable of operation from several types of power supplies, depending upon the type of installation desired.

All models of the TCP series are similar except for minor modifications on the later models and the alternating current power supply equipment available with the TCP-3.

TECHNICAL CHARACTERISTICS:*Frequency Range:*

Transmitter: 2,000 to 3,000 kc, 10 preset channels maximum

Receiver: 2,000 to 3,000 kc, 10 preset channels maximum

Frequency Control: Crystal*Type Signal:* Voice*Nominal Power Output:* 75 w*Type Receiver:* Superheterodyne*Receiver Output Impedance:* 4 ohms, 200 ohms*Receiver Sensitivity:* 50 mw audio output for 2 to 5 uv input*Power Requirements:* 32/115-v dc**MAJOR COMPONENTS**

QTY	ITEM	STOCK NUMBERS	DIMENSIONS (Inches)	WEIGHT (Lbs)
1	Hand Telephone Assembly CRM-51026	-----	9 x 3-1/2 x 6-1/4	4
1	Line Filter Unit CRM-53085 (32-v dc)	-----	10-9/16 x 9-3/8 x 3-5/8	9
	or			
1	Line Filter Unit CRM-53086 (115-v dc)	-----	10-9/16 x 9-3/8 x 3-5/8	9
1	Remote control cable	-----		
1	Remote Control Unit CRM- 23230	-----	10-1/4 x 13-5/8 x 5-3/8	11
1	Transmitter-Receiver Unit CRM-43009-A (32-v dc)	-----	37 x 20-1/8 x 22	310
	or			
1	Transmitter-Receiver Unit CRM-43010-A (115-v dc)	-----	37 x 20-1/8 x 22	310

AN/SRC-type RADIO TELEPHONE TRANSMITTING AND RECEIVING EQUIPMENT

REFERENCE DATA AND LITERATURE:

NAVSHIPS 95317

SHIPPING DATA

PKGS	VOLUME (Cu Ft)	WEIGHT (Lbs)
2	40.0	578

PROCUREMENT DATA

PROCURING SERVICE: USN
SPEC &/or DWG:

DESIGN COG: USN, BuShips

CONTRACTOR	LOCATION	CONTRACT OR ORDER NO.	APPROX UNIT COST
Radiomarine Corp. of America	New York, N. Y.	NXsr-36947, 6 September 1943	\$2,200.00 including equipment spares

RADIO TELEPHONE TRANSMITTING AND RECEIVING EQUIPMENT **AN/SRC-type**

5 December 1958

Cognizant Serv: USN FSN:

TCP-3

USA

USN

USAF

TYPE CLASS: --

STOCK NO: --

Used by

(115-v dc): F16-Q-
323975-200 (Navy)(230-v dc): F16-Q-
323976-200 (Navy)

TCP-3

FUNCTIONAL DESCRIPTION:

Radio Telephone Transmitting and Receiving Equipment TCP-3 and TCP, -1, and -2 are designed for two-way radio telephone communication at medium frequency between ships, and between ships and associated shore activities. Each transmitter-receiver is capable of operation from several types of power supplies, depending upon the type of installation desired.

All models of the TCP series are similar except for minor modifications on the later models and on this, the TCP-3, the alternating current power supply equipment that is available.

TECHNICAL CHARACTERISTICS:*Frequency Range:*

Transmitter: 2,000 to 3,000 kc, 10 preset channels maximum

Receiver: 2,000 to 3,000 kc, 10 preset channels maximum

Frequency Control: Crystal*Type Signal:* Voice*Nominal Power Output:* 75 w*Type Receiver:* Superheterodyne*Receiver Output Impedance:* 4 ohms, 200 ohms*Receiver Sensitivity:* 50 mw audio output for 2 to 5 uv input*Power Requirements:* 32/115/230-v dc or 115-v 50-60-cycle 1-phase ac**MAJOR COMPONENTS**

QTY	ITEM	STOCK NUMBERS	DIMENSIONS (Inches)	WEIGHT (Lbs)
1	Hand Telephone Assembly CRM-51026	-----	9 x 3-1/2 x 6-1/4	4
1	Line Filter Unit CRM-53085 (32-v dc)	-----	10-9/16 x 9-3/8 x 3-5/8	9

AN/SRC-type RADIO TELEPHONE TRANSMITTING AND RECEIVING EQUIPMENT

MAJOR COMPONENTS—Continued

QTY	ITEM	STOCK NUMBERS	DIMENSIONS (Inches)	WEIGHT (Lbs)
	or			
1	Line Filter Unit CRM-53086 (115-v dc)	-----	10-9/16 x 9-3/8 x 3-5/8	9
	or			
1	Line Filter Unit CRM-53192 (230-v dc)			
1	Remote control cable			
1	Remote Control Unit CRM- 23230	-----	10-1/4 x 13-5/8 x 5-3/8	11
1	Transmitter-Receiver Unit CRM-43009-A (32-v dc)	-----	37 x 20-1/8 x 22	310
	or			
1	Transmitter-Receiver Unit CRM-43010-A (115-v dc)	-----	37 x 20-1/8 x 22	310
	or			
1	Transmitter-Receiver Unit CRM-43061 (230-v dc)	-----	37 x 20-1/8 x 22	310
	or			
1	Transmitter-Receiver Unit CRM-43062 (115-v 50-60- cycle 1-phase ac)	-----	37 x 20-1/8 x 22	310

REFERENCE DATA AND LITERATURE:

NAVSHIPS 95318

SHIPPING DATA

PKGS	VOLUME (Cu Ft)	WEIGHT (Lbs)
2	40.0	578

RADIO TELEPHONE TRANSMITTING AND RECEIVING EQUIPMENT AN/SRC-type

PROCUREMENT DATA

PROCURING SERVICE: USN
SPEC &/or DWG:**DESIGN COG:** USN, BuShips

CONTRACTOR	LOCATION	CONTRACT OR ORDER NO.	APPROX UNIT COST
Radiomarine Corp. of America	New York, N. Y.	NXsr-55686, 19 April 1944	\$2,200.00 including equipment spares

RADIO SET AN/GRR-5()

1 July 1958

Cognizant Serv: USA FSN: 5820-248-3508

USA

USN

USAF

TYPE CLASS: Std
 STOCK NO: 2S2505-5

--

Std

--

--



FUNCTIONAL DESCRIPTION:

Radio Set AN/GRR-5() is a low-power, AM (voice, cw, and mcw) radio receiving equipment that operates in the mf and hf ranges. It is a general purpose set used in infantry divisions and is intended to replace Radio Set SCR-593.

This equipment consists essentially of a superheterodyne radio receiver having an integral loudspeaker and a shock mount. It is provided with a protective canvas carrying case.

Three types of antennas (whip-type, doublet, and straight wire) and an integral power supply are included. It operates from 110-v ac power or from 6-, 12-, or 24-v storage batteries. It can be operated for about 48 hours on Battery BA-48, which can be mounted on top of the equipment.

TECHNICAL CHARACTERISTICS:

Frequency Range in Mc: 1.5 to 18.0 in 4 bands

Type Modulation: AM

Type of Signal: Cw, mcw, voice

Power Output: 20 to 90 mw

Power Requirements:

Dry Batteries: 350 to 450 ma at 1.4-v dc, and 20 to 27 ma at 90-v dc

or

Power Supply PP-308/URR: 5.0 amp at 6-v dc; 2.5 amp at 12-v dc; 1.75 amp at 24-v dc; or 0.5 amp at 110-v ac

MAJOR COMPONENTS

QTY	ITEM	STOCK NUMBERS	DIMENSIONS (Inches)	WEIGHT (Lbs)
(USA)				
1	Case CY-615/URR	6F300-615	13-7/32 x 12-1/8 x 8-1/16	8.6
1	Power Supply PP-308/URR	3H4497-308	9-3/4 x 13 x 6-1/2	26
1	Rack MT-768/URR	-----	5-1/2 x 9-5/16 x 13-1/16	7
1	Radio Receiver R-174/URR	2C4180-174	9-3/4 x 13-1/4 x 6-1/2	18.9

REFERENCE DATA AND LITERATURE:

TM 11-295

MIL-HDBK-161

AN/GRR-5() RADIO SET

SHIPPING DATA

PKGS	VOLUME (Cu Ft)	WEIGHT (Lbs)
1	17	162

PROCUREMENT DATA

PROCURING SERVICE: USA
SPEC &/or DWG: MIL-R-10138

DESIGN COG: USA, Sig C

CONTRACTOR	LOCATION	CONTRACT OR ORDER NO.	APPROX UNIT COST
Emerson Radio & Phono. Corp.	Jersey City, N. J.	3154-P-51-01	\$835.78
Motorola, Inc.	Chicago, Ill.	15166-P-52-01	
Zenith Radio Corp.	Chicago, Ill.	15165-P-52-13	

RADIO RECEIVING SET **AN/GRR-7**

26 November 1958

Cognizant Serv: USAF FSN:

USA

USN

USAF

TYPE CLASS:
STOCK NO:

Alt-Std

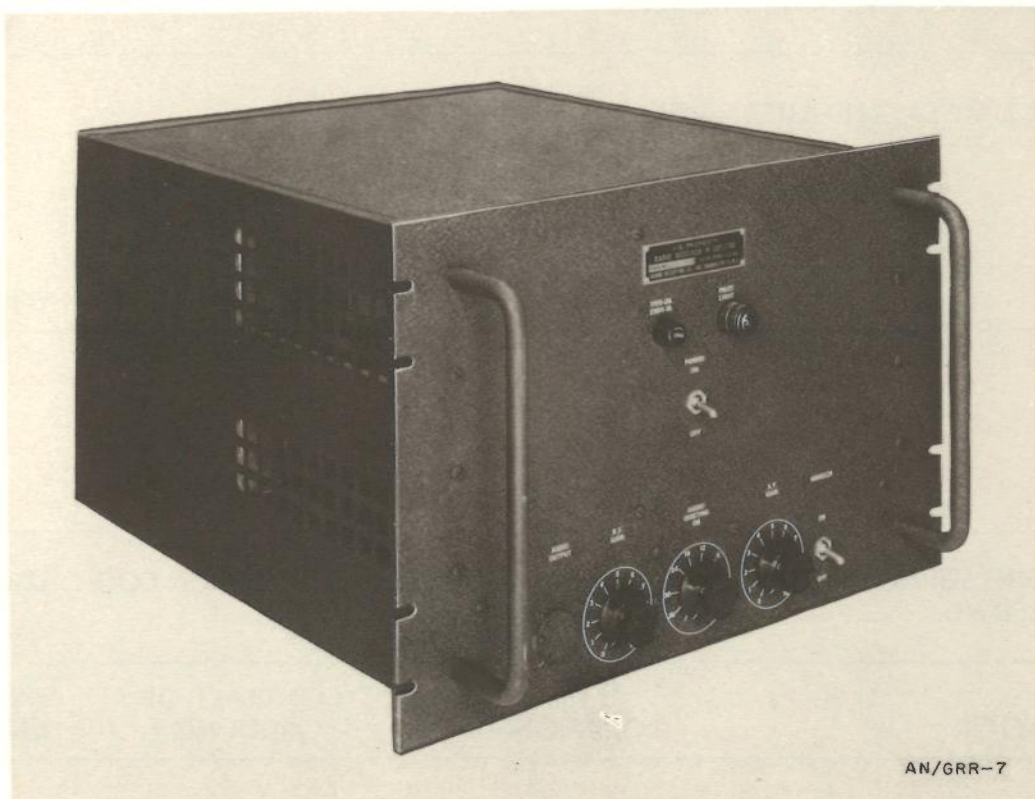
**FUNCTIONAL DESCRIPTION:**

Radio Receiving Set AN/GRR-7 is a general communication equipment used for ground operation, for air-to-ground, and point-to-point communication. Primary application is for control tower and airway station operation. It has sufficient output to operate a loudspeaker.

This equipment is a double conversion superheterodyne with a second IF of 6 megacycles. It is thus subject to interference from high frequency transmitters operating on or near this frequency.

The radio frequency input circuit is intended to operate from the following antennas: AT-197/GR, AS-505/GR,

and AS-450/GR. It is normally used with, but not part of, Radio Transmitter Set AN/GRT-3.

TECHNICAL CHARACTERISTICS:

Frequency Range in Mc: 225 to 399.9

Spacing Between Individual Channels: 100 kc

Type Control: Crystal

Type Modulation: AM

Type Signal: Voice or tone

Power Output: 1 w into 600-ohm load

Power Requirements: 200 w, 115/230-v 60-cycle 1-phase ac

MIL-HDBK-161

AN/GRR-7 RADIO RECEIVING SET

MAJOR COMPONENTS

QTY	ITEM	STOCK NUMBERS	DIMENSIONS (Inches)	WEIGHT (Lbs)
1	Radio Receiver R-361/GR (Equipment consists of only one major component.)		19 x 12-1/4 x 19	50

REFERENCE DATA AND LITERATURE:

TO AN 16-30GRR-7-1

SHIPPING DATA

PKGS	VOLUME (Cu Ft)	WEIGHT (Lbs)
1	2.5	62

PROCUREMENT DATA

PROCURING SERVICE: USAF
SPEC &/or DWG:

DESIGN COG: USAF, RADC

CONTRACTOR	LOCATION	CONTRACT OR ORDER NO.	APPROX UNIT COST
------------	----------	--------------------------	---------------------

RADIO RECEIVER AN/GRR-type

4 December 1958

Cognizant Serv: USA FSN: 5820-164-6373

BC-342

USA

USN

USAF

TYPE CLASS:

Std

Used by

STOCK NO:

2C4342

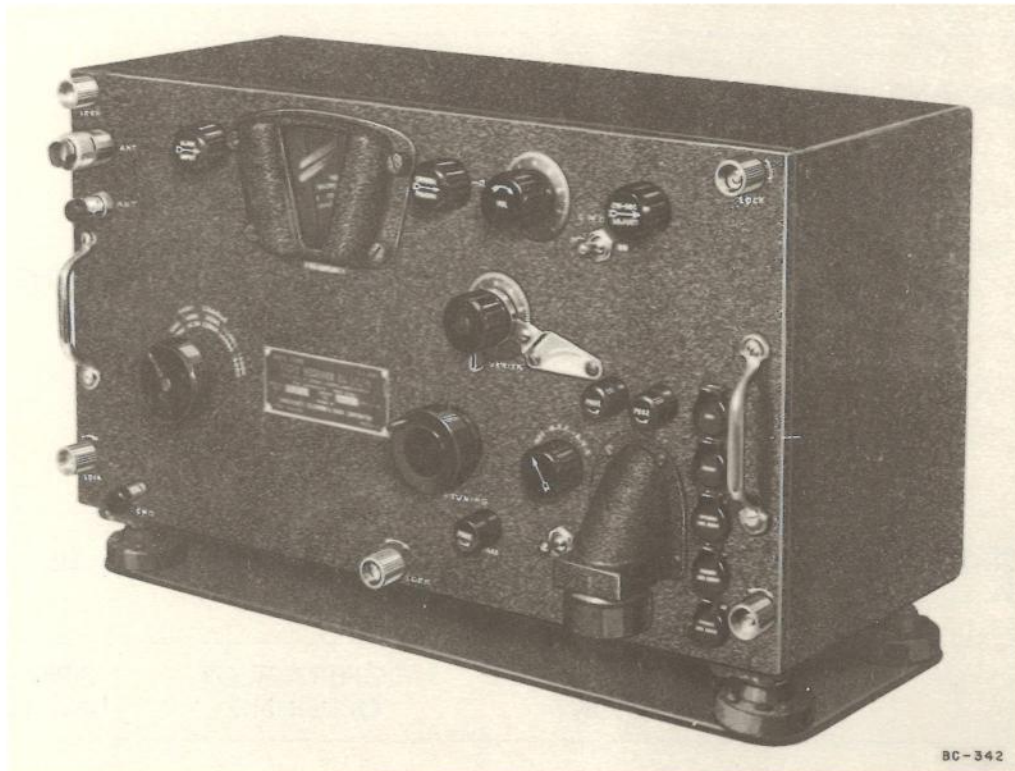

BC-342

FUNCTIONAL DESCRIPTION:

Radio Receiver BC-342 is a lightweight receiving equipment which operates in the medium-frequency and high-frequency bands and is the operational equivalent of Radio Receiver BC-312. It is designed for general purpose ground, mobile, or fixed station use at division or higher headquarters.

This equipment is a highly sensitive and selective self-contained radio receiver inclosed in a metal cabinet. It is used as a component of Radio Set SCR-399 and similar equipment.

Radio Receiver BC-342 uses a whip-type or straight wire antenna and operates from a 115-volt alternating-current power source.

TECHNICAL CHARACTERISTICS:

Frequency Range in Mc: 1.5 to 18.0 (overall)

Band A: 1.5 to 3.0 mc

Band B: 3.0 to 5.0 mc

Band C: 5.0 to 8.0 mc

Band D: 8.0 to 11.0 mc

Band E: 11.0 to 14.0 mc

Band F: 14.0 to 18.0 mc

Intermediate Frequency: 470Kc

Receiver Type: Superheterodyne

Type Modulation: AM

Type of Signal: Cw, tone, voice

Power Requirements: 75 w, 115-v, 50- to 60-cps ac

MIL-HDBK-161

AN/GRR-type RADIO RECEIVER

MAJOR COMPONENTS

QTY	ITEM	STOCK NUMBERS	DIMENSIONS (Inches)	WEIGHT (Lbs)
1	Radio Receiver BC-342 (Equipment consists of only one major component.)	2C4342	10 x 9-1/16 x 18-1/16	61.5

REFERENCE DATA AND LITERATURE:

TM 11-850

SHIPPING DATA

PKGS	VOLUME (Cu Ft)	WEIGHT (Lbs)
1	4.7	120

PROCUREMENT DATA

PROCURING SERVICE: USA
SPEC &/or DWG:

DESIGN COG: USA, Sig C

CONTRACTOR	LOCATION	CONTRACT OR ORDER NO.	APPROX UNIT COST
------------	----------	--------------------------	---------------------

RADIO RECEIVER AN/GRR-type

25 November 1958

Cognizant Serv: USA FSN: 5820-164-6370

BC-344-()

USA

USN

USAF

TYPE CLASS:

Obs

Used by

--

STOCK NO:

2C4344

--

--



BC-344

FUNCTIONAL DESCRIPTION:

Radio Receiver BC-344-() is a lightweight, portable, amplitude-modulated radio receiving equipment used for voice, continuous-wave, and tone signal communication in the low- and medium-frequency bands. It is the alternating-current version of battery-operated Radio Receiver BC-314.

This equipment, consisting of a single, cabinet-inclosed radio receiver, can be operated with straight wire or rhombic-type antennas, doublet antenna systems, and antennas of special design as required.

TECHNICAL CHARACTERISTICS:

Frequency Range in Mc: 0.15 to 1.50 (overall) in four bands

Band A: 0.15 to 0.26

Band B: 0.26 to 0.45

Band C: 0.45 to 0.82

Band D: 0.82 to 1.50

Intermediate Frequency: 92.5 kc

Type Modulation: AM

Type Receiver: Superheterodyne

Type Reception: Cw, tone, voice

Power Requirements: 75 w, 110- to 120-v 50- to 60-cycle ac

MIL-HDBK-161

AN/GRR-type RADIO RECEIVER

MAJOR COMPONENTS

QTY	ITEM	STOCK NUMBERS	DIMENSIONS (Inches)	WEIGHT (Lbs)
		(USA)		
1	Mounting FT-162	2Z6702	1-1/4 x 6-7/8 x 18	3.75
1	Radio Receiver BC-344()	2C4344	10 x 9-1/16 x 18-1/16	61.5
1 set	Spare parts			

REFERENCE DATA AND LITERATURE:

TM 11-850

SHIPPING DATA

PKGS	VOLUME (Cu. Ft)	WEIGHT (Lbs)
1	4.7	120

PROCUREMENT DATA

PROCURING SERVICE: USA
SPEC &/or DWG:

DESIGN COG: USA, Sig C

CONTRACTOR	LOCATION	CONTRACT OR ORDER NO.	APPROX UNIT COST
------------	----------	--------------------------	---------------------

RADIO RECEIVER **AN/GRR-type**

1 July 1958

Cognizant Serv: USA FSN: 5820-503-1398

R-137/GR

USA

USN

USAF

TYPE CLASS:

L/Std

--

--

STOCK NO:

2C4537-36

--

--

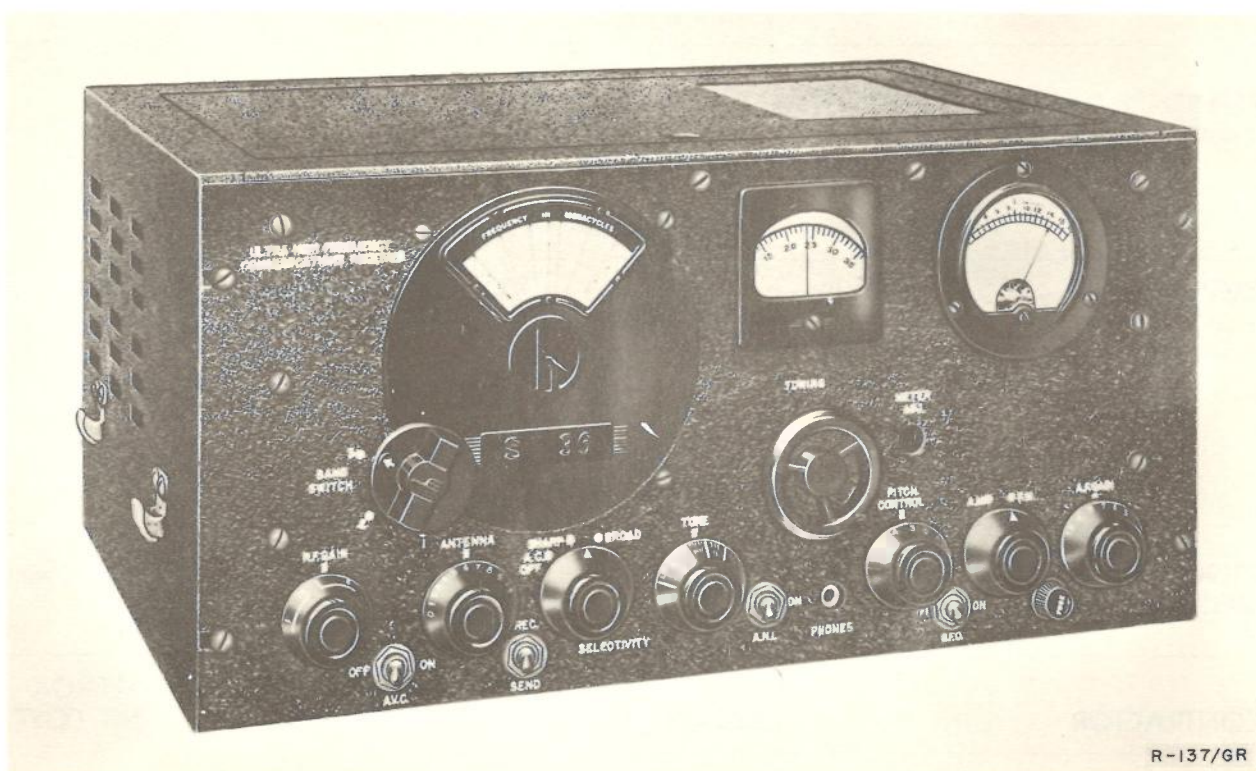

R-137/GR

FUNCTIONAL DESCRIPTION:

Radio Receiver R-137/GR is a transportable, AM (voice, cw) and FM (voice) receiving equipment used for intercept, monitoring, ground to air, and air warning applications in the hf and vhf bands.

This equipment consists essentially of a commercial (Hallicrafter S-36) communications type receiver inclosed in a table model cabinet and requires an external loudspeaker. It is provided with a jack for a headset and an output terminal for loudspeaker operation. It also has manual and automatic volume control and a beat-frequency oscillator.

This set can be operated on 115/230-v ac or from a 6-v battery plus 270 v (at 145 ma) of B battery.

It may be used as a component of Radio Control Central AN/TRQ-1.

TECHNICAL CHARACTERISTICS:

Frequency Range in Mc: 27.8 to 143.0 in 3 bands

Type Modulation: Am, FM

Type of Signal: Voice, cw

Power Requirements: 115/230-v 50/60-cycle ac; or A battery, 4.5 amp at 6-v dc and B battery, 145 ma at 270-v dc

MIL-HDBK-161

AN/GRR-type RADIO RECEIVER

MAJOR COMPONENTS

QTY	ITEM	STOCK NUMBERS	DIMENSIONS (Inches)	WEIGHT (Lbs)
1	Radio Receiver R-137/GR (Equipment consists of only one major component.)	(FSN) 5820-503-1398 (USA) 2C4537-36	19 x 9 x 14	66

REFERENCE DATA AND LITERATURE:

Instruction Book 7610-239-4538

SHIPPING DATA

PKGS	VOLUME (Cu Ft)	WEIGHT (Lbs)
	1.66	

PROCUREMENT DATA

PROCURING SERVICE: USA
SPEC &/or DWG:

DESIGN COG: USA, Sig C

CONTRACTOR	LOCATION	CONTRACT OR ORDER NO.	APPROX UNIT COST
The Hallicrafters Co.	Chicago, Ill.		

MIL-HDBK-161

AN/GRR-type RADIO RECEIVER

MAJOR COMPONENTS

QTY	ITEM	STOCK NUMBERS	DIMENSIONS (Inches)	WEIGHT (Lbs)
		(FSN)		
1	Radio Receiver R-247/URR (Equipment consists of only one major component.)	5820-234-0528	6-31/32 x 19 x 9-1/8	35

REFERENCE DATA AND LITERATURE:

NAVSHIPS 91084

SHIPPING DATA

PKGS	VOLUME (Cu Ft)	WEIGHT (Lbs)
1		40

PROCUREMENT DATA

PROCURING SERVICE: USN
SPEC &/or DWG:

DESIGN COG: USN, BuShips

CONTRACTOR	LOCATION	CONTRACT OR ORDER NO.	APPROX UNIT COST
Lewyt Corp.	Brooklyn, N. Y.	CAA-25755	\$110.00

RADIO RECEIVER **AN/GRR-type**

5 December 1958

Cognizant Serv: **USAF** FSN: 5825-505-0470**R-361C/GR****USA****USN****USAF**

TYPE CLASS: --

Used by

STOCK NO: --

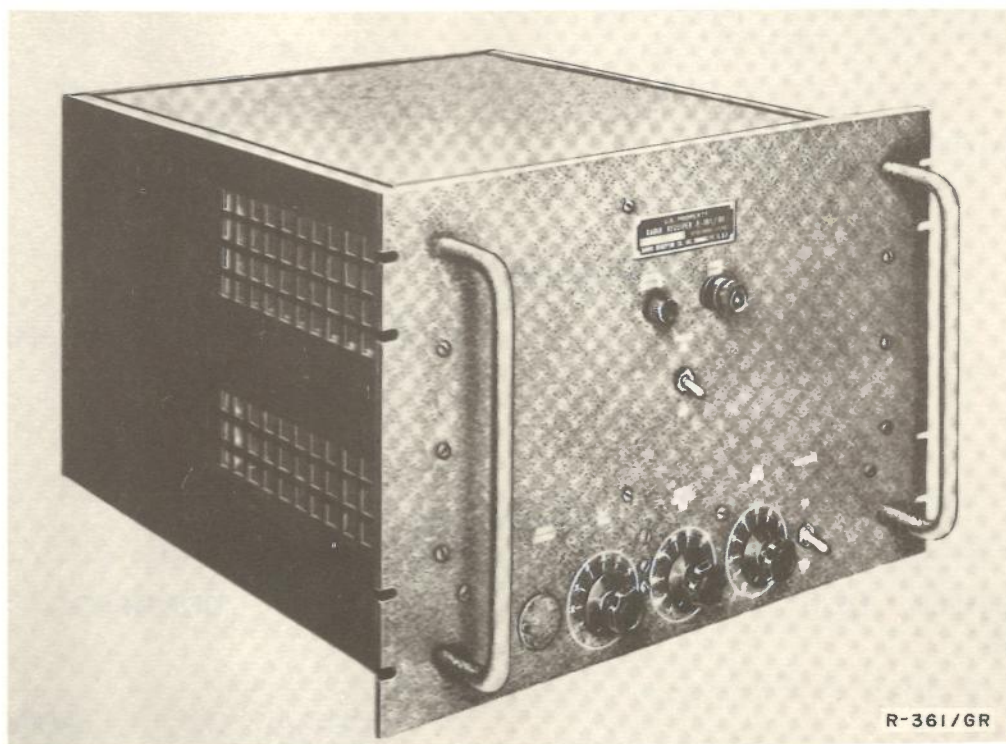
**FUNCTIONAL DESCRIPTION:**

Radio Receiver R-361C/GR is used to receive signals from equipment in aircraft beyond line-of-sight paths. The equipment operates in the frequency range of 225 to 399.9 megacycles and has an output level adequate for operating a loudspeaker of the type used in control towers.

The R-361/GR is similar to Radio Receiver R-361A/GR but has different subassemblies.

TECHNICAL CHARACTERISTICS:

Frequency Range in Mc: 225 to 399.9

Type of Signal: Voice or cw

Channel Spacing: 100 kc

Output Impedance: 600 ohms

Power Requirements: 115-230-v 60-cycle 1-phase ac

MIL-HDBK-161

AN/GRR-type RADIO RECEIVER

MAJOR COMPONENTS

QTY	ITEM	STOCK NUMBERS	DIMENSIONS (Inches)	WEIGHT (Lbs)
-----	------	---------------	------------------------	-----------------

(FSN)

1	Radio Receiver R-361C/GR	5825-505-0470		
---	--------------------------	---------------	--	--

(Equipment consists of only one major component.)

REFERENCE DATA AND LITERATURE:

SHIPPING DATA

PKGS	VOLUME (Cu Ft)	WEIGHT (Lbs)
------	----------------	--------------

PROCUREMENT DATA

PROCURING SERVICE: USAF
SPEC &/or DWG:

DESIGN COG: USAF

CONTRACTOR	LOCATION	CONTRACT OR ORDER NO.	APPROX UNIT COST
------------	----------	--------------------------	---------------------

Federal Television Corp.

Long Island City, N. Y.

RADIO SET AN/GRR-type

1 July 1958

Cognizant Serv: USA FSN: 5820-164-7241

SCR-607-()

USA

USN

USAF

TYPE CLASS: L/Std

--

--

STOCK NO: 2S607

--

--



FUNCTIONAL DESCRIPTION:

Radio Set SCR-607-() is a 3-band, voice and cw, AM and FM, medium- and high-frequency, general purpose radio receiving equipment for fixed station or mobile use in intercept, monitoring, or communication application.

It consists of a commercial type (Hallicrafter S-36) table model communication receiver that can also be mounted on a standard relay rack. It is designed to operate with a special dipole array (Antenna Equipment RC-154) and can be controlled at *standby* from a remote location by means of auxiliary equipment.

This equipment is operated from 115-230-volt ac or from a

6-volt vehicular storage battery plus 270 volts of B battery supply. A shock mount is provided for use when this set is installed and operated in a vehicle.

TECHNICAL CHARACTERISTICS:

Frequency Range in Mc: 27.8 to 143 in 3 band

Type Modulation: AM, FM

Type of Signal: Voice, cw

Power Requirements: 110 w, 115/230-v 50/60-cycle ac; or 4.5 amp at 6-v dc from storage battery, and 145 ma at 270-v dc from B battery

MIL-HDBK-161

AN/GRR-type RADIO SET

MAJOR COMPONENTS

QTY	ITEM	STOCK NUMBERS	DIMENSIONS (Inches)	WEIGHT (Lbs)
1	Antenna Equipment RC-154	(FSN) 5985-243-0107	-----	200
1	Mounting FT-377	(USA) 2Z6721-377	4-7/8 x 21-1/4 x 14-1/2	12
1	Radio Receiver BC-787	(USA) 2C4787	9-5/16 x 21-1/4 x 14-1/2	78

REFERENCE DATA AND LITERATURE:

TM 11-867, TM 11-2631

SHIPPING DATA

PKGS	VOLUME (Cu Ft)	WEIGHT (Lbs)
------	----------------	--------------

PROCUREMENT DATA

PROCURING SERVICE: USA
SPEC &/or DWG: MIL-R-10235

DESIGN COG: USA, Sig C

CONTRACTOR	LOCATION	CONTRACT OR ORDER NO.	APPROX UNIT COST
Electronic Devices, Inc.	Brooklyn, N. Y.	4036-P-46-59	\$ 240.62
The Hallicrafters Co.	Chicago, Ill.	21686-P-50-51	1,074.50
Technical Appliance Corp.	Sherbourne, N. Y.	53321-P-45-59	289.00

RADIO SET AN/GRT-1

1 July 1958

Cognizant Serv: USA FSN: 5820-186-3538

USA

USN

USAF

TYPE CLASS:

STOCK NO:

2S2503-1

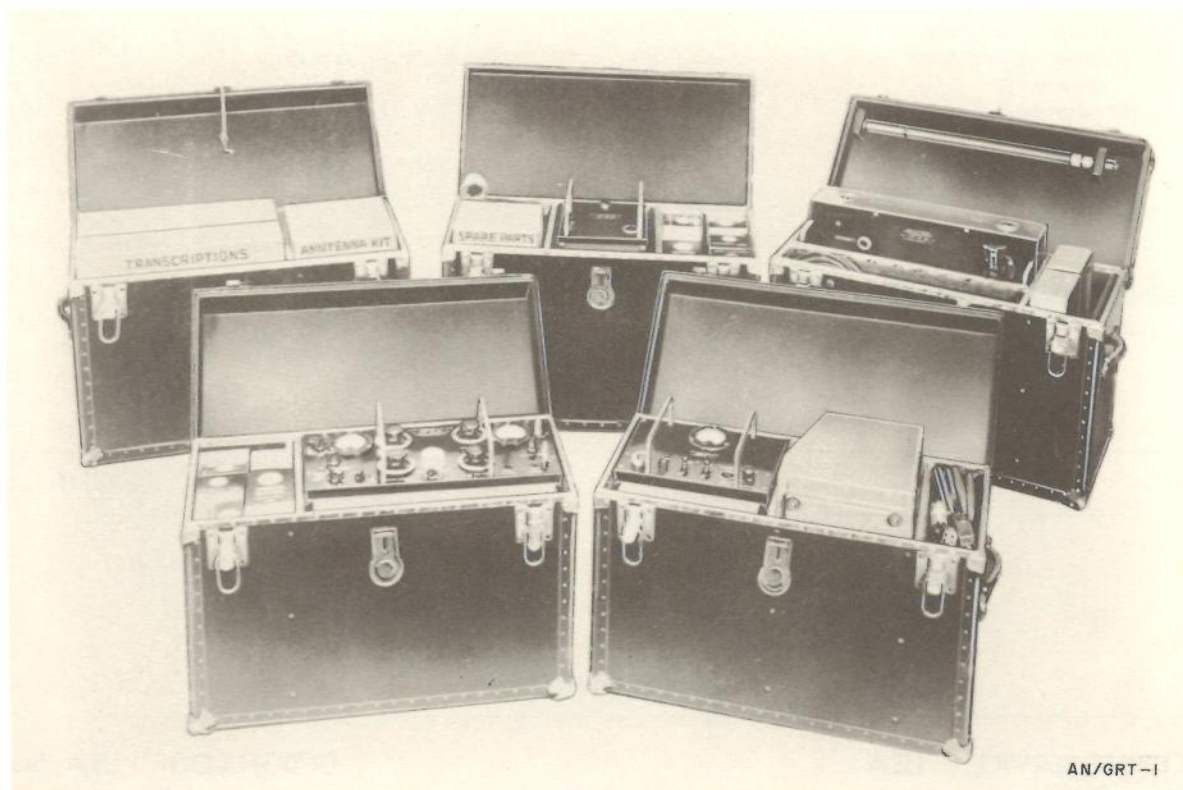

AN/GRT-1

FUNCTIONAL DESCRIPTION:

Radio Set AN/GRT-1 is a portable broadcasting station consisting of a broadcast transmitter, power supply, pressure cooling unit, control console mixer, and a phonograph turntable. It is packed in five armored trunks that serve as carrying cases.

Antenna supports, and suitable control room and studio facilities are required.

TECHNICAL CHARACTERISTICS:

Frequency Range in Mc: 1.1 to 1.5

Type Modulation: AM

Type of Signal: Voice

Power Output: 50 w

Power Requirements: 1,190 w, 90-240-v 50-60-cycle ac

MIL-HDBK-161

AN/ORT-1 RADIO SET

MAJOR COMPONENTS

QTY	ITEM	STOCK NUMBERS	DIMENSIONS (Inches)	WEIGHT (Lbs)
1	Auxiliary antenna kit	-----	12 x 12 x 3	20
1	Control console mixer	-----	11 x 18 x 9-3/8	35
2	Dynamic microphone	-----		
1	Photograph turntable (two-speed)	-----	6-3/4 x 20-1/4 x 18	20
1	Pressure cooling and voltage selector unit	-----	11-7/8 x 9 x 17-7/8	54-1/4
1	Radio broadcast transmitter	-----	11-1/4 x 18-3/4 x 17-7/8	49-1/2
1	Transmitter Power Supply	-----	10-1/2 x 12-1/2 x 16	89-1/4

REFERENCE DATA AND LITERATURE:

TM-11-825

SHIPPING DATA

PKGS	VOLUME (Cu Ft)	WEIGHT (Lbs)
5	----	766

PROCUREMENT DATA

PROCURING SERVICE: USA
SPEC &/or DWG:

DESIGN COG: USA, Sig C

CONTRACTOR	LOCATION	CONTRACT OR ORDER NO.	APPROX UNIT COST
		14961-P-44	

RADIO TRANSMITTING SET AN/GRT-2

26 November 1958

Cognizant Serv: USAF FSN:

	USA	USN	USAF
TYPE CLASS:	--	--	Alt-Std
STOCK NO:	--	--	--

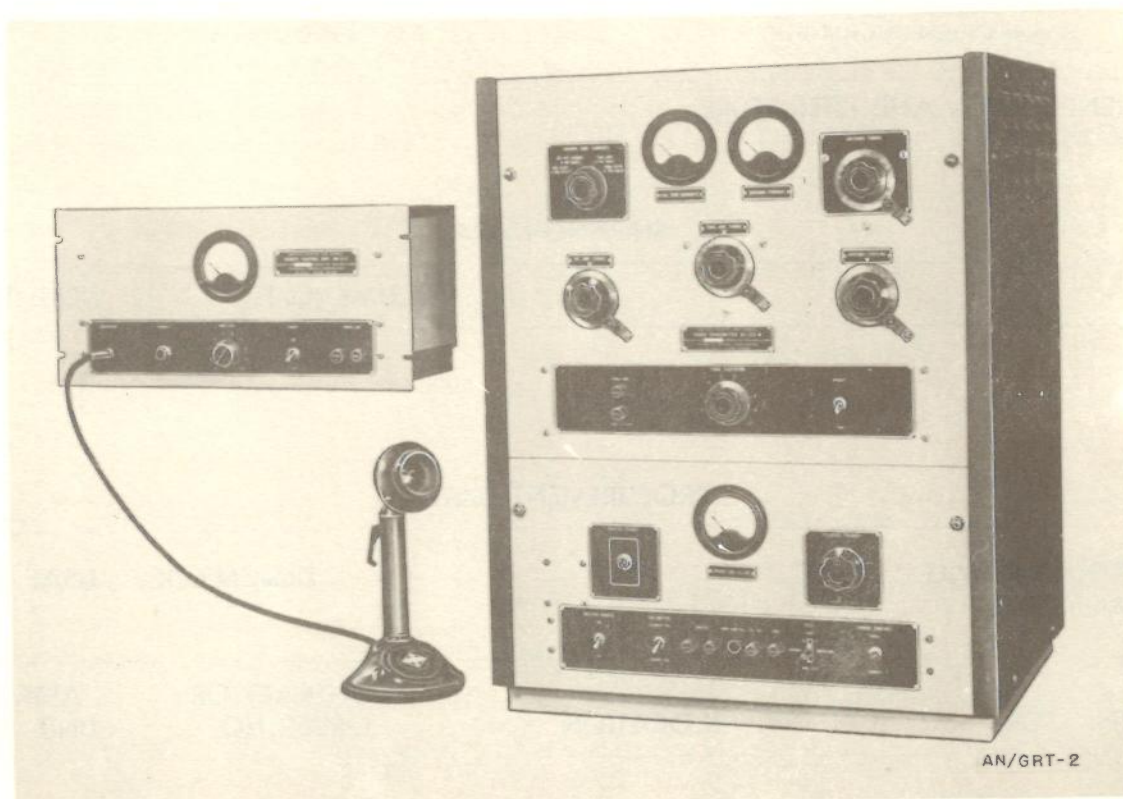
**FUNCTIONAL DESCRIPTION:**

Radio Transmitting Set AN/GRT-2 is a fixed, ground communication equipment designed for short-range airport traffic control. It can be operated from a distance of 5 miles by Remote Control Unit RM-6.

The frequency is crystal controlled, with a master oscillator for emergency operation.

The 500-ohm impedance audio input circuit is designed for

a low-impedance microphone or telephone line. The antenna output is intended to operate into a long wire antenna.

TECHNICAL CHARACTERISTICS:

Frequency Range in Mc: 0.2 to 0.41

Type Modulation: AM

Type Signal: Voice

Power Output: 25 w

Power Requirements: 560 w 105-125-v 50-60-cycle 1-phase ac; an additional 28 w is required for remote control

MIL-HDBK-161

AN/GRT-2 RADIO TRANSMITTING SET

MAJOR COMPONENTS

QTY	ITEM	STOCK NUMBERS	DIMENSIONS (Inches)	WEIGHT (Lbs)
1	Microphone T-27-P	-----	11 x 5-1/4 dia	2.75
1	Radio Transmitter BC-329-N	-----	30-1/2 x 24-1/4 x 20	240
1	Remote Control Unit RM-6-K	-----	8-23/32 x 19 x 10-1/4	36

REFERENCE DATA AND LITERATURE:

TO 16-30FRT2-2, -3

SHIPPING DATA

PKGS	VOLUME (Cu Ft)	WEIGHT (Lbs)
2	25.6	512

PROCUREMENT DATA

PROCURING SERVICE: USAF
SPEC &/or DWG:

DESIGN COG: USAF, RADC

CONTRACTOR	LOCATION	CONTRACT OR ORDER NO.	APPROX UNIT COST
------------	----------	--------------------------	---------------------

RADIO TRANSMITTING SET AN/GRT-3

26 November 1958

Cognizant Serv: USAF FSN:

	USA	USN	USAF
TYPE CLASS:	--	--	Alt-Std
STOCK NO:	--	--	--

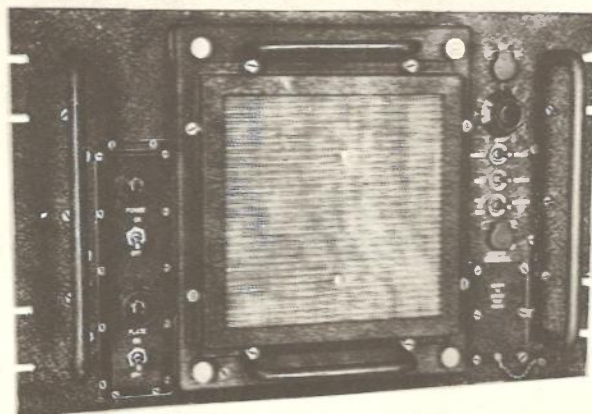

AN/GRT-3

FUNCTIONAL DESCRIPTION:

Radio Transmitting Set AN/GRT-3 is a ground fixed station ultra-high-frequency set designed for ground-to-air and point-to-point communication. It is normally used with Radio Receiving Set AN/GRR-7 to form a two-way communication facility.

The transmitter output circuit is intended to match a 52-ohm coaxial low-impedance transmission line RG-8/U or equivalent.

Recommended antennas are: Antenna AT-197/GR, Antenna AS-505/GR, and Antenna AS-450/GR. On control

tower frequencies, Antenna AT-197/GR is used. On airway frequencies, Antenna AS-505/GR is recommended. No remote control facilities are provided.

TECHNICAL CHARACTERISTICS:

Frequency Range in Mc: 225 to 400

Type Control: Crystal

Type Modulation: AM

Type Signal: Voice

Power Output: 100 w (nominal)

Power Requirements: 750 w, 105-125/210-250-v 60-cycle 1-phase ac

MAJOR COMPONENTS

*QTY	ITEM	STOCK NUMBERS	DIMENSIONS (Inches)	WEIGHT (Lbs)
1	Modulator-Power Supply MD-141/GR	-----	10 x 12-1/4 x 21	200.0
1	Radio Transmitter T-282/GR	-----	19 x 12-1/4 x 21	175.0

REFERENCE DATA AND LITERATURE:

MIL-HDBK-161

AN/GRT-3 RADIO TRANSMITTING SET

SHIPPING DATA

PKGS	VOLUME (Cu Ft)	WEIGHT (Lbs)
4	22.44	600

PROCUREMENT DATA

PROCURING SERVICE: USAF
SPEC &/or DWG: Eng-246

DESIGN COG: USAF, RADC

CONTRACTOR	LOCATION	CONTRACT OR ORDER NO.	APPROX UNIT COST
------------	----------	--------------------------	---------------------

RADIO TRANSMITTER AN/GRT-type

4 December 1958

Cognizant Serv: USA FSN:

BC-191-()

USA

USN

USAF

TYPE CLASS:

Std

Used by

--

STOCK NO:

2C6191

--

--

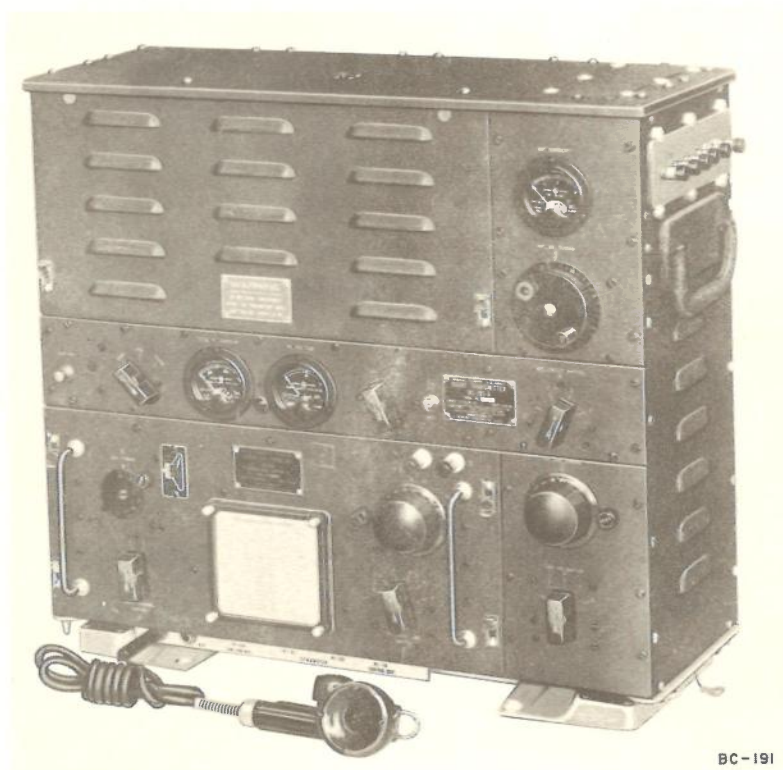

BC-191

FUNCTIONAL DESCRIPTION:

Radio Transmitter BC-191-() is a general utility, medium-range, low-frequency radio transmitting equipment which is widely used as part of Radio Sets SCR-117, SCR-188, SCR-193, and AN/VRC-1 and similar equipment. The sets can be used on the ground, in vehicles, and in aircraft, for ground-to-ground or ground-to-air communication.

This equipment consists of a radio transmitter and appropriate tuning units for the frequency channels in which radio transmitter operation is desired, a dynamotor, and related accessories. Normally, when issued as part of a complete radio set, this equipment is provided with tuning units for the frequencies in which the radio set is to be operated.

Radio Transmitters BC-191-A through -F and BC-191-N

are identical for all operating functions, but vary slightly in mechanical detail.

The transmitter may be operated from a storage battery, through the dynamotor component, or from a portable field power unit such as Power Units PE-75 and PE-49 and similar equipment.

TECHNICAL CHARACTERISTICS:

Frequency Range in Mc: 0.2 to 0.8 and 1.5 to 12.5

Operating Range: Approx 100 miles

Type of Modulation: AM

Type of Signal: Voice, tone, and cw

Power Output: 40 to 75 w

Power Requirements: 12-v storage battery, gasoline engine generator for supplying 12-v and high voltage, or 110- or 220-v 60 cycle ac.

MIL-HDBK-161

AN/GRT-type RADIO TRANSMITTER

MAJOR COMPONENT

QTY	ITEM	STOCK NUMBERS	DIMENSIONS (Inches)	WEIGHT (Lbs)
1	Antenna Tuning Unit BC-306	-----	17-3/4 x 9-1/2 x 9-1/8	9.75
1	Dynamotor Unit BD-77	-----	10-29/32 x 11-1/16 x 7-1/2	38.7
1	Radio Control Box BC-309	-----	3-9/16 x 3-1/2 x 2-7/32	0.418
1	Radio Transmitter BC-191-()	-----	22 x 21-21/32 x 9-5/16	52
8	Transmitter tuning units	-----	7-5/8 x 16-3/4 x 8-3/4	11.437

REFERENCE DATA AND LITERATURE:
TM 11-4017

SHIPPING DATA

PKGS	VOLUME (Cu Ft)	WEIGHT (Lbs)
------	----------------	--------------

PROCUREMENT DATA

PROCURING SERVICE: USA
SPEC &/or DWG:

DESIGN COG: USA, Sig C

CONTRACTOR	LOCATION	CONTRACT OR ORDER NO.	APPROX UNIT COST
------------	----------	--------------------------	---------------------

RADIO TRANSMITTER AN/GRT-type

1 July 1958

Cognizant Serv: USA FSN: 5820-189-7042

BC-610-()

USA

USN

USAF

TYPE CLASS: Std
 STOCK NO: 2C6500

L/Std

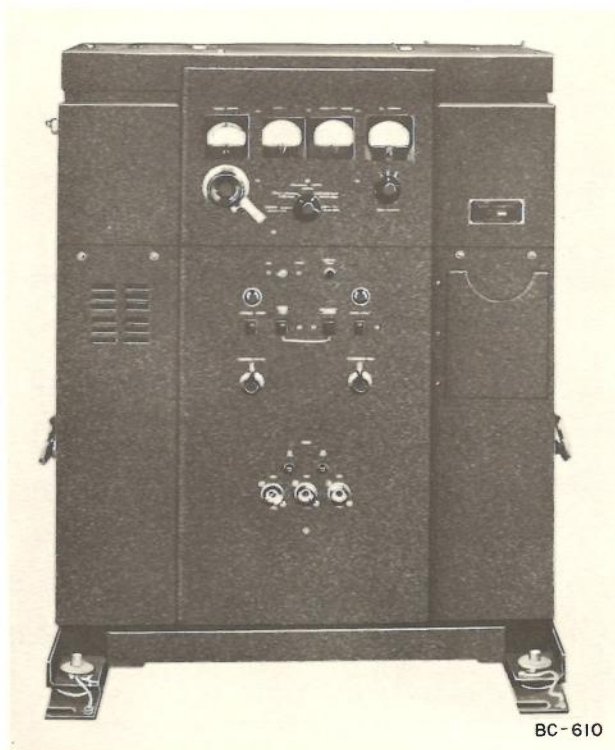

FUNCTIONAL DESCRIPTION:

Radio Transmitter BC-610-() is the widely used radio transmitting component of such equipments as Radio Sets SCR-399, SCR-499, and similar units. It is a crystal-controlled or master oscillator medium- and high-frequency, radiotelegraph equipment used in intermediate and long-distance communication.

With additional equipment (such as Speech Amplifier BC-614-()), this transmitter can furnish an radiotelephone service.

This equipment consists essentially of a single, cabinet-enclosed, compact unit fitted with shock mountings. It is designed for mobile applications, using whip-type antenna systems. With rhombic, doublet, tower-supported or other elaborate antenna arrays, it can be used as a fixed station transmitter.

As mobile equipment it is powered by a trailer-drawn power unit; as fixed station equipment it is operated on conventional power sources.

TECHNICAL CHARACTERISTICS:

Frequency Range in Mc: 2 to 18

Type Modulation: AM

Type of Signal: Cw or voice (with additional equipment)

Power Output:

Cw: 400 w

Voice: 300 w

(Above 8 mc, the output is somewhat less.)

Power Requirements: 1,700 to 2,000 w, 115-v 50/60-cycle ac

MAJOR COMPONENTS

QTY	ITEM	STOCK NUMBERS	DIMENSIONS (Inches)	WEIGHT (Lbs)
		(FSN)		
1	Radio Transmitter BC-610-() (includes complete set of rf tuning units and coils) (Equipment consists of only one major component.)	5820-189-7042	32-5/8 x 21-3/8 x 39-7/8 (includes three rf tuning units and coils from set supplied)	497

MIL-HDBK-161

AN/GRT-type RADIO TRANSMITTER

REFERENCE DATA AND LITERATURE:

TM 11-281, TM 11-826

SHIPPING DATA

PKGS	VOLUME (Cu Ft)	WEIGHT (Lbs)
	35.1	755

PROCUREMENT DATA

PROCURING SERVICE: USA

DESIGN COG: USA, Sig C

SPEC &/or DWG: (USA) 71-3334-(BC-610-I)
(USA) 71-1683-()

CONTRACTOR	LOCATION	CONTRACT OR ORDER NO.	APPROX UNIT COST
David Bogen Co., Inc.	Paramus, N. J.	(BC-610-F) 10970-P-48-77	
George Voron & Co.	Philadelphia, Pa.	(BC-610-H) 25210-P-54-55	\$1,627.22
The Hallicrafter Co.	Chicago, Ill.	(BC-610-I) 3467-P-52-06	1,606.11

RADIO TRANSMITTER AN/GRT-type

1 July 1958

Cognizant Serv: USA FSN: 5820-503-3305

T-417/GR

USA

USN

USAF

TYPE CLASS: Std
 STOCK NO: 2C6900-417

FUNCTIONAL DESCRIPTION:

Radio Transmitter T-417/GR is an FM radio transmitter designed for fixed station use. It is intended for use in system applications to provide point-to-point communication, or radio relay service by retransmission.

This transmitter is not self-sufficient; it relies on other components of the system to provide power and control facilities.

Provision is made for operation on either of two preset crystal-controlled frequencies.

It is used as part of Radio Sets AN/FRC-15 and AN/TRC-22.

TECHNICAL CHARACTERISTICS:

Frequency Range in Mc: 25 to 50

Type Modulation: FM

Type of Signal: Voice

Power Output: 45 w

Power Requirements: Power Supply PP-804/U or equivalent (not supplied as part of this equipment)

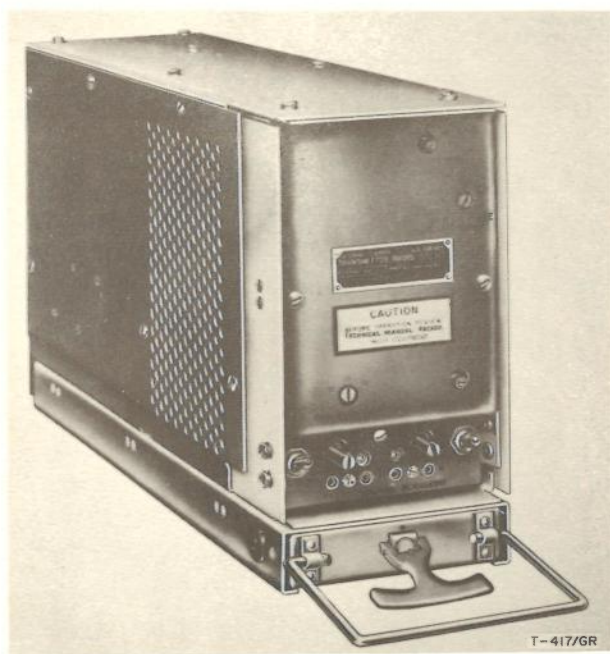

MAJOR COMPONENTS

QTY	ITEM	STOCK NUMBERS	DIMENSIONS (Inches)	WEIGHT (Lbs)
		(FSN)		
1	Radio Transmitter T-417/GR (Equipment consists of only one major component.)	5820-503-3305	8-1/2 x 4-1/2 x 14-1/2	

REFERENCE DATA AND LITERATURE:

TM 11-804

CODE TRAINING SET AN/GSC-T1()

26 November 1958

Cognizant Serv: USA FSN: 6940-243-1972

	USA	USN	USAF
TYPE CLASS:	Std	Used by	Ltd-Std
STOCK NO:	4A401-T1	--	--

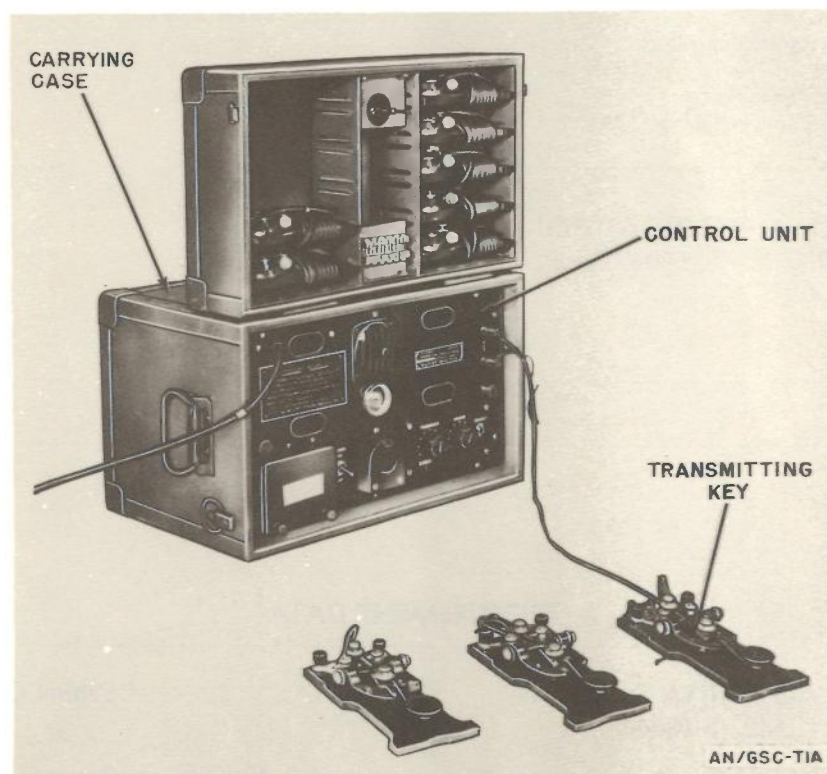
**FUNCTIONAL DESCRIPTION:**

Code Training Set AN/GSC-T1() is a device intended to facilitate student practice of transmission and reception of International Morse Code signals by both visual and audio methods.

This equipment is used at camps, aboard transports, in hospitals, and in rehabilitation centers. It may be operated out of doors.

Practice groups may be placed as far as 40 feet from the equipment, provided the surrounding noise levels do not exceed 60 decibels. It includes 10 telegraph keys which may all be connected to the main unit at one time.

During operation, hand keying produces either an audio tone adjustable in pitch and volume, or a blinker flash visible

to a practice group. The tone is delivered by a loudspeaker and the blinker flash by a 1-watt neon gas lamp.

There are two models of this equipment, Code Training Sets AN/GSC-T1 and AN/GSC-T1A. Both of these items are functionally similar, and differ only in minor electrical details.

TECHNICAL CHARACTERISTICS:*Medium of Communication:*

Audible: 2-1/2 in. permanent magnet loudspeaker

Visual: 1 w neon gas lamp

Frequency of Tone: 600 to 1,000 cps $\pm 20\%$

Sound Range: Approximately 40 ft; with local noise below 60 db noise level

Power Requirements: 6/12/24/115-v dc; or 115/230-v 60-cycle ac

MIL-HDBK-161

AN/GSC-T1() CODE TRAINING SET

MAJOR COMPONENTS

QTY	ITEM	STOCK NUMBERS	DIMENSIONS (Inches)	WEIGHT (Lbs)
1	Code Training Set AN/GSC-T1() including:			
1	Control unit	-----	13-1/4 x 18 x 11	52.0
1	Power cord and auxiliary cord	-----	96 lg	1.8
10	Transmitting keys	-----	1-1/2 x 3 x 6	1.9
10	Transmitting key cords	-----	120 lg	0.5

REFERENCE DATA AND LITERATURE:

TM 11-437; TM 11-437A; TO 28-30GSCT1-6

SHIPPING DATA

PKGS	VOLUME (Cu Ft)	WEIGHT (Lbs)
1	5.1	76

PROCUREMENT DATA

PROCURING SERVICE: USA
SPEC &/or DWG: MIL-T-13660

DESIGN COG: USA, Sig C

CONTRACTOR	LOCATION	CONTRACT OR ORDER NO.	APPROX UNIT COST
------------	----------	--------------------------	---------------------

TELEPHONE REPEATER **AN/GTA-type**

1 July 1958

Cognizant Serv: USA FSN: 5805-221-4817

TA-126/GT

	USA	USN	USAF
TYPE CLASS:	Std	--	Std
STOCK NO:	4B3186-126	--	--

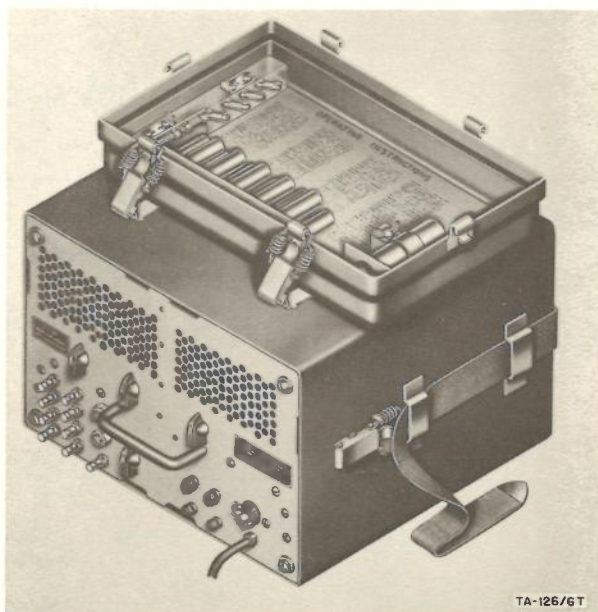
**FUNCTIONAL DESCRIPTION:**

Telephone Repeater TA-126/GT is a portable, single-channel, terminal-type equipment that provides stable, low-loss, short-haul telephone circuits in point-to-point, loop, and local trunk circuits. It is used in field wire systems to improve transmission under all weather conditions.

The equipment passes 20 cycle or vf signaling. It may be used with field telephones, field switchboards, telephone and telegraph apparatus, multichannel telegraph terminals, and data transmission equipment.

TECHNICAL CHARACTERISTICS:

Facilities Required: Two-wire or four-wire field telephone lines

Facilities Provided: Two-wire or four-wire operation; low-loss telephone circuits over poor quality lines

Frequency: 200 to 6,500 cps

Power Requirements: 1 amp 115-v ($\pm 10\%$) 50/60-cycle ac;
4 amp 22-30-v dc

MAJOR COMPONENTS

QTY	ITEM	STOCK NUMBERS	DIMENSIONS (Inches)	WEIGHT (Lbs)
		(FSN)		
1	Telephone Repeater TA-126/GT (Equipment consists of only one major component.)	5805-221-4817	11-5/8 x 15-7/8 x 16-1/2	65

REFERENCE DATA AND LITERATURE:

TM 11-2135

MIL-HDBK-161

AN/GTA-type TELEPHONE REPEATER

SHIPPING DATA

PKGS	VOLUME (Cu Ft)	WEIGHT (Lbs)
1	3.13	75

PROCUREMENT DATA

PROCURING SERVICE: USA
SPEC &/or DWG: MIL-T-11004

DESIGN COG: USA, Sig C

CONTRACTOR	LOCATION	CONTRACT OR ORDER NO.	APPROX UNIT COST
Lenkurt Electric Co., Inc.	San Carlos, Calif.	14203-P-51-03	\$1,326.00

TELEPHONE REPEATER **AN/GTC-type**

1 July 1958

Cognizant Serv: USA FSN: 5805-164-7065

TP-14

USA

USN

USAF

TYPE CLASS:

Std

STOCK NO:

4B3250-14



TP-14

FUNCTIONAL DESCRIPTION:

Telephone Repeater TP-14 is a portable, field, 22-type repeater equipment used to extend the range of two-wire (open-wire or field cable) facilities.

This equipment consists of a completely self-contained unit including the amplifier, filters, equalizers, line-balancing networks, and related items. It is a panel-mounted apparatus contained in a protective box or case, and can be removed from its housing for rack-and-panel mounting in fixed-station applications.

Two of these repeaters may be used in tandem to extend

circuits where mixed facilities, such as open-wire and field cable, are used, and can be installed at terminal or intermediate points of a system.

TECHNICAL CHARACTERISTICS:

Number and Type of Facilities: Four-wire to four-wire amplification or two-wire to four-wire amplification or four-wire to two-wire amplification

Power Requirements: 11 w 110-130/220-250-v 50/60-cycle ac; or 800 ma at 12-v dc from storage battery; or 20 ma at 135-v dc from dry cells and 150 ma at 12-v dc from storage battery

MIL-HDBK-161

AN/GTC-type TELEPHONE REPEATER

MAJOR COMPONENTS

QTY	ITEM	STOCK NUMBERS	DIMENSIONS (Inches)	WEIGHT (Lbs)
		(FSN)		
1	Telephone Repeater TP-14 (Equipment consists of only one major component.)	5805-164-7065	17-1/2 x 11 x 8	

REFERENCE DATA AND LITERATURE:

TM 11-2007

SHIPPING DATA

PKGS	VOLUME (Cu Ft)	WEIGHT (Lbs)
------	----------------	--------------

PROCUREMENT DATA

PROCURING SERVICE: USA
SPEC &/or DWG: MIL-R-13215B

DESIGN COG: USA, Sig C

CONTRACTOR	LOCATION	CONTRACT OR ORDER NO.	APPROX UNIT COST
General Development Corp.	Trenton, N. J.	3567-P-52-03	\$590.00

TONE WARNING GENERATOR GROUP **AN/GTT-type**

1 July 1958

Cognizant Serv: USA FSN:

OA-145/GT

USA

USN

USAF

TYPE CLASS: Std

--

--

STOCK NO:

--

--

--

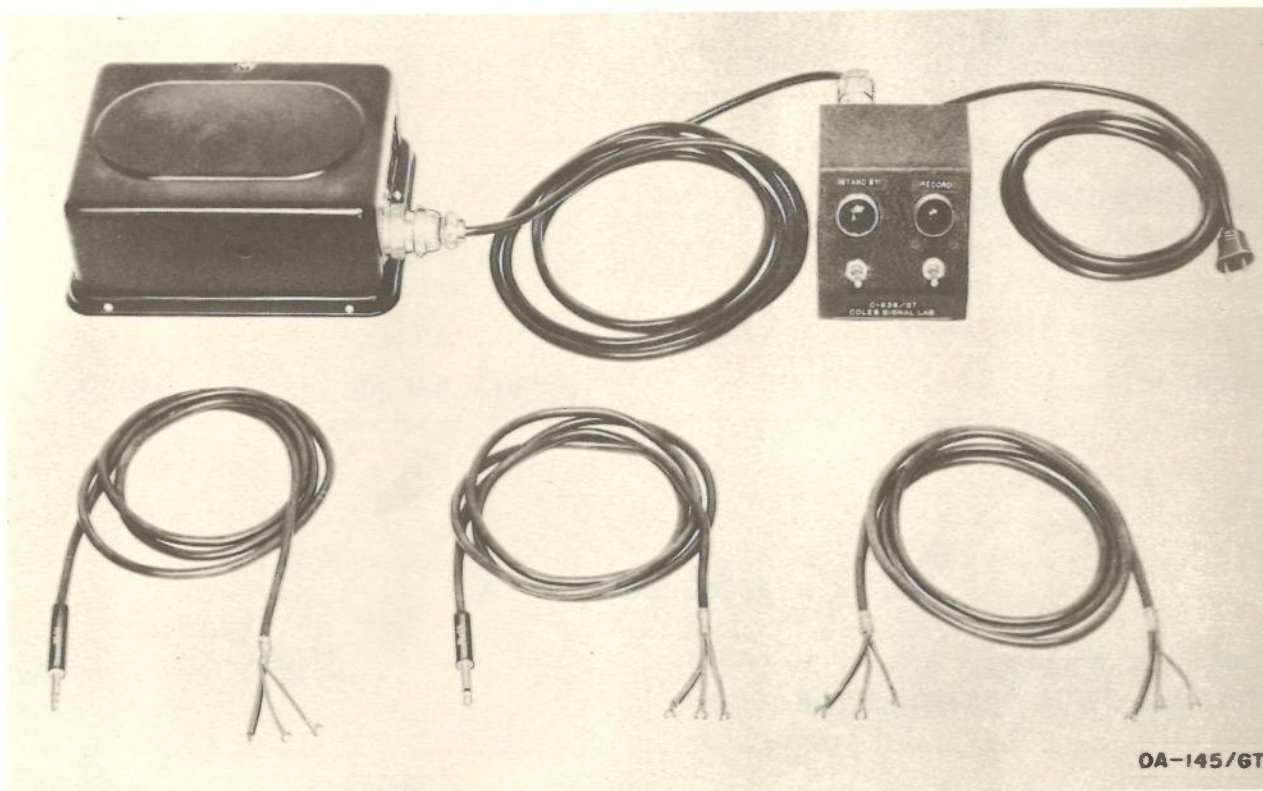
**FUNCTIONAL DESCRIPTION:**

Tone Warning Generator Group OA-145/GT is used on telephone lines to give audible indication that the telephone conversation is being recorded.

This equipment consists essentially of a tone-warning generator, controls, and accessories.

Three special purpose cable assemblies are supplied with this equipment for flexibility in connection to most standard recorders.

The warning signal is applied to the line at intervals of 15 seconds, which complies with the requirements of the Federal Communication Commission for use on commercial telephone lines.

TECHNICAL CHARACTERISTICS:

Type of Signal: 1,400-cps tone of 0.2 second duration, 15 second interval

Power Requirements: 115-v 50/60-cycle ac

MIL-HDBK-161

AN/GTT-type TONE WARNING GENERATOR GROUP

MAJOR COMPONENTS

QTY	ITEM	STOCK NUMBERS (FSN)	DIMENSIONS (Inches)	WEIGHT (Lbs)
1	Tone Warning Generator Control C-638/GT	6110-228-3132	3-15/16 x 4 x 4-1/2	0.5
1	Tone Warning Generator O-93/GT	5895-242-3145	9-3/4 x 6-5/8 x 4-1/32	1.5

REFERENCE DATA AND LITERATURE:

TM 11-2088

SHIPPING DATA

PKGS	VOLUME (Cu Ft)	WEIGHT (Lbs)
1	2	35

PROCUREMENT DATA

PROCURING SERVICE: USA
SPEC &/or DWG: (USA)71-3370 & 71-3412

DESIGN COG: USA, Sig C

CONTRACTOR	LOCATION	CONTRACT OR ORDER NO.	APPROX UNIT COST
------------	----------	--------------------------	---------------------

RECORDER **AN/GXR-type**

20 November 1958

Cognizant Serv: USA FSN:

RD-2/GXR

USA

USN

USAF

TYPE CLASS:

Std

Used by

--

STOCK NO:

6C262-2

--

--

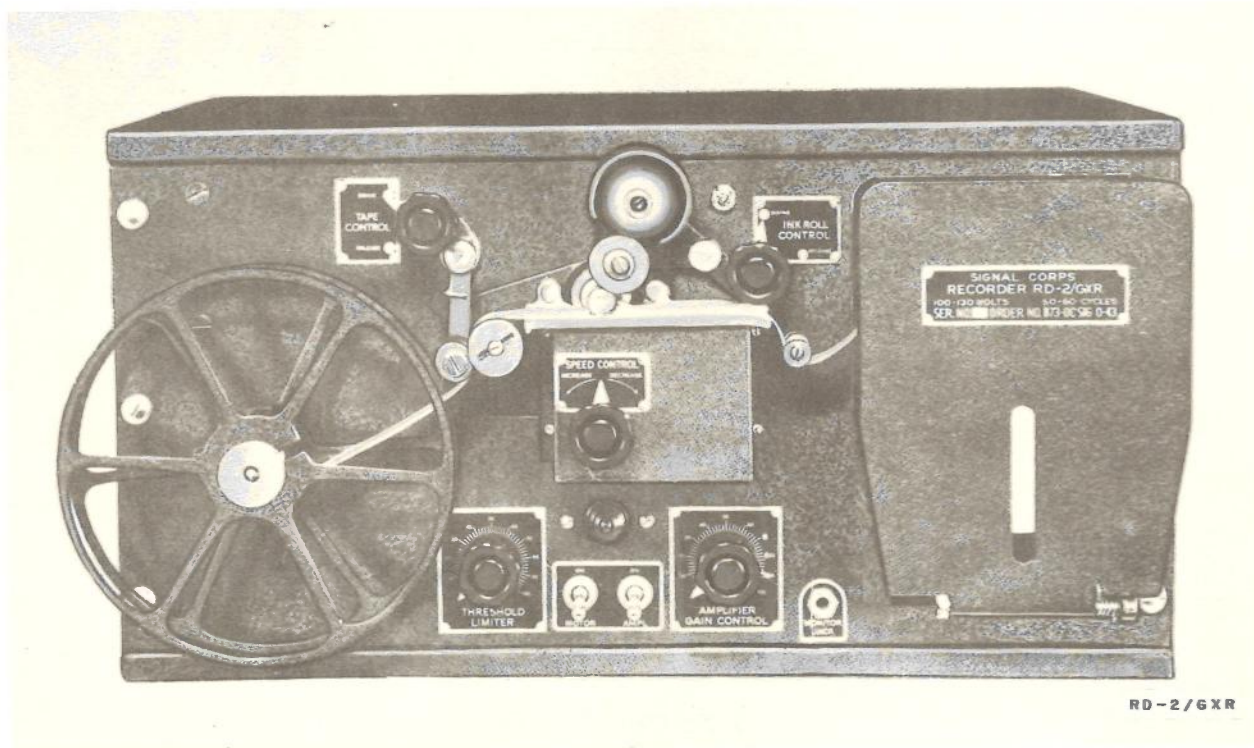
**FUNCTIONAL DESCRIPTION:**

Recorder RD-2/GXR is a cabinet or rack mounted facsimile recorder. It records printed or typed messages on 3/4-inch paper tape from facsimile signals received on an ordinary radio receiver or from a wire line. These signals consist of seven mark or space impulses per line, and seven lines per character. The recorder is a self-contained unit only requiring connection to a power line and a source of signal to its input

terminals. It is capable of recording printed messages at varying speeds up to 84 words per minute.

TECHNICAL CHARACTERISTICS:

Signal Input: Special facsimile signal (7X7) -3 db to +27 db

Input Impedance: 600 ohms at 1,000 cps

Recording Speed: 25 to 85 wpm

Tape Speed: Variable, with maximum of 54, 60, or 72 inches per minute, depending upon selection of interchangeable speed-control rollers

Power Requirements: 150 w 100-130-v 50-60-cycle ac

MIL-HDBK-161

AN/GXR-type RECORDER

MAJOR COMPONENTS

QTY	ITEM	STOCK NUMBERS	DIMENSIONS (Inches)	WEIGHT (Lbs)
1	Recorder RD-2/GXR (cabinet mount)	-----	10-1/8 x 14-5/8 x 19-1/4	75
1	Chest CX-65/GXR	-----	13-1/2 x 19-1/2 x 29	40

REFERENCE DATA AND LITERATURE:
TM 11-382

SHIPPING DATA

PKGS	VOLUME (Cu Ft)	WEIGHT (Lbs)
1	4.7	125

EMENT DATA

PROCURING SERVICE: USA
SPEC &/or DWG:

DESIGN COG: USA, Sig C

CONTRACTOR	LOCATION	CONTRACT OR ORDER NO.	APPROX UNIT COST
------------	----------	--------------------------	---------------------

TELETYPEWRITER **AN/MGC-type**

1 July 1958
Cognizant Serv: **USA** FSN: **5815-198-4442**

TT-55/MGC

	USA	USN	USAF
TYPE CLASS:	Std	--	--
STOCK NO:	4TTT55	--	--

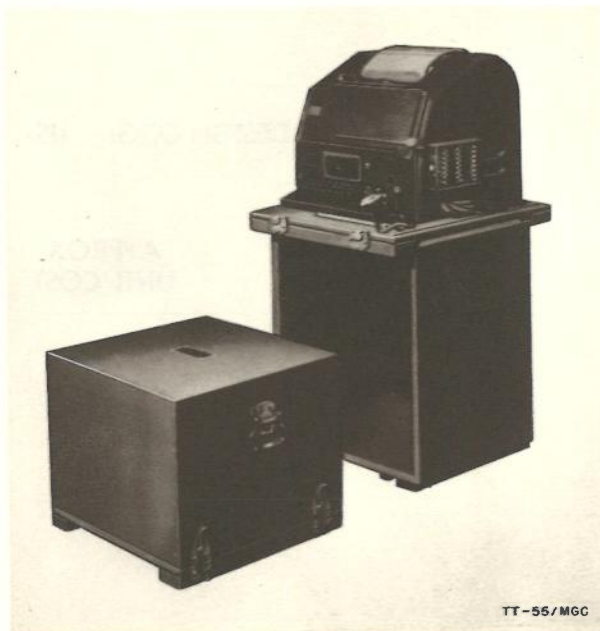

FUNCTIONAL DESCRIPTION:

Teletypewriter TT-55/MGC is a field, page-printing, teletypewriter equipment designed for installation in field-type shelters or vans for mobile station use in standard communication applications.

This equipment consists essentially of a modified commercial (Teletype Corp. Model 15) teletypewriter station equipment. It has a standard communication keyboard and type pallets and includes a base, motor unit, keyboard transmitter and typing unit, and related accessories. It can be operated in half-duplex operation only.

The cases illustrated above are used to transport the equipment alone. They generally are not included when this equipment is installed in a van or shelter for mobile applications.

TECHNICAL CHARACTERISTICS:

Operating Speed: 368.1 opm (60 wpm)

Motor Characteristics: Series governed; 87.6 vps tuning-fork adjustable; 1,800 rpm speed

Power Requirements: 110 w 115-v dc; 140-wa, 115-v 25/50/60-cycle ac

MAJOR COMPONENTS

QTY	ITEM	STOCK NUMBERS	DIMENSIONS (Inches)	WEIGHT (Lbs)
		(FSN)		
1	Teletypewriter TT-55/MGC (Equipment consists of only one major component.)	5815-198-4442	-----	225

REFERENCE DATA AND LITERATURE:

TM 11-352

MIL-HDBK-161

AN/MGC-type TELETYPEWRITER

SHIPPING DATA

PKGS	VOLUME (Cu Ft)	WEIGHT (Lbs)
3	42	557

PROCUREMENT DATA

PROCURING SERVICE: USA
SPEC &/or DWG: (USA) 71-3334

DESIGN COG: USA

CONTRACTOR	LOCATION	CONTRACT OR ORDER NO.	APPROX UNIT COST
Teletype Corp.	Chicago, Ill.		

1 July 1958

Cognizant Serv: USA FSN: 5820-193-7118

USA

USN

USAF

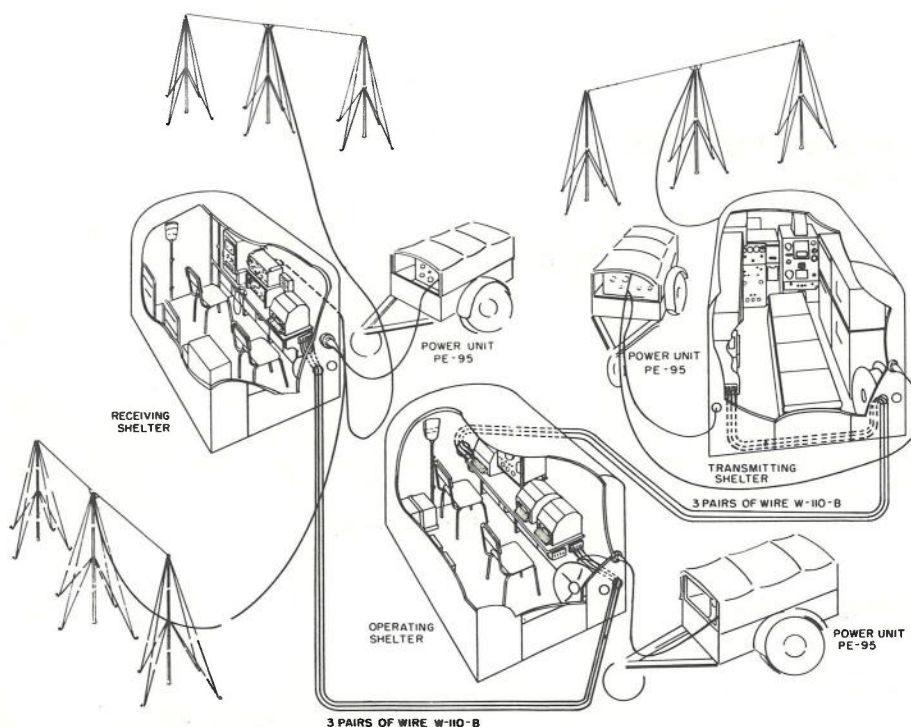
TYPE CLASS:
STOCK NO:Std
2S3007-2

AN/MRC-2

FUNCTIONAL DESCRIPTION:

Radio Set AN/MRC-2() is a 2-kw mobile radioteletype station designed to provide either net or long-distance operation, with provision for fsk radioteletype communication. It is used at field headquarters of large units for long-range communication and for handling a heavy volume of traffic.

This equipment is installed and operated in three Shelters HO-17, each carried on a 2-1/2 ton, 6 x 6 cargo truck. Each truck has a 6-kw trailer-drawn power unit. One shelter houses the transmitting equipment, another carries the receiving equipment, and the third carries the teletypewriter equipment. An additional truck may be provided to transport the antenna masts and accessories.

The transmitter operates into one coaxially-fed doublet antenna. The receiver operated with two coaxially-fed doublet antennas spaced three wavelengths apart for diversity reception.

In addition to fsk radioteletype, it is possible to transmit cw at 2 kw, and voice or cw at 300 w or 400 w, respectively.

TECHNICAL CHARACTERISTICS:*Frequency Range in Mc:*

Transmitter: 2 to 18

Receiver: 1.5 to 18 in 6 bands

Type Modulation: AM*Type of Signal:* Fsk radioteletype, cw, voice*Power Output:*

Voice: 300 w

Fsk or cw: 2 kw 400 w

Power Requirements:

Transmitter: 6.5 kw 115-v 60-cycle ac

Receiver: 2.5 kw 115-v 60-cycle ac

Operating: 2 kw 115-v 60-cycle ac

MIL-HDBK-161

AN/MRC-2() RADIO SET

MAJOR COMPONENTS

QTY	ITEM	STOCK NUMBERS	DIMENSIONS (Inches)	WEIGHT (Lbs)
1	Power Unit PE-75	-----	56 x 44 x 39	491
3	Power Unit PE-95	-----	76-1/2 x 108 x 76-1/2	4,965
1	Shelter HO-17, Operating	-----	158 x 90-1/2 x 77	7,200
1	Shelter HO-17, Receiving	-----	158 x 90-1/2 x 77	7,200
1	Shelter HO-17, Transmitting	-----	158 x 90-1/2 x 77	8,800

REFERENCE DATA AND LITERATURE:

TM 11-624, TO 16-30MRC2-7

SHIPPING DATA

PKGS	VOLUME (Cu Ft)	WEIGHT (Lbs)
9	3,057	39,416

PROCUREMENT DATA

PROCURING SERVICE: USA
SPEC &/or DWG:

DESIGN COG: USA, Sig C

CONTRACTOR	LOCATION	CONTRACT OR ORDER NO.	APPROX UNIT COST
Baker & Williamson, Inc.	Upper Darby, Pa.	3135-P-51-31	\$27,782.85
The Hallicrafters Co.	Chicago, Ill.	3135-P-51-06	27,006.47

RADIO SET AN/MRC-5C

26 November 1958

Cognizant Serv: USN FSN: 5820-665-3873

USA

USN

USAF

TYPE CLASS: --

Used by --

STOCK NO: --

F16-Q-114345-200 --

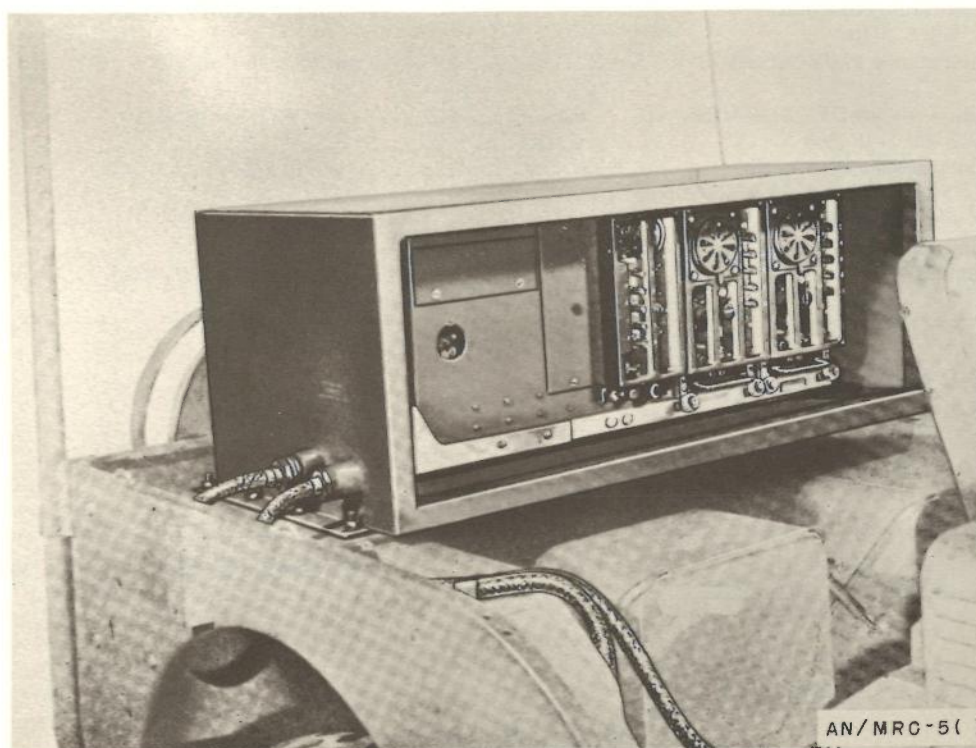

AN/MRC-5()

FUNCTIONAL DESCRIPTION:

Radio Set AN/MRC-5C is a complete mobile radio station designed for short-range ground communication in field and internal security operations. It consists essentially of Radio Set SCR-608 installed in a type M-38, 1/4-tone vehicle.

Headset reception and push-to-talk transmission are possible at the local radio set control. The remote radio set control may be located as far as 1 mile from the vehicle. The local radio set control also provides loudspeaker reception and on-off power control of the set.

The set is submersion proof.

Radio Set AN/MRC-5C is similar to Radio Set AN/MRC-6C, except that the AN/MRC-6C consists of a Truck M-38 and a Radio Transmitting and Receiving Equipment TCS.

TECHNICAL CHARACTERISTICS:*Transmitter:*

Frequency Range in Mc: 27 to 38.9
Number of Preset Channels: 10

Frequency Control: Crystal

Type of Signal: Voice

Type Modulation: FM

Operational Range: 5 to 15 miles

Power Output: 20 w

Receiver:

Type: Superheterodyne

Frequency Control: 10 preset channels or continuous manual tuning

Type Reception: FM

Intermediate Frequency: 2.65 mc

Bandwidth: 80 kc

Sensitivity: 1 uv

Output: 2 w to speaker; 0.2 w to headset

Antenna: 10 ft whip

Power Requirements: 24-v dc vehicular battery

MIL-HDBK-161

AN/MRC-5C RADIO SET

MAJOR COMPONENTS

QTY	ITEM	STOCK NUMBERS	DIMENSIONS (Inches)	WEIGHT (Lbs)
1	Antenna Mast Base Bracket 16-B-750001-368	-----	5-3/4 x 5-1/2 x 12-1/2	6.6
1	Local Radio Set Control C-1217/MRC	-----	7-1/4 x 10-5/8 x 8-3/4	
1	Maintenance Parts Cabinet CY-732/MRC	-----	8-7/8 x 30 x 15-1/2	41
1	Radio Cabinet CY-731A/MRC	-----	17 x 44-5/8 x 18-11/16	
1	Radio Set SCR-608	-----		181
1	Remote Radio Set Control C-1226/MRC	-----	1-9/16 x 3-3/16 x 4-7/8	
1	Set of cables, brackets, plates and hardware			
1	Truck M-38	-----	67-1/4 x 62 x 132-15/16	

REFERENCE DATA AND LITERATURE:

NAVSHIPS 91811

SHIPPING DATA

PKGS	VOLUME (Cu Ft)	WEIGHT (Lbs)
------	----------------	--------------

PROCUREMENT DATA

PROCURING SERVICE: USN

DESIGN COG: USN, BuShips

SPEC &/or DWG:

CONTRACTOR	LOCATION	CONTRACT OR ORDER NO.	APPROX UNIT COST
Waterproof Electric Co.	Burbank, California	NObsr-52593, 12 June 1951	

RADIO SET AN/MRC-6, -6A, -6B

26 November 1958

Cognizant Serv: USN FSN: 5820-665-1348 (AN/MRC-6B)

USA

USN

USAF

TYPE CLASS: --

Used by --

STOCK NO: --

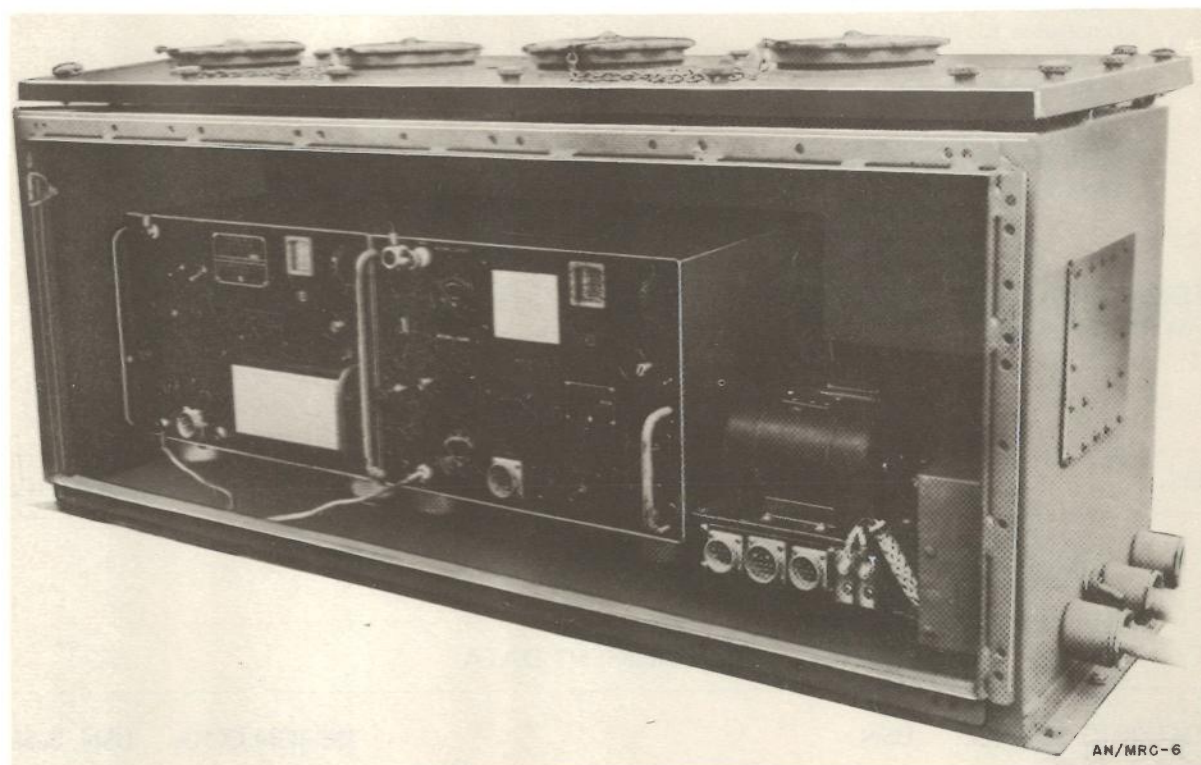
**FUNCTIONAL DESCRIPTION:**

Radio Sets AN/MRC-6, AN/MRC-6A, and AN/MRC-6B are mobile communications equipments for internal security and field use. They consist primarily of a 1/4-ton truck, Radio Transmitting and Receiving equipment TCS (or similar), submersible cabinet, a remote control unit, and accessories.

Radio Sets AN/MRC-6, AN/MRC-6A, and AN/MRC-6B are functionally similar although components and type number vary. The AN/MRC-6A and AN/MRC-6B use Radio Transmitter-Receiver Assembly OA-26A/MRC in place of the TCS. The AN/MRC-6B includes an additional power generator operating off the vehicle engine and 2 additional storage batteries.

TECHNICAL CHARACTERISTICS:*Frequency Range:*

Band 1: 1.5 mc to 3 mc

Band 2: 3 mc to 6 mc

Band 3: 6 mc to 12 mc

Type Modulation: AM*Type Signal:* Cw, voice*Power Output:*

Transmitter: 25 w cw; 10 w voice

Receiver: 2.5 w audio

Power Requirements: 24-v dc from vehicular storage battery

MIL-HDBK-161

AN/MRC-6, -6A, -6B RADIO SET

MAJOR COMPONENTS

QTY	ITEM	STOCK NUMBERS	DIMENSIONS (Inches)	WEIGHT (Lbs)
<i>For AN/MRC-6B:</i>				
2	Battery BB-221/U	-----	10-5/8 x 7-7/8 x 12-11/16	30
1	Installation Kit MX-566A/ MRC	-----		
1	Power Supply Kit MX- 736A/MR	-----	-----	137
1	Radio Transmitter-Receiver Assembly OA-26A/MRC-6			
1	Truck V-35/U			

REFERENCE DATA AND LITERATURE:

NAVSHIPS 91308, 95319

SHIPPING DATA

PKGS	VOLUME (Cu Ft)	WEIGHT (Lbs)
------	----------------	--------------

PROCUREMENT DATA

PROCURING SERVICE: USN
SPEC &/or DWG:

DESIGN COG: USN, BuShips

CONTRACTOR	LOCATION	CONTRACT OR ORDER NO.	APPROX UNIT COST
------------	----------	--------------------------	---------------------

26 November 1958

Cognizant Serv: USN FSN: 5820-644-0934
5820-665-1348(USN)

USA

USN

USAF

TYPE CLASS: --
STOCK NO: --

Used by --

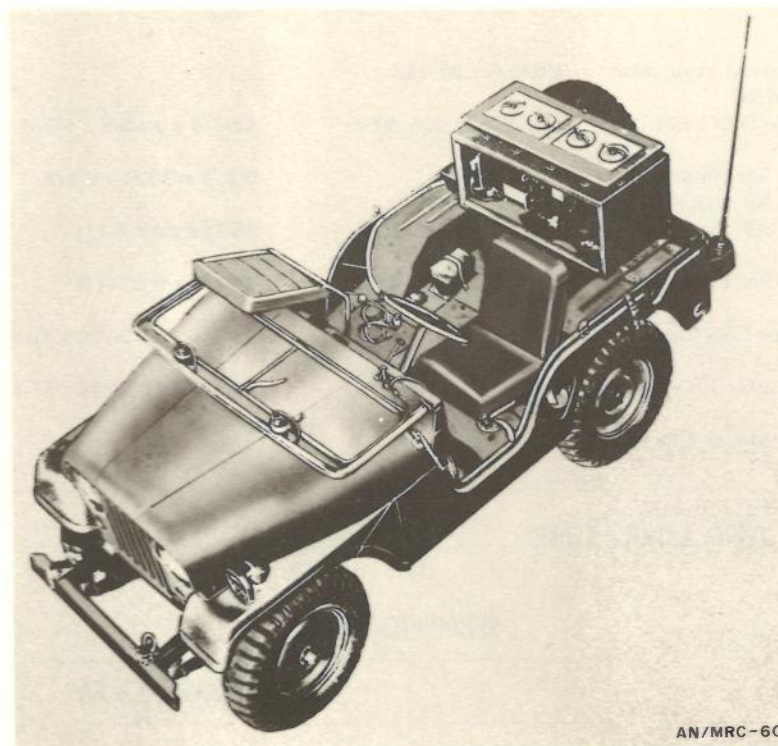

AN/MRC-6C

FUNCTIONAL DESCRIPTION:

Radio Set AN/MRC-6C is a mobile transmitting and receiving equipment installed in a 1/4-ton Ordnance Truck, model M38A1. It is designed for either continuous wave or voice modulated transmission and reception within the frequency range of the set.

The type of emission may be selected by means of a switch located on the front panel of the transmitter unit. The receiver and transmitter units are rigidly constructed to give a high degree of frequency stability.

The vehicle is equipped with an extended exhaust and intake and other waterproofing features to provide for deep water fording.

TECHNICAL CHARACTERISTICS:*Frequency Range:*

Band 1: 1.5 mc to 3 mc

Band 2: 3 mc to 6 mc

Band 3: 6 mc to 12 mc

Type of Signal: Voice or cw*Type Modulation:* AM*Operational Range:*

Voice: 15 miles

Cw: 30 miles

Transmitter Power Output:

Voice: 10 w

Cw: 25 w

Type Tuning: Master oscillator or crystal*Antenna:* Whip type*Power Requirements:* 24-v dc from vehicular storage batteries

MIL-HDBK-161

AN/MRC-6C RADIO SET

MAJOR COMPONENTS

QTY	ITEM	STOCK NUMBERS	DIMENSIONS (Inches)	WEIGHT (Lbs)
3	Battery BA-30	(FSN) 6135-120-1020		
1	Cabinet, Electrical Equipment CY-731A/MRC	(FSN) 5975-575-6286	42-7/8 x 20-1/2 x 17-1/8	
	or			
1	Cabinet, Electrical Equipment CY-1425/MRC	(USA) 6F290-1425		
1	Control, Radio Set C-614/ MRC	(FSN) 5820-265-8093	12-1/4 x 10-7/8 x 8-3/8	
1	Control Unit, Transmitter USN Type No. 23398	(USA) 2C718	5-1/4 x 3-3/4 x 2-1/2	
1	Dynamotor USN Type No. 21330A	(FSN) 6125-635-5442	13-1/4 x 9 x 9-1/4	
1	Dynamotor USN Type No. 21330B	(FSN) 6125-635-5441	13-1/4 x 9 x 9-1/4	
1	Radio Receiver USN Type No. 46159	(FSN) 5820-163-1695	13-3/4 x 11-13/16 x 11-11/16	
1	Radio Transmitter USN Type No. 52245	(FSN) 5820-164-8115	14-3/8 x 11-13/16 x 11-11/16	
1	Utility Truck Model M38A1			

REFERENCE DATA AND LITERATURE:

NAVSHIPS 900.705

SHIPPING DATA

PKGS VOLUME (Cu Ft) WEIGHT (Lbs)

PROCUREMENT DATA

PROCURING SERVICE: USN
SPEC &/or DWG:

DESIGN COG: USN

CONTRACTOR LOCATION CONTRACT OR ORDER NO. APPROX UNIT COST

RADIO SET AN/MRC-13()

26 November 1958

Cognizant Serv: USN FSN:

USA

USN

USAF

TYPE CLASS:
STOCK NO:

Used by

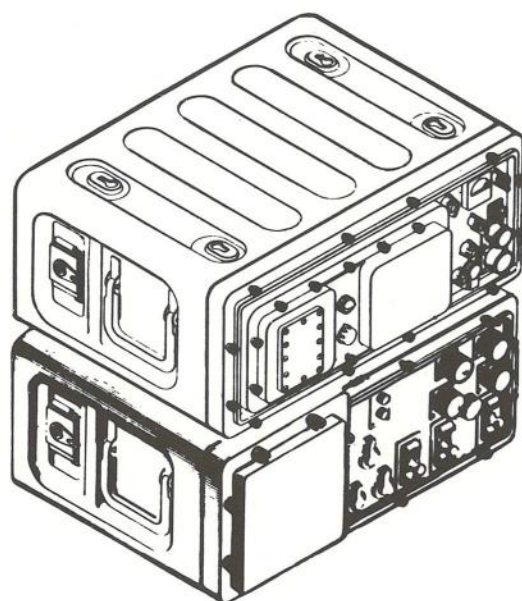

AN/MRC-13()

FUNCTIONAL DESCRIPTION:

Radio Set AN/MRC-13() is a general service, mobile, medium-range, amplitude-modulated unit used for ultra-high-frequency communication with aircraft, ships, and mobile field units.

This equipment consists essentially of VHF Radio Transmitting and Receiving Equipment MAR, which is mounted in a truck. It is similar to Radio Set AN/MRC-12() except that the latter includes a standby receiver (Portable Radio Receiving Equipment RDR).

The models of this equipment differ primarily in the type of vehicle in which they are installed. The AN/MRC-13 is installed in Truck NT-10182-D; AN/MRC-13A is installed in Truck V-35/U; and AN/MRC-13B is installed in Truck M38A1. The AN/MRC-13B also differs from the other models, in that it operates from the 24-v dc vehicular storage battery, while the AN/MRC-13 and AN/MRC-13A both operate from 13-v dc storage batteries which are part of the radio set.

TECHNICAL CHARACTERISTICS:

Frequency Range: 225 mc to 390 mc

Number of Preset Frequencies: 10

Type Modulation: AM (A2, A3)

Type Signal: Mcs, voice

Power Output: 8 w

Power Requirements: 430 w, 13-v dc 430 w, 24-v dc

MAJOR COMPONENTS

QTY	ITEM	STOCK NUMBERS	DIMENSIONS (Inches)	WEIGHT (Lbs)
1	Truck M38A1 (-13B), V-35/U (-13A),			
	or			
	Reconnaissance Car 10182-D (-13) containing:			
1	Transmitter-Receiver 43067	-----	9-1/2 x 21-1/4 x 16-1/4	45
1	Modulator-Dynamotor Unit 50248	-----	9-1/2 x 21-1/4 x 16-1/4	45
1	Installation kit			

MIL-HDBK-161

AN/MRC-13() RADIO SET

REFERENCE DATA AND LITERATURE:

SHIPPING DATA

PKGS	VOLUME (Cu Ft)	WEIGHT (Lbs)
------	----------------	--------------

PROCUREMENT DATA

PROCURING SERVICE: USN
SPEC &/or DWG:

DESIGN COG: USN

CONTRACTOR	LOCATION	CONTRACT OR ORDER NO.	APPROX UNIT COST
------------	----------	-----------------------	------------------

RADIO SET AN/MRC-16

26 November 1958

Cognizant Serv: USN FSN: 5895-665-1336

	USA	USN	USAF
TYPE CLASS:	--	Used by	--
STOCK NO:	--	--	--

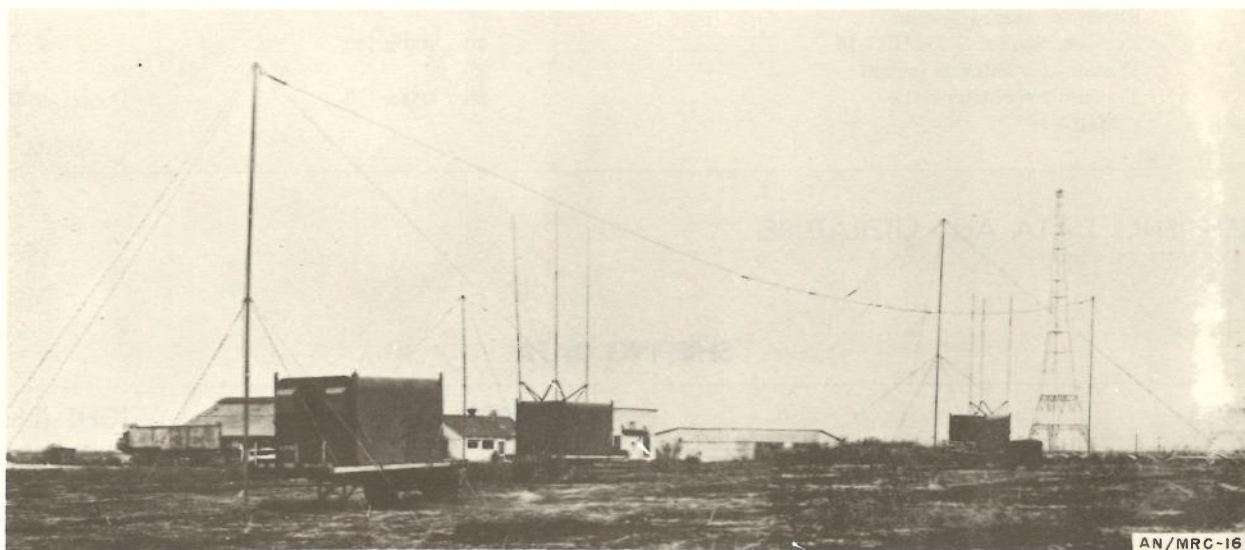

FUNCTIONAL DESCRIPTION:

Radio Set AN/MRC-16 is a mobile receiving and transmitting equipment used as a ground radio command center. It provides communication between aircraft in flight or with other ground radio stations. Application is in general air warning, fighter air defense, and in general air-to-ground and short-range ground-to-ground communication. A frequency modulated radio set is included for communication with tactical ground elements.

This equipment consists of a receiver shelter, a transmitter shelter, a power shelter, 2 power trailers and 10 remote control stations. The transmitter shelter contains the following Radio Transmitting Equipments: two TCK's, one TBM, two TCS's, and three TDQ's. The receiver shelter contains five Radio Receiving Equipments RAO and RCK and one Radio Set SCR-608. Power Unit PE-85-M, located in the power shelter, supplies power to the transmitting shelter. A motor generator, also in the power shelter, supplies power to Radio Transmitting Equipment TBM, which alone draws 5,000 watt. The receiver shelter is powered by one of the trailer-drawn Power Units PE-95, and the other serves as an auxiliary power supply for the transmitter shelter.

The remote control stations, which are not designed to be operated more than 1/2 mile distant from the main station equipment, consist essentially of a telephone set and a hand telegraph key, which are connected to any of the radio transmitting or receiving components by means of an adapter.

TECHNICAL CHARACTERISTICS:

Frequency Range:

Transmitters: 2 mc to 18 mc, 115 mc to 156 mc, 1.5 mc to 12 mc

Receivers: 54 to 30 mc, 115 mc to 156 mc, 27 mc to 38.9 mc

Type Emission and Reception: Cw, mcw, voice

Type Modulation: AM, FM

Power Output:

Transmitter:

TCK: 400 w on cw, 100 w on voice

TBM: 500 w on cw, 350 w on mcw and voice

TDQ: 45 w on cw, 25 w on mcw and voice

TCS: 40 w on cw, 20 w on voice

SCR-608: 20 w

Receivers:

RAO: 0.3 w into 600 ohms

RCK: 15 mw into 600 ohms

TCS: 6 mw

SCR-608: 2 w to loudspeaker; 200 mw to headset

Antennas: Long wire, half-wave dipole, 25 ft whip

Power Requirements:

Transmitting: 13.6 kw, 220-v 50-60-cycle 3-phase ac (including TBM, which draws 5 kw)

Receiving: 5 kw, 220-v 50-60-cycle 1-phase ac

MIL-HDBK-161

AN/MRC-16 RADIO SET

MAJOR COMPONENTS

QTY	ITEM	STOCK NUMBERS	DIMENSIONS (Inches)	WEIGHT (Lbs)
2	Power Unit PE-95	-----	75 x 74 x 95	4,200
1	Power Shelter S-2/MRC-16	-----	98 x 100 x 173	9,950
1	Receiver antenna system	-----		
1	Receiver Shelter S-3/MRC-16	-----	89 x 100 x 173	8,150
1	Transmitter antenna system	-----		
1	Transmitter Shelter S-1/ MRC-16	-----	98 x 100 x 173	9,700

REFERENCE DATA AND LITERATURE:

NAVSHIPS 91607

SHIPPING DATA

PKGS	VOLUME (Cu Ft)	WEIGHT (Lbs)
	3,550	36,200

PROCUREMENT DATA

PROCURING SERVICE: USN
SPEC &/or DWG:

DESIGN COG: USN, BuShips

CONTRACTOR	LOCATION	CONTRACT OR ORDER NO.	APPROX UNIT COST
------------	----------	--------------------------	---------------------

RADIO SET AN/MRC-18

24 November 1958

Cognizant Serv: USN FSN:

	USA	USN	USAF
TYPE CLASS:	--	Used by	--
STOCK NO:	--	--	--

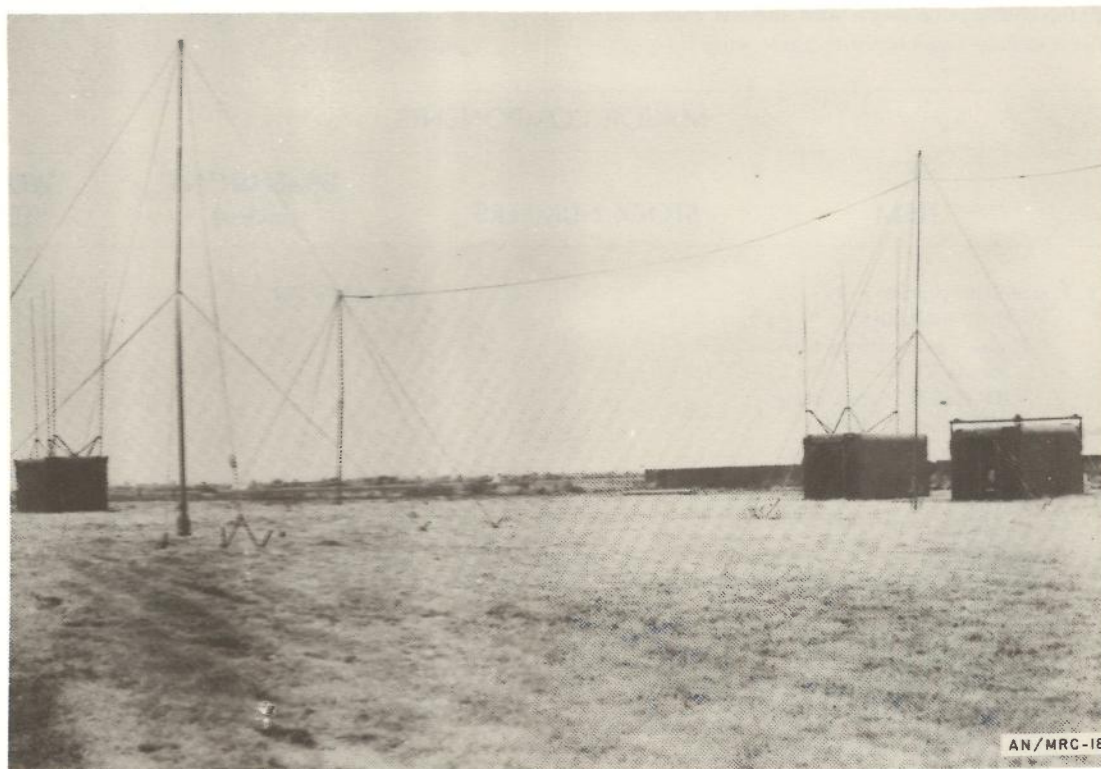

AN/MRC-18

FUNCTIONAL DESCRIPTION:

Radio Set AN/MRC-18 is a mobile medium-frequency, high-frequency, and very-high frequency equipment operating as a ground command center in two-way communication with aircraft, or with other ground installations. Provision is made for general air warning and fighter air defense operation, general air-to-ground communications, and short range communications.

This equipment consists essentially of a receiver shelter, a transmitter shelter, a power shelter, 3 power trailers, and 10 remote control stations. The transmitter shelter contains two Radio Transmitting Equipments TCK, two Radio Transmitting and Receiving Equipments TCS, and two VHF Radio Transmitting Equipments TDQ. The receiver shelter contains two Radio Receiving Equipments RAO and RCK and one Radio Set SCR-608. The power shelter contains Power Unit PE-85M for supplying the transmitter shelter. The three power trailers are one-ton two-wheel cargo trailers, each

containing one Power Unit PE-95 for supplying the receiver trailer and as auxiliary supply for the transmitter shelter.

A remote station consists of a telephone set and a hand telegraph key connected to any of the transmitters or receivers. No remote station can be operated more than 1/2 mile from the equipment.

TECHNICAL CHARACTERISTICS:*Frequency Range in Mc:*

Transmitting: 1.5 to 18, 27 to 38.9, 115 to 156

Receiving: 0.54 to 30, 27 to 38.9, 115 to 156

Type Modulation: AM or FM

Type Signal: A1, A2, A3 (cw, mcw, voice)

Transmitter Power Output:

TCK: 400 w on A1; 100 w on A3

TDQ: 45 w on A1; 25 w on A2 or A3

TCS: 40 w on A1; 20 w on A3

SCR-608: 20 w

AN/MRC-18 RADIO SET*Receiver Output:*

RAO: 0.3 w into 600 ohms

RCK: 15 mw into 600 ohms

TCS: 6 mw

SCR-608: 2 w to loudspeaker; 200 mw to headset

Antenna Receiving System: Five field arrangements of turnstile atop mast with guide wires; four whip antennas installed atop shelter; one single wire antenna connected to shelter and to mast assembly with guide wires

Antenna Transmitting System: Three field arrangements of dipole atop mast with guide wires; one single wire antenna interconnecting the three guide wire setups; and four whip antennas atop shelter

Power Requirements:

PE-85M: 10 kw, 220-v 60-cycle 3-phase ac (for transmitter shelter)

PE-95: 5-kw, 220-v 60-cycle 1-phase ac (for receiver shelter)

MAJOR COMPONENTS

QTY	ITEM	STOCK NUMBERS	DIMENSIONS (Inches)	WEIGHT (Lbs)
1	Transmitter Shelter S-1/ MRC-18 including:	-----	98 x 100 x 173	9,700
3	Radio Transmitting Equip- ments TCK			
2	VHF Radio Transmitting Equipments TDQ			
2	Radio Transmitting and Receiving Equipments TCS			
1	Receiver Shelter S-2/MRC-18 including:	-----	98 x 100 x 173	8,150
5	Radio Receiving Equip- ments RAO			
5	Radio Receiving Equip- ments RCK			
1	Radio Set SCR-608			
1	Power Shelter S-2/MRC-16	-----	98 x 100 x 173	9,950
3	Power trailers containing Power Unit PE-95	-----	75 x 74 x 95	4,200

REFERENCE DATA AND LITERATURE:

NAVSHIPS 91487

SHIPPING DATA

PKGS	VOLUME (Cu Ft)	WEIGHT (Lbs)
6	3,245	32,000

RADIO SET **AN/MRC-18**

PROCUREMENT DATA

PROCURING SERVICE: USN
SPEC &/or DWG:

DESIGN COG: USN, BuShips

CONTRACTOR	LOCATION	CONTRACT OR ORDER NO.	APPROX UNIT COST
Mare Island Naval Shipyard	Vallejo, Calif.	58703/49, 18 March 1949	

24 November 1958

Cognizant Serv: USAF FSN: 5820-505-1942

	USA	USN	USAF
TYPE CLASS:	L/Std	--	--
STOCK NO:	2S3007-20	--	--

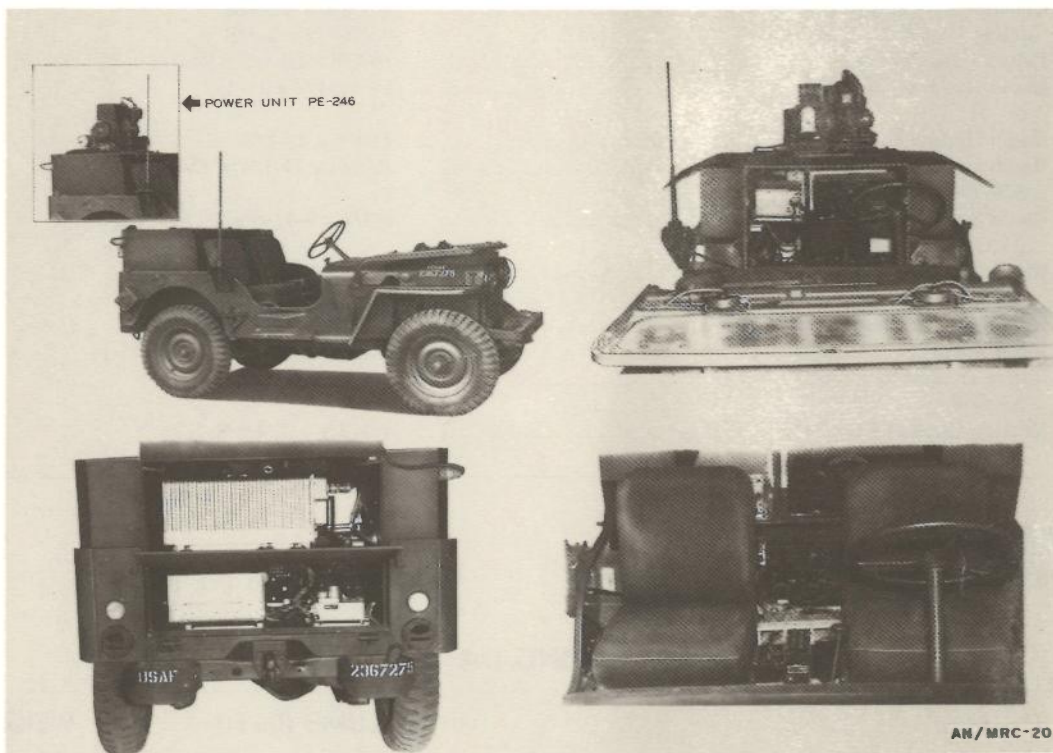
**FUNCTIONAL DESCRIPTION:**

Radio Set AN/MRC-20 is an assembly of high-frequency, very-high-frequency, and ultra-high-frequency transmitting and receiving equipment arranged for vehicular installation and operation.

This equipment is designed to provide a mobile communication system capable of operating on three different ranges, either separately, simultaneously, or automatically by voice control. As designed and used, this equipment increases the flexibility of ground and/or ground-to-air communications and enlarges the range of fixed stations.

Power is supplied by Power Unit PE-246; power required is 1,700 watts of 28.5-volt dc. For emergency use, a 28-volt, 35-ampere-hour storage battery will operate the equipment for approximately 30 minutes under normal conditions.

TECHNICAL CHARACTERISTICS:*Frequency Range in Mc:*

Transmission: 0.2 to 1.5, 2 to 18.1, 100 to 156, 225 to 399.9
 Reception: 0.2 to 0.5, 2 to 18, 100 to 156, 225 to 399.9

Number of Preset Channels:

Auto-tuned: 11; 200- to 500-kc, and 2-mc to 18-mc range
 Crystal-controlled: 8; 100-mc to 156-mc range
 Crystal-controlled: 18; 225-mc to 399.9-mc range

Total Number of Available Channels: 1,750, spaced 100 kc apart

Type Modulation: AM

Type Emission: A3 (voice, tone; cw may be used in hf and lf ranges)

Power Output:

Transmitters: 10 w (nominal)
 Receivers: 0.5 w to 3 w (nominal)

Power Requirements:

Power Unit: 1.7 kw at 28-v dc (60 amp)
 Battery: 28.5 v dc (35 amp-hour) will operate set for 1/2 hour in emergency

MIL-HDBK-161

AN/MRC-20 RADIO SET

MAJOR COMPONENTS

QTY	ITEM	STOCK NUMBERS	DIMENSIONS (Inches)	WEIGHT (Lbs)
3	Antenna groups (hf, vhf, uhf)	-----	30 x 19 (approximately)	25.0
1	Control Box C-118/ARC-3	-----	2-5/8 x 6 x 6-7/8	2.1
1	Control Unit C-87/ART-13	-----	8 x 3-1/2 x 3-3/8	2.1
1	Power Unit PE-246	-----	16-7/8 x 20-1/2 x 24-3/8	113.0
1	Radio Receiver BC-348-Q, or -R	-----	18 x 9-1/2 x 10-1/2	41.0
1	Radio Receiver R-77/ARC-3	-----	11 x 6 x 15-1/2	17.0
1	Radio Receiver-Transmitter RT-178/ARC-27	-----	12-3/8 x 11-1/4 x 27-7/8	71.0
1	Radio Set Control C-626/ ARC-27	-----	6-3/8 x 9-9/16 x 5-1/4	11.2
1	Radio Set Control C-628/ ARC-27	-----	3-1/4 x 8-1/2 x 3	1.3
1	Radio Transmitter T-47A/ ART-13	-----	23-1/2 x 11-1/2 x 14-1/2	103.6
1	Radio Transmitter T-67/ ARC-3	-----	12-1/4 x 7-1/2 x 15	17.5
2	Remote Control RC-261	-----	4-1/4 x 4-1/4 x 8-1/2	21.0

REFERENCE DATA AND LITERATURE:

TO 31R2-2MRC20-14

SHIPPING DATA

PKGS	VOLUME (Cu Ft)	WEIGHT (Lbs)
------	----------------	--------------

PROCUREMENT DATA

PROCURING SERVICE: USAF
SPEC &/or DWG:

DESIGN COG: USAF, RCUE

CONTRACTOR	LOCATION	CONTRACT OR ORDER NO.	APPROX UNIT COST
------------	----------	--------------------------	---------------------

Northeastern Engineering, Inc.

Manchester, N. H.

24 November 1958

Cognizant Serv: USN FSN: 5820-665-3871

USA

USN

USAF

TYPE CLASS: --

Used by --

STOCK NO: --

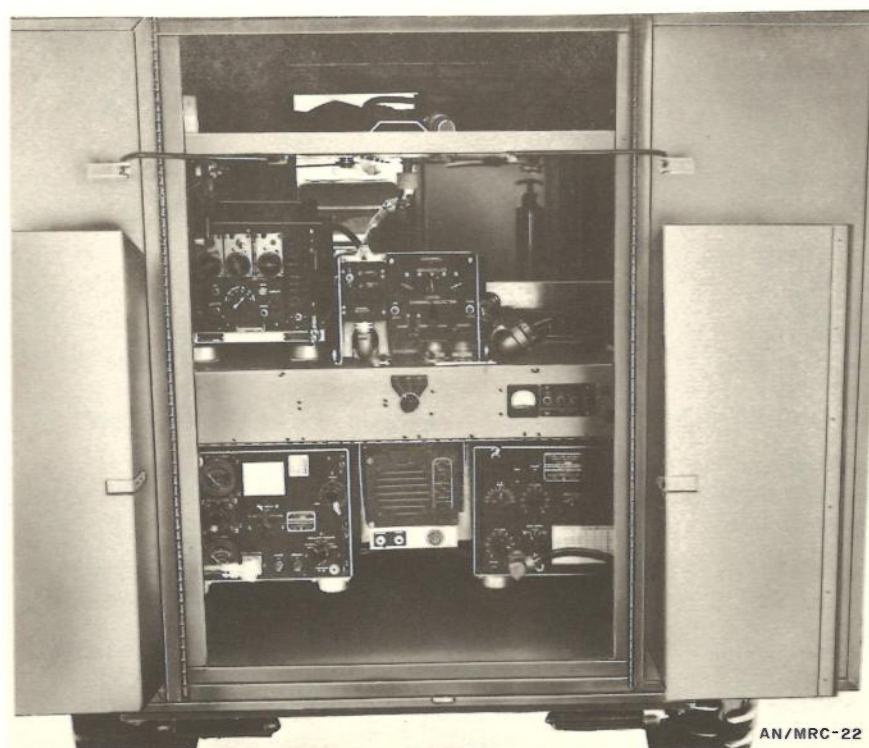

AN/MRC-22

FUNCTIONAL DESCRIPTION:

Radio Set AN/MRC-22 is a mobile multichannel high-frequency, very-high-frequency, and ultra-high-frequency two-way communication equipment. It is primarily designed to be used as a command station for ground-to-aircraft and point-to-point communication.

This equipment consists essentially of three transceivers, a motor generator assembly, and a gasoline-driven motor generator installed in a two-wheel trailer. The equipment ensemble makes up a complete, self-powered, radio communication station that can be quickly moved to any ground location.

TECHNICAL CHARACTERISTICS:

Frequency Range in Mc:

TCS: 1.5 to 12

AN/ARC-1: 100 to 156

AN/ARC-27: 225 to 400

Type Modulation: AM

Type Signal: Cw, mcw, voice

Number of Preset Channels:

1.5-mc to 12-mc Range: 10

100-mc to 156-mc Range: 18

Frequency Control: Crystal

Total Number of Channels: 1.751

Remote Channel: Up to 25 ft

Power Output:

Cw: 25 w

Mcw, Voice: 10 w

Power Requirements: Incorporates its own gasoline engine generator and motor-generator assembly

MIL-HDBK-161

AN/MRC-22 RADIO SET

MAJOR COMPONENTS

QTY	ITEM	STOCK NUMBERS	DIMENSIONS (Inches)	WEIGHT (Lbs)
1	Antenna AS-390/SRC			
1	Antenna NT-66150A			
2	Chest Set Group AN/GSA-6			
1	Control panel			
1	Control Unit C-45/ARC-1	-----	2-5/8 x 3-3/8 x 6-1/8	1.00
1	Dynamotor Power Unit NT-211330-B	-----	8-25/32 x 9-5/8 x 12-15/16	35.00
2	Headset-Microphone H-63/U			
	Interconnecting cables			
1	Leg Band, Telegraph Key NT-10531			
1	Mast Base AB-15/GR			
3	Mast Section MS-116			
1	Mast Section MS-117			
1	Mast Section MS-118			
1	Mounting (modified) MT-230/ARC	-----	5 x 10-15/16 x 24-3/16	4.25
1	Mounting (modified) MT-822/ARC-27	-----	2-1/2 x 11-11/16 x 19-3/4	3.50
1	Power Unit PU-250/U	-----	18-1/4 x 21-1/4 x 27	126.00
1	Radio Receiver NT-46159-A	-----	11-1/16 x 11-7/8 x 13-13/16	38.13
1	Radio Set Control C-626/ARC-27	-----	5-1/2 x 6-3/8 x 9-9/16	9.75
1	Radio set control	-----	2-15/16 x 6-15/16 x 7	3.25
1	Radio Transmitter NT-52245-A	-----	11 x 11-13/16 x 13-3/4	48.00
1	Radio Transmitter-Receiver RT-18/ARC-1	-----	9-1/32 x 10-19/32 x 24-3/16	47.00
1	Receiver-Transmitter RT-178/ARC-27	-----	11-1/4 x 12-3/8 x 27-7/8	72.20
1	Telegraph Key 26026			
2	Telephone EE-8	-----	3-1/2 x 7-11/16 x 9-9/16	19.50
1	Trailer body	-----	47 x 58-1/4 x 76-1/4	250.00
1	Trailer Chassis M-115	-----	30-1/2 x 38-1/4 x 106	280.00

REFERENCE DATA AND LITERATURE:

NAVSHIPS 91876

SHIPPING DATA

PKGS	VOLUME (Cu Ft)	WEIGHT (Lbs)
	295	1,630

RADIO SET **AN/MRC-22**

PROCUREMENT DATA

PROCURING SERVICE: USN
SPEC &/or DWG: MIL-R-16037B(Ships)

DESIGN COG: USN, BuShips

CONTRACTOR	LOCATION	CONTRACT OR ORDER NO.	APPROX UNIT COST
Waterproof Electric Co.	Burbank, Calif.	NObsr-52518, 8 June 1951	\$8,300.00

RADIO SET **AN/MRC-23**

24 November 1958

Cognizant Serv: USN FSN: 5895-665-1337

USA

USN

USAF

TYPE CLASS: --
STOCK NO: --

Used by --

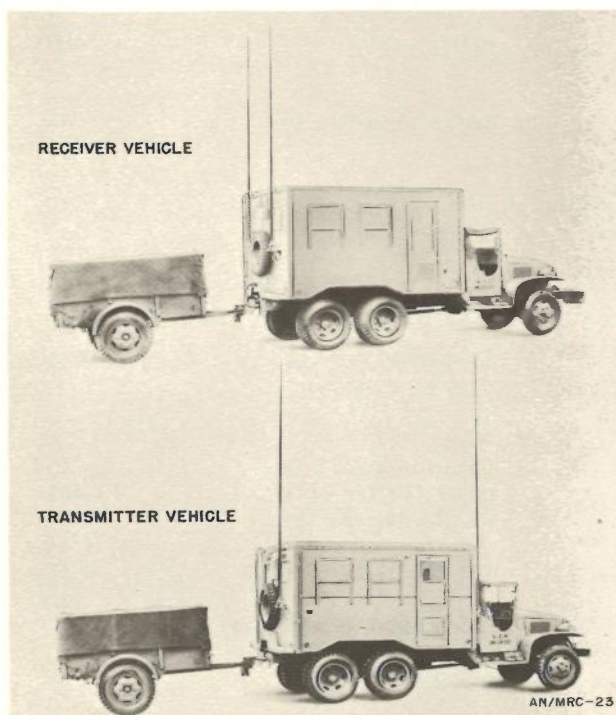

Antennas, cables, ground rack; and mast and guy assemblies are stored in the truck during transit.

TECHNICAL CHARACTERISTICS:*Frequency Range in Mc:* 1.5 to 400, not continuously*Transmitter TDE-1:*

Frequency Range in Mc: 1.5 to 18

Type Emission: A1, A2, A3

Power Output: A1, 125 w; A2, 35 w; A3, 30 w

Transmitter AN/URT-7:

Frequency Range in Mc: 115 to 156; four crystal-controlled preset channels

Type Emission: A2, A3

Power Output: 45 w

Transmitter TED-1:

Frequency Range in Mc: 225 to 400; four preset crystal-controlled channels

Type Emission: A2

Transmitter-Receiver TCS-1:

Frequency Range in Mc: 1.5 to 12; continuous coverage in 3 bands

Type Emission: A1, A3

Power Output: A1, 40 w; A3, 20 w

Audio Power Output: 1.5 w

Receiver RCH:

Frequency Range: 80 kc to 560 kc; 1.9 mc to 24 mc in 5 bands

Audio Power Output: 2 w

Receiver AN/FRR-27:

Frequency Range in Mc: 115 to 156

Audio Power Output: 1.5 w

Receiver AN/URR-13A:

Frequency Range in Mc: 225 to 400

Audio Power Output: 0.06 w

Power Requirements:

PE-95-G: 12.5 w (output), 115-v 60-cycle 1-phase ac

FUNCTIONAL DESCRIPTION:

Radio Set AN/MRC-23 is a self-contained mobile radio communications center suitable for operations in ground-to-air tactical radio nets.

This equipment includes a transmitter truck and receiver truck. Each truck obtains its primary power from an associated trailer-mounted gasoline engine generator. The receiver truck has two antenna masts; the transmitter truck one.

MAJOR COMPONENTS

QTY	ITEM	STOCK NUMBERS	DIMENSIONS (Inches)	WEIGHT (Lbs)
<i>With Receiver Truck 6 x 6, K-53:</i>				
2	AF Amplifier AM-215A/U	-----	7 x 8-3/8 x 12	23.5
3	Antenna Assembly AT-150/ SCR	-----	4-3/4 ft	4.5

AN/MRC-23 RADIO SET

MAJOR COMPONENTS—Continued

QTY	ITEM	STOCK NUMBERS	DIMENSIONS (Inches)	WEIGHT (Lbs)
3	Antenna Assembly NT-66095	-----	4 ft	17
2	Antenna Duplexer CU-359/ MRC-23	-----	2-1/16 x 4-5/16 x 6-1/8	2.5
2	Antenna Mast AB-334/G	-----	49 ft	100
3	Chair	-----		
1	Clock, 24-hour	-----		
1	Control Panel SB-293/MRC-23	-----	7-5/8 x 15-23/32 x 19	36
3	Desk lamp	-----		
1	Exhaust fan	-----		
1	Ground cable	-----	5 ft	
1	Ground stake	-----	5 ft	4
3	Headset-Microphone H-63/U	-----		
1	Heater Type P	-----		15
2	HF Whip Antenna AT-441/ MRC-23	-----	35 ft	19
1	Jack Box J-545/MRC-23	-----	2-3/4 x 4-1/2 x 9-1/4	5.5
2	Loudspeaker CUL-49546	-----	7-3/4 x 8 x 10-15/16	
2	Operator desk	-----		
1	Power distribution box	-----	4-7/8 x 7 x 31	
1	Power Supply PP-952/MRC-23	-----	7-5/8 x 15-23/32 x 19	19
1	Power Unit PE-95-G	-----	28-1/4 x 38-1/2 x 67-1/2	1,556
3	Radio Receiving Set AN/ FRR-27	-----	5-7/32 x 14-1/2 x 19	
3	Radio Receiving Set AN/ URR-13	-----	6-31/32 x 17-1/2 x 19-1/3	57
2	Radio Receiving Set Model RCH	-----	12-1/8 x 20-7/16 x 20-13/16	106
2	Radio Set Control C-1235/ MRC	-----	3 x 4 x 4	2
6	Rf cable assembly	-----	100 ft	
1	Supervisor's desk	-----		
2	Telegraph key	-----		
1	Telephone EE-8-()	-----		11.5
2	Typewriter	-----		
<i>With Transmitter Truck 6 x 6, K-53:</i>				
2	Antenna Assembly AS-390/ SRC	-----	16	3.625
2	Antenna Assembly NT-66095	-----	4 ft	
1	Antenna Mast AB-334/G	-----	49 ft	100
1	Chair	-----		
1	Clock	-----		
1	Control Panel SB-294/MRC-23	-----	7-1/4 x 10-1/8 x 14-1/2	15
1	Control position desk	-----		
1	Crystal Calibrated Frequency Indicating Equipment LM-18	-----		25.5
1	Desk lamp	-----		
1	Emergency electronic repair kit	-----		
1	Exhaust fan	-----		
1	Field Telephone EE-8-()	-----		11.5
1	Ground cable	-----	5 ft	

RADIO SET **AN/MRC-23**

MAJOR COMPONENTS—Continued

QTY	ITEM	STOCK NUMBERS	DIMENSIONS (Inches)	WEIGHT (Lbs)
1	Ground rod	-----	5 ft	4
1	Heater Type P	-----	-----	15
2	HF Whip Antenna AT-441/ MRC-23	-----	35 ft	
2	Jack Box J-546/MRC-23	-----	1-15/16 x 4-1/4 x 5-3/4	2.5
1	Multimeter TS-352/U	-----	-----	15
1	Power distribution box	-----	4-7/8 x 7 x 31	
1	Power Supply PP-338/U	-----	10 x 12-1/2 x 26	120
1	Power Unit PE-95-G	-----	28-1/4 x 38-1/2 x 67-1/2	1,556
2	Radio Transmitting Equipment AN/URT-7	-----	13-23/32 x 16-1/2 x 19	146
1	Radio Transmitting Equipment TDE-()	-----	20-1/2 x 28-1/4	334
2	Radio Transmitting Equipment (TED-()	-----	13-23/32 x 15 x 19	146
1	Radio Transmitting and Re- ceiving Equipment TCS-()	-----	-----	180
1	Rectifier Power Supply Unit Unit Type-CBEQ20219-A	-----	10-1/8 x 11-11/16 x 17-1/4	94
4	RF cable assembly	-----	100 ft	
1	RF Signal Generator Set AN/ URM-25B	-----	10-1/4 x 10-1/4 x 13	35
1	RF Wattmeter AN/URM-43	-----	4-3/4 x 6-1/2 x 9-1/2	15
3	Reel and Wire Reel DR-4 Wire WD-1/TT	-----	-----	87
1	Terminal Box J-544/MRC-23	-----	-----	2.5

REFERENCE DATA AND LITERATURE:

NAVSHIPS 91962

SHIPPING DATA

PKGS	VOLUME (Cu Ft)	WEIGHT (Lbs)
2 Power Unit PE-95-G	----	1,650
1 Receiver truck	----	14,500
1 Transmitter Truck	----	15,000

MIL-HDBK-161

AN/MRC-23 RADIO SET

PROCUREMENT DATA

PROCURING SERVICE: USN
SPEC &/or DWG:

DESIGN COG: USN, BuShips

CONTRACTOR	LOCATION	CONTRACT OR ORDER NO.	APPROX UNIT COST
Adlers Communications Laboratories	New Rochelle, N. Y.	NObsr-52703, 26 June 1951	\$48,400.00

RADIO SET **AN/MRC-24**

24 November 1958

Cognizant Serv: USN FSN:

USA

USN

USAF

TYPE CLASS:	--	Used by	--
STOCK NO:	--	--	--

(No Illustration Available)

FUNCTIONAL DESCRIPTION:

Radio Set AN/MRC-24 is a mobile communication equipment providing point-to-point high-frequency and line-of-sight very-high-frequency communication. Point-to-point communication is possible when the vehicle is moving.

Auxiliary equipment, such as mobile power supply, test equipment, antenna materials, maintenance parts and tools, are included with each radio set. The major components are permanently installed in a 2-1/2 ton, 6 x 6 truck provided with a built-in heater and exhaust ventilation fan.

TECHNICAL CHARACTERISTICS:*Transmitter TCK-4:*

Frequency Range: 2,000 kc to 18,100 kc

Type Emission: Cw or AM

Power Output: 400 w on cw; 100 w on AM

Transmitter-Receiver TCS-12:

Frequency Range: 1,500 kc to 12,000 kc

Type Emission: Cw or AM

Power Output: 40 w on cw; 20 w on AM

Tuning: Manual; 4 crystal channels available

Transmitter TDQ:

Frequency Range in Mc: 115 to 156

Type Emission: Mcw or voice

Power Output: 45 w nominal

Control: Crystal control on 4 channels

Receiver RCK:

Frequency Range in Mc: 115 to 156

Control: Crystal control on 4 channels

Transmitter-Receiver MAR:

Frequency Range in Mc: 225 to 390

Type Emission: Mcw or voice

Power Output: 8 w nominal

Control: Crystal control on 10 channels

Receiver RCH:

Frequency Range: 80 kc to 560 kc and 1.9 mc to 24 mc

Type Reception: Radiotelephone or telegraph signals

Number of Bands: 5

Power Requirements: 7-1/2 kw 115-v 60 cycle 1-phase ac

MAJOR COMPONENTS

QTY	ITEM	STOCK NUMBERS	DIMENSIONS (Inches)	WEIGHT (Lbs)
1 set	Accessories			
1	Adapter Kit NT-49992			
1	Antenna NT-66095			
1	Antenna NT-66147			
1 set	Antenna accessories			
1	Frequency Meter MI-15			
4	Mast Section NT-66103			
4	Mast Section NT-66104			
4	Mast Section NT-66105			
4	Mast Section NT-66106			
4	Mast Section NT-66107			
1	Mobile Engine Generator EAT			
1	Multimeter ME-25/U			
1	Multimeter TS-352/U			
3	Receiver RCH			
1	Receiver RCK			
1	RF Signal Generator AN/ URM-25			
1	Tool Set TE-113			

MIL-HDBK-161

AN/MRC-24 RADIO SET

MAJOR COMPONENTS—Continued

QTY	ITEM	STOCK NUMBERS	DIMENSIONS (Inches)	WEIGHT (Lbs)
1	Transmitter TCK-4			
1	Transmitter TDQ			
1	Transmitter-Receiver MAR			
1	Transmitter-Receiver TCS-02 with remote adapter			
1	Truck 2-1/2 ton, 6 x 6 (GMC)			
1	Tube Tester TV-3/U			
1 set	Vehicle accessories			

REFERENCE DATA AND LITERATURE:

NAVSHIPS 91603

SHIPPING DATA

PKGS	VOLUME (Cu Ft)	WEIGHT (Lbs)
------	----------------	--------------

PROCUREMENT DATA

PROCURING SERVICE: USN
SPEC &/or DWG:

DESIGN COG: USN, BuShips

CONTRACTOR	LOCATION	CONTRACT OR ORDER NO.	APPROX UNIT COST
------------	----------	--------------------------	---------------------

RADIO CENTRAL AN/MRC-25

24 November 1958

Cognizant Serv: USN FSN:

	USA	USN	USAF
TYPE CLASS:	--	Used by	--
STOCK NO:	--	--	--

(No Illustration Available)

FUNCTIONAL DESCRIPTION:

Radio Central AN/MRC-25 is a truck operating as part of Communication Central AN/MSC-3. It is principally designed to provide spare part storage space and facilities for maintenance of Communication Central AN/MSC-3.

This equipment also provides radio transmitting and receiving sets intended to operate in conjunction with associated communication vehicles.

TECHNICAL CHARACTERISTICS:

Frequency Range in Mc:

RCK: 115 to 156

RDZ: 200 to 400

TDO: 115 to 156

TDZ: 225 to 4,000

Type Emission and Reception: A2, A3*Power Requirements:* 115-v 60-cycle ac

MAJOR COMPONENTS

QTY	ITEM	STOCK NUMBERS	DIMENSIONS (Inches)	WEIGHT (Lbs)
1	Truck K-56 includes:	-----	93 x 121-1/2 x 259	
2	Antenna NT-66095			
2	Antenna NT-66147			
4	Case CY-29/TRC			
2	Coaxial Cable RG-10/U			
2	Coaxial Cable RG-18/U			
1	Field Telephone EE-8			
1	Gas Engine Generator NT-73029			
1	Ground rod			
1	Interconnecting Cable NT-TTRS-16			
1	Mast for AN/TRC-1			
1	Multimeter ME-25/U			
2	Oscilloscope OLB-1			
1	Power Cable NT-TCOP-9			
1	Power Distribution Panel 24-S			
1	Radio Receiving Equip- ment RCK			
1	Radio Receiving Equip- ment RDZ			
2	Radio Teletype Terminal AN/SGC-1			
1	Radio Transmitting Equipment TDQ			
1	Radio Transmitting Equip- ment TDZ			
1	Receiver Analyzer OE-12			
1	Signal Generator LAJ-2			

AN/MRC-25 RADIO CENTRAL**MAJOR COMPONENTS—Continued**

QTY	ITEM	STOCK NUMBERS	DIMENSIONS (Inches)	WEIGHT (Lbs)
1	Signal Generator LF series			
32	Spare parts cabinet, 4 drawer, with spare parts			
16	Spare parts cabinet, 8 drawer, with spare parts			
2	Teletype Tool Kit TE-50A			
4	Tool Kit NT-10223			
1	Transformer W.E. 85U390			
1	TTY Test Equipment I-208			
1	TTY Test Set TS-659			
1	TTY Test Set TS-660			
3	Tube Tester TV-3/U			

REFERENCE DATA AND LITERATURE:

NAVSHIPS 92158

SHIPPING DATA

PKGS	VOLUME (Cu Ft)	WEIGHT (Lbs)
------	----------------	--------------

PROCUREMENT DATA

PROCURING SERVICE: USN
SPEC &/or DWG:

DESIGN COG: USN, BuShips

CONTRACTOR	LOCATION	CONTRACT OR ORDER NO.	APPROX UNIT COST
------------	----------	--------------------------	---------------------

24 November 1958

Cognizant Serv: USN FSN: 5820-642-7592

	USA	USN	USAF
TYPE CLASS:	--	Used by	--
STOCK NO:	--	--	--

(No Illustration Available)

FUNCTIONAL DESCRIPTION:

Radio Set AN/MRC-32 is a high power vehicular radio station providing facilities for transmission and reception of radioteletypewriter signals by means of frequency-shift modulation. In addition, continuous wave, telegraphy, and voice facilities are provided. Voice signals can be sent alone or together with the frequency-shift modulated radioteletype signals.

This equipment consists essentially of Radio Set AN/GRC-26A mounted on a 2-1/2-ton cargo Truck M-35 and a trailer-mounted Power Unit PU-290/MR. All components except the power unit are contained in Shelter S-69/GRC.

The radio set is capable of operating in motion or in a stationary position. The teletypewriter equipment operates most satisfactorily when stationary. It is possible to operate the teletypewriter equipment from a remote position.

TECHNICAL CHARACTERISTICS:*Frequency Range in Mc:*

Transmitter BC-610-H: 2 to 18; 3 channels
Receiver R-388/URR: 0.5 to 30.5

Operational Range:

Cw or Fs: 250 miles
Voice: 100 miles

Type Modulation: FM and AM simultaneously or separately

Type Tuning: Master oscillator or crystal

Antenna: Whip or doublet and long wire

Transmitter Power Output:

Cw or Fs Operation: 400 w
Voice Operation: 300 w

Fs and Voice Simultaneously: 300 w

Power Requirements:

Transmitter BC-610-H: 115-v 50- to 50- cycle ac
Receiver R-388/URR: 115-v or 230-v, 45- or 70-cycle ac

MAJOR COMPONENTS

QTY	ITEM	STOCK NUMBERS	DIMENSIONS (Inches)	WEIGHT (Lbs)
1	Frequency Meter Set SCR-211	2C1411.5		
1	Multimeter TS-352B/U	3F3324-9.352B		
1	Oscillator, Radio Frequency O-39C/TRA-7	5815-224-5287		
1	Perforator-Transmitter TT- 56/MGC	5815-198-9033		
1	Power Supply RA-87-A	5815-230-7257	18 x 19 x 10-1/2	
1	Radio Set AN/GRC-26A	2S2501-26A		
1	Radio Set Control Group AN/ GRA-14	5820-503-1090		
2	Receiver, Radio R-388/URR	5820-644-0990		
2	Teletypewriter TT-55/MGC	4TTT55		
1	Transmitter, Radio BC-610-H	5820-189-7042	32-5/8 x 21-3/8 x 39-7/8	

REFERENCE DATA AND LITERATURE:

TM 11-257/TO16-35039-15

TM 11-264A/TO16-30GRC26-15

TM 11-300; TM 11-333; TM 11-352

TM 11-359; TM 11-826/TO16-40BC610-6

AN/MRC-32 RADIO SET

REFERENCE DATA AND LITERATURE:—Continued

TM 11-854/TO16-35R-388-5
TM 11-904; TM 11-957A; TM 11-2201
TM 11-2222; TM 11-2223; TM 11-5054/TO16-40BC614-6
TM 11-5062/TO16-35PP712-5
TM 11-5527A

SHIPPING DATA

PKGS	VOLUME (Cu Ft)	WEIGHT (Lbs)
------	----------------	--------------

PROCUREMENT DATA

PROCURING SERVICE: USN
SPEC &/or DWG:

DESIGN COG: USN

CONTRACTOR	LOCATION	CONTRACT OR ORDER NO.	APPROX UNIT COST
------------	----------	-----------------------	------------------

RADIO SET CENTRAL AN/MRC-35A

25 November 1958

Cognizant Serv: USN FSN: 5895-543-0582

USA

USN

USAF

TYPE CLASS:
STOCK NO:

Used by

(No Illustration Available)

FUNCTIONAL DESCRIPTION:

Radio Set AN/MRC-35A is a mobile radio station for control of tactical aircraft operating in close support of ground forces. The mobile radio equipment will provide forward aircraft control by ground-to-air and ground-to-ground communications.

This equipment is capable of net operation with standard amplitude-modulated low-, medium-, and high-frequency ground radio sets and ultra-high-frequency airborne radio sets.

The unit will provide homing facilities for aircraft; communications with aircraft during convoy movement; and temporary airstrip control, and control of rescue operations. The low-frequency radio equipment cannot be used while the vehicle is in motion.

TECHNICAL CHARACTERISTICS:

Frequency Range:

Receiver BC-348-Q: 200 kc to 500 kc; 1.5 mc to 18 mc

Receiver-Transmitter RT-178/ARC-27: 225 mc to 399.9 mc

Transmitter T-47/ART-13: 200 kc to 600 kc; 2 mc to 18.1 mc

Type Emission and Reception:

Receiver BC-348-Q: Cw, AM voice

Receiver-Transmitter RT-178/ARC-27: Mew, AM voice

Transmitter T-47/ART-13: Cw, mew, AM voice

Transmitter Output:

Transmitter T-47/ART-13:

200 Kc: 5.5 w

4 Mc: 40 w

9 Mc: 90 w

18.1 Mc: 65 w

Receiver-Transmitter RT-178/ARC-27: 9 w

Antenna: Whip, long wire, coaxial stub*Power Requirements:* 28 v dc

MAJOR COMPONENTS

QTY	ITEM	STOCK NUMBERS	DIMENSIONS (Inches)	WEIGHT (Lbs)
1	Control Group AN/GRA-6	5820-537-3848		
1	Dynamotor DY-12/ART-13	6125-093-7068	10-1/4 lg	
2	Headset-Microphone Assembly AN/URA-2	5965-296-2796		
1	Radio Receiver BC-348-Q	-----	18 x 10-1/2 x 9-1/2	
1	Radio Set Control C-626/ ARC-27	2C684-626	9-9/16 x 6-3/8 x 5-1/2	
1	Radio Set Control C-2198/ MRC-35A	5820-543-0104	16-1/2 x 10-3/4 x 4-7/8	
1	Radio Transmitter T-47/ ART-13	5821-505-0011	23-9/16 x 12-3/8 x 10-3/4	
1	Receiver-Transmitter, Radio RT-178/ARC-27	5820-642-7845		
1	Truck, Utility Model M38A1			

MIL-HDBK-161

AN/MRC-35A RADIO SET CENTRAL

REFERENCE DATA AND LITERATURE:

AN 08-30ART13-5
NAVSHIPS 91338
TM 11-692B-1/AN16-30ART13-4
TM 11-692-2/AN16-30ART13-3
TM 11-692C-1/AN16-30ARC27-3
TM 11-692C-2/AN16-30ARC27-2
TM 11-692D/TO12R2-3BC-348-2
TM 11-5038/TO16-30GRA6-5

SHIPPING DATA

PKGS	VOLUME (Cu Ft)	WEIGHT (Lbs)
------	----------------	--------------

PROCUREMENT DATA

PROCURING SERVICE: USN
SPEC &/or DWG:

DESIGN COG: USN

CONTRACTOR	LOCATION	CONTRACT OR ORDER NO.	APPROX UNIT COST
------------	----------	--------------------------	---------------------

RADIO SET AN/MRC-36

25 November 1958

Cognizant Serv: USN FSN: 5820-665-1224

	USA	USN	USAF
TYPE CLASS:	--	Used by	--
STOCK NO:	--	--	--

(No Illustration Available)

FUNCTIONAL DESCRIPTION:

Radio Set AN/MRC-36 is a short-range radiotelephone communication unit primarily applicable within and between armored, artillery, and infantry units.

This equipment with associated accessories consists essentially of Radio Set AN/GRC-3 installed in Truck M38A1.

TECHNICAL CHARACTERISTICS:

AF Amplifier AM-65/GRC:

Input Impedance:

- RT-66/GRC: 1,500 ohms (interphone channel)
- RT-70/GRC or RT-70A/GRC: 1,500 ohms (interphone channel)
- RT-66/GRC and RT-70/GRC RT-70A/GRC: 150 ohms (interphone channel)

Output Impedance: 150 ohms and 600 ohms (adjustable)

Af Response: Flat to within 4 db for frequencies between 400 and 2,500 cps with sharp cutoff beyond these limits

Radio Receiver R-108/GRC:

Frequency Range Mc: 20 to 28

Type Receiver: Single conversion superheterodyne

Type Modulation: FM

Sensitivity: Over 25-db signal plus noise-to-noise ratio at $1/2 \mu\text{v}$, deviation $\pm 15 \text{ kc}$, 1,000 cps

Type of Tuning: Continuously variable and detent selection of three preset frequencies

Channel Spacing: 100 kc

Audio Output:

Loudspeaker: 500 mw

Earphones: 40 mw

Fixed level: 20 mw $\pm 3 \text{ mw}$

Audio Output Impedance: 600 ohms unbalanced

Receiver-Transmitter RT-66/GRC:

Frequency Range in Mc: 20 to 27.9

Type Transmission and Reception: Voice and 1,600 cps ringing tone

Type Modulation: FM

Operational Range: Approximately 10 miles (vehicle in motion); 15 miles, stationary

Type Tuning: Choice of detent or preset channels or continuous tuning

Detent Channels Available: 80

Preset Detent Channels: 2

Channel Spacing: 100 kc

Type Receiver: Double conversion superheterodyne

Power Output, Transmitter:

Low Power: 2 w

High Power: 16 w

Audio Input Impedance: 150 ohms

Power Output, Receiver:

Loudspeaker: 800 mw

Handset: 50 mw

Fixed Level: 20 mw

Receiver-Transmitter RT-70/GRC or RT-70A/GRC:

Frequency Range in Mc: 47 to 58.4

Type Transmission and Reception: Voice

Type Modulation: FM

Operational Range: Approximately 1 mile

Type Tuning: Continuous

Preset Detent Channels: 2

Channel Spacing: 100 kc

Transmitter Power Output: 500 mw

Transmitter Audio Input Impedance: 150 ohms at 1,000 cps

Type Receiver: Double conversion superheterodyne

Receiver Audio Output Power: 75 mw for $\pm 15 \text{ kc}$ deviation at 1,000 cps

Receiver Audio Output Impedance: 600 ohms

Power Requirements:

Power Supply PP-282/GRC:

Input Power: 20 to 32 v dc at 1.23 amp max

Output Power: 135 v dc at 0.118 amp

Power Supply PP-112/GR: 25.2 v dc at 7.0 amp (input power)

MAJOR COMPONENTS

QTY	ITEM	STOCK NUMBERS	DIMENSIONS (Inches)	WEIGHT (Lbs)
1	Adapter UG-273/U	5935-149-3534	1-7/32 lg	
1	Adapter UG-306/U	5935-171-3016	1 x 7/8 x 1/2	
1	Cabinet CY-731B/MRC	6F300-731B	42-7/8 x 18-11/16 x 17-1/8	

AN/MRC-36 RADIO SET

MAJOR COMPONENTS—Continued

QTY	ITEM	STOCK NUMBERS	DIMENSIONS (Inches)	WEIGHT (Lbs)
1	Cabinet CY-732/MRC	2Z1891-732	30 x 16-1/2 x 9-7/8	
1	Cable Assembly CG-568/U	5995-255-1334	51-15/16 lg	
1	Case, Standardized Components, Electrical CY-1460/MRC	6F207-78	15 x 12 x 13	
1	Chest Set AN/GSA-6	5965-355-7649		
1	Dynamic Loudspeaker LS-166/U	5965-243-6420	5-31/32 x 3-3/16 x 7-1/32	
3	Headset-Microphone H-63E/U	5965-237-8049		
1	Mast Base MP-65-B	5820-503-2953	18 lg x 3-1/8 dia	
1	Mast Section MS-116 or MS-116A	5985-199-8831	39-1/2 lg x 0.393 dia	
1	Mast Section MS-117 or MS-117A	5985-199-8843	39-1/2 lg x 0.373 dia	
1	Mast Section MS-118 or MS-118A	5985-199-8841	39-1/2 lg x 0.246 dia	
1	Radio Set AN/GRC-3	2S12-3/24		
1	Truck, utility, 1/4 ton	2320-204-3323		

REFERENCE DATA AND LITERATURE:

TM 11-284/TO16-30GRC-36
 TM 11-289/TO16-35RT66-5
 TM 11-290; TM 11-898
 TM 11-5036/TO31R2-2GRC3-31
 TM 11-5038/TO16-30GRA6-5
 TM 11-5039; TM 11-5040

SHIPPING DATA

PKGS	DIMENSIONS (Inches)	VOLUME (Cu Ft)	WEIGHT (Lbs)
------	---------------------	----------------	--------------

PROCUREMENT DATA

PROCURING SERVICE: USN
 SEPC &/or DWG:

DESIGN COG: USN

CONTRACTOR	LOCATION	CONTRACT OR ORDER NO.	APPROX UNIT COST
------------	----------	-----------------------	------------------

25 November 1958

Cognizant Serv: USN FSN: 5820-644-0930

USA

USN

USAF

TYPE CLASS: --

Used by --

STOCK NO: --

(No Illustration Available)

FUNCTIONAL DESCRIPTION:

Radio Set AN/MRC-37 is primarily designed for short-range operation within and between armored, artillery, and infantry units.

This equipment with associated accessories consists essentially of Radio Set AN/GRC-5 installed in a Truck M38A1.

TECHNICAL CHARACTERISTICS:**AF Amplifier AM-65/GRC:**

Input Impedance:

RT-67/GRC: 1,500 ohms (interphone channel)

RT-70/GRC or RT-70A/GRC: 1,500 ohms (interphone channel)

RT-67/GRC and RT-70/GRC or RT-70A/GRC: 150 ohms (interphone channel)

Output Impedance: 150 ohms and 600 ohms (adjustable)

AF Response: Flat to within 4 db for frequencies between 400 and 2,500 cps with sharp cutoff beyond these limits

Radio Receiver R-109/GRC:

Frequency Range in Mc: 27 to 39

Type Receiver: Single conversion superheterodyne

Type Modulation: FM

Sensitivity: Over 25 db signal plus noise-to-noise ratio at 1/2 μ v, deviation ± 15 kc, 1,000 cps

Type of Tuning: Continuously variable and detent selection of 3 preset frequencies

Channel Spacing: 100 kc

Audio Output:

Loudspeaker: 500 mw

Earphones: 40 mw

Fixed level: 20 mw

Audio Output Impedance: 600 ohms unbalanced

Receiver-Transmitter RT-67/GRC:

Frequency Range in Mc: 27 to 38.9 and 47 to 58.4

Type Transmission and Reception: Voice and 1,600 cps ringing tone

Type Modulation: FM

Operational Range:

Vehicle in Motion: 10 miles

Stationary: 15 miles

Type Tuning: Detent or preset channels or continuous tuning

Detent Channels: 120

Channel Spacing: 100 kc

Transmitter Output:

Low Power: 2 w

High Power: 16 w

Transmitter Audio Input Impedance: 150 ohms

Type Receiver: Double conversion superheterodyne

Receiver Audio Power Output:

Loudspeaker: 800 mw

Handset: 50 mw

Fixed Level: 20 mw

Receiver Audio Output Impedance: 600 ohms

Receiver Sensitivity: 25 μ v**Receiver-Transmitter RT-70/GRC or RT-70A/GRC:**

Frequency Range in Mc: 47 to 58.4

Type Transmission and Reception: Voice

Type Modulation: FM

Operational Range: Approximately 1 mile

Type Tuning: Continuous

Preset Detent Channels: 2

Channel Spacing: 100 kc

Transmitter Power Output: 500 mw

Transmitter Audio Input Impedance: 150 ohms at 1,000 cps

Type Receiver: Double conversion superheterodyne

Receiver Audio Output Power: 75 mw for ± 15 kc deviation at 1,000 cps

Receiver Audio Output Impedance: 600 ohms

Receiver Sensitivity: 25 db signal-to-noise ratio at 1.0 μ v ± 15 kc deviation at 1,000 cps**Power Requirements:**

Power Supply PP-282/GRC:

Input Power: 20 v to 32 vdc at 1.23 amp max

Output Power: 135 v dc at 0.118 amp

Power Supply PP-112/GR: 25.2 vdc at 7.0 amp

AN/MRC-37 RADIO SET**MAJOR COMPONENTS**

QTY	ITEM	STOCK NUMBERS	DIMENSIONS (Inches)	WEIGHT (Lbs)
1	Adapter UG-273/U	5935-149-3534	1-7/32 lg	
1	Adapter UG-306/U	5935-171-3016	1 x 7/8 x 1/2	
1	Cabinet CY-731B/MRC	6F300-731B	42-7/8 x 18-11/16 x 17-1/8	
1	Cabinet CY-732/MRC	2Z1891-732	30 x 16-1/2 x 9-7/8	
1	Cable Assembly CG-568/U	5995-255-1334	51-15/16 lg	
1	Chest Set AN/GSA-6	5965-355-7649		
1	Dynamic Loudspeaker LS-166/U	5965-243-6420	5-21/32 x 3-3/16 x 7-1/32	
3	Headset-Microphones H-63E/U	5965-237-8049		
1	Mast Base MP-65-B	5820-503-2953	18 lg x 3-1/8 dia	
1	Mast Section MS-116 or MS-116A	5985-199-8831	39-1/2 lg x 0.393 dia	
1	Mast Section MS-117 or MS-117A	5985-199-8843	39-1/2 lg x 0.373 dia	
1	Mast Section MS-118 or MS-118A	5985-199-8841	39-1/2 lg x 0.246 dia	
1	Radio Set AN/GRC-5	5820-230-0449		
1	Truck, utility, 1/4 ton	2320-204-3323		

REFERENCE DATA AND LITERATURE:

TM 11-284/TO16-30GRC3-6
 TM 11-289/TO16-35RT66-5
 TM 11-290; TM 11-898
 TM 11-5036/TO31R2-2GRC3-31
 TM 11-5038/TO16-30GRA6-5
 TM 11-5039; TM 11-5040

SHIPPING DATA

PKGS	VOLUME (Cu Ft)	WEIGHT (Lbs)
------	----------------	--------------

PROCUREMENT DATA

PROCURING SERVICE: USN
 SPEC &/or DWG:

DESIGN COG: USN

CONTRACTOR	LOCATION	CONTRACT OR ORDER NO.	APPROX UNIT COST
------------	----------	-----------------------	------------------

RADIO SET **AN/MRC-38**

25 November 1958

Cognizant Serv: **USN FSN: 5820-644-0931****USA****USN****USAF**

TYPE CLASS: --

Used by

--

STOCK NO: --

--

--

(No Illustration Available)

FUNCTIONAL DESCRIPTION:

Radio Set AN/MRC-38 is primarily designed for short-range operation within and between armored, artillery, and infantry units.

This equipment consists essentially of Radio Set AN/GRC-7 installed in a Truck M38A1. The radio set provides frequency modulated radio-telephone communications within an established frequency range.

TECHNICAL CHARACTERISTICS:**AF Amplifier AM-65/GRC:**

Input Impedance:

RT-68/GRC: 1,500 (interphone channel)

RT-70/GRC or RT-70A/GRC: 1,500 ohms (interphone channel)

RT-68/GRC and RT-70/GRC or RT-70A/GRC: 150 ohms (interphone channel)

Output Impedance: 150 ohms and 600 ohms (adjustable)

AF Response: Flat to within 4 db for frequencies between 400 and 2,500 cps with sharp cutoff beyond these limits

Radio Receiver R-110/GRC:

Frequency Range in Mc: 38 to 55

Type Receiver: Single conversion superheterodyne

Type Modulation: FM

Sensitivity: Over 25 db signal plus noise-to-noise ratio at 1/2 μ v, deviation ± 15 kc, 1,000 cps

Type of Tuning: Continuously variable and detent selection of 3 preset frequencies

Channel Spacing: 100 kc

Audio Output:

Loudspeaker: 500 mw

Earphones: 40 mw

Fixed Level: 20 mw

Audio Output Impedance: 600 ohms unbalanced

Receiver-Transmitter RT-68/GRC:

Frequency Range in Mc: 38 to 54.9

Type Transmission and Reception: Voice and 1,600 cps ringing tone

Type Modulation: FM

Operational Range:

Vehicle in Motion: 10 miles

Stationary: 15 miles

Type Tuning: Detent or preset channels or continuous tuning

Detent Channels: 170

Preset Detent Channels: 2

Channel Spacing: 100 kc

Transmitter Output:

Low Power: 2 w

High Power: 16 w

Transmitter Audio Input Impedance: 150 ohms

Type Receiver: Double conversion superheterodyne

Receiver Audio Power Output:

Loudspeaker: 800 mw

Handset: 50 mw

Fixed Level: 20 mw

Receiver Audio Output Impedance: 600 ohms

Receiver Sensitivity: 25 μ v**Receiver-Transmitter RT-70/GRC or RT-70A/GRC:**

Frequency Range in Mc: 47 to 58.4

Type Transmission and Reception: Voice

Type Modulation: FM

Operational Range: Approximately 1 mile

Type Tuning: Continuous

Preset Detent Channels: 2

Channel Spacing: 100 kc

Transmitter Power Output: 500 mw

Transmitter Audio Input Impedance: 150 ohms at 1,000 cps

Type Receiver: Double conversion superheterodyne

Receiver Audio Output Power: 75 mw for ± 15 kc deviation at 1,000 cps

Receiver Audio Output Impedance: 600 ohms

Receiver Sensitivity: 25 db signal-to-noise ratio at 1.0 μ v ± 15 kc deviation at 1,000 cps

Power Supply PP-282/GRC:

Input Power: 20 v to 32 vdc at 1.23 amp max

Output Power: 135 vdc at 0.118 amp

Power Supply PP-112/GR: 25.2 vdc at 7.0 amp

MIL-HDBK-161

AN/MRC-38 RADIO SET

MAJOR COMPONENTS

QTY	ITEM	STOCK NUMBERS	DIMENSIONS (Inches)	WEIGHT (Lbs)
1	Adapter UG-273/U	593-149-3534	1-7/32 lg	
1	Adapter UG-306/U	5935-171-3016	1 x 7/8 x 1/2	
1	Cabinet CY-731B/MRC	6F300-731B	42-7/8 x 18-11/16 x 17-1/8	
1	Cabinet CY-732/MRC	2Z1891-732	30 x 16-1/2 x 9-7/8	
1	Cable Assembly CG-568/U	5995-255-1334	51-15/16 lg	
1	Chest Set AN/GSA-6	5965-355-7649		
1	Dynamic Loudspeaker LS-166/U	5965-243-6420	5-21/32 x 3-3/16 x 7-1/32	
3	Headset-Microphone H-63E/U	5965-237-8049		
1	Mast Base MP-65-B	5820-503-2953	18 lg x 3-1/8 dia	
1	Mast Section AB-24/GR	5985-240-3720	23-1/2 lg	
1	Mast Section MS-117 or MS-117A	5985-199-8843	39-1/2 lg x 0.373 dia	
1	Radio Set AN/GRC-7	5820-230-0446		
1	Truck, utility, 1/4 ton	2320-204-3323		

REFERENCE DATA AND LITERATURE:

- TM 11-284/TO16-30GRC3-6
- TM 11-289/TO16-35RT66-5
- TM 11-290; TM 11-898
- TM 11-5036/TO31R2-2GRC3-31
- TM 11-5038/TO16-30GRA6-5
- TM 11-5039; TM 11-5040

SHIPPING DATA

PKGS	VOLUME (Cu Ft)	WEIGHT (Lbs)
------	----------------	--------------

PROCUREMENT DATA

PROCURING SERVICE: USN
SPEC &/or DWG:

DESIGN COG: USN

CONTRACTOR	LOCATION	CONTRACT OR ORDER NO.	APPROX UNIT COST
------------	----------	-----------------------	------------------

RADIO SET AN/MRC-41

25 November 1958

Cognizant Serv: USAF FSN:

	USA	USN	USAF
TYPE CLASS:	--	--	Std
STOCK NO:	--	--	--

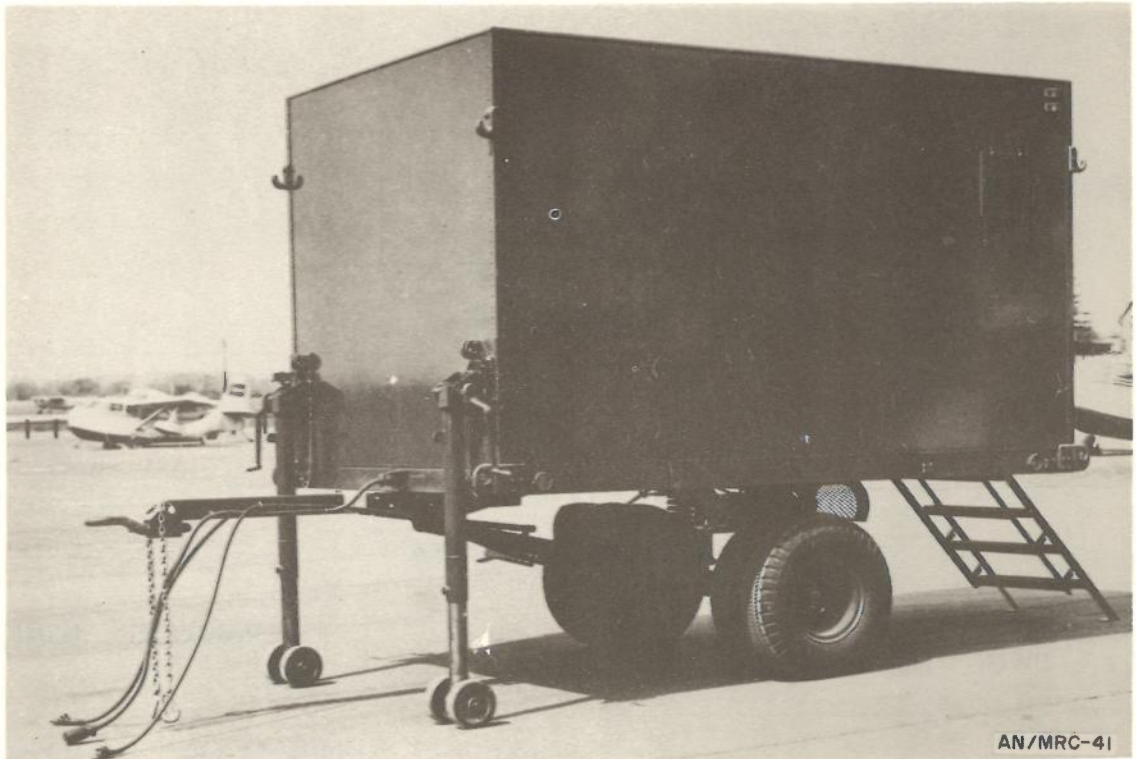

AN/MRC-41

FUNCTIONAL DESCRIPTION:

Radio Set AN/MRC-41 is a highly mobile, air-transportable, radio relay unit capable of independent operation. It may also be employed with other mobile or permanent com-center facilities to provide ground-to-ground or point-to-point communication.

This equipment is used either as a relay or terminal station in continuous wave, voice, and diversity radioteletype communication. It is normally operated with Teletypewriter Central Office AN/MGC-2, Radio Receiving Set AN/MRR-5, and Radio Transmitting Set AN/MRT-6.

All operating components are installed and operated from Van Trailer V-83/M.

Power is supplied by trailer mounted Diesel Engine Generator Set Type MB-5; however, this item is not supplied as part of the radio set.

TECHNICAL CHARACTERISTICS:

Frequency Range in Mc: 230 to 250

Type Modulation: FM (F3, F9)

Type Signal: Cw, voice, fsk

Power Output:

Receiver: .5 w

Transmitter: 5 w

Power Requirements: 20 to 30 kw; 120- or 240-v, 50- to 60-cycle 1-phase ac

MIL-HDBK-161

AN/MRC-41 RADIO SET

MAJOR COMPONENTS

QTY	ITEM	STOCK NUMBERS	DIMENSIONS (Inches)	WEIGHT (Lbs)
8	Converter Signal TA-182/U			
4	Converter, vf carrier			
4	Keyer, vf carrier			
4	Set, Network (2 ea ± 120 cps)			
1	Radio Relay Set AN/TRC-12B			
1	Terminal, Telephone AN/TCC-3			

REFERENCE DATA AND LITERATURE:

SHIPPING DATA

PKGS	VOLUME (Cu Ft)	WEIGHT (Lbs)
1	1,150	8,000

PROCUREMENT DATA

PROCURING SERVICE: USAF
SPEC &/or DWG: MIL-R-9523

DESIGN COG: USAF, RCSG

CONTRACTOR	LOCATION	CONTRACT OR ORDER NO.	APPROX UNIT COST
------------	----------	--------------------------	---------------------

RADIO SET AN/MRC-59

25 November 1958

Cognizant Serv: USN FSN:

	USA	USN	USAF
TYPE CLASS:	--	Used by	--
STOCK NO:	--	--	--

(No Illustration Available)

FUNCTIONAL DESCRIPTION:

Radio Set AN/MRC-59 is a transportable communication equipment designed for mounting in a 1/4 ton vehicle.

This equipment is not intended to be operated while the vehicle is in motion.

TECHNICAL CHARACTERISTICS:

Frequency Range in Mc: 4,400 to 5,000

Type of Emission and Reception: P9F

Bandwidth: 3kc

Power Output: 3 w peak

Power Requirements: 110-v 400-cycle 1-phase ac

MAJOR COMPONENTS

QTY	ITEM	STOCK NUMBERS	DIMENSIONS (Inches)	WEIGHT (Lbs)
1	Antenna AS-682/TRC-27			
1	Converter			
1	Engine generator			
1	Motor generator			
2	Multiplexer TD-101/TRC-27			
1	Radio Set AN/MRC-59			
1	Receiver-Transmitter RT-252/ TRC-27			

REFERENCE DATA AND LITERATURE:

SHIPPING DATA

PKGS	VOLUME (Cu Ft)	WEIGHT (Lbs)

MIL-HDBK-161

AN/MRC-59 RADIO SET

PROCUREMENT DATA

PROCURING SERVICE: USN
SPEC &/or DWG:

DESIGN COG: USN, BuShips

CONTRACTOR

LOCATION

CONTRACT OR
ORDER NO.

APPROX
UNIT COST

RADIO SET **AN/MRC-60**

25 November 1958

Cognizant Serv: **USN FSN:****USA****USN****USAF**

TYPE CLASS: --

Used by --

STOCK NO: --

(No Illustration Available)**FUNCTIONAL DESCRIPTION:**

Radio Set AN/MRC-60 is a transportable communication equipment designed to be mounted in a shelter; the shelter itself is mounted on a 3/4-ton truck.

This equipment is not intended to be operated while the vehicle is in motion.

The essential power equipment is carried on a 3/4-ton trailer.

TECHNICAL CHARACTERISTICS:

Frequency Range in mc: 4,400 to 5,000

Type of Emission and Reception: P9F

Number of Channels: 32

Bandwidth of Each Channel: 3kc

Power Output: 3 w peak

Power Requirements: 115-v 400-cycle 1-phase ac

MAJOR COMPONENTS

QTY	ITEM	STOCK NUMBERS	DIMENSIONS (Inches)	WEIGHT (Lbs)
4	Antenna AS-682/TRC-27			
2	Engine generator			
4	Mast AB-357/TRC-27			
4	Motor generator			
8	Multiplexer TD-101/TRC-27			
4	Receiver-Transmitter RT-252/ TRC-27			
1	Shelter S-110/U			
1	Trailer M-101, 3/4 ton			
1	Truck M-37, 3/4 ton			

REFERENCE DATA AND LITERATURE:**SHIPPING DATA**

PKGS	VOLUME (Cu Ft)	WEIGHT (Lbs)

MIL-HDBK-161

AN/MRC-60 RADIO SET

PROCUREMENT DATA

PROCURING SERVICE: USN
SPEC &/or DWG:

DESIGN COG: USN, BuShips

CONTRACTOR	LOCATION	CONTRACT OR ORDER NO.	APPROX UNIT COST
------------	----------	--------------------------	---------------------

RADIO SET AN/MRC-62

25 November 1958

Cognizant Serv: USN FSN: 5820-519-5524

USA

USN

USAF

TYPE CLASS: --

Used by --

STOCK NO: --

(No Illustration Available)

FUNCTIONAL DESCRIPTION:

Radio Set AN/MRC-62 is a communication system combining transmitter, receiver, and power unit. It provides a terminal facility for receiving and transmitting multichannel voice, telegraph, and/or facsimile when used with appropriate terminal apparatus.

This equipment is contained in Shelter S-110/U which is mounted on a 1/4-ton Truck M-37. Facilities are provided to permit detaching of the shelter for lift by rotary wing aircraft over water during amphibious operations or over mountainous terrain.

Power Unit PE-75 is mounted in Trailer M-101 and provides the necessary power source.

TECHNICAL CHARACTERISTICS:

Radio Transmitter T-235/GRC-10:

Frequency Range in mc: 54 to 70.9

Type Signal: Voice, multichannel telephone, telegraph or facsimile; singly or in combination

Type Modulation: FM

Operational Range:

High Power: 20 to 50 miles*Low Power:* 5 to 15 milesMaximum Frequency Deviation: ± 40 kc

Power Output:

High Power: 40 w*Low Power:* 10 w

Output Impedance: 50 ohms (at antenna receptacle)

Radio Receiver R-125/GRC-10:

Frequency Range in mc: 54 to 70.9

Type Receiver: Double conversion superheterodyne

Type Signals: FM, ± 40 kc maximum deviation

Frequency Control: Crystal and automatic frequency control

Sensitivity: 0.5 μ v signal input for 10 db signal-plus-noise ratio*Antenna Group OA-249/GRC-10:*

Frequency Range in mc: 54 to 71 inclusive

Characteristic Impedance: 52 ohms

Antenna Type: Yagi

Power Requirements: 292 w 115- or 230-v 60- to 65-cycle or 326 w 26 v dc

MAJOR COMPONENTS

QTY	ITEM	STOCK NUMBERS	DIMENSIONS (Inches)	WEIGHT (Lbs)
8	Adapter Connectors UG-567A/U	5935-636-6236		
1	Antenna Group OA-249/GRC-10	5985-503-0650		
4	Base, Telegraph-Telephone Signal Converter MT-791/U	5805-186-9464		
2	Control, Radio Set C-632/GRC-10	5820-505-0724		
4	Converter, Telegraph-Telephone Signal TA-182/U	5805-263-3326		
1	Dummy Load, Electrical DA-73/U	5985-264-7480		
2	Dynamotor Power Supply Type DY-94/GRC-10	6125-392-7183		
1	Generator Set, Gasoline Engine, Trailer Mounted PU-357/MRC	6115-553-0554		

MIL-HDBK-161

AN/MRC-62 RADIO SET

MAJOR COMPONENTS—Continued

QTY	ITEM	STOCK NUMBERS	DIMENSIONS (Inches)	WEIGHT (Lbs)
2	Handset H-33E/PT	5965-163-9947		
2	Loudspeaker, Dynamic LS-166/U	5965-243-6420		
1	Multimeter TS-352B/U	6625-553-0142		
2	Rack, Electrical Equipment MT-700/GRC-10	5820-503-3465		
2	Radio Receiver R-125/GRC-10	5820-503-1244		
1	Shelter, Electrical Equipment S-110/U	5410-641-3237		
1	Terminal, Telephone AN/ TTC-3	5805-503-2648		
2	Transmitter, Radio T-235/ GRC-10	5820-503-3420		
1	Truck, Cargo 3/4 ton, 4 x 4 Type M-37	2320-835-8323		

REFERENCE DATA AND LITERATURE:

- TM 11-614
- TM 11-900
- TM 11-2137
- TM 11-2142
- TM 11-5527A

SHIPPING DATA

PKGS	VOLUME (Cu Ft)	WEIGHT (Lbs)
------	----------------	--------------

PROCUREMENT DATA

PROCURING SERVICE: USN
SPEC &/or DWG:

DESIGN COG: USN, BuShip

CONTRACTOR	LOCATION	CONTRACT OR ORDER NO.	APPROX UNIT COST
------------	----------	--------------------------	---------------------

RADIO SET **AN/MRC-63**

25 November 1958

Cognizant Serv: USN FSN: 5820-519-5525

USA

USN

USAF

TYPE CLASS: --

Used by --

STOCK NO: --

(No Illustration Available)

FUNCTIONAL DESCRIPTION:

Radio Set AN/MRC-63 is a communication system combining transmitter, receiver, and power units. It provides a terminal facility for receiving and transmitting multichannel voice, telegraph, and/or facsimile when used with appropriate terminal apparatus.

This equipment is contained in Shelter S-110/U mounted on a 1/4-ton Truck M-37. Facilities are provided to permit detaching of the shelter for rotary wing aircraft lift over water during amphibious operations or over mountainous terrain.

Power Unit PE-75 is mounted in Trailer M-101 and provides the necessary power source.

The set is similar to Radio Set AN/MRC-62 except for the number of major components.

TECHNICAL CHARACTERISTICS:

Radio Transmitter T-235/GRC-10:

Frequency Range in mc: 54 to 70.9

Type Signal: Voice, multichannel telephone, telegraph or facsimile; or a combination of these.

Type Modulation: FM

Operational Range:

High Power: 20 to 50 miles

Low Power: 5 to 15 miles

Maximum Frequency Deviation: ± 40 kc

Power Output:

High Power: 40 w

Low Power: 10 w

Output Impedance: 50 ohms (at antenna receptacle)

Radio Receiver R-125/GRC-10:

Frequency Range in mc: 54 to 70.9

Type Receiver: Double conversion superheterodyne

Type Signal: FM; ± 40 kc maximum deviation

Frequency Control: Crystal and automatic frequency control

Sensitivity: 0.5 μ v signal input for 10 db signal-plus-noise ratio

Antenna Group OA-249/GRC-10:

Frequency Range in mc: 54 to 71 inclusive

Characteristic Impedance: 52 ohms

Antenna Type: Yagi

Power Requirements: 292 w; 115- or 230-v, 60- to 65-cycle ac; or 326 w, 26 v dc

MAJOR COMPONENTS

QTY	ITEM	STOCK NUMBERS	DIMENSIONS (Inches)	WEIGHT (Lbs)
10	Adapter Connector UG-567A/U	5935-636-6236		
2	Antenna Group OA-249/GRC-10	5985-503-0650		
3	Control, Radio Set C-632/GRC-10	5820-505-0724		
1	Dummy Load, Electrical DA-73/U	5985-264-7480		
3	Dynamotor, Power Supply DY-94/GRC-10	6125-392-7183		
1	Generator Set, Gasoline Engine, Trailer Mounted PU-357/MRC	3H2444-3		
3	Handset H-33E/PT	5965-163-9947		
2	Loudspeaker, Dynamic LS-166/U	5965-243-6420		

RADIO SET **AN/MRC-type**

1 July 1958

Cognizant Serv: USA FSN: 5820-355-8124

SCR-399

USA

USN

USAF

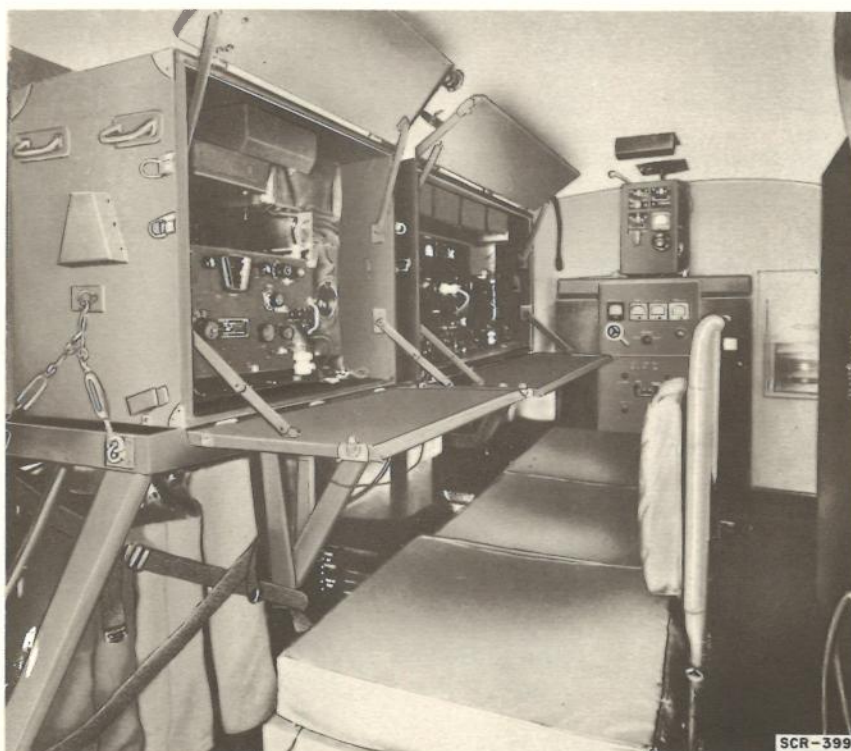
TYPE CLASS:
STOCK NO:Std
2S399Used by
--Std
--**FUNCTIONAL DESCRIPTION:**

Radio Set SCR-399 is a field, mobile, transmitting and receiving station used for AM voice, tone, or cw communication, over medium or long distances, in the medium- and high-frequency ranges.

This equipment consists of transmitting, receiving, control, and related components installed within Shelter HO-17, which is carried on a 2-1/2-ton, 6 x 6 cargo truck, and can operate on the move or at the halt.

It includes remote-control components by means of which the equipment can be operated from locations up to 2 miles away, over a telephone pair, in conjunction with Telephone EE-8.

It can be used in the 1-mc range by means of Frequency Conversion Kit MC-509.

It uses vehicular whip-type antenna systems. At the halt, when the operating range must be extended, it can be used with more elaborate arrays, such as doublet systems.

A trailer-drawn, 5-kw power unit is included to provide power for this set.

Radio Set SCR-499 is the air-transportable version of this equipment.

TECHNICAL CHARACTERISTICS:*Frequency Range in mc:*

Transmitting: 2 to 18

Receiving: 1.5 to 18

Type Modulation: AM*Type of Signal:* Voice, tone, or cw*Power Output:*

Voice: 300 w

Cw: 400 w

Power Requirements: 2,500 w 115-v 60-cycle ac (supplied by PE-95 or equivalent); and 12-v storage battery

MIL-HDBK-161

AN/MRC-type RADIO SET

MAJOR COMPONENTS

QTY	ITEM	STOCK NUMBERS	DIMENSIONS (Inches)	WEIGHT (Lbs)
		(USA)		
1	Antenna Tuning Unit BC-939	2C527-939		
1	Power Unit PE-95-G	3H4595G	75-1/2 x 28-1/2 x 38-1/2	1,545
1	Radio Receiver BC-312	2C4312	10 x 9-1/16 x 18-1/16	58.0
1	Radio Receiver BC-342	2C4342	10 x 9-1/16 x 18-1/16	61.5
1	Radio Transmitter BC-610-()	2C6500	32-5/8 x 21-3/8 x 39-7/8	452
1	Shelter HO-17	3Z7700-17	159 x 92 x 80	7,255
1	Speech Amplifier BC-614-E	2C214E	16 x 9-1/4 x 11	

REFERENCE DATA AND LITERATURE:

TM 11-281

SHIPPING DATA

PKGS	VOLUME (Cu Ft)	WEIGHT (Lbs)
2	895	10,025

PROCUREMENT DATA

PROCURING SERVICE: USA
SPEC &/or DWG: (USA)71-1683A

DESIGN COG: USA, Sig C

CONTRACTOR	LOCATION	CONTRACT OR ORDER NO.	APPROX UNIT COST
Detrola Corp.	Chicago, Ill.	30203-P-43-02	
The Hallicrafters Co.	Chicago, Ill.	3464-P-52-06	\$6,935.29

RADIO SET **AN/MRC-type**

1 July 1958

Cognizant Serv: USA FSN: 5820-193-8836

SCR-694-()

USA

USN

USAF

TYPE CLASS:

L/Std

Used by

--

STOCK NO:

2S694/6-12-24

--

--

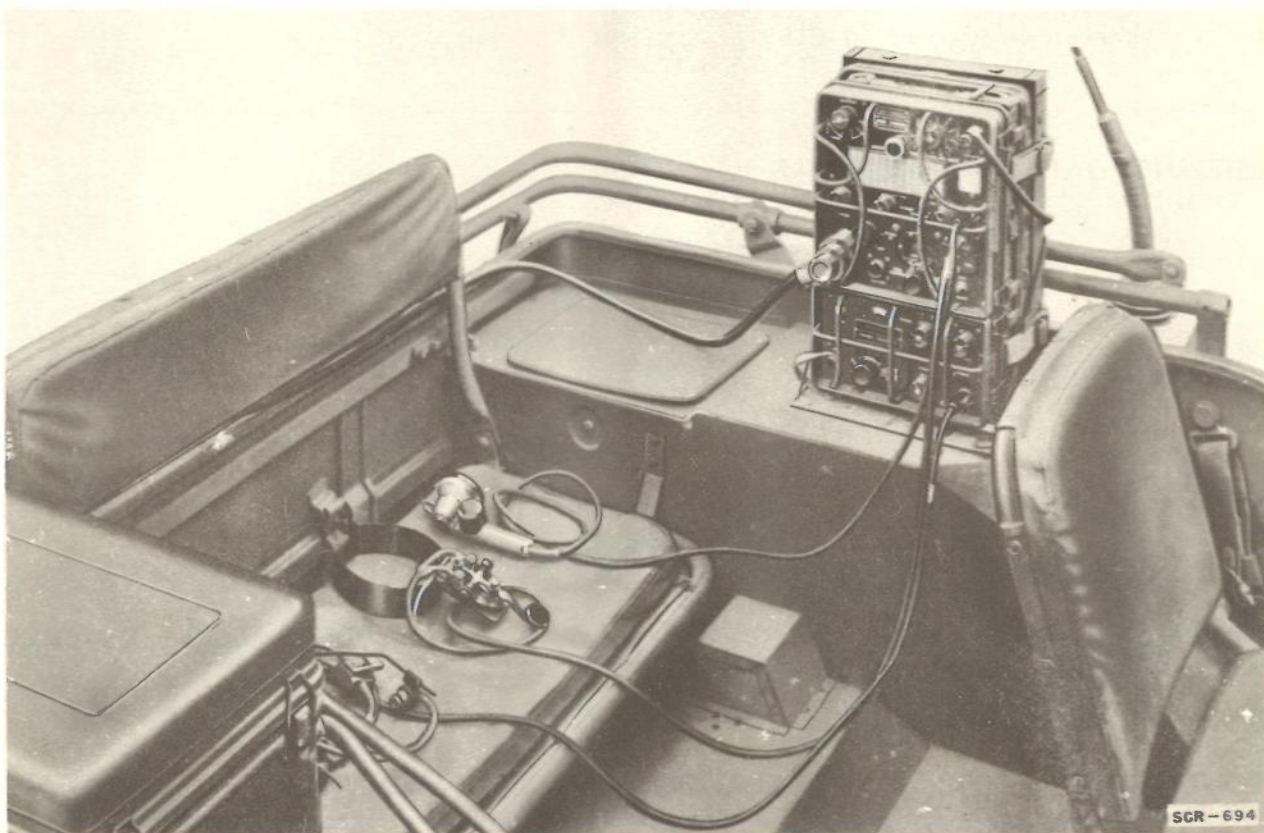
**FUNCTIONAL DESCRIPTION:**

Radio Set SCR-694-() is a lightweight, portable, crystal-controlled, AM (voice, tone, and cw) equipment used for front-line communication, and as a command set that can be installed on the ground or in vehicles.

This equipment consists of a radio transmitter-receiver, a power supply, a hand-operated generator, and related accessories. The watertight case and waterproof metal cover permit floating this set ashore as in amphibious operations.

It uses a whip-type or half-wave horizontal antenna and

has a 3-position frequency-band switch.

This set has been replaced by Radio Set AN/GRC-9.

TECHNICAL CHARACTERISTICS:

Frequency Range in mc: 4.8 to 6.5

Type Modulation: AM

Type of Signal: Cw and voice

Power Output: 8.5, 14, and 17 w

Power Requirements: 6/12/24-v dc from storage battery; or hand Generator GN-58.

MIL-HDBK-161

AN/MRC-type RADIO SET

MAJOR COMPONENTS

QTY	ITEM	STOCK NUMBERS	DIMENSIONS (Inches)	WEIGHT (Lbs)
1	Generator GN-58	(USA) 3H2358	8 x 6 x 6	
1	Radio Receiver and Transmitter BC-1306	(FSN) 5820-197-3274 (USA) 2C5395-1306	14-1/2 x 9 x 5	27
1	Vibrator Power Supply PE-237	(FSN) 5820-252-5503 (USA) 3H6800-237	11 x 20-3/16 x 9-15/16	

REFERENCE DATA AND LITERATURE:

TM 11-230C

SHIPPING DATA

PKGS	VOLUME (Cu Ft)	WEIGHT (Lbs)
	7.5	250

PROCUREMENT DATA

PROCURING SERVICE: USA
SPEC &/or DWG: (USA) 271-1606

DESIGN COG: USA, Sig C

CONTRACTOR	LOCATION	CONTRACT OR ORDER NO.	APPROX UNIT COST
------------	----------	--------------------------	---------------------

RADIO RECEIVING SET AN/MRR-4()

1 July 1958

Cognizant Serv: USA FSN: 5820-546-6505

USA

USN

USAF

TYPE CLASS: S/Std
 STOCK NO: 2C4028-4



FUNCTIONAL DESCRIPTION:

Radio Receiving Set AN/MRR-4() is a transportable voice, cw, and radioteletype receiving station for (a) aural monitoring, (2) magnetic tape recording of broadcasts, either picked up by radio receivers or transmitted over landline, (3) receiving programs of remote origin for direct rebroadcast, (4) receiving programs, or other information by radioteletype circuits, and (5) sending and receiving information by a landline teletypewriter system.

This equipment, consisting of a radio receiving and a radio-teletype shelter, normally functions as the receiving terminus for Radio Transmitting Set AN/MRT-5. It includes push-button and patch-board facilities that enable rapid connection of system components to the AN/MRT-5 or similar radio stations. The shelters, which house all of the operating components except the power units, include panoramic indicators, a teletypewriter, a perforator transmitter, radio receivers, magnetic tape recorders, telephones, and accessories.

The two shelters are powered by trailer-drawn, 10-kw power units and are readily transported by standard 6 x 6 trucks.

The AN/MRR-4 and AN/MRR-4A are functionally identical and all components are interchangeable.

TECHNICAL CHARACTERISTICS:

Frequency Range in mc: 0.1 to 0.4, 1.35 to 29.4 in 6 bands (Hammarlund revr Mod SP-600-JLX); 0.54 to 54 in 6 bands

(R-274A/FRR)

Type Modulation: AM

Type of Signal: Cw, tone, voice, radioteletype

Power Requirements: 130 w, 115-v 60-cycle ac (except for battery-operated telephone system)

MAJOR COMPONENTS

QTY	ITEM	STOCK NUMBERS	DIMENSIONS (Inches)	WEIGHT (Lbs)
2	Power Unit PE-95-6			
1	Radio Receiving Shelter MO-4027	-----	81 x 78 x 145	4,215
1	Radio Teletypewriter Shelter MO-4026	-----	81 x 78 x 145	4,863

MIL-HDBK-161

AN/MRR-4() RADIO RECEIVING SET

REFERENCE DATA AND LITERATURE:

TM 11-646

SHIPPING DATA

PKGS	VOLUME (Cu Ft)	WEIGHT (Lbs)
2	530.1	8,898

PROCUREMENT DATA

PROCURING SERVICE: USA
SPEC &/or DWG: MIL-R-11601

DESIGN COG: USA, Sig C

CONTRACTOR	LOCATION	CONTRACT OR ORDER NO.	APPROX UNIT COST
Gates Radio Co.	Quincy, Ill.	11655-P-52-93	\$26,112.66

RADIO RECEIVING SET **AN/MRR-5**

25 November 1958

Cognizant Serv: USAF FSN: 5895-505-1041B

USA

USN

USAF

TYPE CLASS:

STOCK NO:

--

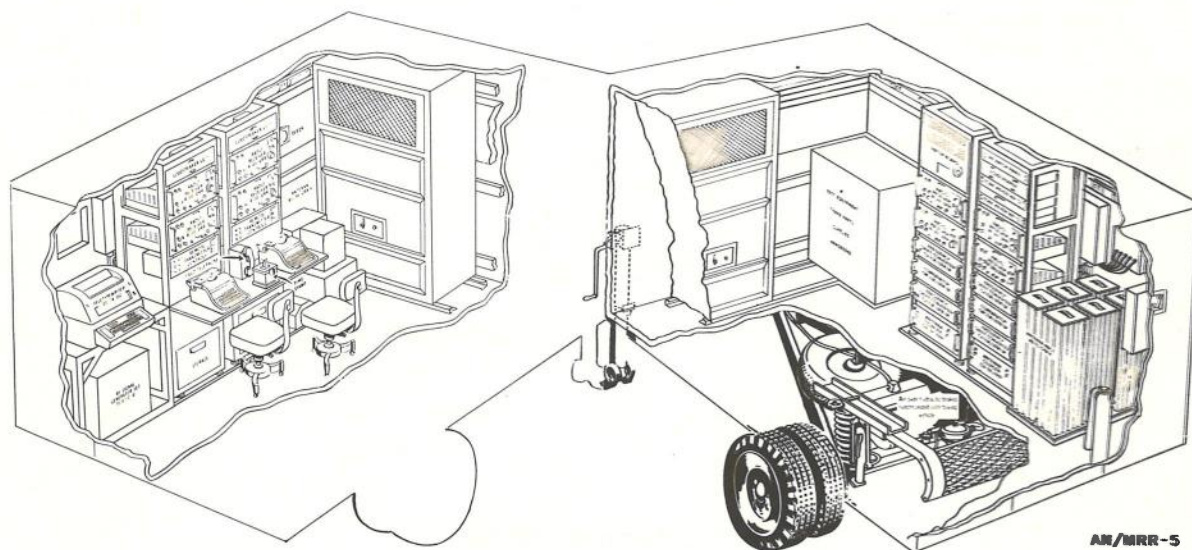
1760-048640030

AN/MRR-5

FUNCTIONAL DESCRIPTION:

Radio Receiving Set AN/MRR-5 is a highly mobile, air-transportable equipment designed to operate with other mobile or permanent communication centers, as a part of a ground-to-air or point-to-point communications system.

This equipment has remote controls for operating Radio Transmitting Set AN/MRT-6 and is suitable for operation with Radio Beacon AN/URN-5, Radio Transmitting Set AN/URT-7, and Radio Transmitting Equipment TED-2. It is normally used with Teletypewriter Central Office AN/MGC-2, Radio Set AN/MRC-41, and Radio Transmitting Set AN/MRT-6.

All operating components are installed in and are operated from Van Trailer V-83/M.

Power is supplied by Trailer-Mounted Diesel Engine Generator Set Type MB-5, which is not supplied as part of the set or of commercial facilities.

TECHNICAL CHARACTERISTICS:

Frequency Range in mc: 0.5 to 30.5

Coverage: Continuous

Tuning Steps: 30

Type Modulation: AM (A1, A2, A3); FM (F1)

Type Emission: Cw, tone, voice, fsk

Power Output: 1.5 w; 4 or 600 ohms

Power Requirements: 20 kw to 30 kw; 120- or 240-v 50- to 60-cycle 1-phase ac

MAJOR COMPONENTS

QTY	ITEM	STOCK NUMBERS	DIMENSIONS (Inches)	WEIGHT (Lbs)
2	Antenna Coupler CU-168/ FRR	5985-539-7961		
3	Antenna Group AN/GRA-4			

MIL-HDBK-161

AN/MRR-5 RADIO RECEIVING SET

MAJOR COMPONENTS—Continued

QTY	ITEM	STOCK NUMBERS	DIMENSIONS (Inches)	WEIGHT (Lbs)
2	Frequency Shift Converter- Comparator NR-174	5815-505-3338		
8	Radio Receiver R-388/URR	5820-537-3985	10-1/2 x 19 x 13-11/16	35
2	Remote Transmitter Controls			
1	Teletypewriter TT-70A/UG	1730-NL-7693		

REFERENCE DATA AND LITERATURE:

TO 31R2-2MRR5-1, -2, -4

SHIPPING DATA

PKGS	VOLUME (Cu Ft)	WEIGHT (Lbs)
1	1,150	8,000

PROCUREMENT DATA

PROCURING SERVICE: USAF
SPEC &/or DWG: MIL-R-9518

DESIGN COG: USAF, RCSG

CONTRACTOR	LOCATION	CONTRACT OR ORDER NO.	APPROX UNIT COST
Craig Systems, Inc.	90 Holton St., Danvers, Mass.		

RADIO RECEIVING SET **AN/MRR-6**

25 November 1958

Cognizant Serv: USAF FSN:

	USA	USN	USAF
TYPE CLASS:	--	--	Tent-Std
STOCK NO:	--	--	--

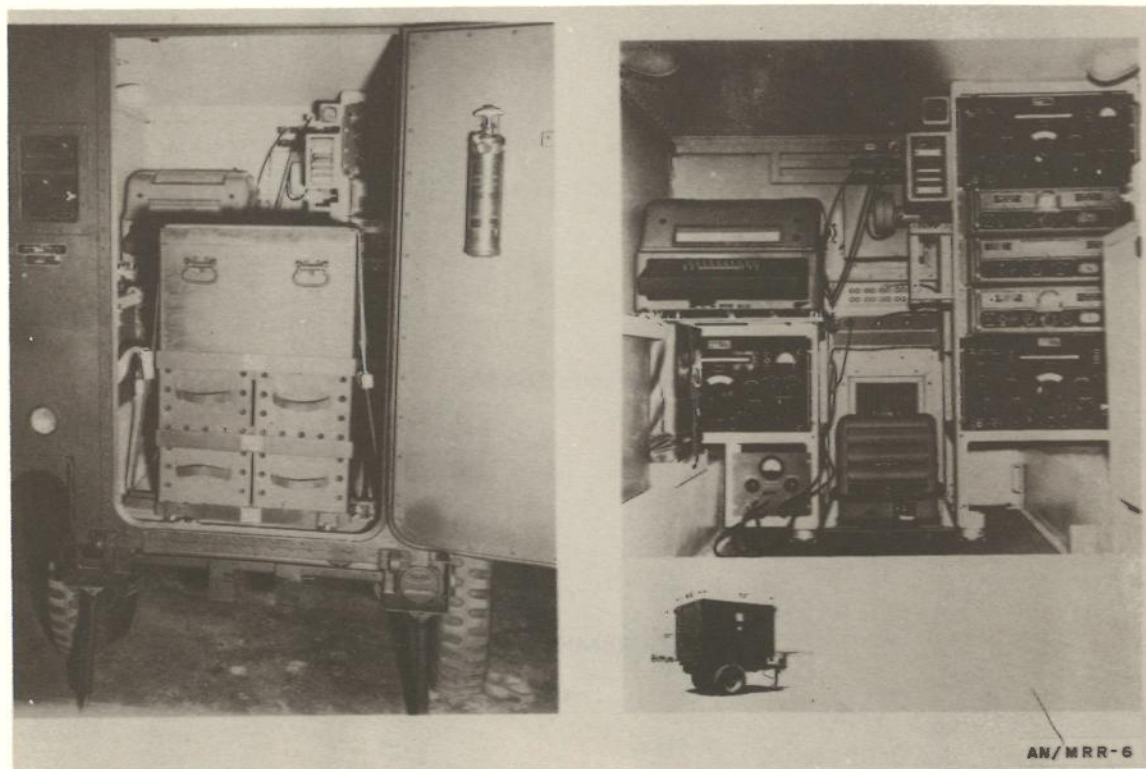
**FUNCTIONAL DESCRIPTION:**

Radio Receiving Set AN/MRR-6 is a highly mobile and air-transportable equipment designed for reception and printing of radioteletype signals transmitted by the frequency-shift method or by voice and continuous wave signals. It is employed in short duration (up to three months) for emergency support of Airways and Air Communications Service air operations.

This equipment includes remote controls for operation of Radio Transmitting Set AN/MRT-7 and can receive radio teletype signals through Frequency Shift Converter-Comparator, Northern Radio Type 174, operating with Teletypewriter TT-70/UG.

Radio Receiving Set AN/MRR-6 is usually operated with Air Traffic Control Set AN/MRN-15, Radio Transmitting Set AN/MRT-7, and Facsimile Set AN/MXR-1.

All operating components are installed in and operated from a trailer van.

Power is supplied by Trailer Mounted Diesel Engine Generator Set MB-6; however, this item is not supplied as part of the set.

TECHNICAL CHARACTERISTICS:

Frequency Range in mc: 0.5 to 30.5

Coverage: Continuous

Tuning Steps: 30

Type Modulation: AM (A1, A2, A3); FM (F1)

Type Emission: Cw, tone, voice, fsk

Power Output: 1.5 w; 600 ohms

Power Requirements: 5 kw; 240-v 50- to 63-cycle 3-wire 1-phase ac

MIL-HDBK-161

AN/MRR-6 RADIO RECEIVING SET

MAJOR COMPONENTS

QTY	ITEM	STOCK NUMBERS	DIMENSIONS (Inches)	WEIGHT (Lbs)
1	Frequency Shift Converter- Comperator NR-174	5815-505-3338		
4	Mast AB-86/GRA-4			
3	Radio Receiver R-388/URR	5820-537-3985	10-1/2 x 19 x 13-11/16	35
1	Rectifier Power Unit RA-133			
1	Shelter w/trailer mounting chassis			
1	Teletypewriter TT-70/UG	1730-NL-7693		

REFERENCE DATA AND LITERATURE:

SHIPPING DATA

PKGS	VOLUME (Cu Ft)	WEIGHT (Lbs)
1	341.6	3,200 (approx)

PROCUREMENT DATA

PROCURING SERVICE: USAF
SPEC &/or DWG: RADC-2448

DESIGN COG: USAF, RCUE

CONTRACTOR	LOCATION	CONTRACT OR ORDER NO.	APPROX UNIT COST
------------	----------	--------------------------	---------------------

RADIO TRANSMITTING SET AN/MRT-5()

1 July 1958

Cognizant Serv: USA FSN: 5820-503-2635

USA

USN

USAF

TYPE CLASS: S/Std
 STOCK NO: 2C6912-5

FUNCTIONAL DESCRIPTION:

Radio Transmitting Set AN/MRT-5() is a transportable radio station that provides complete radio transmission facilities in the standard AM broadcast band. This equipment, when used with Radio Receiving Set AN/MRR-4(), is a complete radio station for dissemination of information for entertainment and psychological warfare services.

All operating components, with the exception of the two power units and the antennas, are housed in the transmitting trailer, the studio trailer, and the antenna tuning shelter. The transmitting trailer supplies facilities for generating, amplifying, and transmitting the rf carrier; and the studio trailer, for all local programming. The antenna tuning shelter provides for tuning the antenna and feeding the modulated rf to the mast antenna or the balloon-carried antenna. Provisions are made for transmitting programs originated at a remote point.

Main power for the transmitting trailer and the antenna tuning shelter is furnished by Power Unit PE-85/M; and for the studio trailer, by Power Unit PE-95-G.

The AN/MRT and AN/MRT-5A differ somewhat; a variable-frequency oscillator and Radio Receiver R-388/URR are added to the transmitting trailer of the A model.

TECHNICAL CHARACTERISTICS:

Frequency Range in Mc: 0.54 to 1.6

Type Modulation: AM

Type of Signal: Voice

Power Output: 5 kw

Power Requirements:

Transmitter: 15.5 kw, 230-v 60-cycle 3-phase ac

Studio Shelter: 115-v 60-cycle 1-phase ac



AN/MRT-5

MAJOR COMPONENTS

QTY	ITEM	STOCK NUMBERS	DIMENSIONS (Inches)	WEIGHT- (Lbs)
		(FSN)		
1	Antenna Tower AB-127()/ FR	5450-223-6202	180 ft high	
1	Antenna tuning shelter	-----	82 x 78 x 145	
1	Studio trailer	-----	95-1/2 x 131-3/4 x 318	
1	Transmitting trailer	-----	95-1/2 x 131-3/4 x 318	

MIL-HDBK-161

AN/MRT-5() RADIO TRANSMITTING SET

REFERENCE DATA AND LITERATURE:

TM 11-643

SHIPPING DATA

PKGS	VOLUME (Cu Ft)	WEIGHT (Lbs)
------	----------------	--------------

PROCUREMENT DATA

PROCURING SERVICE: USA
SPEC &/or DWG: MIL-R-11601

DESIGN COG: USA, Sig C

CONTRACTOR	LOCATION	CONTRACT OR ORDER NO.	APPROX UNIT COST
Gates Radio Co.	Quincy, Ill.	101-P-52-93	\$85,514.7

RADIO TRANSMITTING SET AN/MRT-6

25 November 1958

Cognizant Serv: USAF FSN:

USA

USN

USAF

TYPE CLASS:

--

--

Std

STOCK NO:

--

--

1760-049587233

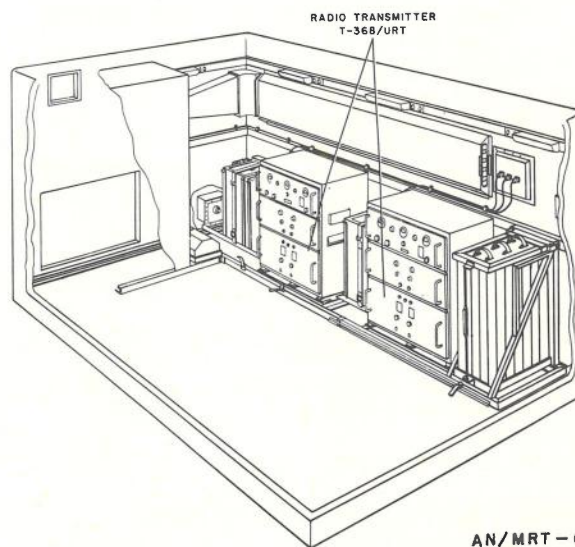
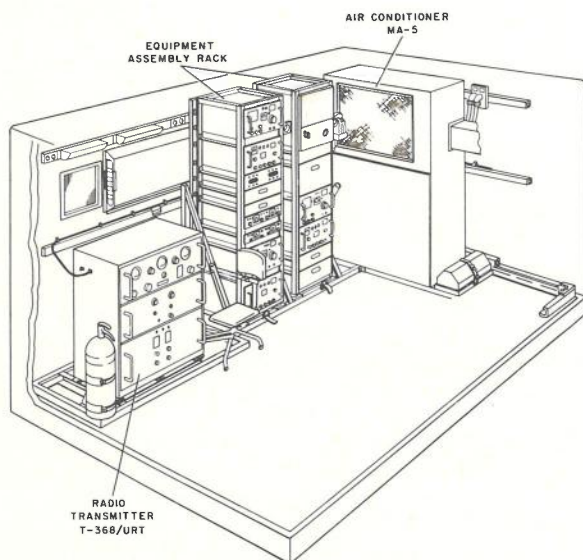

AN/MRT-6

FUNCTIONAL DESCRIPTION:

Radio Transmitting Set AN/MRT-6 is a mobile, air-transportable, high frequency transmitting station that is used for ground-to-air and point-to-point radio transmission. The facility is entirely self-contained, except for primary power, and may be operated independently or in conjunction with other airport communication equipment.

Various components of this set may be remotely controlled by Radio Receiving Set AN/MRR-5.

This equipment is normally operated with Teletypewriter Central Office AN/MGC-2, Radio Set AN/MRC-41, and Radio Receiving Set AN/MRR-5, and is installed in and operated from Van Trailer V-83/M.

Power is supplied by Trailer Mounted Diesel Engine Generator Set Type MB-5; however, this item is not supplied as part of the set. Where available, commercial power may be used.

TECHNICAL CHARACTERISTICS:

Frequency Range in Mc: 1.5 to 20

Number of Bands: 5

Type Modulation: AM, FM

Type Emission: Cw, tone, voice, fsk (A1, A2, A3, F1)

Power Output: 375 w (voice; 475 w (cw)

Power Requirements: 20 kw to 30 kw; 120- or 240-v 50- to 60-cycle 1-phase ac

MAJOR COMPONENTS

QTY	ITEM	STOCK NUMBERS	DIMENSIONS (Inches)	WEIGHT (Lbs)
3	Antenna Coupler Type TAC-1	1760-049-685-100		
3	Antenna Tuning Unit Model TAC			
1	Carbon Microphone M-15/UR			
1	Equipment Frame 76R31			

MIL-HDBK-161

AN/MRT-6 RADIO TRANSMITTING SET

MAJOR COMPONENTS—Continued

QTY	ITEM	STOCK NUMBERS	DIMENSIONS (Inches)	WEIGHT (Lbs)
1	Equipment Rack 76d12			
1	Equipment Rack 76d13			
2	Frequency Shift Converter NR Type 152	5820-508-2175		
3	Frequency Shift Keyer, Model XFK			
2 sets	Frequency determining network			
1	Headset HS-33A			
3	Mast AB-86/GRA-4	5985-244-5147		
3	Oscillator, variable-frequency			
1	Panel, Patch, Communication SB-502/M			
3	Radio Transmitter T-368/ URT			
1	RF Patch Panel 76G37			
1	Terminal Box J-741/M			
3	Transmitter control assembly			
1	Trailer, van V-83M	83R145		

REFERENCE DATA AND LITERATURE:

TO 31R2-2MRT6-1, -2, -4

SHIPPING DATA

PKGS	VOLUME (Cu Ft)	WEIGHT (Lbs)
1	1,150	8,000 (approx)

PROCUREMENT DATA

PROCURING SERVICE: USAF
SPEC &/or DWG: MIL-T-9519

DESIGN COG: USAF, RCSG

CONTRACTOR	LOCATION	CONTRACT OR ORDER NO.	APPROX UNIT COST
Craig Systems, Inc.	Danvers, Mass.		

RADIO TRANSMITTING SET AN/MRT-7

25 November 1958

Cognizant Serv: USAF FSN:

	USA	USN	USAF
TYPE CLASS:	--	--	Tent-Std
STOCK NO:	--	--	1760-049587237

(No Illustration Available)

FUNCTIONAL DESCRIPTION:

Radio Transmitting Set AN/MRT-7 is an air-transportable, mobile, high frequency equipment used to transmit voice, frequency-shift telegraph, and intermediate frequency beacon signals. It is suitable for worldwide communication use and in short-duration (3 months) emergency support applications of Airways and Air Communications Service operations.

This equipment can be operated by remote control from Radio Receiving Set AN/MRR-6. It is used with Air Traffic Control Set AN/MRN-15, Radio Receiving Set AN/MRR-6, and Facsimile Set AN/MXR-1.

All operating components are installed in and operated from a trailer van. Power for operation is derived from

Trailer-Mounted Diesel Engine Generator Type MB-6; however, this item is not supplied as part of the radio transmitting set.

TECHNICAL CHARACTERISTICS:

Frequency Range in Mc: 0.2 to .4; 1.5 to 15

Type Modulation: AM, FM

Type Emission: A1, A2, A3, F1 (Cw, tone, voice, fsk)

Power Output:

A2, A3: 15 w

A2, A3: 50 w

A1, F1: 75 w

Power Requirements: 5 kw; 240-v 50- to 63-cycle 3-wire 1-phase ac

MAJOR COMPONENTS

QTY	ITEM	STOCK NUMBERS	DIMENSIONS (Inches)	WEIGHT (Lbs)
1	Frequency Shift Keyer, Model XFK			
3	Mast AB-86/GRA-4	5985-244-5147		
2	Oscillator, Model PMO			
1	Radio Telephone Transmitting Equipment TDD-4			
2	Radio Transmitter, CR Model 32-BA-9			
1	Shelter with trailer mounting chassis			

REFERENCE DATA AND LITERATURE:

SHIPPING DATA

PKGS	VOLUME (Cu Ft)	WEIGHT (Lbs)
1	341.6	3,200 (approx.)

MIL-HDBK-161

AN/MRT-7 RADIO TRANSMITTING SET

PROCUREMENT DATA

PROCURING SERVICE: USAF
SPEC &/or DWG: RADC-2449

DESIGN COG: USAF, RCUE

CONTRACTOR	LOCATION	CONTRACT OR ORDER NO.	APPROX UNIT COST
------------	----------	--------------------------	---------------------

RADIO SET AN/MRT-type

1 July 1958

Cognizant Serv: USA FSN:

SCR-573-()

USA

USN

USAF

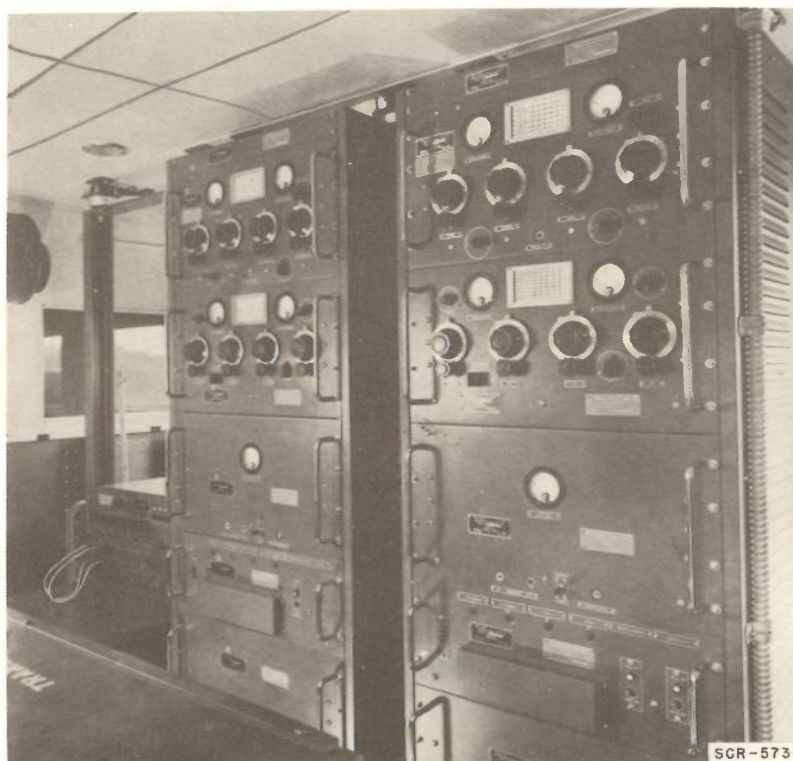
TYPE CLASS: L/Std
STOCK NO: 2S573--
--L/Std
--**FUNCTIONAL DESCRIPTION:**

Radio Set SCR-573-() is AM or tone-modulated, VHF, transmitting equipment for ground-to-air, and point-to-point communication. It is normally operated as mobile equipment from Truck K-53 and Trailer K-63, both of which are supplied. Radio Set SCR-573-A (transmitting station), when used with Radio Set SCR-574-A (receiving station), comprises a two-way, VHF Fighter Control Net System.

Two Radio Transmitters BC-640, each operating on one preset, crystal-controlled frequency, provide dual channel transmission.

This equipment can be controlled locally, or remotely over standard telephone lines from a distance of 60 to 120 miles. The distance between transmitters and receivers should be at least 1/4 mile because the transmitters may block out receivers operating in adjacent channels. Separation between trans-

mitting and receiving stations at the same terminal installation should not exceed 2 miles.

Recommended antenna system consists of Antenna AN-86 (76 feet), two Antenna Equipments RC-81, and associated coaxial cable.

Power is normally furnished by Power Unit PE-99 (part of Radio Set SCR-573), or an equivalent source.

TECHNICAL CHARACTERISTICS:

Frequency Range in Mc: 100 to 156

Type Modulation: AM

Type of Signal: Voice or tone

Power Output: 50 w per transmitter

Power Requirement: 2.5 kva 110v 50/60 cycle 1 phase ac (without heater); or 7.5 kvs 120v 50/60 cycle 3 phase ac (with heater)

MIL-HDBK-161

AN/MRT-type RADIO SET

MAJOR COMPONENTS

QTY	ITEM	STOCK NUMBERS	DIMENSIONS (Inches)	WEIGHT (Lbs)
(USA)				
2	Antenna Equipment RC-81-A	-----	12 x 28 x 38	4
1	Control Unit RM-27	-----	11-3/8 x 19 x 10-1/2	29
2	Radio Transmitter BC-640	2C530-640	72 x 21 x 20	515
1	Trailer K-63 (with Power Unit PE-99)	-----	72 x 72 x 144	2,860
1	Truck K-53	-----	130 x 96 x 256	13,385

REFERENCE DATA AND LITERATURE:

TM 11-866
TO AN-40SCR573-2

SHIPPING DATA

PKGS	VOLUME (Cu Ft)	WEIGHT (Lbs)
2	2,275	17,760

PROCUREMENT DATA

PROCURING SERVICE: USA
SPEC &/or DWG: USA 271-1336

DESIGN COG: USA, Sig C

CONTRACTOR	LOCATION	CONTRACT OR ORDER NO.	APPROX UNIT COST
------------	----------	--------------------------	---------------------

Bendix Radio Corp.
Sparks, Withington

RADIO TRANSMITTER AN/MRT-type

1 July 1958

Cognizant Serv: USA FSN: 5820-545-7268

T-208/U

USA

USN

USAF

TYPE CLASS:

Std

STOCK NO:

2C6900-208



FUNCTIONAL DESCRIPTION:

Radio Transmitter T-208/U is an FM radio transmitter designed for mobile use. It is intended for use in system applications to provide point-to-point communication, or radio relay service by retransmission.

This transmitter is used as a component of Radio Set AN/VRC-6().

Provision is made for operation on either of two preset crystal-controlled frequencies.

TECHNICAL CHARACTERISTICS:

Frequency Range in Mc: 25 to 50

Type Modulation: FM

Type of Signal: Voice

Power Output: 25 w

Power Requirements: Dynamotor DY-93/G (20 amp at 12-v dc), Dynamotor DY-98/G (10 amp at 24-v dc); or Dynamotor DY-100/U (40 amp at 6-v dc); none of these dynamotors are supplied with this equipment

MAJOR COMPONENTS

QTY	ITEM	STOCK NUMBERS	DIMENSIONS (Inches)	WEIGHT (Lbs)
		(FSN)		
1	Radio Transmitter T-208/U	5820-545-7268	8-1/2 x 4-1/2 x 14-1/2	
	(Equipment consists of only one major component; it relies on other system components for power and control functions.)			

REFERENCE DATA AND LITERATURE:

TM 11-804

MIL-HDBK-161

AN/MRT-type RADIO TRANSMITTER

SHIPPING DATA

PKGS	VOLUME (Cu Ft)	WEIGHT (Lbs)
1	varies	varies

PROCUREMENT DATA

PROCURING SERVICE: USA
SPEC &/or DWG: MIL-N-11539

DESIGN COG: USA, Sig C

CONTRACTOR	LOCATION	CONTRACT OR ORDER NO.	APPROX UNIT COST
Motorola, Inc.	Chicago, Ill.	11661-P-52-93	

COMMUNICATIONS CENTRAL OFFICE GROUP AN/MSA-1

25 November 1958

Cognizant Serv: USN FSN:

USA

USN

USAF

TYPE CLASS: --

Used by --

STOCK NO: --

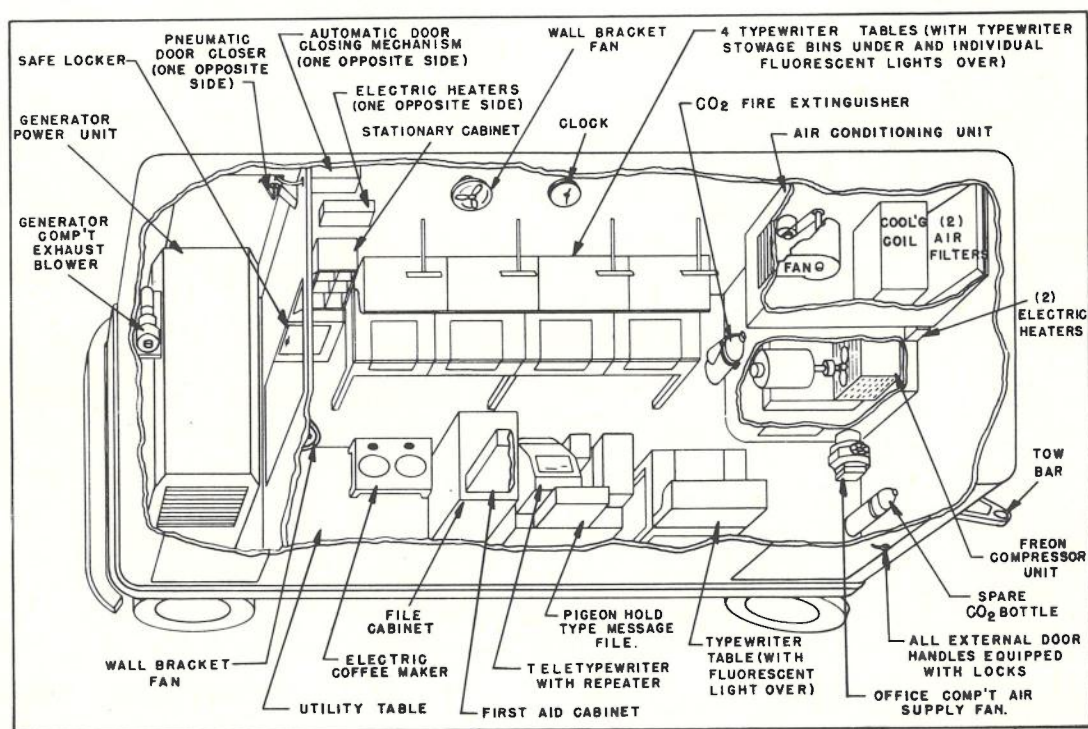

AN/MSA-1

FUNCTIONAL DESCRIPTION:

Communications Central Office Group AN/MSA-1 is a fully equipped trailer type van that provides facilities for performing cryptographic functions in a mobile communications center, such as Communications Central AN/MS-3.

This equipment includes built-in furniture, lighting, heating, air conditioning, and power generating units. Terminals are installed for two teletypewriter and six telephone circuits.

It is equipped with a carbon dioxide fire protection system. The power system is designed to furnish an independent

source of power for air conditioning, lighting, and miscellaneous office use. Provision is also made for receiving power from an external source and for furnishing power to an external load.

TECHNICAL CHARACTERISTICS:

Teletypewriter: Automatic reception from line circuits of associated units of a communications central

Power Supply Equipment: Power Unit PE-95-G; used when external power source is not available

Power Requirements: 10 kw 120-v 60-cycle 1- or 3-phase ac

MIL-HDBK-161

AN/MSA-1 COMMUNICATIONS CENTRAL OFFICE GROUP

MAJOR COMPONENTS

QTY	ITEM	STOCK NUMBERS	DIMENSIONS (Inches)	WEIGHT (Lbs)
2	Communication handset			
2	File cabinet			
1	Power Unit PE-95-G	-----	67-1/2 x 38-1/2 x 28-1/4	1,556
1	Safe Locker No. 6			
1	Teletypewriter Model 19	-----	34-3/8 x 41-5/8 x 23-1/2	
5	Typewriter			
1	Van	-----	129 x 95 x 245	17,000

REFERENCE DATA AND LITERATURE:

NAVSHIPS 91498

SHIPPING DATA

PKGS	VOLUME (Cu Ft)	WEIGHT (Lbs)
1	1,500	17,000

PROCUREMENT DATA

PROCURING SERVICE: USN
SPEC &/or DWG:

DESIGN COG: USN, BuShips

CONTRACTOR	LOCATION	CONTRACT OR ORDER NO.	APPROX UNIT COST
Boston Naval Shipyard	Boston, Mass.	44704, 45707, 80701	

CONTROL SWITCHBOARD **AN/MTC-type**

1 July 1958

Cognizant Serv: USA FSN: 6110-164-8067

SB-100/MTC

USA

USN

USAF

TYPE CLASS:

Std

--

Std

STOCK NO:

4C9905-100

--

--

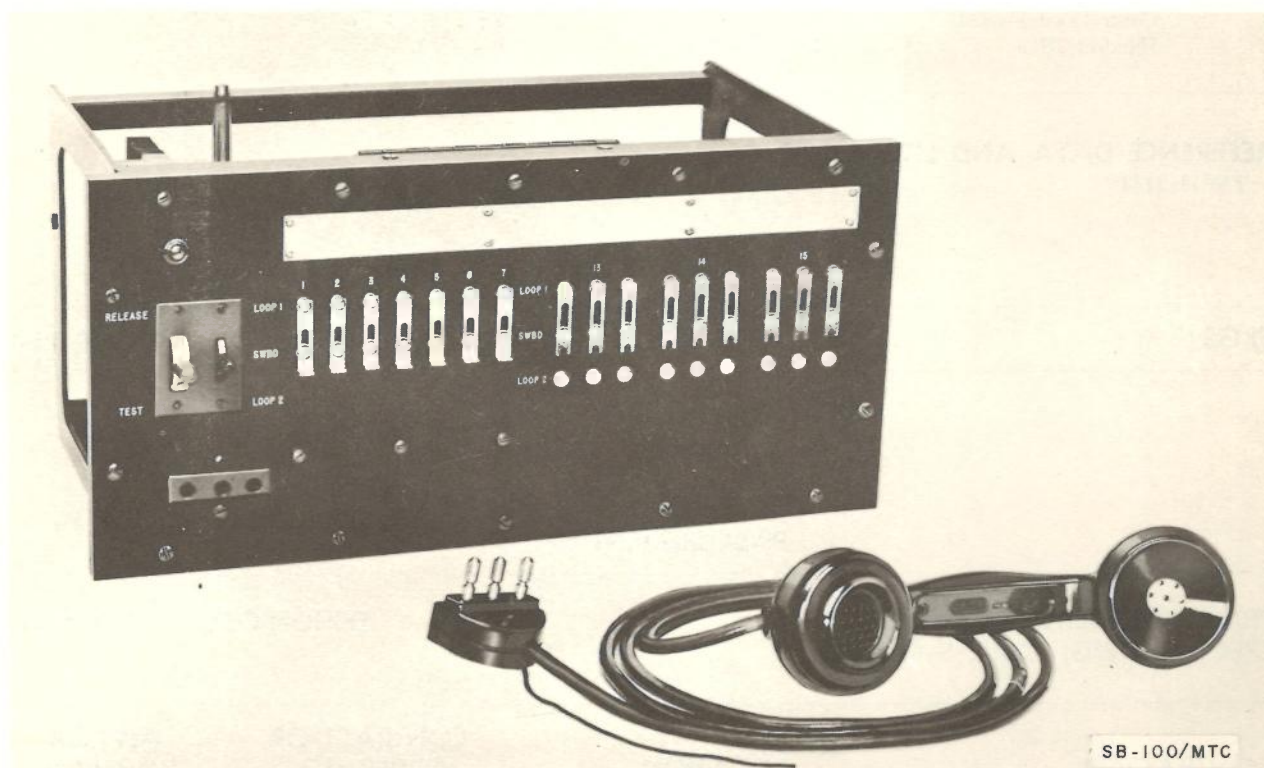

SB-100/MTC

FUNCTIONAL DESCRIPTION:

Control Switchboard SB-100/MTC is semiautomatic equipment used for quickly grouping field telephones of a network for alerts, conferences, and instructions. It is usually mounted atop the administrative switchboard.

This equipment, consisting of the switchboard component and a handset has no means for ringing and signaling.

TECHNICAL CHARACTERISTICS:

Number of Positions: 1

Number and Type of Circuits: 14 manually operated lines

Power Requirements: 3-v dc; 0.5 amp at 24-v dc

MIL-HDBK-161

AN/MTC-type CONTROL SWITCHBOARD

MAJOR COMPONENTS

QTY	ITEM	STOCK NUMBERS	DIMENSIONS (Inches)	WEIGHT (Lbs)
		(FSN)		
1	Control switchboard	-----	8 x 17 x 9-3/16	20
1	Handset TS-9	5965-170-6473	9 x 3 x 3	1.75

REFERENCE DATA AND LITERATURE:

TM 11-2133

SHIPPING DATA

PKGS	VOLUME (Cu Ft)	WEIGHT (Lbs)
1	3.20	57

PROCUREMENT DATA

PROCURING SERVICE: USA
SPEC &/or DWG: MIL-S-12662

DESIGN COG: USA, Sig C

CONTRACTOR	LOCATION	CONTRACT OR ORDER NO.	APPROX UNIT COST
General Development Corp.	Trenton, N. J.	15920-P-55-53	\$354.00
Great American Electric Co.	Meridan, Conn.	31164-P-55-53	198.00

OPERATIONS CENTER AN/MTQ-1()

1 July 1958

Cognizant Serv: USA FSN: 5895-537-7440

USA

USN

USAF

TYPE CLASS:

Std

STOCK NO:

4C5970-1

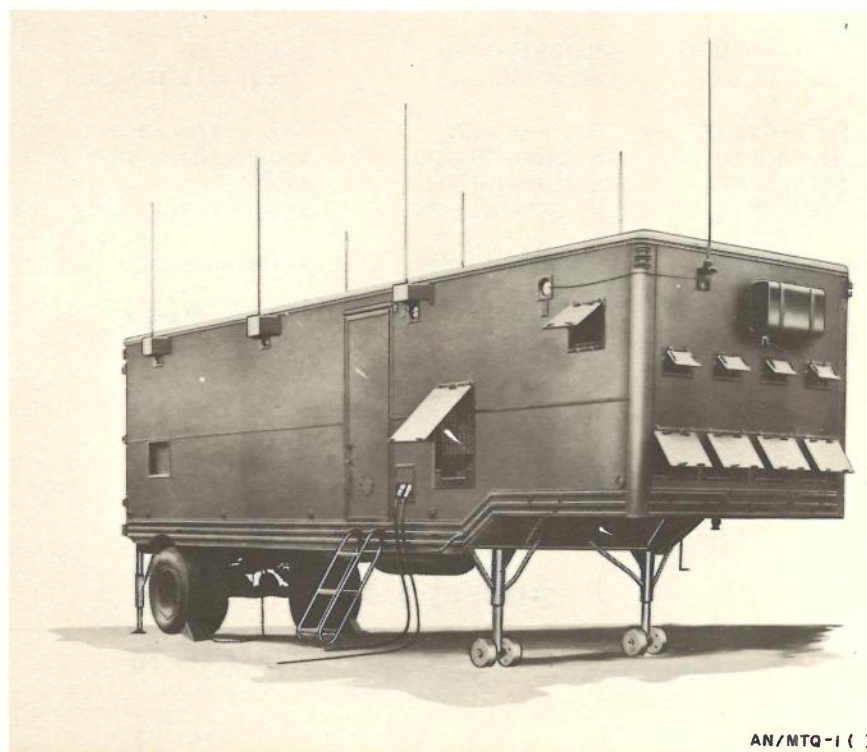

AN/MTQ-1()

FUNCTIONAL DESCRIPTION:

Operations Center AN/MTQ-1() is a mobile operations center used as the tactical or battle headquarters of an anti-aircraft defense command to collect, evaluate, and disseminate intelligence, and to direct firing when necessary.

This equipment, consisting of three trailers (an equipment trailer and two power trailers), is not designed to operate on the move.

The equipment van contains telephone, teletypewriter, radar repeater, and radio equipment, display boards, air conditioning equipment, and accessory items. Communication equipment is not supplied but facilities for mounting such equipment are provided.

The AN/MTQ-1, AN/MTQ-1A, and AN/MTQ-1B are functionally identical. Each operations center normally requires 220-volt, 3-wire, 1-phase ac power, but can be operated on 110 volts if the air conditioning equipment is not connected. Power is normally supplied by a trailer-mounted Power Unit PE-95-() but commercial power may be substituted, if available.

TECHNICAL CHARACTERISTICS:

Power Requirements: 10 kw 220-v 60-cycle 3-wire 1-phase ac;
or 4 kw 110-v 60-cycle 2-wire 1-phase ac without air conditioning equipment

AN/MTQ-1() OPERATIONS CENTER

MAJOR COMPONENTS

QTY	ITEM	STOCK NUMBERS	DIMENSIONS (Inches)	WEIGHT (Lbs)
1	Azimuth Indicator VK-4	(USA)2C1582-35		378
3	Control Unit C-199/TTQ	(FSN)5820-170-4782	6-7/16 x 4-7/16 x 5-1/4	5.5
1	Power Supply PP-327/ GRC-9Y	(USA)3H4497-327	15-1/4 x 20-5/8 x 8-1/2	85
1	Power Supply PP-989/MTQ-1	(USA)3H4497-989	24 x 12 x 48	270
1	Range-Azimuth Indicator AN/SPA-4	(USA)2C1559A-4	18 x 21-3/4 x 37-13/16	315
1	Relay Test Set TS-772/GT	(USA)3F4325-772	6-1/2 x 11/16 x 1	1
1	Relay Unit RE-8A/TTQ	(FSN)5830-170-3616	19-3/4 x 8-1/2 x 5-1/2	24
1	Relay Unit RE-24C/TTQ	(FSN)5805-194-8137	48 x 24 x 12	210
1	Switchboard Table FN-61/ MTQ-1	(FSN)5805-392-8664	24-1/4 x 15-1/4 x 29-1/2	23.5
2	Trailer-Mounted Gasoline Engine	(FSN)6115-356-0995	97 x 83 x 165-1/2	4,500
1	Van Semitrailer V-79/G	(USA)6J1101-79	135 x 95-1/2 x 363	10,500
1	Video Amplifier AM-549/ MTQ-1	(USA)2C333-6	8-1/4 x 7-1/2 x 5-1/2	12

REFERENCE DATA AND LITERATURE:

TM 11-5550

SHIPPING DATA

PKGS	VOLUME (Cu Ft)	WEIGHT (Lbs)
------	----------------	--------------

PROCUREMENT DATA

PROCURING SERVICE: USA
SPEC &/or DWG: MIL-O-10605

DESIGN COG: USA, Sig C

CONTRACTOR	LOCATION	CONTRACT OR ORDER NO.	APPROX UNIT COST
Wickes Engr. & Construction Co.	Camden, N. J.	6433-P-51-31	\$65,877.00

TELETYPEWRITER SET AN/PGC-1

1 July 1958

Cognizant Serv: USA FSN: 5815-198-5963

	USA	USN	USAF
TYPE CLASS:	Std	--	Std
STOCK NO:	4T2-19	--	1730-480008098

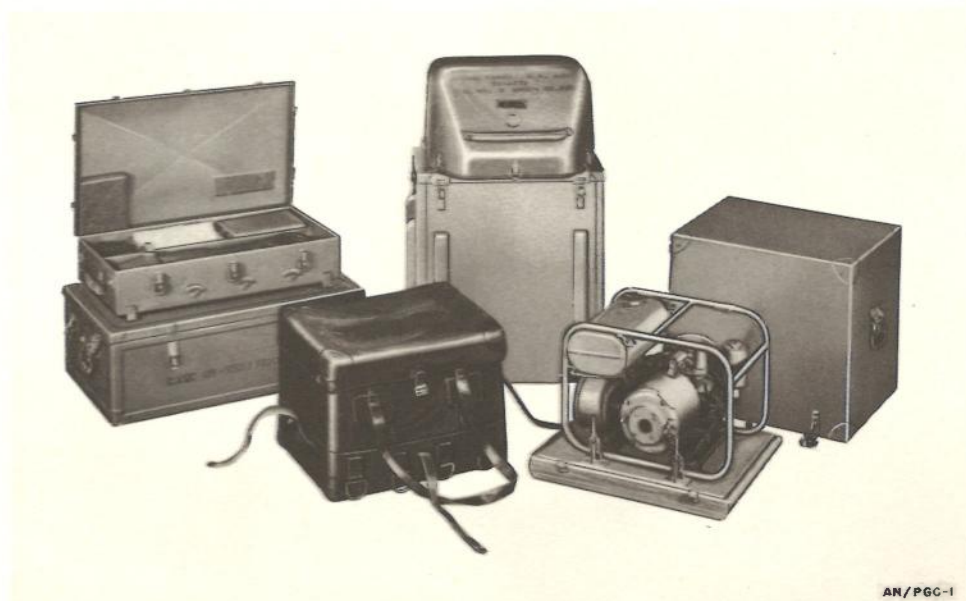

AN/PGC-1

FUNCTIONAL DESCRIPTION:

Teletypewriter Set AN/PGC-1 is a portable, field teletypewriter station.

This equipment consists of a lightweight teletypewriter, a gasoline-engine-driven electrical generator, carrying cases, and accessories. The cases are used to mount the equipment during operation in the field. The entire equipment can be transported on packboards.

This set is designed to operate in neutral circuits but can be adapted to receive and transmit polar signals. It is usually connected to the remote teletypewriter through a dc telegraph line, tactical carrier facilities, or a radio channel. It can be arranged for half-duplex, full-duplex, or sending- or receiving-

only operation. Two or more of these sets can be interconnected for operation with each other without using intermediate line modifying equipment.

TECHNICAL CHARACTERISTICS:

Operating Functions: Keyboard operation; remote motor stop and break-in facilities; no weather keyboard available

Operating Speed: 368.1 opm (60 wpm); gears furnished for 600 opm (100 wpm); 72 characters per line

Motor Characteristics: Universal (ac or dc) series type, tuning fork speed adjusting frequency 3,600 rpm

Power Requirements: 150 w 105/125-v dc or 105/125-v 50/60-cycle ac

MIL-HDBK-161

AN/PGC-1 TELETYPEWRITER SET

MAJOR COMPONENTS

QTY	ITEM	STOCK NUMBERS	DIMENSIONS (Inches)	WEIGHT (Lbs)
		(FSN)		
1	Bag CW-160/PGC-1	5851-498-9111	20 x 10 x 3	
1	Case CY-552/PGC-1	-----	27 x 16 x 6	24
1	Case CY-553/PGC-1	-----	30-1/2 x 19-1/2 x 9-1/2	30
1	Engine-Generator PU-181/ PGC-1	6115-242-2297	17-1/2 x 12-3/4 x 14-3/4	95
1	Teletypewriter TT-4/TG	5815-198-4438	24-3/8 x 20-7/8 x 16-3/8	94.5

REFERENCE DATA AND LITERATURE:

TM 11-2235

SHIPPING DATA

PKGS	VOLUME (Cu Ft)	WEIGHT (Lbs)
3	19.5	285

PROCUREMENT DATA

PROCURING SERVICE: USA
SPEC &/or DWG: (USA) 71-3364

DESIGN COG: USA, Sig C

CONTRACTOR	LOCATION	CONTRACT OR ORDER NO.	APPROX UNIT COST
National Cash Register Co.	Dayton, Ohio	6611-P-51-09	

TELEGRAPH SET AN/PGC-type

26 November 1958

Cognizant Serv: USA FSN: 5805-407-3616

TG-5-B

USA

USN

USAF

TYPE CLASS: --
STOCK NO: --

Used by --
--

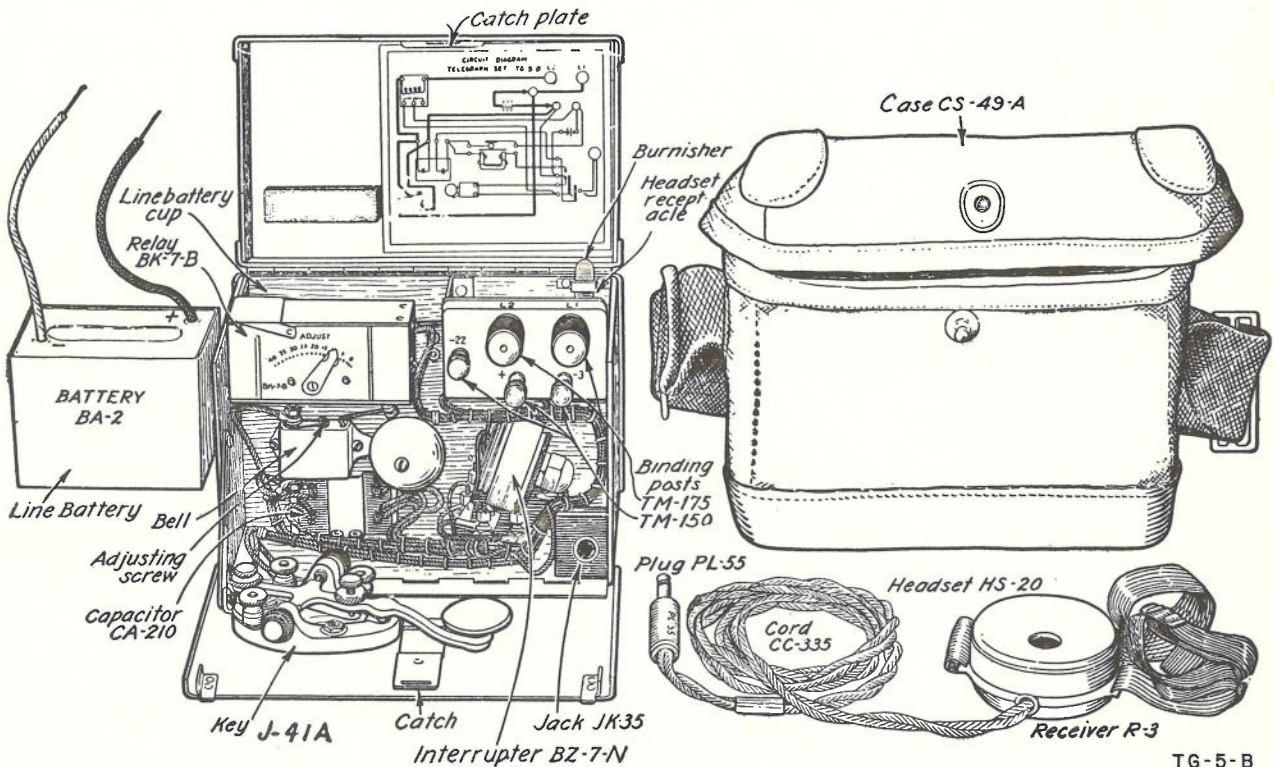

FUNCTIONAL DESCRIPTION:

Telegraph Set TG-5-B is a portable, open-circuit field telegraph set designed for telegraph communication over short lines. Telegraph sets may be connected directly to each other by metallic ground or ground-return circuits, or they may be used in conjunction with existing wire systems to provide additional communication channels. The unit also can be used as a tone keyer for voice-modulated radio sets. The range of the equipment varies with the type of line used, the condition of the wire, whether the wire is wet or dry, and whether the wire is on the ground or in the air.

When used on metallic or ground-return lines, two telegraph sets may be connected in series as terminal stations, and one or more telegraph sets connected in series with them as intermediate stations. No more than three or four telegraph sets, however, can be so connected and still operate with each other.

When used in conjunction with existing wire systems, two

telegraph sets may be connected in series as terminal stations, or one or more connected in series with them as intermediate stations. Operation may be simplex, phantom, or simplex-phantom circuits, with connections made through repeating coils in the equipment with which they are operated.

The equipment will operate satisfactorily as a tone keyer with any radio set using a carbon button microphone. An adapter cord is necessary to permit use of the telegraph set as a tone keyer.

All circuit elements of the TG-5-B are contained in a sheet-metal box. The set is provided with a canvas carrying case.

TECHNICAL CHARACTERISTICS:

- Operating Speed-, Two Sets Working Together:
 - 50 Miles Wet Wire W-110-B: 20 wpm
 - Dry Wire W-110-B: Will operate satisfactorily when total resistance of line does not exceed 23,600 ohms
- Power Requirements: 12-v dc 3-v dc or 22-1/2-v dc

AN/PGC-type TELEGRAPH SET

MAJOR COMPONENTS

QTY	ITEM	STOCK NUMBERS	DIMENSIONS (Inches)	WEIGHT (Lbs)
		(USA)		
1	Telegraph Set TG-5-B, consisting of:	-----	5-1/2 x 5-1/2 x 10	
1	Case CS-49-A with shoulder strap	4A349A		
1	Headset HS-20	2B832		
1	Interrupter BZ-7-N	4Z5007		
1	Jack JK-35	2Z5535		
1	Key J-41-A	3Z441A		
1	Relay BK-7-B	4A2007B		
1	Terminal block assembly	2Z9405.22		

REFERENCE DATA AND LITERATURE:

SHIPPING DATA

PKGS	VOLUME (Cu Ft)	WEIGHT (Lbs)

PROCUREMENT DATA

PROCURING SERVICE: USA
SPEC &/or DWG:

DESIGN COG: USA, Sig C

CONTRACTOR	LOCATION	CONTRACT OR ORDER NO.	APPROX UNIT COST

PUBLIC ADDRESS SET **AN/PIP-1A**

25 November 1958

Cognizant Serv: USN FSN: 5830-644-4413

USA

USN

USAF

TYPE CLASS: --
STOCK NO: --

Used by --

FUNCTIONAL DESCRIPTION:

Public Address Set AN/PIP-1A is a compact and portable instrument which may be used in the same way as an ordinary megaphone. The set is designed for intermittent operation. It amplifies and transmits intelligible speech over extended distances through high ambient noise levels.

A total operating cycle of 2 hours at 50 percent on and 50 percent off is available from the fully charged battery. However, continuous operation for more than 10 minutes may overheat and thus damage the vibrator power supply. Each operating period should be followed by an equal deenergizing period.

This equipment is directly interchangeable, electrically and mechanically, with Public Address Set AN/PIP-1.

TECHNICAL CHARACTERISTICS:*Loudspeaker-microphone:*

Type: A pressure-operated magnetic controlled reluctance microphone element

Impedance: 1,600 ohms

Remote Microphone:

Type: A pressure-operated magnetic controlled reluctance microphone element

Impedance: 1,600 ohms

Audio Amplifier:

Frequency Response: 400 cps to 5,500 cps

Stages: 3, push-pull

Output: 10 w

Loudspeaker: A driver mechanism coupled to a horn

Power Requirements: 6 v (Battery BB-207/U)

**MAJOR COMPONENTS**

QTY	ITEM	STOCK NUMBERS	DIMENSIONS (Inches)	WEIGHT (Lbs)
1	Audio-Frequency Amplifier AM-568A/PIP-1	-----	6-1/2 x 10-1/2 x 12	20
1	Loudspeaker-Microphone LS-183A/PIP-1	-----	6 x 13-1/2 x 13-3/4	5.25
1	Maintenance Parts Kit MK-132/PIP-1A	-----	6 x 12 x 18	32
1	Remote Microphone TH-4	-----	1-11/16 x 2-5/8 x 4-15/16	2

MIL-HDBK-161

AN/PIP-1A PUBLIC ADDRESS SET

REFERENCE DATA AND LITERATURE:
NAVSHIPS 365-2035

SHIPPING DATA

PKGS	VOLUME (Cu Ft)	WEIGHT (Lbs)
------	----------------	--------------

PROCUREMENT DATA

PROCURING SERVICE: USN
SPEC &/or DWG:

DESIGN COG: USN, BuShips

CONTRACTOR	LOCATION	CONTRACT OR ORDER NO.	APPROX UNIT COST
Audio Equipment Co., Inc.	Great Neck, N. Y.	NObsr-59427	

PUBLIC ADDRESS SET **AN/PIQ-1**

25 November 1958

Cognizant Serv: USA FSN: 5830-164-6620

	USA	USN	USAF
TYPE CLASS:	Std	--	Std
STOCK NO:	6C198-1	--	--

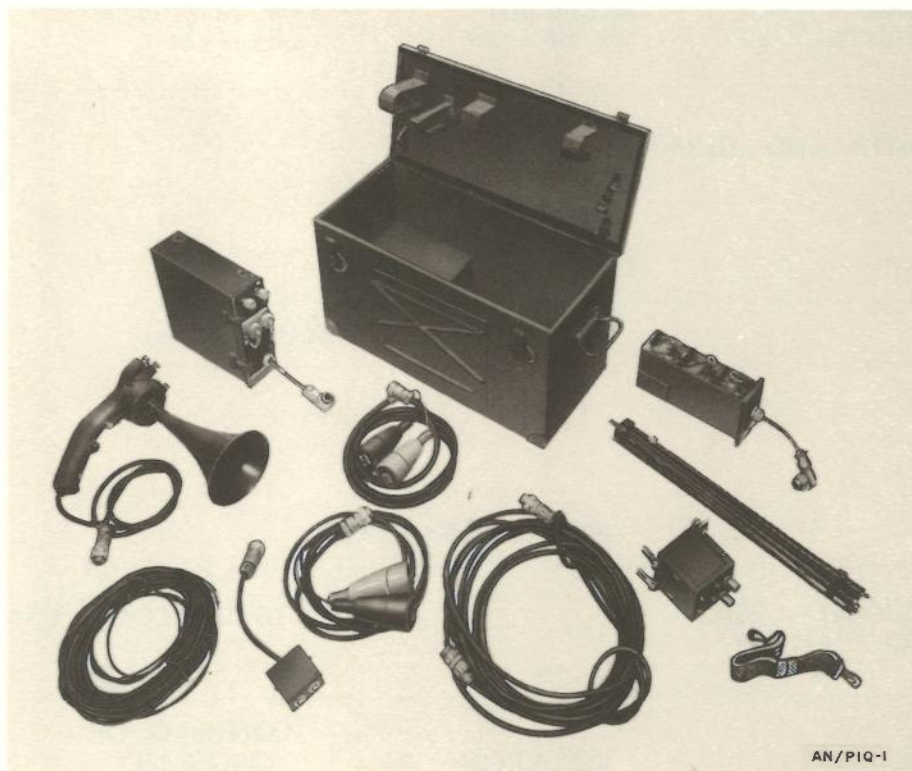
**FUNCTIONAL DESCRIPTION:**

Public Address Set AN/PIQ-1 is a portable (man-carried), low-power, short-range, voice amplifying and projecting equipment used by tactical or training units to control or brief groups of personnel within 200 yards of the set.

This equipment can be arranged for operation with the loudspeaker mounted on a handle supporting a lip microphone or it may be mounted on a tripod for stationary use. By means of auxiliary equipment, this set can be modified to allow the operator's hand to remain free while using the equipment.

The set can be installed and operated in a vehicle and con-

nected to a larger loudspeaker; also it can be operated by a direct current power supply.

Earlier models are designed to hold three rechargeable wet cells in the battery tray; later models can accommodate either wet or dry cell batteries.

TECHNICAL CHARACTERISTICS:

Facilities: Single-channel public address; voice

Type Controls: Volume; push-to-talk switch

Power Output: 1-1/2 w

Power Requirements: 3 Batteries BB-206/U (storage) or 3

Batteries BA-56 and 4 Batteries BA-41 (in emergency, Battery BA-30 may be substituted for Battery BA-41)

MIL-HDBK-161

AN/PIQ-1 PUBLIC ADDRESS SET

MAJOR COMPONENTS

QTY	ITEM	STOCK NUMBERS	DIMENSIONS (Inches)	WEIGHT (Lbs)
1	Amplifier AM-74/PIQ-1	5830-164-7289	2-1/4 x 8-1/4 x 4	3.4
1	Loudspeaker LS-110/PIQ-1	5965-160-2463	5 x 10-3/4	1.75
1	Microphone M-8/PIQ-1	5965-194-9774	3-1/8 x 3-1/2 x 10-1/4	.90
1	Tripod MT-353/PIQ-1	5965-160-4744	1-5/8 x 18 x 58	2.25

REFERENCE DATA AND LITERATURE:

TM 11-2566

SHIPPING DATA

PKGS	VOLUME (Cu Ft)	WEIGHT (Lbs)
1	2.58	70

PROCUREMENT DATA

PROCURING SERVICE: USA
SPEC &/or DWG: 17-3163

DESIGN COG: USA, Sig C (RCUE)

CONTRACTOR	LOCATION	CONTRACT OR ORDER NO.	APPROX UNIT COST
------------	----------	--------------------------	---------------------

PUBLIC ADDRESS SET **AN/PIQ-2**

25 November 1958

Cognizant Serv: USA FSN: 5830-164-7332

	USA	USN	USAF
TYPE CLASS:	L/Std	--	Std
STOCK NO:	6C260-146S	--	1790-612859950

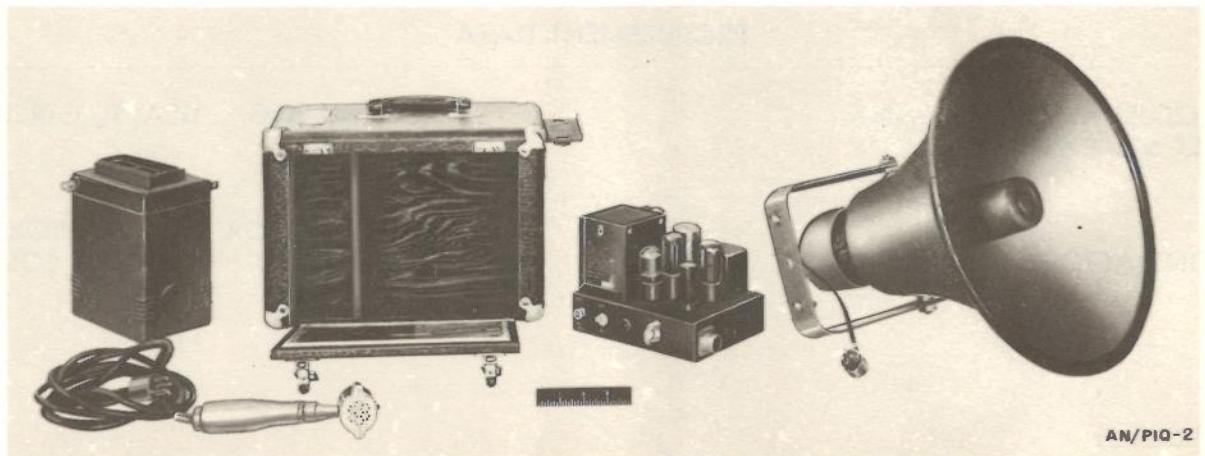
**FUNCTIONAL DESCRIPTION:**

Public Address Set AN/PIQ-2 is a portable, medium-power, general-purpose sound amplification and projection equipment used for beach control purposes during amphibious operations. It also may be used to control personnel in similar tactical operations.

The operating range of this equipment is approximately 300 to 400 yards.

Primarily, this set is designed for use where 110-volt alter-

nating current power is not available. For power, a 6-volt storage battery is included in a specially designed container.

TECHNICAL CHARACTERISTICS:

Facilities: Single-channel public address; voice

Type Controls: On-off switch; volume control

Power Output: 10 to 14 w

Power Requirements: 6-v dc

MAJOR COMPONENTS

QTY	ITEM	STOCK NUMBERS	DIMENSIONS (Inches)	WEIGHT (Lbs)
1	Audio amplifier			
1	Hand microphone			
1	Loudspeaker			

REFERENCE DATA AND LITERATURE:

AN/PIQ-2 PUBLIC ADDRESS SET

SHIPPING DATA

PKGS	VOLUME (Cu Ft)	WEIGHT (Lbs)
1	----	87

PROCUREMENT DATA

PROCURING SERVICE: USA
SPEC &/or DWG:

DESIGN COG: USA, Sig C (RCUE)

CONTRACTOR	LOCATION	CONTRACT OR ORDER NO.	APPROX UNIT COST
------------	----------	-----------------------	------------------

SOUND REPRODUCING EQUIPMENT **AN/PNH-type**

5 December 1958

Cognizant Serv: USN FSN:

PG

	USA	USN	USAF
TYPE CLASS:	--	Used by	--
STOCK NO:	--	--	--

**FUNCTIONAL DESCRIPTION:**

Sound Reproducing Equipment PG is a portable sound reproducing equipment designed to reproduce the audio signals embossed on Memodiscs by Voice Recording Equipments PE and PE-1.

The equipment contains a foot-operated control that permits the operator to start and stop reproduction as desired, and to cause the repetition of as much of the material just reproduced as may be desired.

TECHNICAL CHARACTERISTICS:

Frequency Range: 200 to 3000 cps

Output Impedance: 600 ohms

Turn Table Size: 16-1/4 in. dia.

Rotation: Clockwise or counterclockwise

Power Requirements: 110 w, 110/120-v 58/62-cycle 1-phase ac

PG

MIL-HDBK-161

AN/PNH-type SOUND REPRODUCING EQUIPMENT

MAJOR COMPONENTS

QTY	ITEM	STOCK NUMBERS	DIMENSIONS (Inches)	WEIGHT (Lbs)
1	Sound Reproducing Equip- ment PG (Equipment consists of only one major component.)	-----	13-3/4 x 22 x 24-1/2	100

REFERENCE DATA AND LITERATURE:

NAVSHIPS 95207

SHIPPING DATA

PKGS	VOLUME (Cu Ft)	WEIGHT (Lbs)
------	----------------	--------------

PROCUREMENT DATA

PROCURING SERVICE: USN
SPEC &/or DWG:

DESIGN COG: USN, BuShips

CONTRACTOR	LOCATION	CONTRACT OR ORDER NO.	APPROX UNIT COST
Memovox, Inc.	Beverly Hills, Calif.	NXss-15073	

SOUND RECORDER-REPRODUCER **AN/PNH-type**

20 November 1958

Cognizant Serv: USA FSN: 5835-170-4850

RD-31A/U

	USA	USN	USAF
TYPE CLASS:	Std	Used by	Std
STOCK NO:	6C272-7	--	--

(No Illustration Available)

FUNCTIONAL DESCRIPTION:

Sound Recorder-Reproducer RD-31A/U is a self-contained, portable, magnetic steel wire recorder and reproducer which records speech or music from a microphone, telephone, or program line source. Recordings may be played back immediately through this equipment's self-contained loudspeaker or through an external loudspeaker or headset. The equipment can be used as a public address set to cover a limited area with the self-contained speaker or to cover a large area with an external speaker (not supplied with equipment).

TECHNICAL CHARACTERISTICS:*Frequency Response:* 150 to 5,000 cps at ± 3 db*Power Output:* 5 watts*Recording-Reproducing Medium:* Stainless steel wire*Recording Time:* 60 minutes maximum*Wire Speed:* 2-1/2 feet per second*Wire Size:* 0.004 inch diameter*Recorder-Reproducer Head:*

Type: Magnetic

Impedance: 800 ohms at 1 kc; 890 ohms erase-coil impedance at 40 kc

Loudspeaker:

Type: Permanent magnet

Cone Dia.: 5 inch

Output Transformer Impedance: Primary, 5,000 ohms; secondary, 3.5 ohms*Microphone:*

Type: Dynamic

Impedance: 30,000 ohms

Motor:

Horsepower: 1/100

Rotation: 1,600 rpm

Power Requirements: 100 w 105/120-v 60-cycle ac**MAJOR COMPONENTS**

QTY	ITEM	STOCK NUMBERS	DIMENSIONS (Inches)	WEIGHT (Lbs)
1	Microphone			
1	Sound Recorder-Reproducer, RD-31A/U	(USA) 6C272-7 (FSN) 5835-170-4850	10-3/8 x 12-13/16 x 13-3/4	32

REFERENCE DATA AND LITERATURE:

TM 11-2548

SHIPPING DATA

PKGS	VOLUME (Cu Ft)	WEIGHT (Lbs)
1	1.9	78

MIL-HDBK-161

AN/PNH-type SOUND RECORDER-REPRODUCER

PROCUREMENT DATA

PROCURING SERVICE: USA
SPEC &/or DWG: (USA) 71-33477

DESIGN COG: USA, Sig C

CONTRACTOR	LOCATION	CONTRACT OR ORDER NO.	APPROX UNIT COST
General Electric Co.			

SOUND RECORDER-REPRODUCER **AN/PNH-type**

20 November 1958

Cognizant Serv: USN FSN:

RD-115/UN, -115A/UN, -115C/UN

USA

USN

USAF

TYPE CLASS: --

Used by

Obs

STOCK NO: --

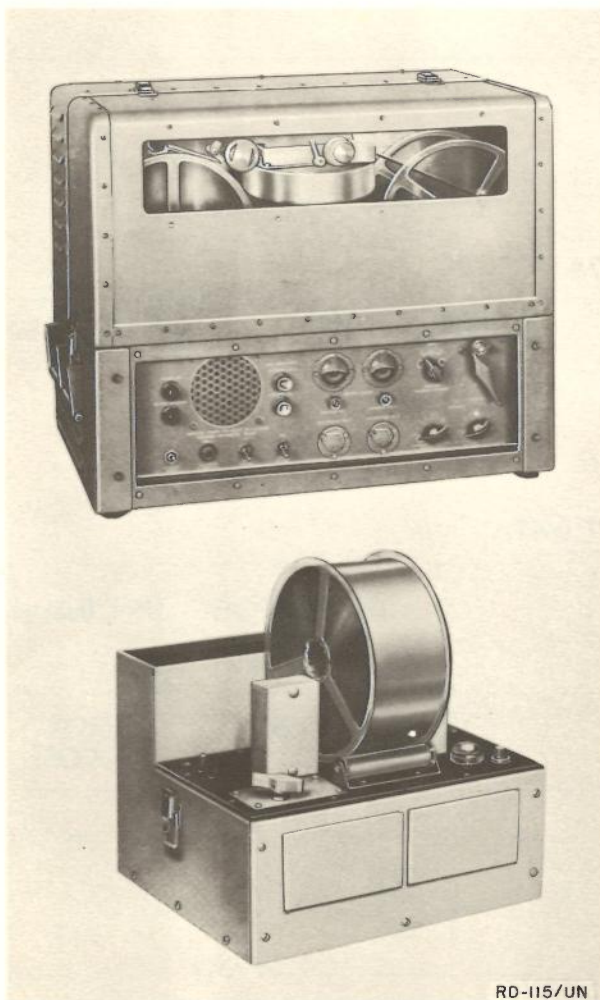

RD-115/UN

FUNCTIONAL DESCRIPTION:

Sound Recorder-Reproducers RD-115/UN, RD-115A/UN, and RD-115C/UN are portable 24-hour dual channel magnetic tape recorder-reproducers designed to record and play back audio signals. They are designed primarily for continuous recording applications, such as recording ship-to-shore and plane-to-control-tower conversations.

These equipments are interchangeable. The only difference between models is in minor component parts.

The units are designed for either rack or case mounting and contain warning lamp and buzzer signals which give warning when the tape needs replenishing.

TECHNICAL CHARACTERISTICS:

Type Recorder-Reproducer: Electromagnetic

Frequency Response: $\pm 1\frac{1}{2}$ db from 400 to 3,800 cps

Recording Medium: Red oxide coated paper tape, 3 inches wide by 1,136 feet long

Recording Time: 24-1/4 hours maximum continuous

Speed: 9.28 in. per minute

Amplifier Output: 2 w

Power Requirements: 125 w 115-v 60-cycle 1-phase ac

MIL-HDBK-161

AN/PNH-type SOUND RECORDER-REPRODUCER

MAJOR COMPONENTS

QTY	ITEM	STOCK NUMBERS	DIMENSIONS (Inches)	WEIGHT (Lbs)
1	Demagnetizer MX-1373/UN	-----	9 x 10-7/16 x 13	34
1	Recorder-Reproducer RD-115/UN	-----	12-1/2 x 17-3/16 x 21	67-1/2

REFERENCE DATA AND LITERATURE:

NAVSHIPS 365-1978 (RD-115/UN)
NAVSHIPS 365-3063 (RD-115A/UN, -115C/UN)

SHIPPING DATA

PKGS	VOLUME (Cu Ft)	WEIGHT (Lbs)
5	12.3	208-3/8

PROCUREMENT DATA

PROCURING SERVICE: USN
SPEC &/or DWG: MIL-R-17054

DESIGN COG: USN, BuShips

CONTRACTOR	LOCATION	CONTRACT OR ORDER NO.	APPROX UNIT COST
American Measuring Instruments Corp. Soundscriber Corp.	New York, N. Y. New Haven, Conn.	NObsr-66527 NObsr-54469 and NObsr-59493	\$865.00

SOUND RECORDER-REPRODUCER **AN/PNH-type**

20 November 1958

Cognizant Serv: USN FSN:

RD-133/UN

USA

USN

USAF

TYPE CLASS:
STOCK NO:--
--Used by

--

RD-133/UN

FUNCTIONAL DESCRIPTION:

Sound Recorder-Reproducer RD-133/UN is a self-contained portable sound recorder-reproducer. It consists of a single-speed tape transport mechanism, a record-produce-erase head, a 6-inch permanent magnet speaker, and an amplifier, all mounted in a fabric covered plywood carrying case.

This equipment is designed to record sound on a thin plastic material coated with iron oxide. Provision is made for monitoring the signal. The recording can be reproduced immediately with no further processing.

Sound recordings can be made from microphone, telephone lines, phonograph, or radio with either intermittent or continuous operation.

The equipment erases old recordings automatically as a new recording is made or it can erase without impressing any new signal on the tape. It can reproduce the recorded sound repeatedly in part or in its entirety.

TECHNICAL CHARACTERISTICS:

Type: Electromagnetic

Frequency Response: 8 db from 100 to 5,000 cps

Recording Medium: Plastic tape 1/4 in. wide coated with iron oxide.

Tape Speed: 3.75 in. per second

Amplifier Output: 2.5 w

Input Impedance:

Radio or Phonograph: 20,000 ohms

Microphone: 500,000 ohms

Output Impedance:

Monitor: 3.2 ohms

External Speaker: 3.2 ohms

Input Voltage Limits:

Radio or Phonograph: 2-v maximum

Microphone: 2-v maximum

Output Level: 2.5 w

Power Requirements: 106 w 115-v 60-cycle 1-phase ac

SPEAK-O-PHONE SOUND DETECTOR **AN/PNS-type**

20 November 1958

Cognizant Serv: FSN:

SDB

	USA	USN	USAF
TYPE CLASS:	--	Used by	--
STOCK NO:	--	--	--

(No Illustration Available)

FUNCTIONAL DESCRIPTION:

Speak-O-Phone Sound Detector Model SDB is a portable, battery-operated, three-stage, audio amplifier. It enables the operator to listen to conversations without the knowledge of those speaking when it is possible to "plant" a microphone in the room, when a wall or panel of an adjoining room is available, by direct connection to a telephone line, or by use of

induction coil tapping of a telephone line. Output signals are delivered to two separate phone jacks and to a special output jack for use with the crystal cutter of an accessory recorder. The recorder is not part of this equipment.

TECHNICAL CHARACTERISTICS:

Power Requirements: 1.5-v dc, 4.5-v dc, and 90-v dc from dry batteries

MAJOR COMPONENTS

QTY	ITEM	STOCK NUMBERS	DIMENSIONS (Inches)	WEIGHT (Lbs)
1	Amplifier unit w/control panel	-----	5-1/2 x 6 x 10-1/2	4.75
2	Carbon microphone	-----	3/4 high x 2-1/4 dia	0.365
1	Carrying case	-----	8-1/4 x 11-1/2 x 14-1/2	5.75
1	Contact microphone w/cable and connector	-----	5/8 x 2 x 144	0.375
2	Headphone w/headband	-----	1/4 x 2 x 10	1.00
1	Telephone induction coil w/ cable and connector	-----	7/8 x 3-1/8 x 144	0.438
2 reels	Telephone wire	-----	600 long	1.25

REFERENCE DATA AND LITERATURE:

TM 11-2541

SHIPPING DATA

PKGS	VOLUME (Cu Ft)	WEIGHT (Lbs)

MIL-HDBK-161

AN/PNS-type SPEAK-O-PHONE SOUND DETECTOR

PROCUREMENT DATA

PROCURING SERVICE:
SPEC &/or DWG:

DESIGN COG: Commercial

CONTRACTOR	LOCATION	CONTRACT OR ORDER NO.	APPROX UNIT COST
Speak-O-Phone	New York, N. Y.		

RADIO SET AN/PRC-1()

1 July 1958

Cognizant Serv: USA FSN:

USA

USN

USAF

TYPE CLASS:

Std

STOCK NO:

2S3503-1

--

--

--

--

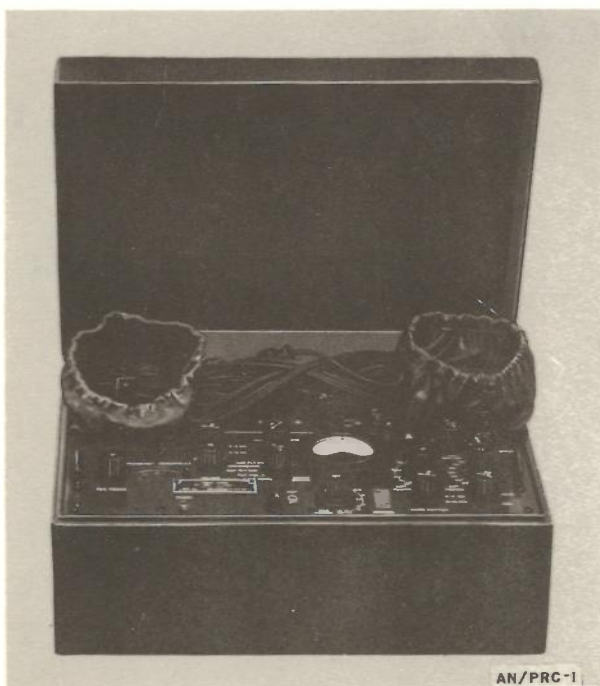
**FUNCTIONAL DESCRIPTION:**

Radio Set AN/PRC-1() is a complete portable radio receiving and transmitting equipment, used by special forces.

It consists essentially of a receiver-transmitter and a rectifier power unit, both contained in one housing.

TECHNICAL CHARACTERISTICS:

Frequency Range in Mc: 2 to 12 in two bands

Type Modulation: AM

Type of Signal: Receivers voice, tone, cw; transmits only cw

Power Output: 30 w

Power Requirements: 115/150/200/220/250-v 50/60-cycle ac

MAJOR COMPONENTS

QTY	ITEM	STOCK NUMBERS	DIMENSIONS (Inches)	WEIGHT (Lbs)
		(USA)		
1	Receiver-Transmitter RT-30/ PRC-1	2C5130-30.3	18 x 5-1/2 x 12	
1	Rectifier Power Unit PP-36/ PRC-1	3H4698-36		

REFERENCE DATA AND LITERATURE:

TM 11-638

MIL-HDBK-161

AN/PRC-1() RADIO SET

SHIPPING DATA

PKGS	VOLUME (Cu Ft)	WEIGHT (Lbs)
1	2.57	76

PROCUREMENT DATA

PROCURING SERVICE: USA
SPEC &/or DWG: (USA) 271-3035

DESIGN COG: USA, Sig C

CONTRACTOR	LOCATION	CONTRACT OR ORDER NO.	APPROX UNIT COST
		2260-P-44-08	

RADIO SET AN/PRC-5

1 July 1958

Cognizant Serv: USA FSN: 5820-404-5995

USA

USN

USAF

TYPE CLASS: S/Std
 STOCK NO: 2S3503-5

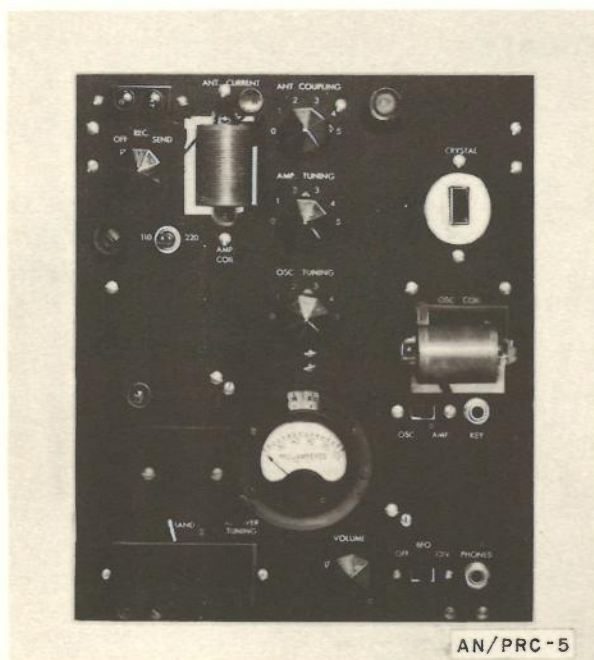

FUNCTIONAL DESCRIPTION:

Radio Set AN/TRC-5 is a portable cw receiving and transmitting equipment, mounted in a luggage-type carrying case, used for shortwave communication over medium distances by special forces.

It consists of a transceiver composed of a radiotelegraph receiver and transmitter unit with power supply and includes a telegraph key, headset, and auxiliary items.

TECHNICAL CHARACTERISTICS:

Frequency Range in Mc:

Transmitter: 4 to 16 in four bands

Receiver: 4.5 to 16 in two bands

Type Modulation: None*Type of Signal:* Cw*Transmitter Power Output:* 10 to 16 w*Power Requirements:* 110/220-v 50/60-cycle 1-phase ac

MAJOR COMPONENTS

QTY	ITEM	STOCK NUMBERS	DIMENSIONS (Inches)	WEIGHT (Lbs)
		(USA)		
1	Portable case, luggage type	2Z1800.4	12-1/4 x 10-3/4 x 8-1/2	
1	Radio receiver and transmitter	-----	11 x 10 x 4-1/8	15

REFERENCE DATA AND LITERATURE:

TM 11-265

MIL-HDBK-161

AN/PRC-5 RADIO SET

SHIPPING DATA

PKGS	VOLUME (Cu Ft)	WEIGHT (Lbs)
------	----------------	--------------

1

PROCUREMENT DATA

PROCURING SERVICE: USA
SPEC &/or DWG:

DESIGN COG: USA, Sig C

CONTRACTOR	LOCATION	CONTRACT OR ORDER NO.	APPROX UNIT COST
------------	----------	--------------------------	---------------------

RADIO SET AN/PRC-6()

1 July 1958

Cognizant Serv: USA FSN: 5820-194-9928

	USA	USN	USAF
TYPE CLASS:	Std	--	Std
STOCK NO:	2S3503-6	--	--



AN/PRC-6

FUNCTIONAL DESCRIPTION:

Radio Set AN/PRC-6() is the FM version of the "handie-talkie" Radio Set SCR-536 and operates in a single fixed-frequency channel selected by use of the appropriate crystal. This is low-power, short-range equipment that operates in the VHF range for line-of-sight communication by forward elements of armored, infantry, and artillery units.

This equipment consists of a light, self-contained receiver-transmitter having a built-in microphone and earphone, and provision for a loop antenna that is used for homing applications. It includes provision for connecting a conventional handset. The entire set, with battery installed, weighs 6.5 pounds.

The normal antenna is a built-in spring-steel ribbon extending from or retracting into the housing.

It operates from Battery BA-270/U (which is not supplied as part of this set) and includes the necessary crystal unit for the frequency on which the equipment is to operate.

TECHNICAL CHARACTERISTICS:

Frequency Range in Mc: 47.0 to 55.4

Type Modulation: FM

Type of Signal: Voice

Power Output: 0.25 w

Power Requirements: Battery BA-270/U

Transmitter: 1 amp at 1.5-v dc (1.5 w); 14 ma at 45-v dc (0.63 w); 28 ma at 90-v dc (2.52 w)

Receiver: 440 ma at 1.5-v dc (0.66 w); 13 ma at 45-v dc (0.585 w)

MIL-HDBK-161

AN/PRC-6() RADIO SET

MAJOR COMPONENTS

QTY	ITEM	STOCK NUMBERS	DIMENSIONS (Inches)	WEIGHT (Lbs)
		(FSN)		
1	Crystal Unit CR-23/U	-----	11/32 x 23/32 x 1-1/32	0.031
1	Handset H-33C/PT	5805-163-9947	1-1/2 x 8-3/8 x 3-1/4	.875
1	Radio Receiver-Transmitter RT-196/PRC-6	5820-194-9929	14-3/4 x 4-3/4 x 4-1/4	3.5

REFERENCE DATA AND LITERATURE:

TM 11-296, TM 11-4069

SHIPPING DATA

PKGS	VOLUME (Cu Ft)	WEIGHT (Lbs)
1	0.7	7 (without battery)

PROCUREMENT DATA

PROCURING SERVICE: USA
SPEC &/or DWG: MIL-R-10250

DESIGN COG: USA, Sig C

CONTRACTOR	LOCATION	CONTRACT OR ORDER NO.	APPROX UNIT COST
CBS-Columbia Manufacturing Co.	Brooklyn, N. Y.	15741-P-55-55	\$104.50
Emerson Radio & Phonograph Corp.	Jersey City, N. J.	2931-P-52-55	
Ratheon Manufacturing Co.	Waltham, Mass.	3319-P-52-55	185.93
Sentinal Radio Corp.	Evansville, Ill.	2873-P-52-37	

RADIO SET AN/PRC-7(XN-1)

25 November 1958

Cognizant Serv: USN FSN:

USA

USN

USAF

TYPE CLASS: --

Used by --

STOCK NO: --

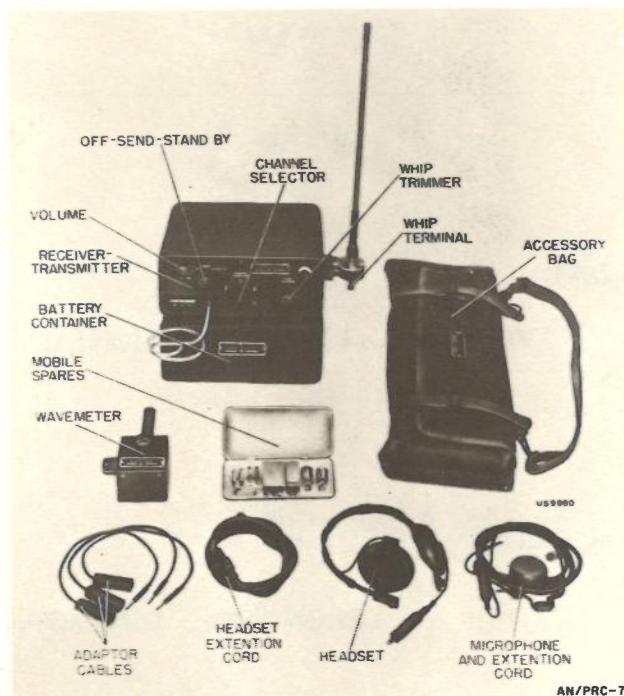

FUNCTIONAL DESCRIPTION:

Radio Set AN/PRC-7(XN-1) is a portable equipment designed for ground or vehicular use. It provides two-way radiophone communication over a 1-mile range. The set is lightweight and weatherproofed and employs subminiature

components and interchangeable plug-in intermediate frequency stages.

This equipment permits rapid selection of five preset channels for both reception and transmission. Instantaneous transfer from both reception and transmission is accomplished by microphone button-controlled relays.

TECHNICAL CHARACTERISTICS:

Transmitter:

Frequency Range in mc: 2 to 12
 Number of Channels: 5
 Frequency Control: Crystal
 Frequency Stability: 0.017% at 2 mc, 0.00567% at 12 mc
 Type Emission: A3
 Power Output: 0.8 w (RF average power)
 Input Impedance: 100 ohms
 Duty Cycle: 1 to 3 hr

Receiver:

Frequency range in mc: 2 to 15
 Number of Channels: 5
 Frequency Control: Crystal
 Type Receiver: Superheterodyne
 Intermediate Frequency: 1.6 mc
 Power Output: 75 mw maximum, 25 mw average, to headphones

Output Impedance: 300 ohms

Duty Cycle: 2 to 3 hr

Features: Interchangeable plug-in IF stages

Antenna Type: 10 ft 10 in; whip

Operational Range: 1 mile

Power Requirements: One Battery B-34 connected for 6 v
 Two Batteries B-35, 1-1/2 v, connected in parallel, and
 Six Batteries BA-53, 45 v, connected for 135-v output

MAJOR COMPONENTS

QTY	ITEM	STOCK NUMBERS	DIMENSIONS (Inches)	WEIGHT (Lbs)
1	Accessory bag, containing:		6 x 16 x 5	
3	Adaptor cable			
1	Battery cable			
1	Battery container		4-3/8 x 10-1/8 x 9-27/32	
1	Extension Cord 49576			
1	Headset Assembly 49507			

MIL-HDBK-161

AN/PRC-7(XN-1) RADIO SET

MAJOR COMPONENTS—Continued

QTY	ITEM	STOCK NUMBERS	DIMENSIONS (Inches)	WEIGHT (Lbs)
1	Microphone Assembly 51071			
1	Receiver-transmitter	-----	4-3/8 x 10-1/8 x 9-27/32	12
1	Set of spare tubes			
1	Shipping chest			
1	Wavemeter FR-20/U			

REFERENCE DATA AND LITERATURE:

NAVSHIPS 91389

SHIPPING DATA

PKGS	VOLUME (Cu Ft)	WEIGHT (Lbs)
1	5.7	

PROCUREMENT DATA

PROCURING SERVICE: USN
SPEC &/or DWG-

DESIGN COG: USN, BuShips

CONTRACTOR	LOCATION	CONTRACT OR ORDER NO.	APPROX UNIT COST
Radio Corp. of America, RCA Victor Division	Camden, N. J.		\$392.00

RADIO SET AN/PRC-8

1 July 1958

Cognizant Serv: USA FSN: 5820-253-6129

	USA	USN	USAF
TYPE CLASS:	Std	Std	--
STOCK NO:	2S3503-8	--	--

**FUNCTIONAL DESCRIPTION:**

Radio Set AN/PRC-8 is a portable (man-carried), low-power, FM (voice), radio transmitting and receiving equipment used for short-range, point-to-point, or radio relay communication in the frequency range assigned to armored divisions. It can also be installed in aircraft.

This equipment consists essentially of a radio transmitter-receiver equipped with a carrying harness, antenna components, and related accessories.

It can be operated by remote control and adapted for homing use by the addition of appropriate auxiliary components. The set can also be operated in a vehicle.

Two of these sets can be operated back-to-back as an unattended radio-relay station.

TECHNICAL CHARACTERISTICS:

Frequency Range in mc: 20.0 to 27.9

Type Modulation: FM

Type of Signal: Voice

Power Output: 1.2 w

Power Requirements: Battery BA-279/U (not supplied with set)

MIL-HDBK-161

AN/PRC-8 RADIO SET

MAJOR COMPONENTS

QTY	ITEM	STOCK NUMBERS	DIMENSIONS (Inches)	WEIGHT (Lbs)
		(USA)		
1	Antenna AT-271/PRC	2A204A-271	113 x 0.75 (diameter)	0.33
1	Antenna AT-272/PRC	2A204A-272	36.5 x 0.875 (diameter)	.5
1	Case CY-744/PRC	3B375-744	9.5 x 3 x 9.5	1.5
1	Handset H-33B/PT	2B620-33	3.5 x 3.5 x 8	.875
1	Radio Receiver-Transmitter RT-174/PRC-8	2C5130-174	9.5 x 3 x 10.5	9

REFERENCE DATA AND LITERATURE:

TM 11-612, TM 11-4065

SHIPPING DATA

PKGS	VOLUME (Cu Ft)	WEIGHT (Lbs)
1	4.85	40

PROCUREMENT DATA

PROCURING SERVICE: USA
SPEC &/or DWG: MIL-R-10273B

DESIGN COG: USA, Sig C

CONTRACTOR	LOCATION	CONTRACT OR ORDER NO.	APPROX UNIT COST
Admiral Corp.	Chicago, Ill.	3432-P-52-55	\$371.94
RCA, RCA Victor Division	New York, N. Y.	1758-P-51-37	326.37
Utility Electronics Corp.	----	23468-P-50-55	307.49
Western Electric Co. Inc.	New York, N. Y.	10575-P-55-55	218.25

1 July 1958

Cognizant Serv: USA FSN: 5820-254-9394

	USA	USN	USAF
TYPE CLASS:	Std	Used by	Std
STOCK NO:	--	--	--

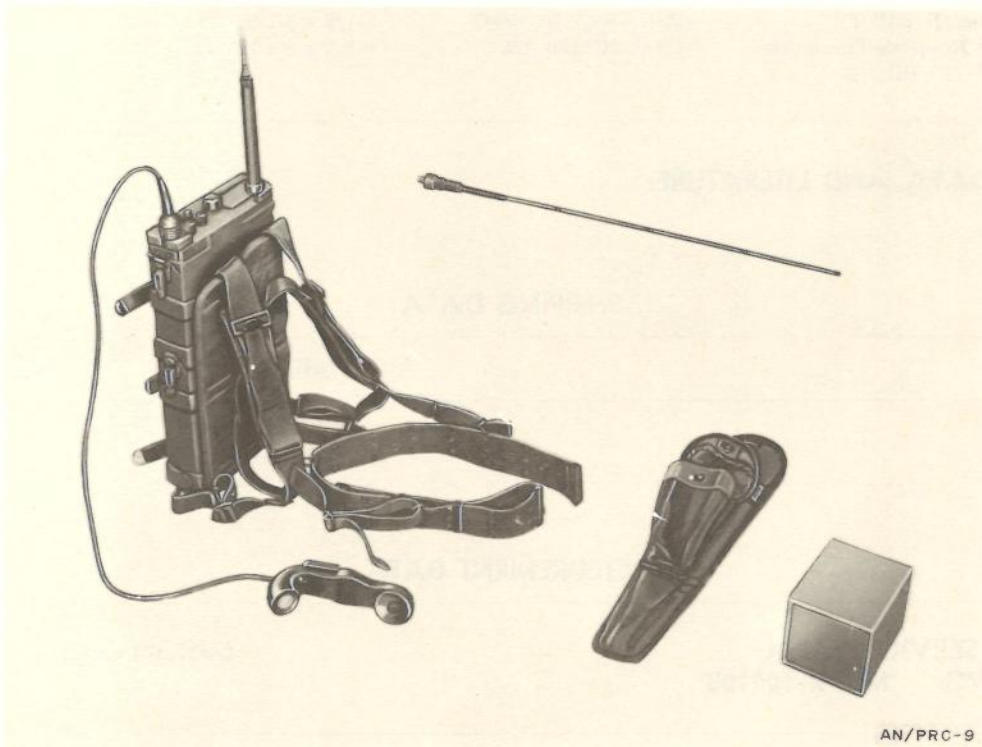

AN/PRC-9

FUNCTIONAL DESCRIPTION:

Radio Set AN/PRC-9() is a portable (man-carried), low-power, FM (voice), radio transmitting and receiving equipment used for VHF, short-range, point-to-point, or radio-relay communication in the frequency range assigned to artillery units. It can also be installed and operated in aircraft or motor vehicle.

This equipment consists essentially of a radio receiver-transmitter equipped with a carrying harness, antenna components, and related accessories.

It can be operated by remote control and adapted for

homing use by the addition of appropriate auxiliary components.

Two of these sets can be operated back-to-back as an unattended radio-relay station.

TECHNICAL CHARACTERISTICS:

Frequency Range in Mc: 27.0-38.9

Type Modulation: FM

Type of Signal: Voice

Power Output: 1 w

Power Requirements: Battery BA-279/U not supplied with equipment)

MIL-HDBK-161

AN/PRC-9() RADIO SET

MAJOR COMPONENTS

QTY	ITEM	STOCK NUMBERS	DIMENSIONS (Inches)	WEIGHT (Lbs)
1	Antenna AT-271/PRC	(FSN) 5820-242-4967	113 x 0.75 (diameter)	0.33
1	Antenna AT-272/PRC	(USA) 2A204A-272	36.5 x 0.875 (diameter)	.5
1	Case CY-744/PRC	(FSN) 6140-243-6318	9-1/2 x 3 x 9-1/2	1.5
1	Handset H-33B/PT	(FSN) 5965-163-9947	3-1/2 x 3-1/2 x 8	0.875
1	Radio Receiver-Transmitter RT-175/PRC-9	(USA) 2C5130-175	9-1/2 x 3 x 10-1/2	9

REFERENCE DATA AND LITERATURE:

TM 11-612

SHIPPING DATA

PKGS	VOLUME (Cu Ft)	WEIGHT (Lbs)
1	4.85	40

PROCUREMENT DATA

PROCURING SERVICE: USA
SPEC &/or DWG: MIL-R-10273B

DESIGN COG: USA, Sig C

CONTRACTOR	LOCATION	CONTRACT OR ORDER NO.	APPROX UNIT COST
Admiral Corp.	Chicago, Ill.	3432-P-52-55	\$371.94
Motorola, Inc.	Chicago, Ill.	21582-P-56-55	292.30
RCA, RCA-Victor Division	New York, N. Y.	15178-P-52-55	513.96
Utilities Electronics Corp.	----	23469-P-50-55	307.49
Western Electric Co. Inc.	New York, N. Y.	10575-P-55-55	292.25

RADIO SET AN/PRC-10()

1 July 1958

Cognizant Serv: USA FSN: 5820-223-5122

	USA	USN	USAF
TYPE CLASS:	Std	Used by	Std
STOCK NO:	2S3503-10	--	--

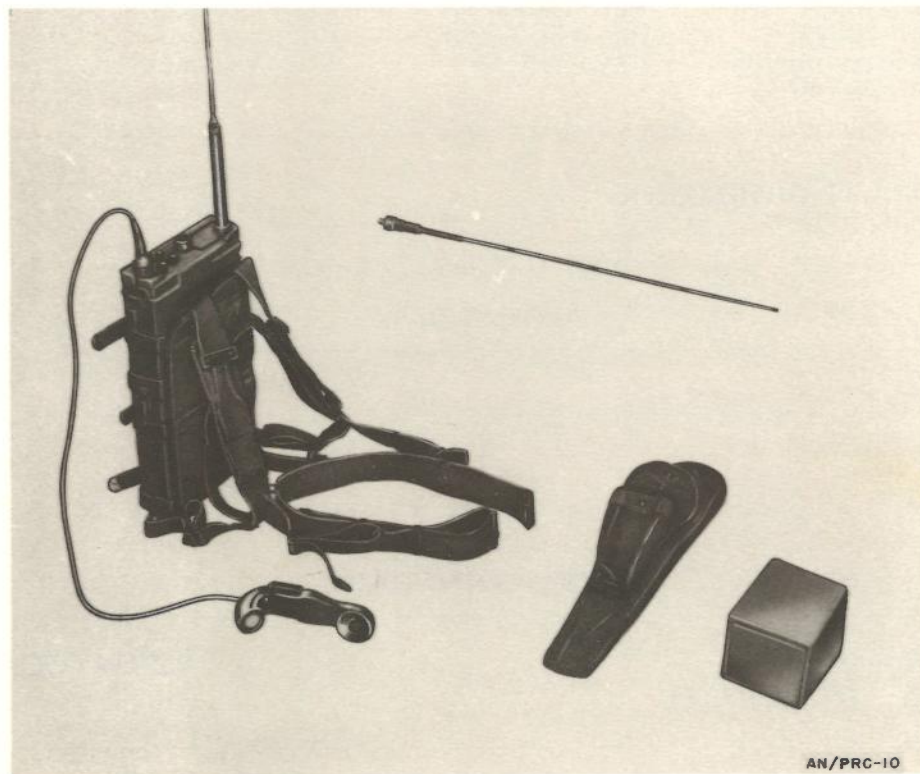

AN/PRC-10

FUNCTIONAL DESCRIPTION:

Radio Set AN/PRC-10() is a portable (man-carried), low-power, FM (voice), radio transmitting and receiving equipment used for VHF, short-range, point-to-point, or radio-relay communication in the frequency range assigned to infantry divisions. It can also be installed and operated in aircraft or motor vehicles.

This equipment consists essentially of a radio receiver-transmitter equipped with a carrying harness, antenna components, and related accessories.

It can be operated by remote control and adapted for homing use by the addition of appropriate auxiliary components.

Two of these sets can be operated back-to-back as an unattended radio-relay station.

TECHNICAL CHARACTERISTICS:

Frequency Range in Mc: 38.0 to 54.9

Type Modulation: FM

Type of Signal: Voice

Power Output: 0.9 w

Power Requirements: Battery BA-279/U (not supplied with equipment)

MIL-HDBK-161

AN/PRC-10() RADIO SET

MAJOR COMPONENTS

QTY	ITEM	STOCK NUMBERS	DIMENSIONS (Inches)	WEIGHT (Lbs)
1	Antenna AT-271/PRC	(FSN) 5985-242-4967	113 x 0.75 (diameter)	0.33
1	Antenna AT-272/PRC	(USA) 2A204A-272	36.5 x 0.75 (diameter)	.5
1	Case CY-744/PRC	(FSN) 6140-243-6318	9-1/2 x 3 x 9-1/2	1.5
1	Handset H-33B/PT	(FSN) 5805-163-9947	3-1/2 x 3-1/2 x 8	.875
i	Radio Receiver-Transmitter RT-176/PRC-10	(USA) 2C5130-176	9-1/2 x 3 x 10.5	9

REFERENCE DATA AND LITERATURE:

TM 11-612

SHIPPING DATA

PKGS	VOLUME (Cu Ft)	WEIGHT (Lbs)
1	4.85	40

PROCUREMENT DATA

PROCURING SERVICE: USA
SPEC &/or DWG: MIL-R-10273B

DESIGN COG: USA, Sig C

CONTRACTOR	LOCATION	CONTRACT OR ORDER NO.	APPROX UNIT COST
Admiral Corp.	Chicago, Ill.	3432-P-52-55	\$533.67
RCA-RCA Victor Division	New York, N. Y.	15178-P-52-55	592.78
Utility Electronics Corp.	----	23468-P-50-55	307.49

1 July 1958

Cognizant Serv: USA FSN: 5820-249-6594

	USA	USN	USAF
TYPE CLASS:	Std	--	--
STOCK NO:	2S3503-16	--	--

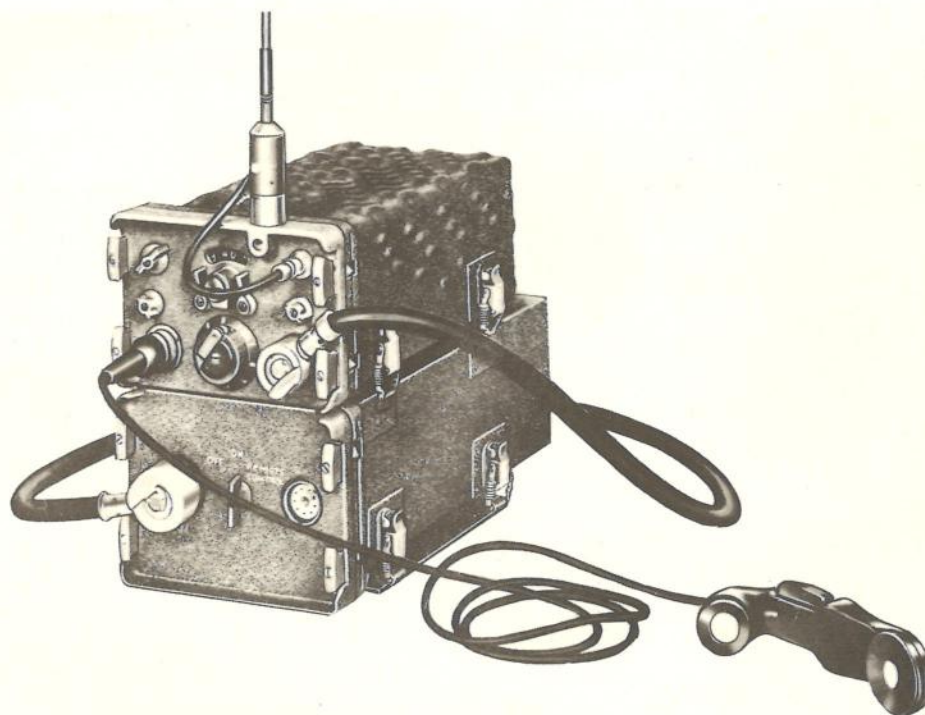

AN/PRC-16

FUNCTIONAL DESCRIPTION:

Radio Set AN/PRC-16 is a portable, lightweight, low-power, short-range, battery operated, FM (voice) equipment for two-way ground-to-ground or ground-to-air communication in the VHF range.

This set consists of the separate, short-range, low-power receiver-transmitter component designated as set 2 when used as part of radio sets of the integrated series such as Radio Sets AN/GRC-3 through AN/GRC-8. Antenna system, battery box, handset, and accessories are included.

This equipment can be operated from a remote point over a telephone pair up to a distance of about 2 miles by means of Control Group AN/GRA-6.

TECHNICAL CHARACTERISTICS:

Frequency Range in Mc: 47 to 58.4

Type Modulation: FM

Type of Signal: Voice

Power Output: 0.5 w

Power Requirements: Five 1.5-v Batteries BA-403/U, one 90-v Battery BA-419/U

MIL-HDBK-161

AN/PRC-16 RADIO SET

MAJOR COMPONENTS

QTY	ITEM	STOCK NUMBERS	DIMENSIONS (Inches)	WEIGHT (Lbs)
		(FSN)		
1	Case CY-590/GRC	5820-404-7320	5-1/2 x 8 x 15-3/4	7
1	Handset H-33/PT	5965-163-9947	3 x 2-1/16 x 3	2
1	Receiver-Transmitter RT-70/GRC	5820-537-3913	4-3/4 x 13 x 7-7/8	25

REFERENCE DATA AND LITERATURE:

TM 11-288

SHIPPING DATA

PKGS	VOLUME (Cu Ft)	WEIGHT (Lbs)
1	----	45

PROCUREMENT DATA

PROCURING SERVICE: USA

DESIGN COG: USA, Sig C

SPEC &/or DWG: Depot Assembled

CONTRACTOR	LOCATION	CONTRACT OR ORDER NO.	APPROX UNIT COST
------------	----------	--------------------------	---------------------

RADIO SET **AN/PRC-17**

25 November 1958

Cognizant Serv: USN FSN:

USA

USN

USAF

TYPE CLASS: --

Used by --

STOCK NO: --

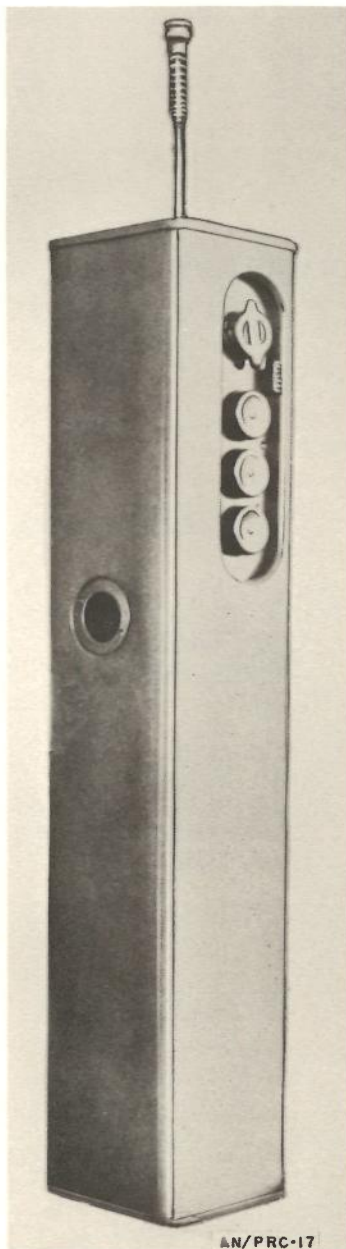

AN/PRC-17

FUNCTIONAL DESCRIPTION:

Radio Set AN/PRC-17 is a hand-held, lightweight, emergency search and rescue transmitter-receiver designed to provide two-way voice communication between a life raft and searching ships or aircraft. It also provides for the transmission of an audio tone which may be continuous or keyed at a slow rate.

All components of this equipment are contained in a watertight metal case. The receiver is of the superregenerative type and operates at either of the two frequencies selected for the transmitter.

TECHNICAL CHARACTERISTICS:

Frequency Range in Mc: 121.5 to 243

Type Modulation: AM

Type Emission: A2, A3 (mcw, voice)

Frequency Control: Crystal

Type Antenna: Whip

Power Output: 50 mw

Power Requirements: 1.57 w, 5.4- to 105-v, dc (from self-contained batteries) B voltage; 135 v, dc (A voltage) 1.1- to 1.34-v dc

Battery Life:

Transmitting: 20 hr

Receiving: 15 hr

MIL-HDBK-161

AN/PRC-17 RADIO SET

MAJOR COMPONENTS

QTY	ITEM	STOCK NUMBERS	DIMENSIONS (Inches)	WEIGHT (Lbs)
1	Radio Set AN/PRC-17	-----	14-3/4 x 2-5/8 x 2-7/8	

REFERENCE DATA AND LITERATURE:

SHIPPING DATA

PKGS	VOLUME (Cu Ft)	WEIGHT (Lbs)
------	----------------	--------------

PROCUREMENT DATA

PROCURING SERVICE: USN

DESIGN COG: USn, BuAer

SPEC &/or DWG: MIL-R-7121 (Aer)

CONTRACTOR	LOCATION	CONTRACT OR ORDER NO.	APPROX UNIT COST
Telephonics Corp.	Huntington, N. Y.	NOas-51-216	\$210.00
		NOas-52-798	210.00
		NOas-53-555, 29 April 1953	210.00
		NOas-53-1019, 13 July 1953	210.00
		NOas-10361	210.00

RADIO SET AN/PRC-21()

1 July 1958

Cognizant Serv: USA FSN:

USA

USN

USAF

TYPE CLASS: Std

STOCK NO: --

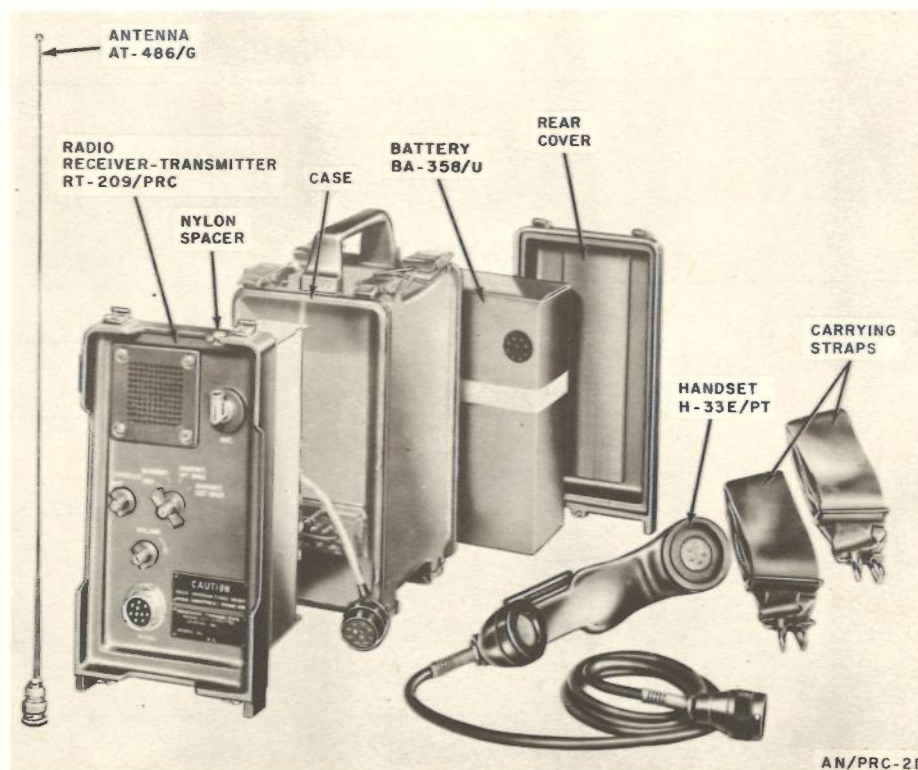
**FUNCTIONAL DESCRIPTION:**

Radio Set AN/PRC-21() is a low-power, portable, FM transmitter-receiver used by military police, guards, and security forces.

This equipment consists essentially of a radio transmitter-receiver, handset, antenna, and carrying straps. It is powered by a dry battery that is not supplied with the equipment.

This set is intended for nontactical purposes.

TECHNICAL CHARACTERISTICS:

Frequency Range in Mc: 152 to 174

Type Modulation: FM

Type of Signal: Voice

Power Output: 150 mw

Power Requirements: Battery BA-358/U

MAJOR COMPONENTS

QTY	ITEM	STOCK NUMBERS	DIMENSIONS (Inches)	WEIGHT (Lbs)
-----	------	---------------	------------------------	-----------------

1	Radio Set AN/PRC-21() (Equipment consists of a single major operating assembly.)			
---	--	--	--	--

MIL-HDBK-161

AN/PRC-21() RADIO SET

REFERENCE DATA AND LITERATURE:

TM 11-610
TO 31R2-2PRC21-11

SHIPPING DATA

PKGS	VOLUME (Cu Ft)	WEIGHT (Lbs)
1	0.69	30

PROCUREMENT DATA

PROCURING SERVICE: USA
SPEC &/or DWG: MIL-R-14028

DESIGN COG: USA, Sig C

CONTRACTOR	LOCATION	CONTRACT OR ORDER NO.	APPROX UNIT COST
Motorola, Inc.	Chicago, Ill.	08709-P-55-93	\$484.00

RADIO SET **AN/PRC-23, 24**

1 July 1958

Cognizant Serv: USA FSN: AN/PRC-23: 5820-194-9926
 AN/PRC-24: 5820-194-9927

	USA	USN	USAF
TYPE CLASS:	L/Std	--	--
STOCK NO:	AN/PRC-23: 2S3503-23	--	--
	AN/PRC-24: 2S3503-24		

**FUNCTIONAL DESCRIPTION:**

Radio Set AN/TRC-23 (Motorola Model FHTR-1BLL) and Radio Set AN/PRC-24 (Motorola Model FHTR-1BH) are self-contained, short-range, single frequency, low-power, battery-operated, FM (voice) transmitting and receiving equipment capable of providing two-way communication up to 1.5 miles over average terrain.

Both sets are pretuned to the selected frequency within their respective ranges. Realignment of the individual stages of the transmitter and receiver is required to change the operating frequency of either one.

The major difference between the AN/PRC-23 and AN/PRC-24 is the frequency band in which they operate.

TECHNICAL CHARACTERISTICS:

Frequency Range in Mc:

AN/PRC-23: 25 to 30

AN/PRC-24: 40 to 50

Type Modulation: FM

Type of Signal: Voice, mcv

Power Output: 500 mw

Power Requirements: Six 1.5-v Batteries BA-30 and three 67.5-v Batteries BA-51; provides 6 to 8 hours continuous operation

MIL-HDBK-161

AN/PRC-23, 24 RADIO SET

MAJOR COMPONENTS

QTY	ITEM	STOCK NUMBERS	DIMENSIONS (Inches)	WEIGHT (Lbs)
1	Antenna AT-348/PRC	(FSN) 5985-221-9042		
1	Handset	(FSN) 5805-237-8047		
1	Housing			
1	Power supply chassis			
1	Transmitter-Receiver RT-235/ PRC (AN/PRC-24)	(USA) 2C 5612	12-5/8 x 3-1/8 x 12-1/2	14.9
	or			
	Transmitter Receiver RT-236/ PRC (AN/PRC-23)	(USA) 2 C 5611	12-5/8 x 3-1/8 x 12-1/2	14.9

REFERENCE DATA AND LITERATURE:

Commercial Instruction Book

SHIPPING DATA

PKGS	VOLUME (Cu Ft)	WEIGHT (Lbs)
------	----------------	--------------

PROCUREMENT DATA

PROCURING SERVICE: USA
SPEC &/or DWG:

DESIGN COG: USA, Sig C

CONTRACTOR	LOCATION	CONTRACT OR ORDER NO.	APPROX UNIT COST
------------	----------	--------------------------	---------------------

25 November 1958

Cognizant Serv: USN FSN: 5820-503-2585
5820-644-4823 (USN)

USA

USN

USAF

TYPE CLASS:

--

Used by

--

STOCK NO:

2S3503-28

--

--

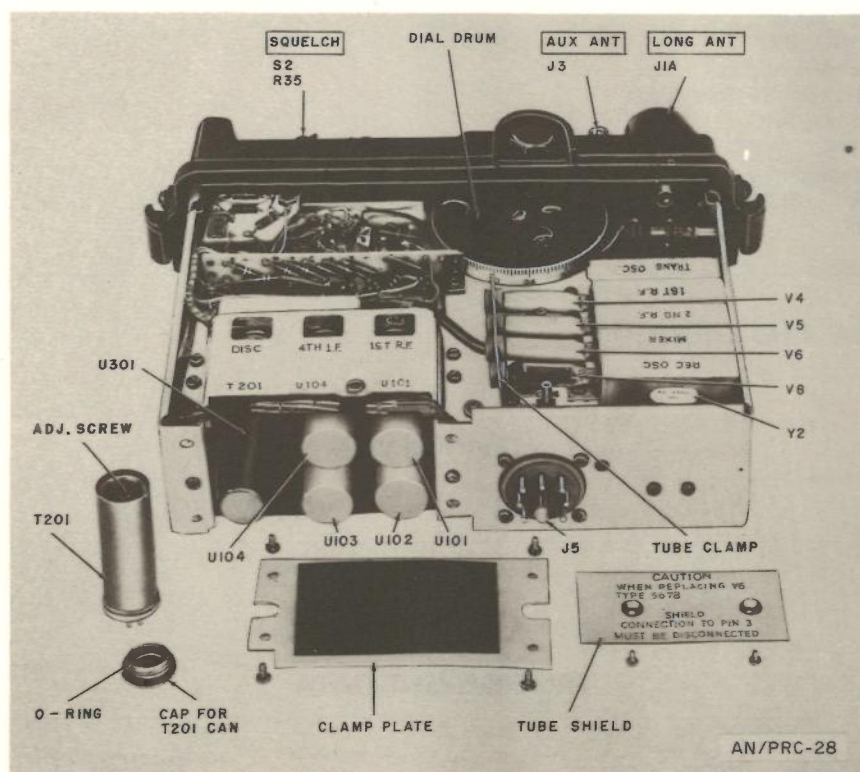
**FUNCTIONAL DESCRIPTION:**

Radio Set AN/PRC-28 is a portable, pack mounted, frequency modulated, transmitter and receiver designed for single channel voice operation.

This equipment obtains its operational power from Battery BA-279()/U.

The radio set is similar to, but not interchangeable with, Radio Set AN/PRC-10().

TECHNICAL CHARACTERISTICS:

Frequency Range in Mc: 30 to 42

Number of Channels: 1

Frequency Control: Crystal

Type Emission and Reception: Voice

Type Modulation: FM

Type of Receiver: Superheterodyne

Power Output: 0.9 w

Power Requirements: Battery BA-279()/U

RADIO SET **AN/PRC-29**

25 November 1958

Cognizant Serv: USN FSN: 5820-665-1219

USA

USN

USAF

TYPE CLASS: --

Used by --

STOCK NO: --

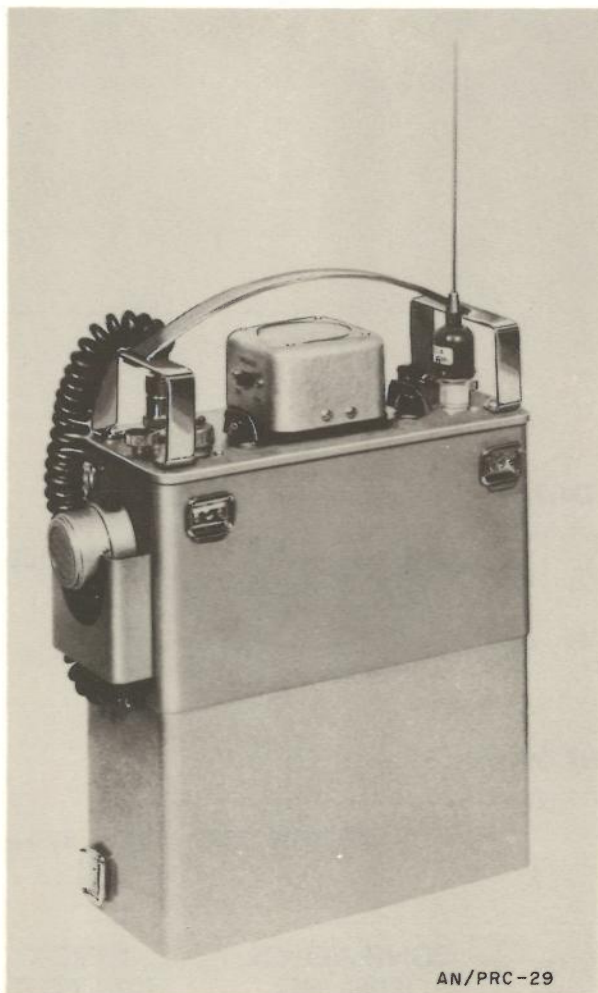

AN/PRC-29

FUNCTIONAL DESCRIPTION:

Radio Set AN/PRC-29 is a portable, man-carried, two-way, low-power transmitting and receiving equipment. It is contained in a single housing and provides dependable communications over average terrain for a nominal distance of 1 to 2 miles. Increased range can be obtained by elevating the antenna above the surrounding terrain.

The set is used by guards and security police for communication during internal security and industrial control operations. However, it may be employed in various tactical situations.

This equipment consists essentially of a commercial Motorola Model X-11-1A radio receiver-transmitter equipped with a carrying harness, antenna, and related accessories.

TECHNICAL CHARACTERISTICS:

Frequency Range in Mc: 30 to 42

Type Modulation: FM

Type Emission and Reception: F3 (voice)

Type of Control: Crystal

Transmitter Radio Frequency Power Output: 750 mw

Transmitter Modulation: ± 15 kc for 100%

Transmitter Audio Input: 0.3 v

Receiver Sensitivity: 0.5 mv

Receiver Selectivity: 75 db

Receiver Audio Output: 100 mw

Power Requirements: Three 45-v (Burgess-type M-30) B batteries or equivalent (p); two 1.5-v std 4F-size batteries (fil)

MIL-HDBK-161

AN/PRC-29 RADIO SET

MAJOR COMPONENTS

QTY	ITEM	STOCK NUMBERS	DIMENSIONS (Inches)	WEIGHT (Lbs)
1	Radio Set AN/PRC-29 consists of:	-----	5 x 12-1/8 x 15-1/8	23.7
1	Antenna P-8653-A	-----	43	
1	Battery Power Supply P-9096			
1	Carrying Case K-9099			
1	Carrying Strap Kit K-9098			
1	Channel Receiver Assembly TA-124			
1	Channel Transmitter Assembly TA120			
1	Control Panel TU135-N			
1	Microphone P-9094-A			

REFERENCE DATA AND LITERATURE:

NAVSHIPS 92759

SHIPPING DATA

PKGS	VOLUME (Cu Ft)	WEIGHT (Lbs)
1	0.5	23.7

PROCUREMENT DATA

PROCURING SERVICE: USN

DESIGN COG: USN, BuShips

SPEC &/or DWG:

CONTRACTOR	LOCATION	CONTRACT OR ORDER NO.	APPROX UNIT COST
Motorola Communications and Electronics Division	Chicago, Ill.	NObsr-64259, 20 September 1954	

RADIO SET **AN/PRC-33**

25 November 1958

Cognizant Serv: **USN** FSN: 5820-642-7724

	USA	USN	USAF
TYPE CLASS:	--	Used by	--
STOCK NO:	--	--	--



AN/PRC-33

FUNCTIONAL DESCRIPTION:

Radio Set AN/PRC-33 is a lightweight, short-range, receiving and transmitting unit designed for two-way communication. It is supplied as a complete item to fulfill the requirements for a portable station.

The set may be hand- or back-carried. It may also be used as a semifixed unit by setting it up on the ground if so required.

This equipment consists essentially of a militarized version of Industrial Radio Corporation, Type PS-40, Model HC radio set. It is normally resistant to dust and rain. A weather-proof canvas case is used to protect the item under extreme weather conditions.

TECHNICAL CHARACTERISTICS:

Frequency Range in Mc: 30 to 42

Type Modulation: FM

Type Emission and Reception: F3 (voice)

Spurious Responses: 75 db

Operational Range:

Normal: 2 miles

Maximum: 10 miles

Transmitter:

Frequency Deviation: ± 15 kc

Frequency Stability: $\pm 0.005\%$

Spurious Radiation: 40 db

Power Output: $3/4$ w

Receiver:

Sensitivity: 0.5 mv

Selectivity: 75 db ± 8 kc

Audio Output: 0.1 w

Power Requirements: 1.5-v dc (fil); 45-v dc; 135-v dc (battery operated)

MAJOR COMPONENTS

QTY	ITEM	STOCK NUMBERS	DIMENSIONS (Inches)	WEIGHT (Lbs)
1	Antenna AT-673/PRC-33			
3	Battery, Burgess B, No. M39			
1	Battery, Burgess A, No. 8F			
1	Case, Receiver-Transmitter CY-1916/PRC-33	-----	4-1/2 x 10 x 11-1/2	15
1	Microphone			
1	Radio Receiver-Transmitter RT-359/PRC-33			

MIL-HDBK-161

AN/PRC-33 RADIO SET

REFERENCE DATA AND LITERATURE:

NAVSHIPS 92651

SHIPPING DATA

PKGS	VOLUME (Cu Ft)	WEIGHT (Lbs)
-------------	-----------------------	---------------------

PROCUREMENT DATA

PROCURING SERVICE: USN
SPEC &/or DWG:

DESIGN COG: USN, BuShips

CONTRACTOR	LOCATION	CONTRACT OR ORDER NO.	APPROX UNIT COST
Industrial Radio Corp.	Chicago, Ill.	NObsr-64749, 14 September 1955	

RADIO SET **AN/PRC-37**

25 November 1958

Cognizant Serv: USAF FSN: 5820-

	USA	USN	USAF
TYPE CLASS:	--	--	Tent-Std
STOCK NO:	--	--	--

(No Illustration Available)

FUNCTIONAL DESCRIPTION:

Radio Set AN/PRC-37 is a portable, lightweight communication unit generally used by air-police and air-rescue teams. It is a single band, transistorized set with an operational range of 70 to 80 miles at an 8,000-foot altitude in air-rescue operations.

This equipment essentially replaces Radio Set AN/PRC-21.

TECHNICAL CHARACTERISTICS:

Frequency Range in Mc: 144 to 174

Number of Bands: 1

Type Modulation: FM

Type Emission: F3 (voice)

Power Output: 1 w (maximum)

Power Requirements: 6- or 12-v battery (rechargeable)

MAJOR COMPONENTS

QTY	ITEM	STOCK NUMBERS	DIMENSIONS (Inches)	WEIGHT (Lbs)
1	Antenna			
1	Battery (rechargeable)			
1	Carry strap			
1	Case			
1	Loudspeaker			
1	Microphone			
1	Power supply			
1	Radio receiver			
1	Radio transmitter			

REFERENCE DATA AND LITERATURE:

SHIPPING DATA

PKGS	VOLUME (Cu Ft)	WEIGHT (Lbs)

MIL-HDBK-161

AN/PRC-37 RADIO SET

PROCUREMENT DATA

PROCURING SERVICE: USAF
SPEC &/or DWG:

DESIGN COG: USAF, RCUE

CONTRACTOR	LOCATION	CONTRACT OR ORDER NO.	APPROX UNIT COST
------------	----------	--------------------------	---------------------

RADIO TRANSMITTING AND RECEIVING EQUIPMENT **AN/PRC-type**

3 December 1958

Cognizant Serv: USN FSN:

MAB

USA

USN

USAF

TYPE CLASS: --

Used by --

STOCK NO: --

F16-Q-176014-200 --

(No Illustration Available)

FUNCTIONAL DESCRIPTION:

Radio Transmitting and Receiving Equipment MAB is an ultraportable voice communication equipment designed as a single-frequency, crystal-controlled, amplitude-modulated link between paratroop forces. The equipment is also suitable for reconnaissance of outpost communications. The transmitter

has no manual tuning knob but is pretuned by means of a screwdriver control.

TECHNICAL CHARACTERISTICS:

Frequency Range in Mc: 2.3 to 4.5 (preset to one frequency)

Power Output: 0.2 w

Effective Range: 1 mile over average terrain

Power Requirements: Battery Pack 19027-A; or Lead-Acid Storage Battery 19046 with Vibrator Power Unit 20221

MAJOR COMPONENTS

QTY	ITEM	STOCK NUMBERS	DIMENSIONS (Inches)	WEIGHT (Lbs)
1	Antenna Assembly 66081	-----	15-1/8 high (collapsed); 85 high (extended)	1
1	Battery Pack 19027-A	-----	6-1/2 x 3-5/8 x 1-13/16	2
1	Case 10162	-----	9 x 3 x 3	
1	Headset Assembly 49214	-----		.25
1	Microphone and Cover Assembly 51048	-----		1
1	Power Supply Vibrator 20211	-----	6-9/16 x 3-11/16 x 1-7/8	
1	Storage Battery 19046	-----	2-3/8 x 1-25/32 x 3-9/16	
1	Transmitter-Receiver 43045, including battery, power unit, and case	-----	6-1/4 x 3-9/16 x 1-13/16	1.25

REFERENCE DATA AND LITERATURE:

NAVSHIPS 95121

SHIPPING DATA

PKGS	VOLUME (Cu Ft)	WEIGHT (Lbs)
1	0.2	9.7

MIL-HDBK-161

AN/PRC-type RADIO TRANSMITTING AND RECEIVING EQUIPMENT

PROCUREMENT DATA

PROCURING SERVICE: USN
SPEC &/or DWG:

DESIGN COG: USN, BuSI

CONTRACTOR	LOCATION	CONTRACT OR ORDER NO.	APPROX UNIT COS
Communications Co., Inc.	Coral Gables, Fla.	NXss-14439	\$100

PORTABLE VHF RADIO TRANSMITTING AND RECEIVING EQUIPMENT **AN/PRC-type**

8 December 1958

Cognizant Serv: USN FSN:

MAW, MAW-1

	USA	USN	USAF
TYPE CLASS:	--	Used by	--
STOCK NO:	--	--	--



MAW

FUNCTIONAL DESCRIPTION:

Portable VHF Radio Transmitting and Receiving Equipment MAW or MAW-1 is a low-power, very-high-frequency pack-type communication set used in ground-to-air liaison, ship, or shore based emergency communication. The entire equipment, including accessories, is contained in a portable submersion-proof case. It is capable of modulated continuous wave and voice transmission and reception on any of 10 preset crystal-controlled channels.

This equipment is powered by two 2-volt storage batteries and a vibrator-type power pack. The batteries are of the dry-charged type, and 24 ounces of 1.265 specific gravity sulfuric acid is required. Battery charging can be accomplished by

connection to a 6-volt storage battery or other source of low voltage dc power.

TECHNICAL CHARACTERISTICS:

Frequency Range in Mc: 115 to 156

Type of Modulation: AM

Type of Signal: Voice, mcw

Power Output:

Transmitter: 0.7 w

Receiver: 0.025 w into 600-ohm load

Power Requirements:

Transmitter: 135-v dc

Receiver: 100-v dc

Filament: 1.5- and 3-v dc

AN/PRC-type PORTABLE VHF RADIO TRANSMITTING AND RECEIVING EQUIPMENT

MAJOR COMPONENTS

QTY	ITEM	STOCK NUMBERS	DIMENSIONS (Inches)	WEIGHT (Lbs)
<i>For MAW:</i>				
1	Radio Transmitter-Receiver NT-43069 including battery assembly	-----	5-3/8 x 14-1/2 x 17-15/16	42
2	Antenna Assembly NT-66150	-----	1-1/2 x 1-1/2 x 19	.75
1	Shipping Chest NT-10543	-----	12-3/4 x 16-1/2 x 25	35.6
<i>For MAW-1:</i>				
1	Radio Transmitter-Receiver NT-43069A including battery assembly	-----	5-3/8 x 14-1/2 x 18	42
2	Antenna Assembly NT-66150	-----	1-1/2 x 1-1/2 x 19	.75
1	Shipping Chest NT-10543	-----	12-3/4 x 16-1/2 x 25	35.6

REFERENCE DATA AND LITERATURE:

MAW: NAVSHIPS 900734

MAW-1: NAVSHIPS 91529(A)

SHIPPING DATA

PKGS	VOLUME (Cu Ft)	WEIGHT (Lbs)
<i>For MAW:</i> 1	6.54	137
<i>For MAW-1:</i> 1	7.07	178

PROCUREMENT DATA

PROCURING SERVICE: USN
SPEC &/or DWG:

DESIGN COG: USN, BuShips

CONTRACTOR	LOCATION	CONTRACT OR ORDER NO.	APPROX UNIT COST
Howard Radio Co. Hoffman Radio Corp.	Chicago, Ill. Los Angeles, Calif.	NXsr-77870 NObsr-52170, 15 De- cember 1950)	\$1/600 (MAW) 1,750 (MAW-1)

PORTABLE RADIO TRANSMITTING AND RECEIVING EQUIPMENT **AN/PRC-type**

8 December 1958

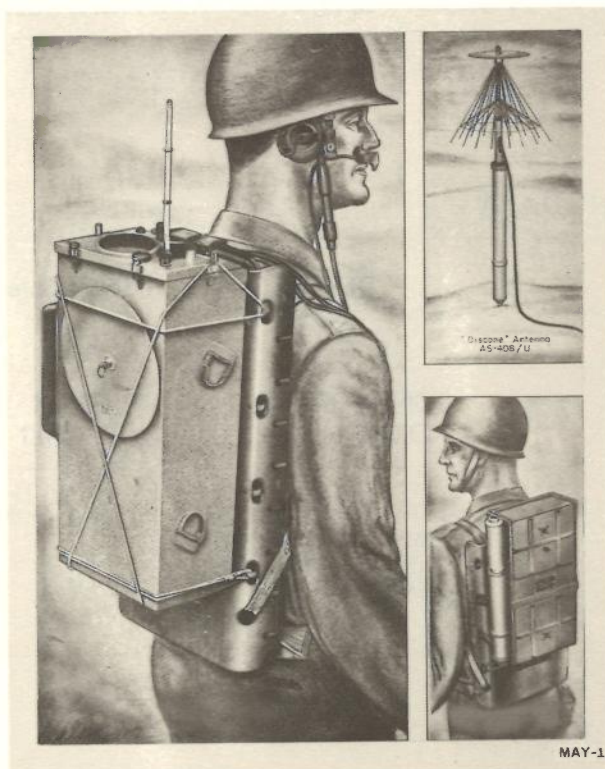
Cognizant Serv: **USN FSN:****MAY, MAY-1****USA****USN****USAF**TYPE CLASS: --
STOCK NO: --Used by --
--**FUNCTIONAL DESCRIPTION:**

Portable Radio Transmitting and Receiving Equipment MAY and MAY-1 are general service, am, low-power VHF/UHF transmitter-receiver equipments designed for pack-board operation in the field.

Four preset crystal-controlled channels are provided for the transmitter receiver. It is designed for use with a collapsible broad-band antenna of the ground-plane type, but will operate with a collapsible whip-type array.

TECHNICAL CHARACTERISTICS:*Frequency Range:* 225-390 mc*Type of Modulation:* AM*Type of Signal:* Mcw, voice*Power Output:*

Transmitter: 1 w into 50 ohm load

Receiver: 25 mw into 300 ohm load

Power Requirements: Self-contained 6-v dc lead-acid storage battery capable of 4 hours continuous operation at a duty cycle of 3 to 1

MAJOR COMPONENTS

QTY	ITEM	STOCK NUMBERS	DIMENSIONS (Inches)	WEIGHT (Lbs)
1	Transmitter-Receiver NT-43071 (MAY), or NT-43071-A (MAY-1)	-----	10 x 13-1/8 x 23-13/16	44
2	Discone Antenna AS-408/U	-----	2-5/16 dia x 20-9/16 (folded) 17-1/2 x 46 (fully extended)	2.75
1	Auxiliary Battery Pack NT-19062	-----	5-1/2 x 11-7/8 x 20-5/8	42

RADIO SET AN/PRC-type

1 July 1958

Cognizant Serv: USA FSN: 5820-186-9200

SCR-300

USA

USN

USAF

TYPE CLASS:

L/Std

Used by

--

STOCK NO:

2S300

--

--

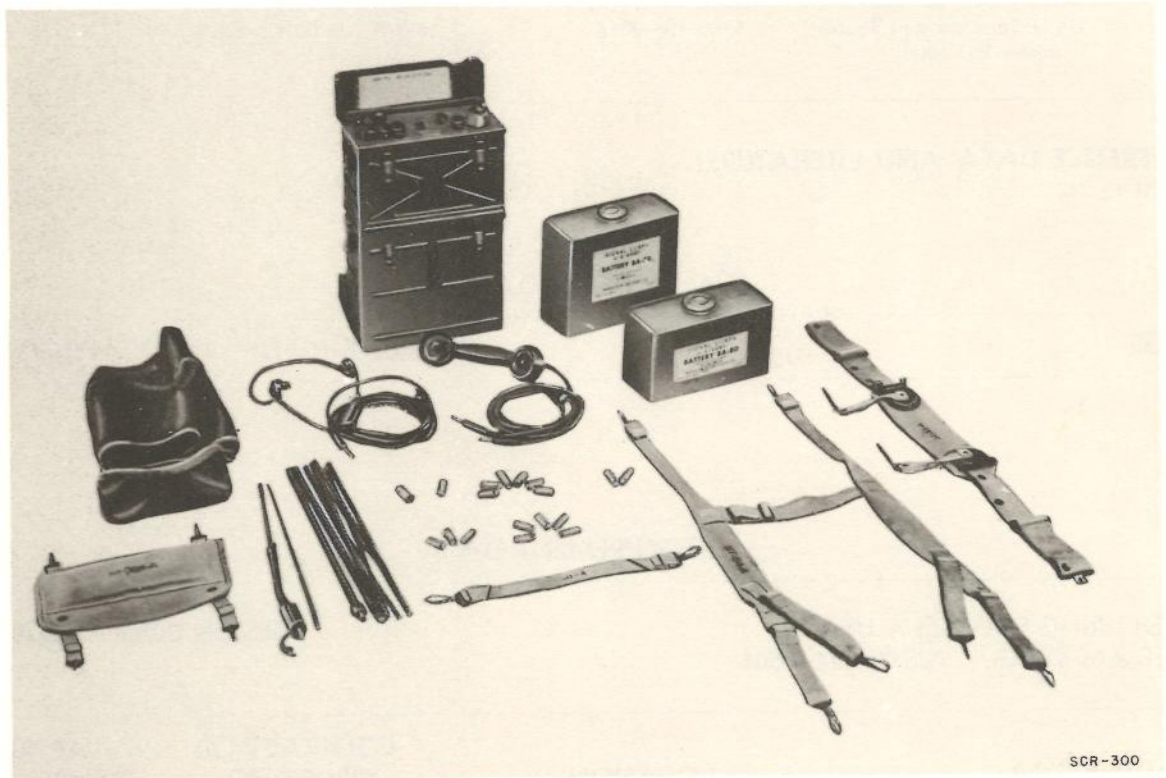

SCR-300

FUNCTIONAL DESCRIPTION:

Radio Set SCR-300 is a portable, short-range, low-power, FM (voice) transmitting and receiving equipment used for communication by foot troops.

This equipment consists of a transmitter-receiver contained in a metal housing, the lower portion of which is the battery compartment, and includes a flexible, whip-type antenna. It may be operated on the ground or while being carried by the operator or a "bearer" and may be installed in aircraft or vehicles. A handset with a press-to-talk switch is included but

the equipment can be operated by means of headphones and microphone.

The vehicular version of this equipment is Radio Set AN/VRC-3.

TECHNICAL CHARACTERISTICS:

Frequency Range in Mc: 40 to 48

Type Modulation: FM

Type of Signal: Voice

Power Output: 0.3 w

Power Requirements: Battery BA-80

MIL-HDBK-161

AN/PRC-type RADIO SET

MAJOR COMPONENTS

QTY	ITEM	STOCK NUMBERS	DIMENSIONS (Inches)	WEIGHT (Lbs)
		(FSN)		
1	Battery Case CS-139	-----	9-3/8 x 10-15/16 x 7-1/4	3.66
1	Radio Receiver and Transmitter BC-1000	5820-196-9042	5-5/8 x 11-5/16 x 7-1/8	13

REFERENCE DATA AND LITERATURE:

TM 11-242

SHIPPING DATA

PKGS	VOLUME (Cu Ft)	WEIGHT (Lbs)
1	3	44.5

PROCUREMENT DATA

PROCURING SERVICE: USA
SPEC &/or DWG: (USA) 271-1601

DESIGN COG: USA, Sig C

CONTRACTOR	LOCATION	CONTRACT OR ORDER NO.	APPROX UNIT COST
Phileo Corp. (U.S. Marine Corps) (Bureau of Ships)	Philadelphia, Pa. ----	29316-P-44-01 R-54-0363-SC-43	\$186.37

RADIO SET **AN/PRC-type**

1 July 1958

Cognizant Serv: USA FSN: 5820-193-7119

SCR-509-()

USA

USN

USAF

TYPE CLASS: L/Std
STOCK NO: 2S509

Used by

--

--

--

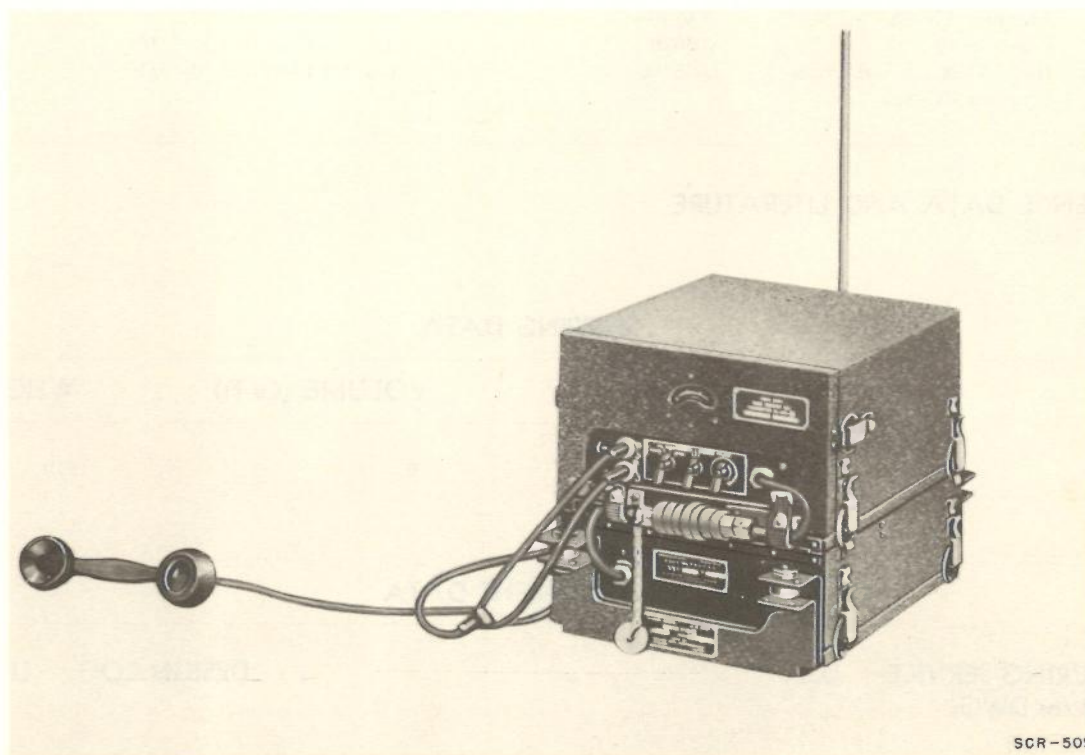

SCR-509

FUNCTIONAL DESCRIPTION:

Radio Set SCR-509-() is a portable, short-range, low-power, FM (voice only), radio receiving and transmitting equipment used by armored units. The set is designed for operation on the ground but can be installed in a vehicle.

This equipment consists of a receiver-transmitter, a metal case containing the batteries, an antenna, and related accessories. The receiver-transmitter is mounted on the battery case by means of trunk-type clasps. It provides 80 crystal-controlled channels spaced 100 kc apart, two of which can be preset.

It can be operated from a remote point over a telephone pair by means of standard remote control apparatus.

This set, when installed in a vehicle (with appropriate antenna and power supply) is designated as Radio Set SCR-510.

TECHNICAL CHARACTERISTICS:

Frequency Range in Mc: 20.0 to 27.9

Type Modulation: FM

Type of Signal: Voice

Power Output: 1.8 w

Power Requirements: Battery BA-39, Battery BA-40, and Battery BA-41

MIL-HDBK-161

AN/PRC-type RADIO SET

MAJOR COMPONENTS

QTY	ITEM	STOCK NUMBERS	DIMENSIONS (Inches)	WEIGHT (Lbs)
		(USA)		
1	Antenna AN-45	2A245	-----	0.63
1	Case CS-79	3B879	4-1/2 x 13-3/16 x 15-9/16	10
1	Radio Receiver and Trans- mitter BC-620	2C5360	6-3/4 x 13-3/16 x 14-15/16	27.20

REFERENCE DATA AND LITERATURE:

TM 11-605

SHIPPING DATA

PKGS	VOLUME (Cu Ft)	WEIGHT (Lbs)
3	9	210

PROCUREMENT DATA

PROCURING SERVICE: USA
SPEC &/or DWG:

DESIGN COG: USA, Sig C

CONTRACTOR	LOCATION	CONTRACT OR ORDER NO.	APPROX UNIT COST
------------	----------	--------------------------	---------------------

RADIO SET **AN/PRC-type**

1 July 1958

Cognizant Serv: USA FSN:

SCR-536

USA

USN

USAF

TYPE CLASS: L/Std
 STOCK NO: 2S536

Used by

--

--



SCR-536

FUNCTIONAL DESCRIPTION:

Radio Set SCR-536 is a highly portable, hand-held, short-range, transmitting and receiving equipment for AM (voice) communication by foot-troops in forward areas.

This equipment consists of a crystal-controlled transmitter-receiver contained in a metal housing that also contains the batteries and in which the earphone and microphone are assembled. The set is turned on or off by extending or retracting the telescoping antenna that is built into the set. A press-to-talk switch is mounted on the side of the housing.

This set can operate on one of 50 available frequency channels, any one of which can be preselected.

This equipment has been replaced by Radio Set AN/PRC-6.

TECHNICAL CHARACTERISTICS:

Frequency Range in Mc: 3.5 to 6.0 (any one of 50 channels)

Type Modulation: AM

Type of Signal: Voice

Power Output: 0.02 w

Power Requirements: 1.5 v dc from Battery BA-37; 103.5 v from Battery BA-38

MIL-HDBK-161

AN/PRC-type RADIO SET

MAJOR COMPONENTS

QTY	ITEM	STOCK NUMBERS	DIMENSIONS (Inches)	WEIGHT (Lbs)
		(USA)		
1	Radio Set SCR-536 (Equipment consists of only one major component.)	2S536		

REFERENCE DATA AND LITERATURE:

TM 11-235

SHIPPING DATA

PKGS	VOLUME (Cu Ft)	WEIGHT (Lbs)
1	0.6	17

PROCUREMENT DATA

PROCURING SERVICE: USA
SPEC &/or DWG: (USA) 71-1053

DESIGN COG: USA, Sig C

CONTRACTOR	LOCATION	CONTRACT OR ORDER NO.	APPROX UNIT COST
Electrical Research Laboratories, Inc.	Birmingham, Mich.	8259-P-45-01	\$67.98
Galvin Manufacturing Corp.	Philadelphia, Pa.	10531-P-45-01	64.48

RADIO SET AN/PRC-type

1 July 1958
 Cognizant Serv: USA FSN: 5820-223-2493

SCR-593-()

USA

USN

USAF

TYPE CLASS: L/Std
 STOCK NO: 2S593.1-V12

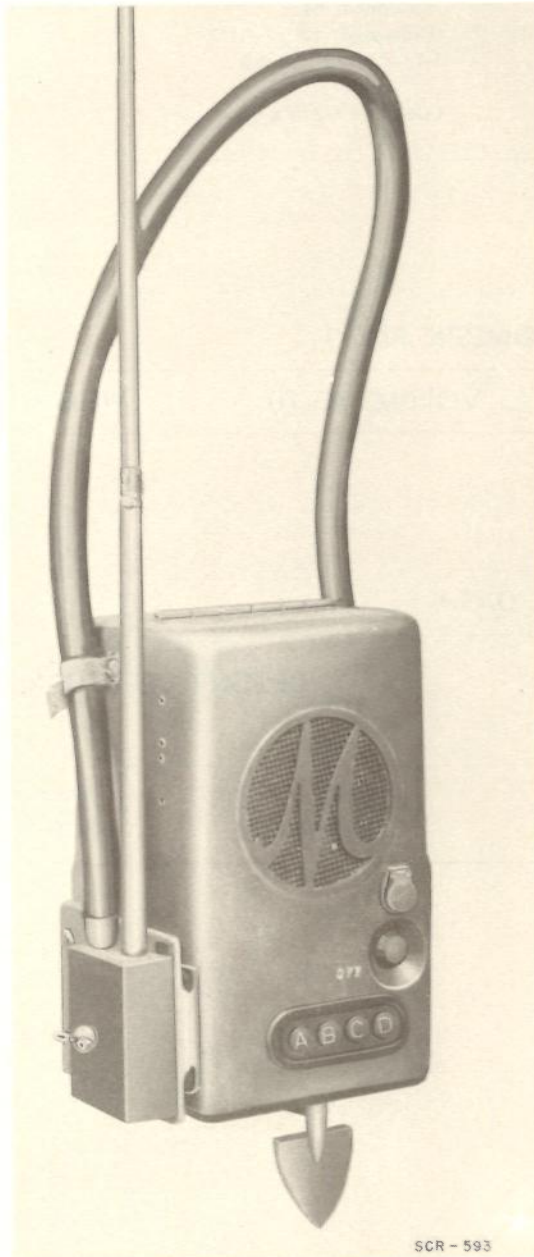
**FUNCTIONAL DESCRIPTION:**

Radio Set SCR-593-() is a portable, light weight, AM (voice), radio receiving equipment used for air-warning, patrols, and similar applications.

This equipment consists of a push-button controlled receiver that operates on four-preselected channels and has a rechargeable 2-volt battery. In portable applications, the telescoping antenna and associated lead-in, form a harness by which the set can be carried slung from the shoulder.

In vehicular applications, a shock mounting is provided.

TECHNICAL CHARACTERISTICS:

Frequency Range in Mc: 2 to 6

Type Modulation: AM

Type of Signal: Voice

Power Requirements: 2-v dc from Storage Battery BB-54-A.

MIL-HDBK-161

AN/PRC-type RADIO SET

MAJOR COMPONENTS

QTY	ITEM	STOCK NUMBERS	DIMENSIONS (Inches)	WEIGHT (Lbs)
		(USA)		
1	Antenna AN-75-A	2A275-75	(Extended) 84 (Collapsed) 12	4 4
1	Battery BB-54-A	3B54	5-7/32 x 3-27/32 x 3	4.77
1	Mounting FT-338-A	-----	-----	5.77
1	Radio Receiver BC-728-A	2C41728	11-9/16 x 8-3/8 x 5-5/8	15

REFERENCE DATA AND LITERATURE:

TM 11-859

SHIPPING DATA (DOMESTIC PACK)

PKGS	VOLUME (Cu Ft)	WEIGHT (Lbs)
1	3	63

PROCUREMENT DATA

PROCURING SERVICE: USA
SPEC &/or DWG: (USA) 71-1527

DESIGN COG: USA, Sig C

CONTRACTOR	LOCATION	CONTRACT OR ORDER NO.	APPROX UNIT COST
------------	----------	--------------------------	---------------------

RADIO SET **AN/PRC-type**

1 July 1958

Cognizant Serv: USA FSN: 5820-164-5831

SCR-609-()

USA

USN

USAF

TYPE CLASS: L/Std
 STOCK NO: 2S609

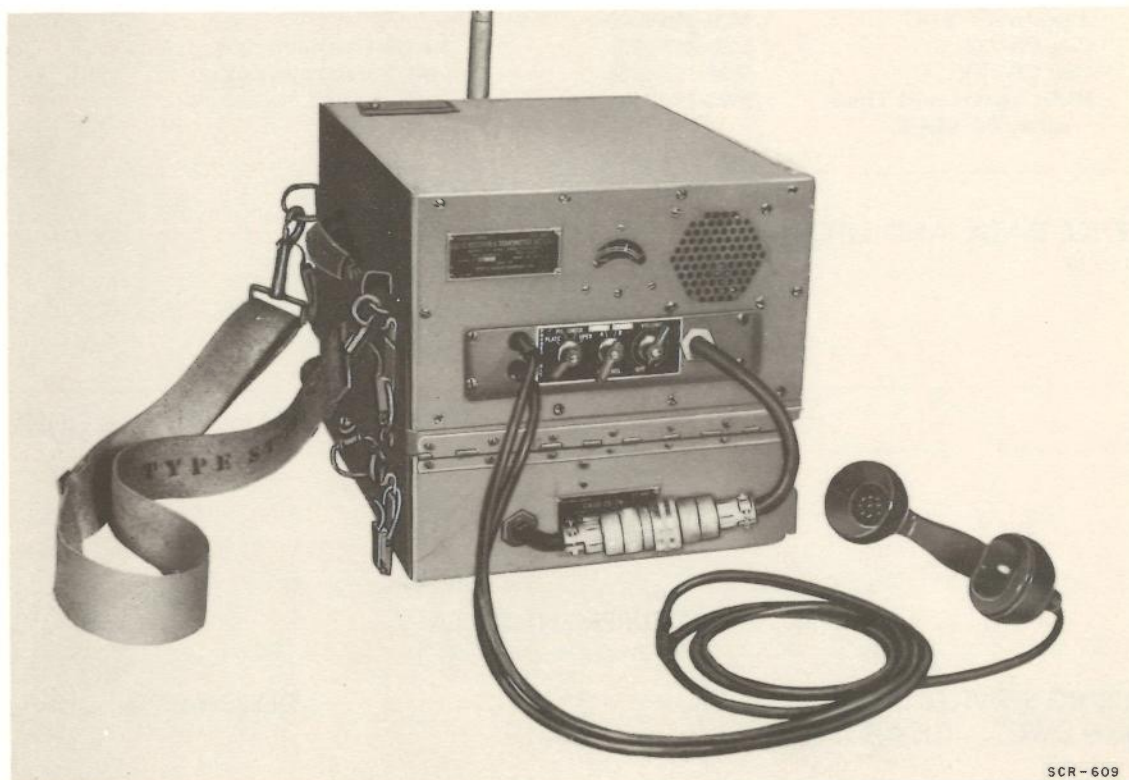

SCR-609

FUNCTIONAL DESCRIPTION:

Radio Set SCR-609-() is a transportable, low-power, short-range, FM (voice), transmitting and receiving equipment used by artillery units.

This equipment consists essentially of a receiver-transmitter component that derives its power from a set of dry batteries contained within a case to which it is attached by means of trunk-type clasps. Antenna, handset, and related accessories are included.

It provides 120 FM channels spaced 100 kc apart, two of which can be preset in the field. This set can be operated by means of standard remote control equipment.

Radio Set SCR-609 can be operated in a vehicle by means of a power-supply unit that derives its power from the storage

battery of the vehicle in which the equipment is installed. When so arranged the equipment is identical with Radio Set SCR-610 (AN/VRC-type).

TECHNICAL CHARACTERISTICS:

Frequency Range in Mc: 27.0 to 38.9

Type Modulation: FM

Type of Signal: Voice

Power Output: 1.3 w

Power Requirements:

Transmitting: Battery BA-39 and Battery BA-40

Receiving: Battery BA-40

Internal Bias: Battery BA-41

MIL-HDBK-161

AN/PRC-type RADIO SET

MAJOR COMPONENTS

QTY	ITEM	STOCK NUMBERS	DIMENSIONS (Inches)	WEIGHT (Lbs)
		(FSN)		
1	Antenna AN-29-C	5820-230-5445		2
1	Case CS-137	5955-497-9739	4-3/8 x 4-5/8 x 12-1/2	6.45
1	Case CS-79-()	5820-164-8784	6-1/2 x 15-1/4 x 18-1/4	14.94
1	Radio Receiver and Trans- mitter BC-659-J	5820-196-1715	11-7/8 x 16-3/8 x 21-1/2	35.13

REFERENCE DATA AND LITERATURE:

TM 11-615

SHIPPING DATA

PKGS	VOLUME (Cu Ft)	WEIGHT (Lbs)
2	7.4	137.5

PROCUREMENT DATA

PROCURING SERVICE: USA
SPEC &/or DWG: (USA)271-1318

DESIGN COG: USA, Sig C

CONTRACTOR	LOCATION	CONTRACT OR ORDER NO.	APPROX UNIT COST
------------	----------	--------------------------	---------------------

RADIO SET AN/PRC-type

1 July 1958

Cognizant Serv: USA FSN: 5820-192-7114

SCR-619

USA

USN

USAF

TYPE CLASS:

L/Std

--

--

STOCK NO:

2S619/6-12-24

--

--

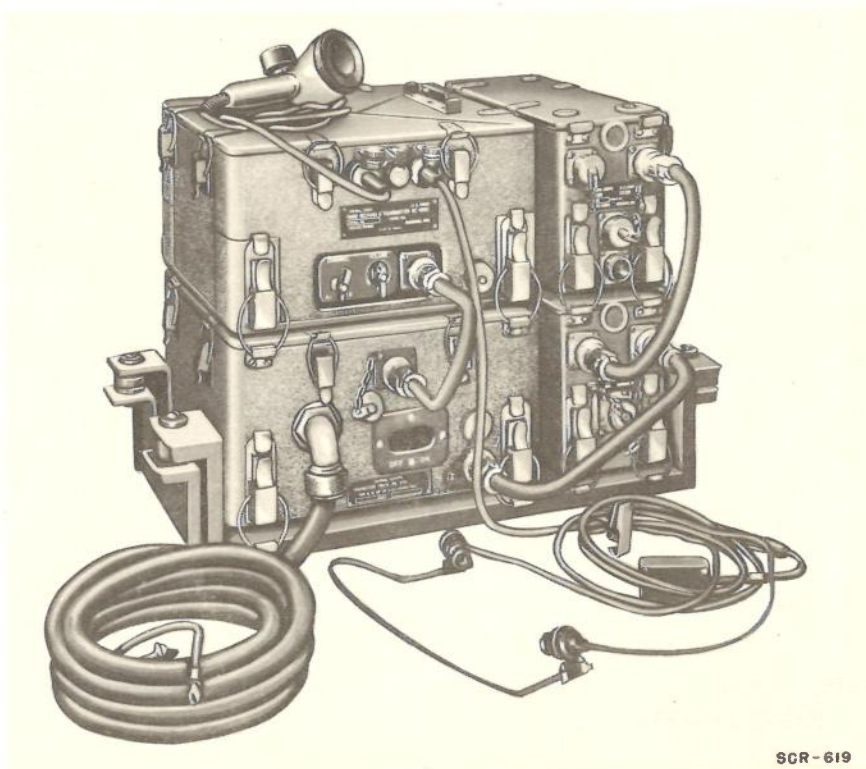

SCR-619

FUNCTIONAL DESCRIPTION:

Radio Set SCR-619 is a pack and vehicular, short-range, FM radiotelephone equipment used for communication in the VHF band by field artillery units in battery fire control applications.

This equipment consists of a crystal-controlled receiver-transmitter operating in 120 frequency channels spaced 100 kc apart, two of which are preset. A battery box, dynamotor, and battery charger are included.

This set uses a whip-type antenna and can be removed

from the vehicle in which it is installed for operation from the ground.

It is powered by the vehicular storage battery or by dry batteries contained in the battery box.

TECHNICAL CHARACTERISTICS:

Frequency Range in Mc: 27.0 to 38.9

Type Modulation: FM

Type of Signal: Voice

Power Output: 1.5 w

Power Requirements: 6 amp at 6-v dc; 3.5 amp at 12-v dc; or 24-v dc

MIL-HDBK-161

AN/PRC-type RADIO SET

MAJOR COMPONENTS

QTY	ITEM	STOCK NUMBERS	DIMENSIONS (Inches)	WEIGHT (Lbs)
		(FSN)		
1	Battery Box CY-740/PRC	6140-164-8787	5-3/4 x 10-1/4 x 11	9
1	Battery Charger PE-219	6130-222-6198	6-11/32 x 12-1/8 x 12-5/16	25
1	Mast Base MP-74	5985-221-5560	1-3/8 W x 14-1/8 L	.53
1	Mounting FT-506	5820-221-5511	10-3/16 x 4-11/16 x 21-3/16	12.25
1	Receiver-Transmitter BC-1335	5820-196-1708	6-21/32 x 12-1/2 x 13-9/32	22.75

REFERENCE DATA AND LITERATURE:

TM 11-619

SHIPPING DATA (DOMESTIC PACK)

PKGS	VOLUME (Cu Ft)	WEIGHT (Lbs)
3	16.1	366

PROCUREMENT DATA

PROCURING SERVICE: USA
SPEC &/or DWG: (USA) 71-3096

DESIGN COG: USA, Sig C

CONTRACTOR	LOCATION	CONTRACT OR ORDER NO.	APPROX UNIT COST
Rauland Corp.	Chicago, Ill.	2217-P-48	\$1,223.63

AN/PRC-type PORTABLE RADIO AND RECEIVING EQUIPMENT

Receiver:

EL Series Auxiliary Rectifier Power Equipment, 115-v
60-cycle 1-phase ac
EM Series Auxiliary Dynamotor Equipment, 6-v dc

EN Series Auxiliary Dynamotor Equipment, 12-v dc
EO Series Auxiliary Dynamotor Equipment, 24-v dc
EP Series Auxiliary Dynamotor Equipment, 32-v dc
EQ Series Auxiliary Dynamotor Equipment, 110-v dc

MAJOR COMPONENTS

QTY	ITEM	STOCK NUMBERS	DIMENSIONS (Inches)	WEIGHT (Lbs)
1	AC Motor Generator Equipment EG Series (Supplied by request)	-----	7-19/32 x 8-7/16 x 23-5/16	134.2
1	Antenna Assembly	-----		7.5
1	Auxiliary Dynamotor Equipment EM Series 6-v dc (May be supplied instead of dry battery)	-----	7-13/16 x 8-5/8 x 5-1/8	11.5
1	Auxiliary Dynamotor Equipment EM Series 12-v dc (May be supplied instead of dry battery)	-----	7-13/16 x 8-5/8 x 5-1/8	11.5
1	Auxiliary Dynamotor Equipment EO Series 24-v dc (May be supplied instead of dry battery)	-----	7-13/16 x 8-5/8 x 5-1/8	11.5
1	Auxiliary Dynamotor Equipment EP Series 32-v dc (May be supplied instead of dry battery)	-----	7-13/16 x 8-5/8 x 5-1/8	11.5
1	Auxiliary Dynamotor Equipment EQ Series 110-v dc (May be supplied instead of dry battery)	-----	7-13/16 x 8-5/8 x 5-1/8	11.5
1	Auxiliary Rectifier Power Equipment EL Series 115-v ac (May be supplied instead of dry battery)	-----	9-3/4 x 9-1/4 x 8-7/8	19
7	Batteries			
	(2) Type 19010	-----	4-5/16 x 2-5/8 x 2-5/8	
	(3) Type 19005	-----	6-5/8 x 2-11/16 x 4-1/4	
	(2) Type 19011	-----	2-13/16 x 7/8 x 4-1/16	
1	DC Motor Generator Equipment EH Series (Supplied by request)	-----	7-19/32 x 8-7/16 x 23-5/16	134.2
1	Dynamotor Equipment EJ Series (Supplied by request)	-----	6-13/16 x 9-1/4 x 7-21/32	20
1	Gasoline Engine-Driven Generator Equipment EF Series (Supplied by request)	-----		60.5
1	Generator, Hand- or Engine-Driven 21263A	-----	14-1/8 x 19-1/2 x 6-11/32	22.3
1	Shipping Chest for Complete Basic TBX 10017A	-----	17-3/4 x 49-3/4 x 18-3/8	82
1	Transmitter-Receiver Unit 43005	-----	8-1/2 x 15-53/64 x 10	29

PORTABLE RADIO AND RECEIVING EQUIPMENT AN/PRC-type

REFERENCE DATA AND LITERATURE:

SHIPPING DATA

PKGS	VOLUME (Cu Ft)	WEIGHT (Lbs)
1	17.7	355

PROCUREMENT DATA

PROCURING SERVICE: USN
SPEC &/or DWG:

DESIGN COG: USN, BuShips

CONTRACTOR	LOCATION	CONTRACT OR ORDER NO.	APPROX UNIT COST
General Electric Co.	Schenectady, N. Y.	TCG-34067, 25 Nov 1941 TCG-34107, 24 Nov 1941	\$1,100.00

PORTABLE RADIO AND RECEIVING EQUIPMENT **AN/PRC-type**

4 December 1958

Cognizant Serv: USN FSN:

TBX-1

	USA	USN	USAF
TYPE CLASS:	--	Used by	--
STOCK NO:	--	F16-Q-316996-200 (Navy)	--

(See Illustration TBX p. 1039)

FUNCTIONAL DESCRIPTION:

Portable Radio and Receiving Equipment TBX-1 may be used for ship or shore communication with similar equipment and other units of the Navy Communication system at ranges of approximately 30 miles for continuous-wave transmission and 15 miles for voice transmission.

The TBX series equipments are similar electrically and mechanically except that the TBX-5 through -8, and all the "a" equipments such as TBX-a, TBX-2a, etc, can operate at slightly higher frequencies.

The TBX series replaces the Radio Transmitting and Receiving Equipments TBO series.

TECHNICAL CHARACTERISTICS:*Transmitter:*

Frequency Range: 2,000 to 4,525 kc
 Frequency Control: Master oscillator and crystal
 Type of Signal: Cw, voice
 Power Output:
 Cw: 9 w
 Voice: 3 w

Receiver:

Frequency Range: 2,000 to 8,000 kc
 Frequency Control: Master oscillator and crystal

Type: Superheterodyne

Type of Signal: Cw, mcw, voice

Output Impedance: 600 ohms

Antenna Type: 7 section 24-foot vertical whip; or 30-foot single-wire L-type

Power Requirements:

Standard:

Transmitter: Hand-driven generator

Receiver: Battery pack

Optional:

Transmitter:

EF Series Gasoline Engine-Driven Generator Equipment

EG Series AC Motor Generator Equipment, 115-v 60-cycle 1-phase ac

EH Series DC Motor Generator Equipment, 115-v dc

EJ Series Dynamotor Equipment, 12-v dc

Receiver:

EL Series Auxiliary Rectifier Power Equipment, 115-v 60-cycle 1-phase ac

EM Series Auxiliary Dynamotor Equipment, 6-v dc

EN Series Auxiliary Dynamotor Equipment, 12-v dc

EO Series Auxiliary Dynamotor Equipment, 24-v dc

EP Series Auxiliary Dynamotor Equipment, 32-v dc

EQ Series Auxiliary Dynamotor Equipment, 110-v dc

MAJOR COMPONENTS

QTY	ITEM	STOCK NUMBERS	DIMENSIONS (Inches)	WEIGHT (Lbs)
1	AC Motor Generator Equipment EG Series (Supplied by request)	-----	7-19/32 x 8-7/16 x 23-5/16	134.2
1	Antenna assembly	-----		7.5
1	Auxiliary Dynamotor Equipment EM Series 6-v dc (May be supplied instead of dry battery)	-----	7-13/16 x 8-5/8 x 5-1/8	11.5
1	Auxiliary Dynamotor Equipment EM Series 12-v dc (May be supplied instead of dry battery)	-----	7-13/16 x 8-5/8 x 5-1/8	11.5

AN/PRC-type PORTABLE RADIO AND RECEIVING EQUIPMENT

MAJOR COMPONENTS—Continued

QTY	ITEM	STOCK NUMBERS	DIMENSION (Inches)	WEIGHT (Lbs)
1	Auxiliary Dynamotor Equipment EO Series 24-v dc (May be supplied instead of dry battery)	-----	7-13/16 x 8-5/8 x 5-1/8	11.5
1	Auxiliary Dynamotor Equipment EP Series 32-v dc (May be supplied instead of dry battery)	-----	7-13/16 x 8-5/8 x 5-1/8	11.5
1	Auxiliary Dynamotor Equipment EQ Series 110-v dc (May be supplied instead of dry battery)	-----	7-13/16 x 8-5/8 x 5-1/8	11.5
1	Auxiliary Rectifier Power Equipment EL Series 115-v ac (May be supplied instead of dry battery)	-----	9-3/4 x 9-1/4 x 8-7/8	19
7	Batteries			
	(2) Type 19010	-----	4-5/16 x 2-5/8 x 2-5/8	
	(3) Type 19005	-----	6-5/8 x 2-11/16 x 4-1/4	
	(2) Type 19011	-----	2-13/16 x 7/8 x 4-1/16	
1	DC Motor Generator Equipment EH Series (Supplied by request)	-----	7-19/32 x 8-7/16 x 23-5/16	134.2
1	Dynamotor Equipment EJ Series (Supplied by request)	-----	6-13/16 x 9-1/4 x 7-21/32	20
1	Gasoline Engine-Driven Generator EF Series (Supplied by request)	-----		60.5
1	Generator, Hand- or Engine-Driven 21263A	-----	14-1/8 x 19-1/2 x 6-11/32	22.3
1	Shipping Chest for Complete Basic TBX 10017A	-----	17-3/4 x 49-3/4 x 18-3/8	82
1	Transmitter-Receiver Unit 43005	-----	8-1/2 x 15-53/64 x 10	29

REFERENCE DATA AND LITERATURE:

SHIPPING DATA

PKGS	VOLUME (Cu Ft)	WEIGHT (Lbs)
1	17.7	355

PORTABLE RADIO AND RECEIVING EQUIPMENT **AN/PRC-type**

PROCUREMENT DATA

PROCURING SERVICE: USN
SPEC &/or DWG:

DESIGN COG: USN, BuShips

CONTRACTOR	LOCATION	CONTRACT OR ORDER NO.	APPROX UNIT COST
General Electric Co.	Schenectady, N. Y.	TCG-34067, 25 Nov 1941 TCG-34107, 24 Nov 1941 NOs-81118, 1 June 1942	\$1,100.00

PORTABLE RADIO AND RECEIVING EQUIPMENT **AN/PRC-type**

4 December 1958

Cognizant Serv: USN FSN:

TBX-2

USA

USN

USAF

TYPE CLASS: --

Used by

STOCK NO: --

F16-Q-317005-200

(See Illustration TBX p. 1039)

FUNCTIONAL DESCRIPTION:

Portable Radio and Receiving Equipment TBX-2 may be used for ship or shore communication with similar equipment and other units of the Navy communication system at ranges of approximately 30 miles for continuous-wave transmission and 15 miles for voice transmission.

The TBX series equipments are similar electrically and mechanically except that the TBX-5 through -8, and all the "a" equipments such as TBX-a, TBX-2a, etc., can operate at slightly higher frequencies.

The TBX series replaces the Radio Transmitting and Receiving Equipments TBO series.

TECHNICAL CHARACTERISTICS:*Transmitter:*

Frequency Range: 2,000 to 4,525 kc

Frequency Control: Master oscillator and crystal

Type of Signal: Cw, voice

Power Output:

Cw: 9 w

Voice: 3 w

Receiver:

Frequency Range: 2,000 to 8,000 kc

Frequency Control: Master oscillator and crystal

Type: Superheterodyne

Type of Signal: Cw, mcw, voice

Output Impedance: 600 ohms

Antenna Type: 7 section 24-foot vertical whip; or 30-foot single-wire L-type

Power Requirements:

Standard:

Transmitter: Hand-driven generator

Receiver: Battery pack

Optional:

Transmitter:

EF Series Gasoline Engine-Driven Generator Equipment

EG Series AC Motor Generator Equipment, 115-v 60-cycle 1-phase ac

EH Series DC Motor Generator Equipment, 115-v dc

EJ Series Dynamotor Equipment, 12-v dc

Receiver:

EL Series Auxiliary Rectifier Power Equipment, 115-v 60-cycle 1-phase ac

EM Series Auxiliary Dynamotor Equipment, 6-v dc

EN Series Auxiliary Dynamotor Equipment, 12-v dc

EO Series Auxiliary Dynamotor Equipment, 24-v dc

EP Series Auxiliary Dynamotor Equipment, 32-v dc

EQ Series Auxiliary Dynamotor Equipment, 110-v dc

MAJOR COMPONENTS

QTY	ITEM	STOCK NUMBERS	DIMENSIONS (Inches)	WEIGHT (Lbs)
1	AC Motor Generator Equipment EG Series (Supplied by request)	-----	7-19/32 x 8-7/16 x 23-5/16	134.2
1	Antenna Assembly	-----		7.5
1	Auxiliary Dynamotor Equipment EM Series 6-v dc (May be supplied instead of dry battery)	-----	7-13/16 x 8-5/8 x 5-1/8	11.5
1	Auxiliary Dynamotor Equipment EM Series 12-v dc (May be supplied instead of dry battery)	-----	7-13/16 x 8-5/8 x 5-1/8	11.5

AN/PRC-type PORTABLE RADIO AND RECEIVING EQUIPMENT

MAJOR COMPONENTS—Continued

QTY	ITEM	STOCK NUMBERS	DIMENSIONS (Inches)	WEIGHT (Lbs)
1	Auxiliary Dynamotor Equipment EO Series 24-v dc (May be supplied instead of dry battery)	-----	7-13/16 x 8-5/8 x 5-1/8	11.5
1	Auxiliary Dynamotor Equipment EP Series 32-v dc (May be supplied instead of dry battery)	-----	7-13/16 x 8-5/8 x 5-1/8	11.5
1	Auxiliary Dynamotor Equipment EQ Series 110-v dc (May be supplied instead of dry battery)	-----	7-13/16 x 8-5/8 x 5-1/8	11.5
1	Auxiliary Rectifier Power Equipment EL Series 115-v ac (May be supplied instead of dry battery)	-----	9-3/4 x 9-1/4 x 8-7/8	19
7	Batteries			
	(2) Type 19010	-----	4-5/16 x 2-5/8 x 2-5/8	
	(3) Type 19005	-----	6-5/8 x 2-11/16 x 4-1/4	
	(2) Type 19011	-----	2-13/16 x 7/8 x 4-1/16	
1	DC Motor Generator Equipment EH Series (Supplied by request)	-----	7-19/32 x 8-7/16 x 23-5/16	134.2
1	Dynamotor Equipment EJ Series (Supplied by request)	-----	6-13/16 x 9-1/4 x 7-21/32	20
1	Gasoline Engine-Driven Generator Equipment EF Series (Supplied by request)	-----		60.5
1	Generator, Hand- or Engine-Driven 21263A	-----	14-1/8 x 19-1/2 x 6-11/32	22.3
1	Shipping Chest for Complete Basic TBX 10017A	-----	17-3/4 x 49-3/4 x 18-3/8	82
1	Transmitter-Receiver Unit 43005	-----	8-1/2 x 15-53/64 x 10	69

REFERENCE DATA AND LITERATURE:

SHIPPING DATA

PKGS	VOLUME (Cu Ft)	WEIGHT (Lbs)
1	17.7	355

PORTABLE RADIO AND RECEIVING EQUIPMENT **AN/PRC-type**

PROCUREMENT DATA

PROCURING SERVICE: USN
SPEC &/or DWG:

DESIGN COG: USN, BuShips

CONTRACTOR	LOCATION	CONTRACT OR ORDER NO.	APPROX UNIT COST
General Electric Co.	Schenectady, N. Y.	TCG-34067, 25 Nov 1941 TCG-34107 24 Nov 1941 NOs-81118, 1 June 1942	\$1,100.00

PORTABLE RADIO AND RECEIVING EQUIPMENT AN/PRC-type

4 December 1958

Cognizant Serv: USN FSN:

TBX-3

	USA	USN	USAF
TYPE CLASS:	--	Used by	--
STOCK NO:	--	--	--

(See Illustration: TBX p. 1039)

FUNCTIONAL DESCRIPTION:

Portable Radio and Receiving Equipment TBX-3 may be used for ship or shore communication with similar equipment and other units of the Navy Communication system at ranges of approximately 30 miles for cw transmission and 15 miles for voice transmission.

The TBX series equipments are similar electrically and mechanically except that the TBX-5 through -8, and all the "a" equipments such as TBX-a, TBX-2a, etc., can operate at slightly higher frequencies.

The TBX series replaces the Radio Transmitting and Receiving Equipments TBO series.

TECHNICAL CHARACTERISTICS:*Transmitter:*

Frequency Range: 2,000 to 4,525 kc

Frequency Control: Master oscillator and crystal

Type of Signal: Cw, voice

Power Output:

Cw: 9 w

Voice: 3 w

Receiver:

Frequency Range: 2,000 to 8,000 kc

Type: Superheterodyne

Type of Signal: Cw, mcw, voice

Control: Master oscillator and crystal

Output Impedance: 600 ohms

Antenna Type: 7 section 24-foot vertical whip;*Power Requirements:**Standard:*

Transmitter: Hand-driven generator

Receiver: Battery pack

*Optional:**Transmitter:*

EF Series Gasoline Engine-Driven Generator Equipment

EG Series AC Motor Generator Equipment, 115-v 60-cycle 1-phase ac

EH Series DC Motor Generator Equipment, 115-v dc

EJ Series Dynamotor Equipment, 12-v dc

Receiver:

EL Series Auxiliary Rectifier Power Equipment, 115-v 60-cycle 1-phase ac

EM Series Auxiliary Dynamotor Equipment, 6-v dc

EN Series Auxiliary Dynamotor Equipment, 12-v dc

EO Series Auxiliary Dynamotor Equipment, 24-v dc

EP Series Auxiliary Dynamotor Equipment, 32-v dc

EQ Series Auxiliary Dynamotor Equipment, 110-v dc

MAJOR COMPONENTS

QTY	ITEM	STOCK NUMBERS	DIMENSIONS (Inches)	WEIGHT (Lbs)
1	AC Motor Generator Equipment EG Series (Supplied by request)	-----	7-19/32 x 8-7/16 x 23-5/16	134.2
1	Antenna Assembly	-----		7.5
1	Auxiliary Dynamotor Equipment EM Series 6-v dc (May be supplied instead of dry battery)	-----	7-13/16 x 8-5/8 x 5-1/8	11.5
1	Auxiliary Dynamotor Equipment EM Series 12-v dc (May be supplied instead of dry battery)	-----	7-13/16 x 8-5/8 x 5-1/8	11.5

AN/PRC-type PORTABLE RADIO AND RECEIVING EQUIPMENT

MAJOR COMPONENTS—Continued

QTY	ITEM	STOCK NUMBERS	DIMENSIONS (Inches)	WEIGHT (Lbs)
1	Auxiliary Dynamotor Equipment EO Series 24-v dc (May be supplied instead of dry battery)	-----	7-13/16 x 8-5/8 x 5-1/8	11.5
1	Auxiliary Dynamotor Equipment EP Series 32-v dc (May be supplied instead of dry battery)	-----	7-13/16 x 8-5/8 x 5-1/8	11.5
1	Auxiliary Rectifier Power Equipment EL Series 115-v ac (May be supplied instead of dry battery)	-----	9-3/4 x 9-1/4 x 8-7/8	19
7	Batteries:			
	(2) Type 19010	-----	4-5/16 x 2-5/8 x 2-5/8	
	(3) Type 19005	-----	6-5/8 x 2-11/16 x 4-1/4	
	(2) Type 19011	-----	2-13/16 x 7/8 x 4-1/16	
1	DC Motor Generator Equipment EH Series (Supplied by request)	-----	7-19/32 x 8-7/16 x 23-5/16	134.2
1	Dynamotor Equipment EJ Series (Supplied by request)	-----	6-13/16 x 9-1/4 x 7-21/32	20
1	Gasoline Engine-Driven Generator Equipment EF Series (Supplied by request)	-----		60.5
1	Generator, Hand- or Engine-Driven 21263A	-----	14-1/8 x 19-1/2 x 6-11/32	22.3
1	Shipping Chest for Complete Basic TBX 10017A	-----	17-3/4 x 49-3/4 x 18-3/8	82
1	Transmitter-Receiver Unit 43005	-----	8-1/2 x 15-53/64 x 10	29

REFERENCE DATA AND LITERATURE:

SHIPPING DATA

PKGS	VOLUME (Cu Ft)	WEIGHT (Lbs)
1	17.7	355

PORTABLE RADIO AND RECEIVING EQUIPMENT **AN/PRC-type**

PROCUREMENT DATA

PROCURING SERVICE: USN
SPEC &/or DWG:

DESIGN COG: USN, BuShips

CONTRACTOR	LOCATION	CONTRACT OR ORDER NO.	APPROX UNIT COST
General Electric Co.	Schenectady, N. Y.	TCG-34067, 25 Nov 1941 TCG-34107, 24 Nov 1941 NOs-81118, 1 Jun 1942	\$1,100.00

PORTABLE RADIO AND RECEIVING EQUIPMENT **AN/PRC-type**

4 December 1958

Cognizant Serv: USN FSN:

TBX-4

	USA	USN	USAF
TYPE CLASS:	--	Used by	--
STOCK NO:	--	(6-v dc) F16-Q-317045- 200	--

(See Illustration: TBX p. 1039)

FUNCTIONAL DESCRIPTION:

Portable Radio and Receiving Equipment TBX-4 may be used for ship or shore communication with similar equipment and other units of the Navy Communication system at ranges of approximately 30 miles for cw transmission and 15 miles for voice transmission.

The TBX series equipments are similar electrically and mechanically except that the TBX-5 through -8, and all the "a" equipments such as TBX-a, TBX-2a, etc., can operate at slightly higher frequencies.

The TBX series replaces the Radio Transmitting and Receiving Equipments TBO series.

TECHNICAL CHARACTERISTICS:*Transmitter:*

Frequency Range: 2,000 to 4,525 kc
 Frequency Control: Master oscillator and crystal
 Type of Signal: Cw, voice
 Power Output:
 Cw: 9 w
 Voice: 3 w

Receiver:

Frequency Range: 2,000 to 8,000 kc
 Frequency Control: Master oscillator and crystal

Type: Superheterodyne

Type of Signal: Cw, mcw, voice

Output Impedance: 600 ohms

Antenna Type: 7 section 24-foot vertical whip; or 30-foot single-wire L-type

Power Requirements:

Standard:

Transmitter: Hand-driven generator

Receiver: Battery pack

Optional:

Transmitter:

EF Series Gasoline Engine-Driven Generator Equipment

EG Series AC Motor Generator Equipment, 115-v 60-cycle 1-phase ac

EH Series DC Motor Generator Equipment, 115-v dc

EJ Series Dynamotor Equipment, 12-v dc

Receiver:

EL Series Auxiliary Rectifier Power Equipment, 115-v 60-cycle 1-phase ac

EM Series Auxiliary Dynamotor Equipment, 6-v dc

EN Series Auxiliary Dynamotor Equipment, 12-v dc

EO Series Auxiliary Dynamotor Equipment, 24-v dc

EP Series Auxiliary Dynamotor Equipment, 32-v dc

EQ Series Auxiliary Dynamotor Equipment, 110-v dc

MAJOR COMPONENTS

QTY	ITEM	STOCK NUMBERS	DIMENSIONS (Inches)	WEIGHT (Lbs)
1	AC Motor Generator Equipment EG Series (Supplied by request)	-----	7-19/32 x 8-7/16 x 23-5/16	134.2
1	Antenna Assembly	-----	-----	7.5
1	Auxiliary Dynamotor Equipment EM Series 6-v dc	-----	7-13/16 x 8-5/8 x 5-1/8	11.5
1	Auxiliary Dynamotor Equipment EM Series 12-v dc	-----	7-13/16 x 8-5/8 x 5-1/8	11.5
1	Auxiliary Dynamotor Equipment EO Series 24-v dc	-----	7-13/16 x 8-5/8 x 5-1/8	11.5
1	Auxiliary Dynamotor Equipment EP Series 32-v dc	-----	7-13/16 x 8-5/8 x 5-1/8	11.5
1	Auxiliary Dynamotor Equipment EQ Series 110-v dc	-----	7-13/16 x 8-5/8 x 5-1/8	11.5

AN/PRC-type PORTABLE RADIO AND RECEIVING EQUIPMENT

MAJOR COMPONENTS—Continued

QTY	ITEM	STOCK NUMBERS	DIMENSIONS (Inches)	WEIGHT (Lbs)
1	Auxiliary Rectifier Power Equipment EL Series 115-v ac	-----	9-3/4 x 9-1/4 x 8-7/8	19.
7	Batteries (2) Type 19010 (3) Type 19005 (2) Type 19011	----- ----- -----	6-5/16 x 2-5/8 x 2-5/8 6-5/8 x 2-11/16 x 4-1/4 2-13/16 x 7/8 x 4-1/16	
1	DC Motor Generator Equip- ment EH Series (Supplied by request)	-----	7-19/32 x 8-7/16 x 23-5/16	134.2
1	Dynamotor Equipment EJ Series (Supplied by request)	-----	6-13/16 x 9-1/4 x 7-21/32	20
1	Gasoline Engine-Driven Gen- erator Equipment EF Series (Supplied by request)	-----		60.5
1	Generator, Hand- or Engine- Driven 21263A	-----	14-1/8 x 19-1/2 x 6-11/32	22.3
1	Shipping Chest for Complete Basic TBX 10017A	-----	17-3/4 x 49-3/4 x 18-3/8	82
1	Transmitter-Receiver Unit 43005A	-----	8-1/2 x 15-53/64 x 10	29

REFERENCE DATA AND LITERATURE:

NAVSHIPS 95618

SHIPPING DATA

PGKS	VOLUME (Cu Ft)	WEIGHT (Lb)
1	17.7	355

PROCUREMENT DATA

PROCURING SERVICE: USN
SPEC &/or DWG:

DESIGN COG: USN, BuShips

CONTRACTOR	LOCATION	CONTRACT OR ORDER NO.	APPROX UNIT COST
Hazeltine Electronics Corp.	New York, N. Y.	NXss-18179, 19 Nov 1942	\$1,100.00

PORTABLE RADIO AND RECEIVING EQUIPMENT **AN/PRC-type**

4 December 1958

Cognizant Serv: USN FSN:

TBX-4A

USA

USN

USAF

TYPE CLASS: --

Used by

STOCK NO: --

F16-Q-317065-200

(See Illustration: TBX p. 1039)

FUNCTIONAL DESCRIPTION:

Portable Radio and Receiving Equipment TBX-4a may be used for ship or shore communication with similar equipment and other units of the Navy Communication system at ranges of approximately 30 miles for cw transmission and 15 miles for voice transmission.

The TBX series equipments are similar electrically and mechanically except that the TBX-5 through -8, and all the "a" equipments such as this equipment, can operate at slightly higher frequencies.

The TBX series replaces the Radio Transmitting and Receiving Equipments TBO series.

TECHNICAL CHARACTERISTICS:*Transmitter:*

Frequency Range: 2,000 to 5,800 kc

Frequency Control: Master oscillator and crystal

Type of Signal: Cw, voice

Power Output:

Cw: 9 w

Voice: 3 w

Receiver:

Frequency Range: 2,000 to 8,000 kc

Frequency Control: Master oscillator and crystal

Type: Superheterodyne

Type of Signal: Cw, mcw, voice

Output Impedance: 600 ohms

Type Antenna: 7 section 24-foot vertical whip; or 30-foot single-wire L-type

Power Requirements:

Standard:

Transmitter: Hand-driven generator

Receiver: Battery pack

Optional:

Transmitter:

EF Series Gasoline Engine-Driven Generator Equipment

EG Series AC Motor Generator Equipment, 115-v 60-cycle 1-phase ac

EH Series DC Motor Generator Equipment, 115-v dc

EJ Series Dynamotor Equipment, 12-v dc

Receiver:

EL Series Auxiliary Rectifier Power Equipment, 115-v 60-cycle 1-phase ac

EM Series Auxiliary Dynamotor Equipment, 6-v dc

EN Series Auxiliary Dynamotor Equipment, 12-v dc

EO Series Auxiliary Dynamotor Equipment, 24-v dc

EP Series Auxiliary Dynamotor Equipment, 32-v dc

EQ Series Auxiliary Dynamotor Equipment, 110-v dc

MAJOR COMPONENTS

QTY	ITEM	STOCK NUMBERS	DIMENSION (Inches)	WEIGHT (Lbs)
1	AC Motor Generator Equipment EG Series (Supplied by request)	-----	7-19/32 x 8-7/16 x 23-5/16	134.2
1	Antenna Assembly	-----	-----	7.5
1	Auxiliary Dynamotor Equipment EM Series 6-v dc (May be supplied instead of dry battery)	-----	7-13/16 x 8-5/8 x 5-1/8	11.5
1	Auxiliary Dynamotor Equipment EM Series 12-v dc (May be supplied instead of dry battery)	-----	7-13/16 x 8-5/8 x 5-1/8	11.5

AN/PRC-type PORTABLE RADIO AND RECEIVING EQUIPMENT

MAJOR COMPONENTS—Continued

QTY	ITEM	STOCK NUMBERS	DIMENSIONS (Inches)	WEIGHT (Lbs)
1	Auxiliary Dynamotor Equip- ment EO Series 24-v dc (May be supplied instead of dry battery)	-----	7-13/16 x 8-5/8 x 5-1/8	11.5
1	Auxiliary Dynamotor Equip- ment EO Series 110-v dc (May be supplied instead of dry battery)	-----	7-13/16 x 8 1/8 x 5-1/8	11.5
1	Auxiliary Dynamotor Equip- ment EP Series 32-v dc (May be supplied instead of dry battery)	-----	7-13/16 x 8-5/8 x 5-1/8	11.5
1	Auxiliary Rectifier Power Equipment EL Series 115-v ac (May be supplied instead of dry battery)	-----	9-3/4 x 9-1/4 x 8-7/8	19
7	Batteries:			
	(2) Type 19010	-----	4-5/16 x 2-5/8 x 2-5/8	
	(3) Type 19005	-----	6-5/8 x 2-11/16 x 4-1/4	
	(2) Type 19011	-----	2-13/16 x 7/8 x 4-1/16	
1	DC Motor Generator Equip- ment EH Series (Supplied by request)	-----	7-19/32 x 8-7/16 x 23-5/16	134.2
1	Dynamotor Equipment EJ Series (Supplied by request)	-----	6-13/16 x 9-1/4 x 7-21/32	20
1	Gasoline Engine-Driven Gen- erator Equipment EF Series (Supplied by request)	-----	-----	60.5
1	Generator, Hand- or Engine- Driven 21263A	-----	14-1/8 x 19-1/2 x 6-11/32	22.3
1	Shipping Chest for Complete Basic TBX 10017A	-----	17-3/4 x 49-3/4 x 18-3/8	82
1	Transmitter-Receiver Unit 43005D	-----	8-1/2 x 15-53/64 x 10	29

REFERENCE DATA AND LITERATURE:

SHIPPING DATA

PKGS	VOLUME (Cu Ft)	WEIGHT (Lbs)
1	17.7	355

PORTABLE RADIO AND RECEIVING EQUIPMENT AN/PRC-type

PROCUREMENT DATA

PROCURING SERVICE: USN
SPEC &/or DWG:**DESIGN COG:** USN, BuShips

CONTRACTOR	LOCATION	CONTRACT OR ORDER NO.	APPROX UNIT COST
Hazeltine Electronics Corp.	New York, N. Y.	NXss-18179, 19 Nov 1942	\$1,100.00

PORTABLE RADIO AND RECEIVING EQUIPMENT AN/PRC-type

4 December 1958

Cognizant Serv: USN FSN:

TBX-5

USA

USN

USAF

TYPE CLASS: --

Used by

STOCK NO: --

F16-Q-317070-200

(See Illustration: TBX p. 1039)

FUNCTIONAL DESCRIPTION:

Portable Radio and Receiving Equipment TBX-5 may be used for ship or shore communication with similar equipment and other units of the Navy Communication system at ranges of approximately 30 miles for cw transmission and 15 miles for voice transmission.

The TBX series equipments are similar electrically and mechanically except that the TBX-7 through -8, and all the "a" equipments such as TBX-a, TBX-2a, etc., can operate at slightly higher frequencies.

The TBX series replaces the Radio Transmitting and Receiving Equipments TBO series.

TECHNICAL CHARACTERISTICS:

Transmitter:

Frequency Range: 2,000 to 5,800 kc
Control: Master oscillator and crystal
Type of Signal: Cw, voice
Power Output:
Cw: 9 w
Voice: 3 w

Receiver:

Frequency Range: 2,000 to 8,000 kc
Frequency Control: Master oscillator and crystal

Type: Superheterodyne

Type of Signal: Cw, mcw, voice

Output Impedance: 600 ohms

Type Antenna: 7 section 24-foot vertical whip; or 30-foot single-wire L-type

Power Requirements:

Standard:

Transmitter: Hand-driven generator*Receiver:* Battery pack

Optional:

Transmitter:

EF Series Gasoline Engine-Driven Generator Equipment

EG Series AC Motor Generator Equipment, 115-v 60-cycle 1-phase ac

EH Series DC Motor Generator Equipment, 115-v dc

EJ Series Dynamotor Equipment, 12-v dc

Receiver:

EL Series Auxiliary Rectifier Power Equipment, 115-v 60-cycle 1-phase ac

EM Series Auxiliary Dynamotor Equipment, 6-v dc

EN Series Auxiliary Dynamotor Equipment, 12-v dc

EO Series Auxiliary Dynamotor Equipment, 24-v dc

EP Series Auxiliary Dynamotor Equipment, 32-v dc

EQ Series Auxiliary Dynamotor Equipment, 110-v dc

MAJOR COMPONENTS

QTY	ITEM	STOCK NUMBERS	DIMENSIONS (Inches)	WEIGHT (Lbs)
1	AC Motor Generator Equipment EG Series (Supplied by request)	-----	7-19/32 x 8-7/16 x 23-5/16	134.2
1	Antenna Assembly	-----		7.5
1	Auxiliary Dynamotor Equipment EM Series 6-v dc (May be supplied instead of dry battery)	-----	7-13/16 x 8-5/8 x 5-1/8	11.5
1	Auxiliary Dynamotor Equipment EM Series 12-v dc (May be supplied instead of dry battery)	-----	7-13/16 x 8-5/8 x 5-1/8	11.5

AN/PRC-type PORTABLE RADIO AND RECEIVING EQUIPMENT

MAJOR COMPONENTS—Continued

QTY	ITEM	STOCK NUMBERS	DIMENSIONS (Inches)	WEIGHT (Lbs)
1	Auxiliary Dynamotor Equipment EO Series 24-v dc (May be supplied instead of dry battery)	-----	7-13/16 x 8-5/8 x 5-1/8	11.5
1	Auxiliary Dynamotor Equipment EP Series 32-v dc (May be supplied instead of dry battery)	-----	7-13/16 x 8-5/8 x 5-1/8	11.5
1	Auxiliary Dynamotor Equipment EO Series 110-v dc (May be supplied instead of dry battery)	-----	7-13/16 x 8-5/8 x 5-1/8	11.5
1	Auxiliary Rectifier Power Equipment EL Series 115-v ac (May be supplied instead of dry battery)	-----	9-3/5 x 9-1/4 x 8-7/8	19
7	Batteries			
	(2) Type 19010	-----	4-5/16 x 2-5/8 x 2-5/8	
	(3) Type 19005	-----	6-5/8 x 2-11/16 x 4-1/4	
	(2) Type 19011	-----	2-13/16 x 7/8 x 4-1/16	
1	DC Motor Generator Equipment EH Series (Supplied by request)	-----	7-19/32 x 8-7/16 x 23-5/16	134.2
1	Dynamotor Equipment EJ Series (Supplied by request)	-----	6-13/16 x 9-1/4 x 7-21/32	20
1	Gasoline Engine-Driven Generator Equipment EF Series (Supplied by request)	-----		60.5
1	Generator, Hand- or Engine-Driven 21263A	-----	14-1/8 x 19-1/2 x 6-11/32	22.3
1	Shipping Chest for Complete Basic TBX 10017A	-----	17-3/4 x 49-3/4 x 18-3/8	82
1	Transmitter-Receiver Unit 43005D	-----	8-1/2 x 15-53/64 x 10	29

REFERENCE DATA AND LITERATURE:

NAVSHIPS 95297

SHIPPING DATA

PKGS	VOLUME (Cu Ft)	WEIGHT (Lbs)
1	17.7	355

PORTABLE RADIO AND RECEIVING EQUIPMENT **AN/PRC-type**

PROCUREMENT DATA

PROCURING SERVICE: USN
SPEC &/or DWG:

DESIGN COG: USN, BuShips

CONTRACTOR	LOCATION	CONTRACT OR ORDER NO.	APPROX UNIT COST
Garad Radio Corp.	Brooklyn, N. Y.	NXss-31870, 28 Jun 1943	\$1,100.00

PORTABLE RADIO AND RECEIVING EQUIPMENT **AN/PRC-type**

4 December 1958

Cognizant Serv: USN FSN:

TBX-6

USA

USN

USAF

TYPE CLASS: --
STOCK NO: --Used by
12-v dc: F16-Q-317105- --
200
32-v dc: F16-Q-317165-
200

(See Illustration: TBX p. 1039)

FUNCTIONAL DESCRIPTION:

Portable Radio and Receiving Equipment TBX-6 may be used for ship or shore communication with similar equipment and other units of the Navy Communication system at ranges of approximately 30 miles for cw transmission and 15 miles for voice transmission.

The TBX series equipments are similar electrically and mechanically except that the TBX-5 through -8, and all the "a" equipments such as TBX-a, TBX-2a, etc., can operate at slightly higher frequencies.

The TBX series replaces the Radio Transmitting and Receiving Equipments TBO series.

TECHNICAL CHARACTERISTICS:*Transmitter:*

Frequency Range: 2,000 to 5,800 kc
Frequency Control: Master oscillator and crystal
Type of Signal: Cw, voice
Power Output:
Cw: 9 w
Voice: 3 w

Receiver:

Frequency Range: 2,000 to 8,000 kc
Frequency Control: Master oscillator and crystal
Type: Superheterodyne

Type of Signal: Cw, mcw, voice

Output Impedance: 600 ohms

Antenna Type: 7 section 24-foot vertical whip; or 30-foot single-wire L-type

Power Requirements:

Standard:

Transmitter: Hand-driven generator

Receiver: Battery pack

Optional:

Transmitter:

EF Series Gasoline Engine-Driven Generator Equipment

EG Series AC Motor Generator Equipment, 115-v 60-cycle 1-phase ac

EH Series DC Motor Generator Equipment, 115-v dc

EJ Series Dynamotor Equipment, 12-v dc

Receiver:

EL Series Auxiliary Rectifier Power Equipment, 115-v 60-cycle 1-phase ac

EM Series Auxiliary Dynamotor Equipment, 6-v dc

EN Series Auxiliary Dynamotor Equipment, 12-v dc

EO Series Auxiliary Dynamotor Equipment, 24-v dc

EP Series Auxiliary Dynamotor Equipment, 32-v dc

EQ Series Auxiliary Dynamotor Equipment, 110-v dc

MAJOR COMPONENTS

QTY	ITEM	STOCK NUMBERS	DIMENSIONS (Inches)	WEIGHT (Lbs)
1	AC Motor Generator Equipment EG Series (Supplied by request)	-----	7-19/32 x 8-7/16 x 23-5/16	134.2
1	Antenna Assembly	-----		7.5
1	Auxiliary Dynamotor Equipment EM Series 6-v dc (May be supplied instead of dry battery)	-----	7-13/16 x 8-5/8 x 5-1/8	11.5

AN/PRC-type PORTABLE RADIO AND RECEIVING EQUIPMENT

MAJOR COMPONENTS—Continued

QTY	ITEM	STOCK NUMBERS	DIMENSIONS (Inches)	WEIGHT (Lbs)
1	Auxiliary Dynamotor Equipment EM Series 12-v dc (May be supplied instead of dry battery)	-----	7-13/16 x 8-5/8 x 5-1/8	11.5
1	Auxiliary Dynamotor Equipment EO Series 24-v dc (May be supplied instead of dry battery)	-----	7-13/16 x 8-5/8 x 5-1/8	11.5
1	Auxiliary Dynamotor Equipment EP Series 32-v dc (May be supplied instead of dry battery)	-----	7-13/16 x 8-5/8 x 5-1/8	11.5
1	Auxiliary Dynamotor Equipment EQ Series 110-v dc (May be supplied instead of dry battery)	-----	7-13/16 x 8-5/8 x 5-1/8	11.5
1	Auxiliary Rectifier Power Equipment EL Series 115-v ac (May be supplied instead of dry battery)	-----	9-3/4 x 9-1/4 x 8-7/8	19
7	Batteries			
	(2) Type 19010	-----	4-5/16 x 2-5/8 x 2-5/8	
	(3) Type 19005	-----	6-5/8 x 2-11/16 x 4-1/4	
	(2) Type 19011	-----	2-13/16 x 7/8 x 4-1/16	
1	DC Motor Generator Equipment EH Series (Supplied by request)	-----	7-19/32 x 8-7/16 x 23-5/16	134.2
1	Dynamotor Equipment EJ Series (Supplied by request)	-----	6-13/16 x 9-1/4 x 7-21/32	20
1	Gasoline Engine-Driven Generator Equipment EF Series (Supplied by request)	-----	-----	60.5
1	Generator, Hand- or Engine-Driven 21263A	-----	14-1/8 x 19-1/2 x 6-11/32	22.3
1	Shipping Chest for Complete Basic TBX 10017A	-----	17-3/4 x 49-3/4 x 18-3/8	82
1	Transmitter-Receiver Unit 43005C	-----	8-1/2 x 15-53/64 x 10	29

REFERENCE DATA AND LITERATURE:

NAVSHIPS 95298

PORTABLE RADIO AND RECEIVING EQUIPMENT AN/PRC-type

SHIPPING DATA

PKGS	VOLUME (Cu Ft)	WEIGHT (Lbs)
1	17.7	355

PROCUREMENT DATA

PROCURING SERVICE: **USN**
SPEC &/or DWG:

DESIGN COG: **USN, BuShips**

CONTRACTOR	LOCATION	CONTRACT OR ORDER NO.	APPROX UNIT COST
General Electric Co.	Schenectady, N. Y.	NXsr-35352, 30 Jul 1943	\$1,100.00

PORTABLE RADIO AND RECEIVING EQUIPMENT **AN/PRC-type**

4 December 1958

Cognizant Serv: **USN** **FSN:****TBX-7**

	USA	USN	USAF
TYPE CLASS:	--	Used by	--
STOCK NO:	--	--	--

(See Illustration: TBX p. 1039)

FUNCTIONAL DESCRIPTION:

Portable Radio and Receiving Equipment TBX-7 may be used for ship or shore communication with similar equipment and other units of the Navy Communication system at ranges of approximately 30 miles for cw transmission and 15 miles for voice transmission.

The TBX series equipments are similar electrically and mechanically except that the TBX-5 through -8, and all the "a" equipments such TBX-a, TBX-2a, etc., can operate at slightly higher frequencies.

The TBX series replaces the Radio Transmitting and Receiving Equipments TBO series.

TECHNICAL CHARACTERISTICS:*Transmitter:*

Frequency Range: 2,000 to 5,800 kc

Frequency Control: Master oscillator and crystal

Type of Signal: Cw, voice

Power Output:

Cw: 9 w

Voice: 3 w

Receiver:

Frequency Range: 2,000 to 8,000 kc

Frequency Control: Master oscillator and crystal

Type: Superheterodyne

Type of Signal: Cw, mow, voice

Output Impedance: 600 ohms

Antenna Type: 7 section 24-foot vertical whip, or 30-foot single-wire L-type*Power Requirements:*

Standard:

Transmitter: Hand-driven generator*Receiver:* Battery pack

Optional:

Transmitter:

EF Series Gasoline Engine-Driven Generator Equipment

EG Series AC Motor Generator Equipment, 115-v 60-cycle 1-phase ac

EH Series DC Motor Generator Equipment, 115-v dc

EJ Series Dynamotor Equipment, 12-v dc

Receiver:

EL Series Auxiliary Rectifier Power Equipment, 115-v 60-cycle 1-phase ac

EM Series Auxiliary Dynamotor Equipment, 6-v dc

EN Series Auxiliary Dynamotor Equipment, 12-v dc

EO Series Auxiliary Dynamotor Equipment, 24-v dc

EP Series Auxiliary Dynamotor Equipment, 32-v dc

EQ Series Auxiliary Dynamotor Equipment, 110-v dc

MAJOR COMPONENTS

QTY	ITEM	STOCK NUMBERS	DIMENSIONS (Inches)	WEIGHT (Lbs)
1	AC Motor Generator Equipment EG Series (Supplied by request)	-----	7-19/32 x 8-7/16 x 23-5/16	134.2
1	Antenna Assembly	-----	-----	7.5
1	Auxiliary Dynamotor Equipment EM Series 6-v dc (May be supplied instead of dry battery)	-----	7-13/16 x 8-5/8 x 5-1/8	11.5
1	Auxiliary Dynamotor Equipment EM Series 12-v dc (May be supplied instead of dry battery)	-----	7-13/16 x 8-5/8 x 5-1/8	11.5

AN/PRC-type PORTABLE RADIO AND RECEIVING EQUIPMENT

MAJOR COMPONENTS—Continued

QTY	ITEM	STOCK NUMBERS	DIMENSIONS (Inches)	WEIGHT (Lbs)
1	Auxiliary Dynamotor Equipment EO Series 24-v dc (May be supplied instead of dry battery)	-----	7-13/16 x 8-5/8 x 5-1/8	11.5
1	Auxiliary Dynamotor Equipment EP Series 32-v dc (May be supplied instead of dry battery)	-----	7-13/16 x 8-5/8 x 5-1/8	11.5
1	Auxiliary Dynamotor Equipment EQ Series 110-v dc (May be supplied instead of dry battery)	-----	7-13/16 x 8-5/8 x 5-1/8	11.5
1	Auxiliary Rectifier Power Equipment EL Series 115-v ac (May be supplied instead of dry battery)	-----	9-3/4 x 9-1/4 x 8-7/8	19
7	Batteries			
	(2) Type 19010	-----	4-5/16 x 2-5/8 x 2-5/8	
	(3) Type 19005	-----	6-5/8 x 2-11/16 x 4-1/4	
	(2) Type 19011	-----	2-13/16 x 7/8 x 4-1/16	
1	DC Motor Generator Equipment EH Series (Supplied by request)	-----	7-19/32 x 8-7/16 x 23-5/16	134.2
1	Dynamotor Equipment EJ Series (Supplied by request)	-----	6-13/16 x 9-1/4 x 7-21/32	20
1	Gasoline Engine-Driven Generator Equipment EF Series (Supplied by request)	-----	-----	60.5
1	Generator, Hand- or Engine-Driven 21263A	-----	14-1/8 x 19 1/2 x 6-11/32	22.3
1	Shipping Chest for Complete Basic TBX 10017A	-----	17-3/4 x 49-3/4 x 18-3/8	82
1	Transmitter-Receiver Unit 43005C	-----	8-1/2 x 15-53/64 x 10	29

REFERENCE DATA AND LITERATURE:

SHIPPING DATA

PKGS	VOLUME (Cu Ft)	WEIGHT (Lbs)
1	17.7	355

PORTABLE RADIO AND RECEIVING EQUIPMENT **AN/PRC-type**

PROCUREMENT DATA

PROCURING SERVICE: USN
SPEC &/or DWG:

DESIGN COG: USN, BuShips

CONTRACTOR	LOCATION	CONTRACT OR ORDER NO.	APPROX UNIT COST
General Electric Co.	Schenectady, N. Y.	NXsr-35352, 30 Jul 1943	\$1,100.00

PORTABLE RADIO TRANSMITTING AND RECEIVING EQUIPMENT **AN/PRC-type**

4 December 1958

Cognizant Serv: USN FSN:

TBX-8

	USA	USN	USAF
TYPE CLASS:	--	Used by	--
STOCK NO:	--	12-550 dc: F16-Q- 317170-200	--
		12 dc: F16-Q-317145- 200	
		115 ac: F16-Q-317155- 200	
		550 dc: F16-Q-317165- 200	



TBX-8

FUNCTIONAL DESCRIPTION:

Portable Radio Transmitting and Receiving Equipment TBX-8 is a three-man carry, transmitter-receiver for general field use.

The basic set uses a hand generator as the transmitter power source and batteries for the receiver. However, for installations at shore stations and on surface craft, certain auxiliary power supplies are available.

The TBX-8 differs in many respects from the earlier Portable Radio Transmitting and Receiving Equipments TBX series.

Equipment required but not supplied: (10) Crystals CR-5B/U in holder, Telephone Headset 49057-A, Telephone Extension Cord and Plug Assembly 49534, Lip Microphone Assembly 51071, Microphone Extension Cord and Switch Assembly 49561, Telegraph Key and Leg Band Assembly 26022.

TECHNICAL CHARACTERISTICS:

Maximum Range: 30 miles

Transmitter:

Frequency Range: 2,000 to 5,800 kc

AN/PRC-type PORTABLE RADIO TRANSMITTING AND RECEIVING EQUIPMENT

Frequency Channels: 2 preset at any frequency, 2,000 to 4,200 kc

Frequency Control: Master oscillator and crystal

Type of Signal: Cw, voice

Modulation Capability: 90%

Power Output:

Cw: 8.5 w

Voice: 2.5 w with long wire antenna

Stability:

Crystal: 0.03%

Master oscillator: 0.25%

Receiver:

Type: Superheterodyne

Frequency Range: 2,000 to 8,000 kc

Sensitivity:

Cw: 20 uv with 14 db signal-plus-noise-to-noise ratio

Voice: 10 uv with 14 db signal-plus-noise-to-noise ratio

IF: 1.515 mc

Type of Signal: Cw, mew, voice

Antenna Type: Whip or single-wire, end fed

Power Requirements:

Transmitter: 550/12-6 v, dc hand generator

Receiver: Two 45 v-19005 dry battery, two 1.5 v-19010 dry battery, and one 7.5 v-19011 dry battery

Auxiliary Power Units Available:

For Transmitter: Gasoline Engine Driven Generator Equipment EF-8 AC Motor Generator Equipment EG-7, DC Motor Generator Equipment EH Dynamotor Equipment EJ-7 Vibrator Power Supply Type 20337

For Receiver: Auxiliary Rectifier Power Equipment EL, EAD Auxiliary Dynamotor Equipment EM, EN, EO, EP, EQ, EAP; Vibrator Power supply Type 20337

MAJOR COMPONENTS

QTY	ITEM	STOCK NUMBERS	DIMENSIONS (Inches)	WEIGHT (Lbs)
1	Adaptor Unit 632246	-----	2-3/4 x 2-9/16 x 4-5/32	0.5
	Antenna system	-----	-----	10.5
	Battery Cable 49574	-----	36 long	
1	Carrying Case-10375	-----		
1	Crystal Calibrator and Monitor 60133	-----	6-3/4 x 5-1/4 x 2-11/16	
	Generator Cable 49044-A	-----	240 long	
	Generator, Hand or Engine Driven CG-21263-B	-----	9 x 9-1/2 x 6-11/32	24.3
	Lip Microphone Assembly 51071	-----		
	Microphone Extension Cord and Switch Assembly 49588	-----		
	Remote Control Unit 23453	-----	7-3/16 x 9 x 2-15/16	5.7
1	Shipping Chest 10017-B	-----	17-3/4 x 49-3/4 x 17-3/4	80.0 (empty)
	Telegraph Key and Leg Band Assembly 26022	-----		
	Telephone Extension Cord and Plug Assembly 49534	-----		
	Telephone Headset Assembly 49507-A	-----		
	Transmitter-Receiver Unit 4360 and Rain Shield 10480-A	-----	8-1/2 x 16-1/2 x 10-13/16	32.9

REFERENCE DATA AND LITERATURE:

NAVSHIPS 900,706

 PORTABLE RADIO TRANSMITTING AND RECEIVING EQUIPMENT **AN/PRC-type**

SHIPPING DATA

PKGS	VOLUME (Cu Ft)	WEIGHT (Lbs)
1	17.5	320

 PROCUREMENT DATA

PROCURING SERVICE: USN
 SPEC &/or DWG:

DESIGN COG: USN, BuShips

CONTRACTOR	LOCATION	CONTRACT OR ORDER NO.	APPROX UNIT COST
Garod Radio Corp.	Brooklyn, N. Y.	NXsr-38500, 22 Apr 1944 NXsr-69224, 2 Mar 1945 NXsr-71254, 28 Jul 1944	

RADIO RECEIVER **AN/PRR-type**

1 July 1958

Cognizant Serv: USA FSN:

R-62/PR

USA

USN

USAF

TYPE CLASS: S/Std
 STOCK NO: 2C4180-62

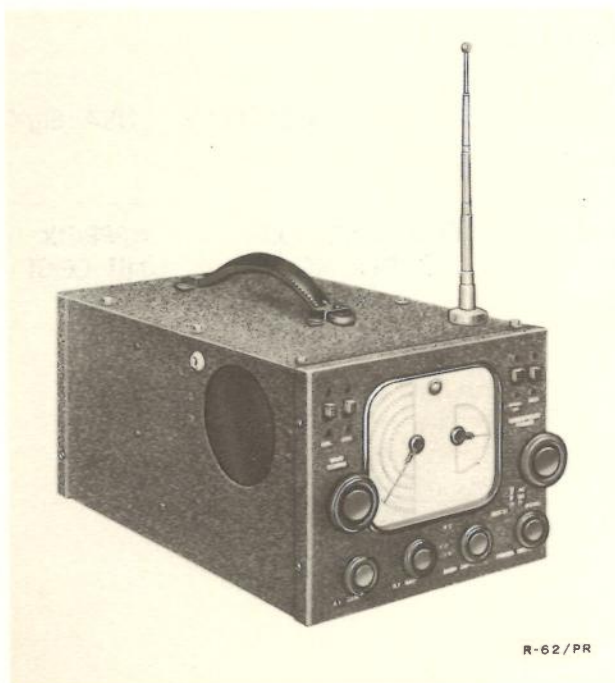
**FUNCTIONAL DESCRIPTION:**

Radio Receiver R-62/PR is a hand-carried, AM (voice, tone, and cw) radio receiving equipment used for intercept, monitoring, and similar applications in the mf and hf bands.

This equipment consists of a radio receiver in a steel cabinet having a carrying handle, a telescoping antenna, and a built-in loudspeaker. Provision is made for use of headphones and connection to a straight wire antenna and ground. This set has automatic or manual volume controls, automatic noise level adjustment, standby and beat-frequency oscillator switches, AF and RF gain controls, and band-spread tuning.

TECHNICAL CHARACTERISTICS:

Frequency Range in Mc: 0.5 to 30.5 in 4 bands

Type Modulation: AM

Type of Signal: Cw, tone, voice

Power Requirements: 40 w, 115-v ac or dc; or one 6-v A battery and two 45-v B batteries

MAJOR COMPONENTS

QTY	ITEM	STOCK NUMBERS	DIMENSIONS (Inches)	WEIGHT (Lbs)
		(USA)		
1	Radio Receiver R-62/PR (Equipment consists of a single major component.)	2C4180-62	7 x 8-1/2 x 13-1/4	18

REFERENCE DATA AND LITERATURE:

TM 11-876

MIL-HDBK-161

AN/PRR-type RADIO RECEIVER

SHIPPING DATA

PKGS	VOLUME (Cu Ft)	WEIGHT (Lbs)
1	2.2	58

PROCUREMENT DATA

PROCURING SERVICE: USA
SPEC &/or DWG:

DESIGN COG: USA, Sig C

CONTRACTOR	LOCATION	CONTRACT OR ORDER NO.	APPROX UNIT COST
The Hallicrafters Co.	Chicago, Ill.	17018-P-44-03	

RADIO RECEIVER **AN/PRR-type**

1 July 1958

Cognizant Serv: USA FSN: 5820-164-7170

R-80()/PR

USA

USN

USAF

TYPE CLASS: S/Std
 STOCK NO: 2C4180-80

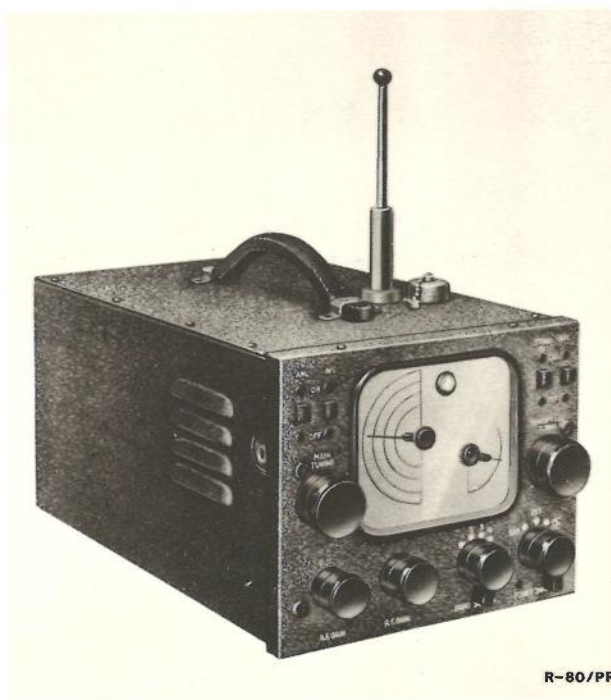
**FUNCTIONAL DESCRIPTION:**

Radio Receiver R-80()/PR is a general purpose, hand-carried radio receiving equipment that receives AM (voice, tone, and cw) signals in the mf and hf bands. It is used for communication, intercept, monitoring, and similar applications at tactical or fixed stations.

This equipment consists of a radio receiver in a steel cabinet having a carrying handle, a telescoping antenna, and a built-in loudspeaker. It has automatic and manual volume controls, automatic noise level adjustment, AF and RF gain controls, standby and beat-frequency oscillator switches, and band-spread tuning. Provision is made for use of headphones and connection to a long-wire antenna and ground

TECHNICAL CHARACTERISTICS:

Frequency Range in Mc: 0.55 to 30.5 in 4 bands

Type Modulation: AM

Type of Signal: Cw, voice, tone

Power Requirements: 50 w, 110/117-v ac or dc or one 6-v A battery and two 45-v B batteries

MAJOR COMPONENTS

QTY	ITEM	STOCK NUMBERS	DIMENSIONS (Inches)	WEIGHT (Lbs)
		(FSN)		
1	Radio Receiver R-80/PR (Equipment consists of only one major component.)	5820-164-7170	9 x 9 x 15	28

REFERENCE DATA AND LITERATURE:

TM 11-876

MIL-HDBK-161

AN/PRR-type RADIO RECEIVER

SHIPPING DATA

PKGS	VOLUME (Cu Ft)	WEIGHT (Lbs)
1	2.2	58

PROCUREMENT DATA

PROCURING SERVICE: USA
SPEC &/or DWG:

DESIGN COG: USA, Sig C

CONTRACTOR	LOCATION	CONTRACT OR ORDER NO.	APPROX UNIT COST
The Hallicrafter Co.	Chicago, Ill.	19643-P-50-6	\$198.00

RADIO RECEIVER **AN/PRR-type**

1 July 1958

Cognizant Serv: USA FSN: 5820-242-5210

R-206()/PR

USA

USN

USAF

TYPE CLASS:

L/Std

--

--

STOCK NO:

2C4573

--

--

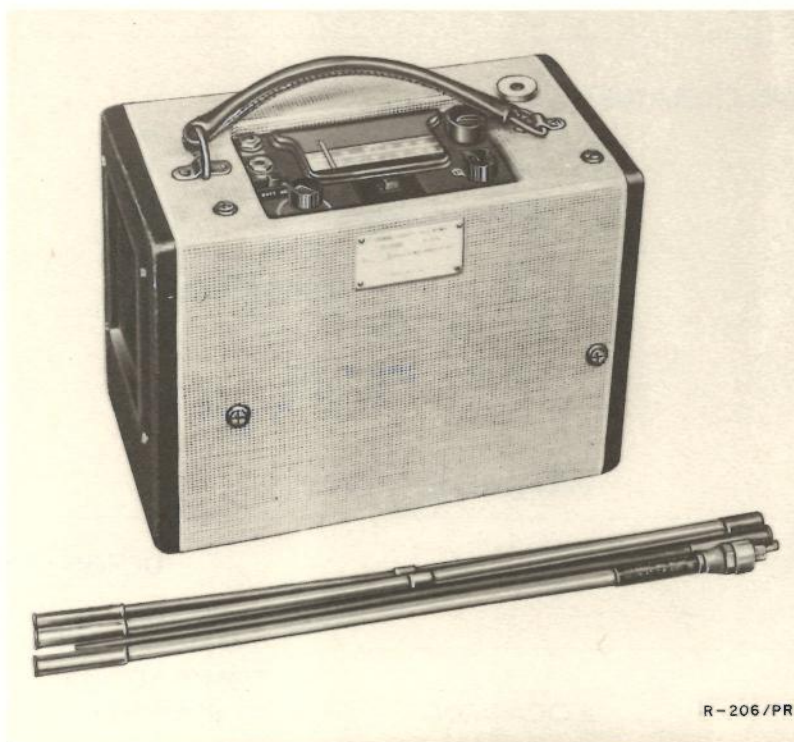

R-206/PR

FUNCTIONAL DESCRIPTION:

Radio Receiver R-206()/PR is a highly portable, three-band, special purpose, AM (voice and tone) receiving equipment used in the low-, medium-, and high-frequency bands for checking range courses and for similar applications.

This equipment consists of a small compact radio receiver contained in a suitcase-type housing. It has a built-in speaker and an output jack for connection of a headset. A loop antenna is used on frequency bands 1 and 2 (0.195 to 0.41 and 0.54 to 1.56 mc); a whip-type antenna is used on all three bands.

This set has been replaced by Radio Receiver AN/SRC-7().

TECHNICAL CHARACTERISTICS:*Frequency Range in Mc:*

Band 1: 0.195 to 0.41

Band 2: 0.54 to 1.56

Band 3: 2.20 to 6.20

Type Modulation: AM*Type of Signal:* Voice, tone*Power Output:*

Battery Operation: 50 mcw

Ac or dc Operation: 0.5 w

Power Requirements: 115-v 50/60-cycle ac; or 40 w, 115-v dc; or 7.5 v dc from one A battery and 45-v dc from two B batteries

MIL-HDBK-161

AN/PRR-type RADIO RECEIVER

MAJOR COMPONENTS

QTY	ITEM	STOCK NUMBERS	DIMENSIONS (Inches)	WEIGHT (Lbs)
1	Radio Receiver R-206()/PR (Equipment consists of only one major component.)	(FSN) 5820-242-5210 (USA) 2C4573	8-1/2 x 6-1/2 x 12	10.5

REFERENCE DATA AND LITERATURE:

TM 11-5011

SHIPPING DATA

PKGS	VOLUME (Cu Ft)	WEIGHT (Lbs)
1	2.25	21.5

PROCUREMENT DATA

PROCURING SERVICE: USA
SPEC &/or DWG:

DESIGN COG: USA, Sig C

CONTRACTOR	LOCATION	CONTRACT OR ORDER NO.	APPROX UNIT COST
Midwest Engineering Development Co., Inc. (R-206A/PR)	Kansas City, Mo.	11919-P-47	

RADIO RECEIVING EQUIPMENT **AN/PRR-type**

5 December 1958

Cognizant Serv: USN FSN: 5820-665-1227

RBZ

USA

USN

USAF

TYPE CLASS:

Used by

Used by

--

STOCK NO:

2C4010

--

--

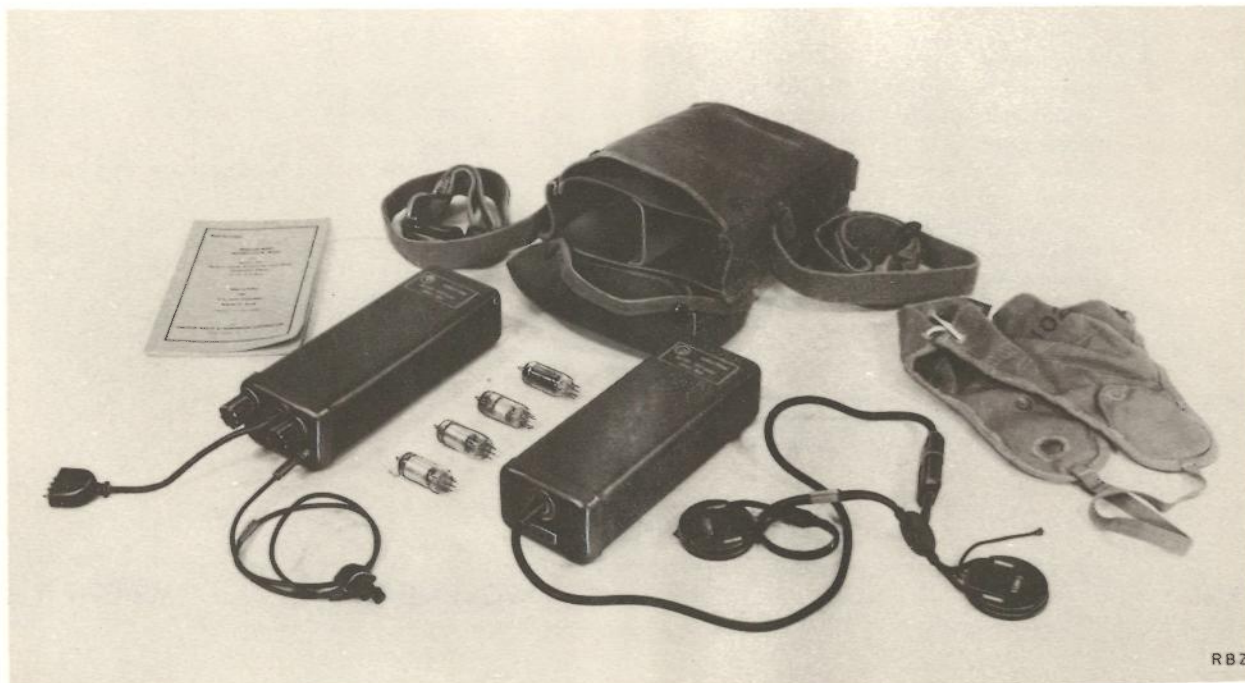
**FUNCTIONAL DESCRIPTION:**

Radio Receiving Equipment RBZ is a lightweight, compact radio receiver designed for shore use and intended to be carried on the chest in a canvas case secured by shoulder straps. The circuit used is that of a five-tube permeability-tuned superheterodyne receiver with automatic volume control.

The equipment consists principally of a radio receiver, a battery power unit, an antenna lead, and headphones. The antenna lead consists of a flexible rubber-covered cable. A clamp on one end fastens to a standard metal helmet which acts as the antenna. A length of wire may be used as an antenna in place of the helmet. Headphones, mounted in a canvas skull cap, are designed for use under the helmet.

The receiver derives its operating power from dry batteries—two Batteries BA-30 and one Battery BA-51—which are carried in the watertight plastic battery case.

TECHNICAL CHARACTERISTICS:

Frequency Range in Mc: 2 to 5.8

Type Reception: Mcw, voice

Sensitivity: 1 to 4 uv for output of 1 mw

Power Output: Suitable for headphone operation

Output Impedance: 600 ohms

Intermediate Frequency: 455 kc

Image Rejection Ratio: 100 to 1

Low-voltage Battery Life Expectancy: 8 to 10 hours continuous operation

High-voltage Battery Life Expectancy: 40 to 50 hours, depending on sensitivity that can be tolerated

Power Requirements: Two 1.5-v Batteries BA-30, one 67.5-v Battery BA-51

AN/PRR-type RADIO RECEIVING EQUIPMENT**MAJOR COMPONENTS**

QTY	ITEM	STOCK NUMBERS	DIMENSIONS (Inches)	WEIGHT (Lbs)
		(USA)		
1	Radio Receiving Equipment RBZ, including:	2C4010	7 x 3-1/2 x 5-1/2	5.5
1	Battery Holder 19140	2Z5042-31	2-1/2 x 1-3/4 x 7-1/2	
1	Battery Power Unit 19040	-----	1-7/8 x 2-7/8 x 8	1.812
1	Cable Assembly 49238	3E6572-4	27 long	.94
1	Canvas Carrying Case 10203	-----	-----	1
2	Case (phenolic) 10172	2Z1800.53	3 x 2 x 8-3/4	
1	Headband 10204	2B740-1	17 x 9	
1	Headset Assembly 49214	2B971-8	-----	.5
1	Radio Receiver Unit 46203	2C4011	1-7/8 x 2-7/8 x 8	1.875

REFERENCE DATA AND LITERATURE:

Technical manual for Radio Receiving Equipment RBZ

SHIPPING DATA

PKGS	VOLUME (Cu Ft)	WEIGHT (Lbs)
1	1.8	19

PROCUREMENT DATA

PROCURING SERVICE: USN

DESIGN COG: USN, BuShips

SPEC &/or DWG:

CONTRACTOR	LOCATION	CONTRACT OR ORDER NO.	APPROX UNIT COST
Emerson Radio & Phonograph Corp.	New York, N. Y.	NXss-15891	\$70 with equip- ment spares.

PORTABLE RADIO RECEIVING EQUIPMENT AN/PRR-type

5 December 1958

Cognizant Serv: USN FSN:

RCB-1

USA

USN

USAF

TYPE CLASS: --

Used by --

STOCK NO: --

--

--

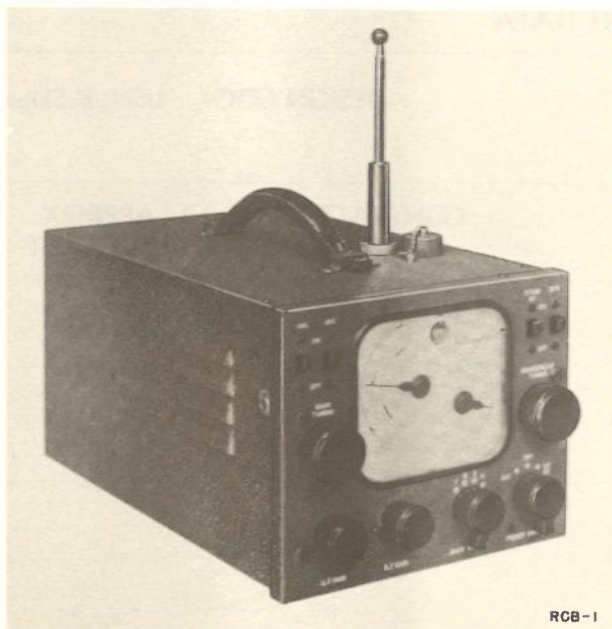

FUNCTIONAL DESCRIPTION:

Portable Radio Receiving Equipment RCB-1 consists of a completely self-contained nine-tube superheterodyne communications receiver mounted in a steel cabinet suitable for table operation or portable use. A self-contained telescoping antenna, speaker and batteries are provided.

This equipment provides continuous coverage of the broadcast and shortwave bands accepting either continuous-wave telegraph or amplitude-modulated telephone signals.

The receiver may be operated from either alternating-current or direct-current commercial power sources. An external antenna may be used to increase the overall performance.

TECHNICAL CHARACTERISTICS:

Frequency Range in Mc: 0.55 to 30 in four bands

Intermediate Frequency: 455 kc

Tone Frequency: 1,000 cycles

Antenna Type: Built-in telescoping ships external long wire (50 to 100 feet), or external half-wave doublet resonate at particular frequency desired

Power Requirements: 6- and 90-v dc, 110- to 117-v 60-cycle 1-phase ac or 110- to 117-v dc

MAJOR COMPONENTS

QTY	ITEM	STOCK NUMBERS	DIMENSIONS (Inches)	WEIGHT (Lbs)
1	Portable Radio Receiving Equipment Model RCB-1 (Equipment consists of only one major component.)	-----	9 x 9 x 15	28

REFERENCE DATA AND LITERATURE:

MIL-HDBK-161

AN/PRR-type PORTABLE RADIO RECEIVING EQUIPMENT

SHIPPING DATA

PKGS	VOLUME (Cu Ft)	WEIGHT (Lbs)
------	----------------	--------------

PROCUREMENT DATA

PROCURING SERVICE:
SPEC &/or DWG:

DESIGN COG: USN, BuShips

CONTRACTOR	LOCATION	CONTRACT OR ORDER NO.	APPROX UNIT COST
The Hallcrafters Co.	Chicago, Ill.	NXsr-39204	

PORTABLE RADIO RECEIVING EQUIPMENT AN/PRR-type

20 November 1958

Cognizant Serv: USN FSN:

RDR

USA

USN

USAF

TYPE CLASS: --

Used by

--

STOCK NO: --

F16-Q-272190-200

--

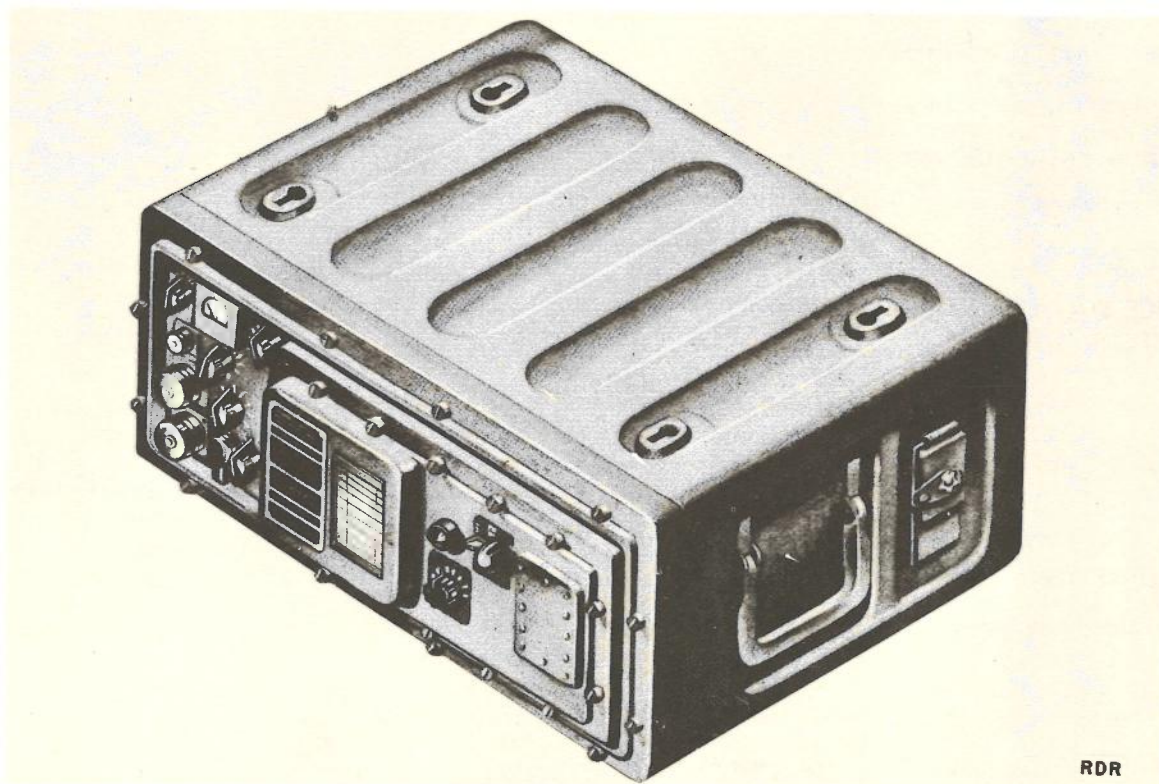

RDR

FUNCTIONAL DESCRIPTION:

Portable Radio Receiving Equipment RDR is designed for ship, shore, field, and vehicular use over line-of-sight distances. It contains 10 crystal-controlled heterodyning frequencies and any one of the 10 preset channels may be selected by a motor-driven selector mechanism that may be either locally or remotely actuated.

This equipment was designed as a companion receiver to Radio Transmitting and Receiving Equipment MAR and is housed in the same type case to permit grouping and mounting with other MAR units.

TECHNICAL CHARACTERISTICS:

Frequency Range in Mc: 125 to 390 mc in 10 preset channels

Frequency Control: Crystal

Reception: Mcw, voice

Power Output: 1 w into 600-ohm load

Output Impedance: 600 ohms

Sensitivity: 8 uv input for signal-to-noise ratio of 10.1

Antenna: Half-wave, center-fed dipole

Input Impedance: 50 ohms

IF.: 30.2 mc

Power Requirements: 145 w, 13-v dc or 13-v ac and 375-v dc
(Selector motor load not included)

MIL-HDBK-161

AN/PRR-type PORTABLE RADIO RECEIVING EQUIPMENT

MAJOR COMPONENTS

QTY	ITEM	STOCK NUMBERS	DIMENSIONS (Inches)	WEIGHT (Lbs)
1	Antenna Assembly, CRV-66147	-----	22 (high) x 25 (deep)	3.5
1	*Antenna Carrying Case, NT-10591	-----		
1	*Gasoline Engine Generator Set CCW-73037	-----		
1	*Metal Carrying Case for Engine CBDV-10620	-----	14-3/4 x 12 x 17-9/16	
1	Radio Receiver, CRV-46283	-----	9-1/2 x 21-1/4 x 16-1/4	54

* Optional equipment furnished only for field operation.

REFERENCE DATA AND LITERATURE:

NAVSHIPS 900,841(A)

SHIPPING DATA

PKGS	VOLUME (Cu Ft)	WEIGHT (Lbs)
Without Optional Field Equipment: 4	20.4	347
With Optional Field Equipment: 6	47.6	867

PROCUREMENT DATA

PROCURING SERVICE: USN
SPEC &/or DWG:

DESIGN COG: USN, BuShips

CONTRACTOR	LOCATION	CONTRACT OR ORDER NO.	APPROX UNIT COST
RCA Victor Division, Radio Corp. of America	Camden, N. J.	NXsr-60008	\$3,000.00

REMOTE CONTROL EQUIPMENT AN/PRW-type

5 December 1958

Cognizant Serv: USA FSN: 5820-228-6108

RC-261

	USA	USN	USAF
TYPE CLASS:	L/Std	--	--
STOCK NO:	2C7600-261	--	--

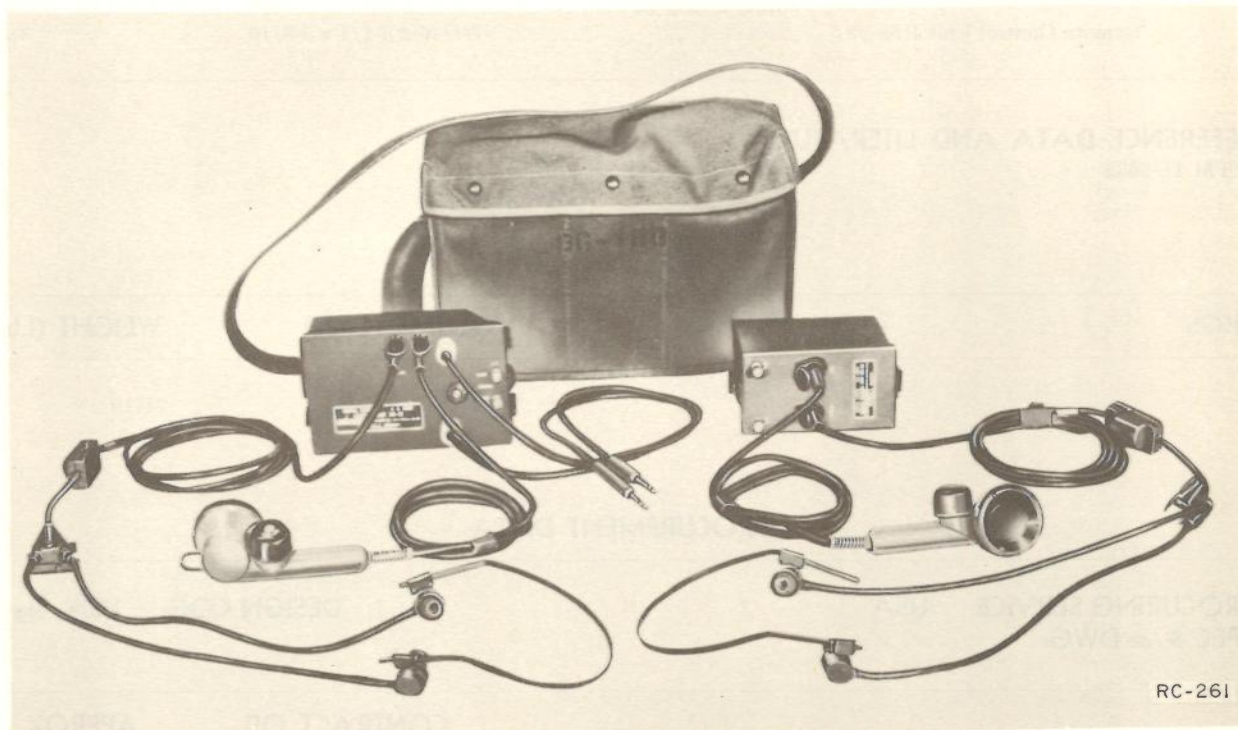

RC-261

FUNCTIONAL DESCRIPTION:

Remote Control Equipment RC-261 is an assemblage of items enabling the erection of a local-battery telephone facility between a remote operating position and the actual site of a radio equipment.

This equipment consists essentially of a control station designed to be operated at the remote point, a control box used at the radio set, and accessories. The remote control unit may be connected to the control box at the radio set by field wire.

The equipment is powered by dry batteries and by the hand magneto unit, which is integral in the remote control unit.

TECHNICAL CHARACTERISTICS:

Type of Signal: Cw, voice

Type Communication Circuits: Local battery telephone

Controls: A switch marked RADIO, REMOTE, INTERPHONE; impedance switch marked HIGH-LOW; and press-to-talk switch

Power Requirements: 3-v dc (two Batteries BA-30); 6-v dc (four Batteries BA-30)

MIL-HDBK-161

AN/PRW-type REMOTE CONTROL EQUIPMENT

MAJOR COMPONENTS

QTY	ITEM	STOCK NUMBERS	DIMENSIONS (Inches)	WEIGHT (Lbs)
1	Bag BG-186	-----	15-1/2 x 5 x 9-5/8	2
1	Control Unit RM-53	(FSN) 5820-221-0204 (USA) 2C680-53	8-1/2 x 4-3/8 x 4-3/8	4.94
1	Remote Control Unit RM-52	-----	7-1/16 x 3-1/4 x 5-3/16	3.5

REFERENCE DATA AND LITERATURE:

TM 11-2632

SHIPPING DATA

PKGS	VOLUME (Cu Ft)	WEIGHT (Lbs)
1	3.9	71.19

PROCUREMENT DATA

PROCURING SERVICE: USA
SPEC &/or DWG:

DESIGN COG: USA, Sig C

CONTRACTOR	LOCATION	CONTRACT OR ORDER NO.	APPROX UNIT COST
------------	----------	--------------------------	---------------------

\$83.00

REMOTE CONTROL EQUIPMENT AN/PRW-type

1 July 1958

Cognizant Serv: USA FSN: 5820-170-4789

RC-289

USA

USN

USAF

TYPE CLASS:

Std

--

--

STOCK NO:

2C7600-289

--

--

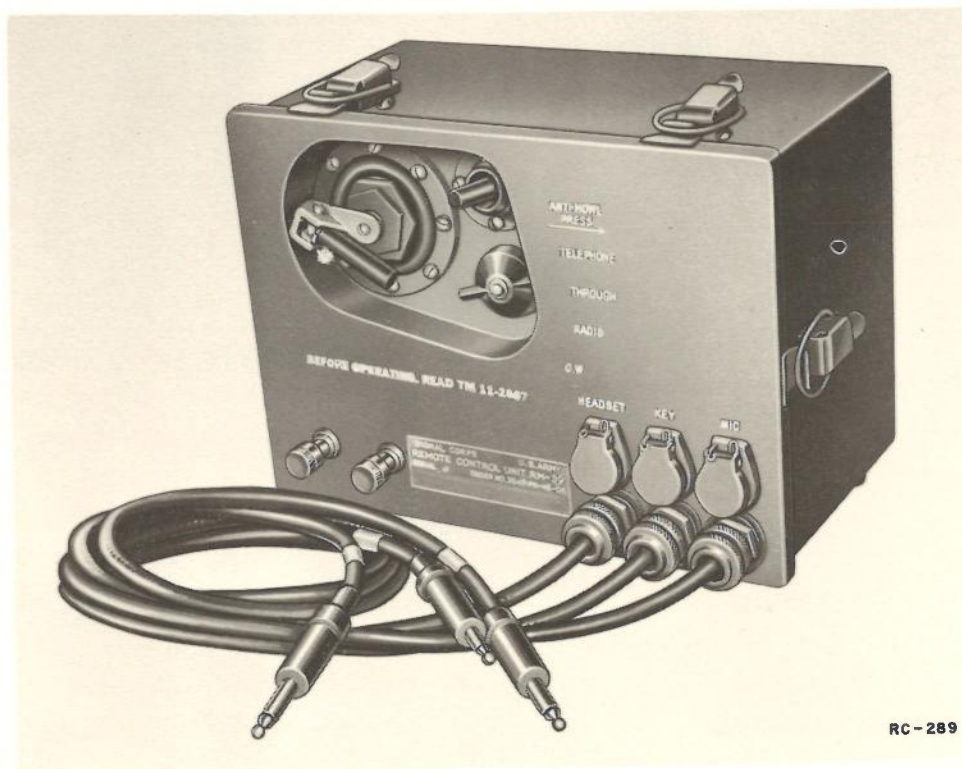
**FUNCTIONAL DESCRIPTION:**

Remote Control Equipment RC-289 is an assemblage of items enabling the erection of a local-battery telephone facility between a remote operating position and the actual site of the radio equipment.

This equipment consists essentially of a modified steel-cased Telephone EE-8, a telegraph key, and a standard field Telephone EE-8. The connecting facility is usually a conventional field telephone pair. Telephone EE-8 is located at the remote station; the remote control unit is installed at the radio set.

The modes of operation available are local-battery telephone communication between remote point and radio operator, control of radio equipment from the remote Telephone EE-8, voice circuit monitoring by the radio operator at the

radio equipment, and operation of the radio set (voice or cw) with monitoring at either the remote station or the radio set.

It is powered by dry batteries and uses the hand generator integral in the remote control unit or in a Telephone EE-8 for ringing.

TECHNICAL CHARACTERISTICS:

Type of Signal: Cw and voice

Type Communication Circuits: Local battery telephone

Controls: Four-position switch marked TELEPHONE, THROUGH, RADIO, CW; Crank GC-9; and toggle switch marked ANTI-HOWL

Power Requirements: 4-1/2-v dc (Battery BA-27); 15-v dc (two Batteries BA-34); 1.5 v dc (Battery BA-30)

MIL-HDBK-161

AN/PRW-type REMOTE CONTROL EQUIPMENT

MAJOR COMPONENTS

QTY	ITEM	STOCK NUMBERS	DIMENSIONS (Inches)	WEIGHT (Lbs)
		(USA)		
1	Case CS-76-J	2Z1876	9-7/8 x 8-5/8 x 6-3/4	2
1	Control Unit RM-39	2C679-39	9-5/16 x 6-5/8 x 5	12.9
1	Key J-47	3Z23447	-----	.3
1	Telephone EE-8	4B5008	-----	12.9

REFERENCE DATA AND LITERATURE:

TM 11-2667

SHIPPING DATA

PKGS	VOLUME (Cu Ft)	WEIGHT (Lbs)
1	2.2	70

PROCUREMENT DATA

PROCURING SERVICE: USA
SPEC &/or DWG:

DESIGN COG: USA, Sig C

CONTRACTOR	LOCATION	CONTRACT OR ORDER NO.	APPROX UNIT COST
Teletone Radio Co.	Elizabeth, N. J.	3205-P-51-01	\$69.00

AUDIO FREQUENCY MONITOR AN/PTA-1

25 November 1958

Cognizant Serv: USA FSN: 6625-668-9525

	USA	USN	USAF
TYPE CLASS:	Std	--	--
STOCK NO:	4C5633-1	--	--

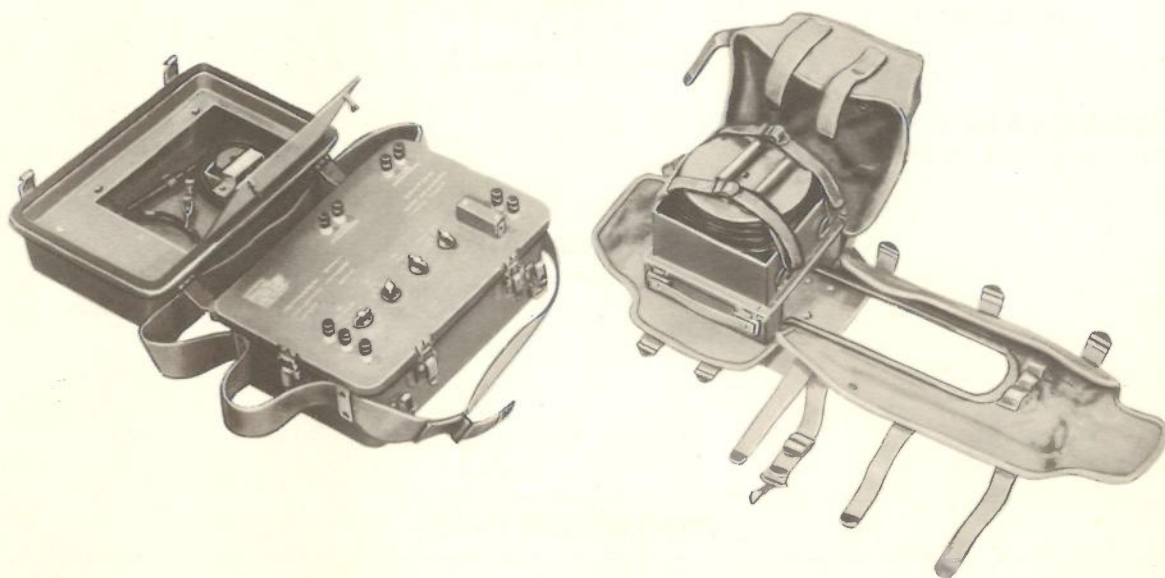

AN/PTA-1

FUNCTIONAL DESCRIPTION:

Audio Frequency Monitor AN/PTA-1 is a battery-operated wire tapping device used in the interception of communication signals transmitted over telephone wire circuits.

The intercepted signal can be recorded, but recording equipment is not supplied as part of this assemblage.

For convenience, this equipment is packed in two units for transportation and can be easily carried by one man.

TECHNICAL CHARACTERISTICS:

Frequency Range: 200 to 8,000 cps

Number of Bands: 1

Audio Frequency Amplifier AM-558/PTA-1:

Input Impedance: 20; 150; 500; 1,000; 2,000; 3,500; 5,000;

500,000 ohms; a ninth impedance position labeled FOR DIRECT CONNECTION TO LINES is for wire line bridging use

Output Impedance: 600 ohms

Input Impedance Accuracy: $\pm 10\%$, FILTER switch B at 200 to 8,000 cps

$\pm 20\%$, FILTER switch B at 200 to 3,000 cps

$\pm 20\%$, FILTER switch B at 300 to 8,000 cps

$\pm 25\%$, FILTER switch B at 300 to 3,000 cps

Output Impedance Accuracy: $\pm 10\%$ at 1,000 cps

Amplifier Gain: 90 db at 1,000 cps, minimum; 85 db between 200 and 8,000 cps

Power Output: Plus 10 dbm

Distortion: 7% (maximum) at maximum power

Power Requirements: 6 v, 50-ma dc (fil); 90 v, 5-ma dc (p)

MIL-HDBK-161

AN/PTA-1 AUDIO FREQUENCY MONITOR

MAJOR COMPONENTS

QTY	ITEM	STOCK NUMBERS	DIMENSIONS (Inches)	WEIGHT (Lbs)
1	Amplifier, Audio Frequency AM-558/PTA-1	2C448-558	8-3/4 x 10-5/8 x 15-3/8	20
1	Headset, Electrical H-113/U	5965-504-6370		
1	Transformer, Audio Frequency TF-148/PTA-1	5950-030-2985	1-5/8 x 1-7/8 x 2-15/16	.5

REFERENCE DATA AND LITERATURE:

TM 11-2099/TO16-30PTA1-6

SHIPPING DATA

PKGS	VOLUME (Cu Ft)	WEIGHT (Lbs)
1	6.1	82

PROCUREMENT DATA

PROCURING SERVICE: USA
SPEC &/or DWG: MIL-M-10670

DESIGN COG: USA, Sig C

CONTRACTOR	LOCATION	CONTRACT OR ORDER NO.	APPROX UNIT COST
------------	----------	--------------------------	---------------------

EMERGENCY SWITCHBOARD AN/PTC-type

1 July 1958

Cognizant Serv: USA FSN: 5805-162-8191

SB-18-GT

USA

USN

USAF

TYPE CLASS:

Std

--

Std

STOCK NO:

4C9905-18

--

1700-429298000

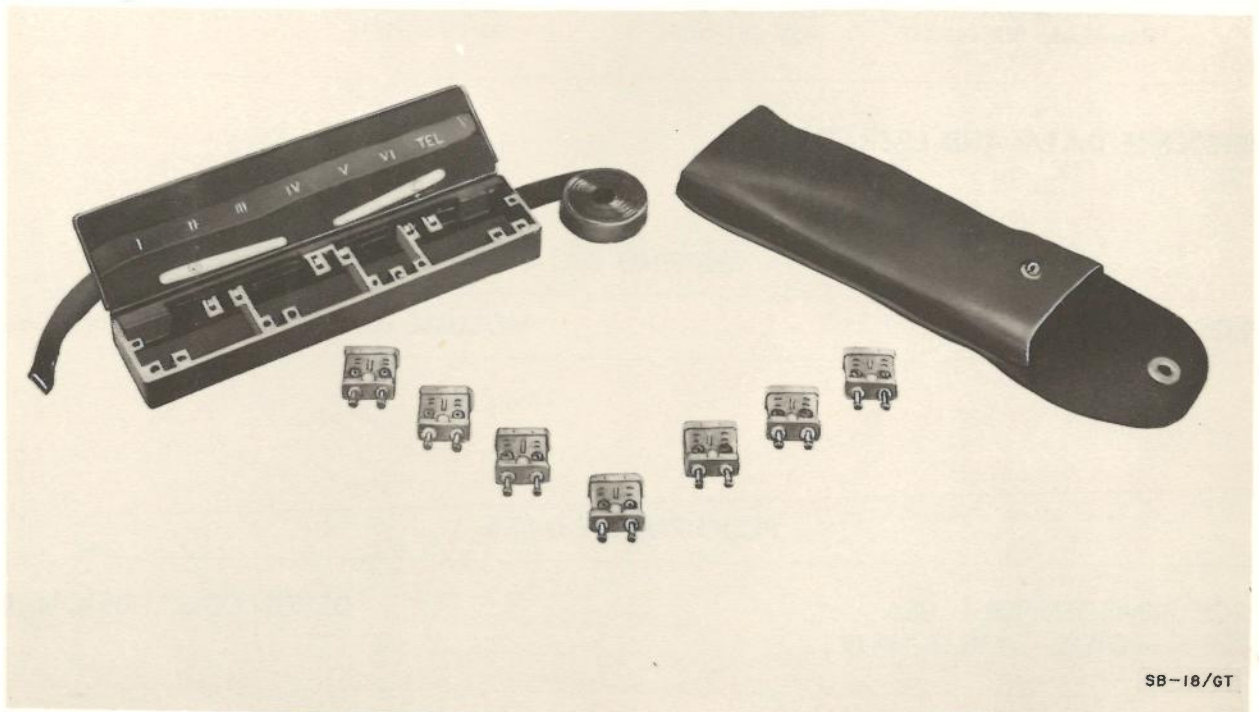

SB-18/GT

FUNCTIONAL DESCRIPTION:

Emergency Switchboard SB-18/GT is a small, compact, lightweight, manual switching equipment used with field wire facilities.

This equipment can be used as an emergency substitute for a six-line magneto telephone switchboard. Switching is performed by interconnecting the adapter plugs in the switchboard. Each adapter plug contains a small neon bulb that serves as a signal lamp when energized by ringing current.

A field telephone, such as the EE-8, is required to operate this switchboard. The operator's telephone supplies switchboard and ringing current.

TECHNICAL CHARACTERISTICS:

Number of Switchboard Positions: 1

Number and Type of Circuits: 6 line

Power Requirements: None

MIL-HDBK-161

AN/PTC-type EMERGENCY SWITCHBOARD

MAJOR COMPONENTS

QTY	ITEM	STOCK NUMBERS (FSN)	DIMENSIONS (Inches)	WEIGHT (Lbs)
7	Adapter Plug U-4/GT	5935-161-6649	2 x 1-1/2 x 5/8	0.1
1	Case CY-229/GT	5805-407-3892	12 x 4 x 1-1/2	
1	Plug Holder MT-313/GT	5805-161-6617	12 x 3 x 1-1/4	

REFERENCE DATA AND LITERATURE:

TB 11-333-1

SHIPPING DATA

PKGS	VOLUME (Cu Ft)	WEIGHT (Lbs)
1	0.02	5

PROCUREMENT DATA

PROCURING SERVICE: USA
SPEC &/or DWG: MIL-S-12479

DESIGN COG: USA, Sig C

CONTRACTOR	LOCATION	CONTRACT OR ORDER NO.	APPROX UNIT COST
Insuline Corp. of America	Manchester, N. H.	4454-P-53-33	\$13.85
S. H. Couch Co., Inc.	North Quincy, Mass.	3545-P-52-03	20.50

MANUAL TELEPHONE SWITCHBOARD AN/PTC-type

1 July 1958

Cognizant Serv: USA FSN: 5805-257-3602

SB-22()/PT

	USA	USN	USAF
TYPE CLASS:	Std	--	Std
STOCK NO:	4C9905-22	--	--

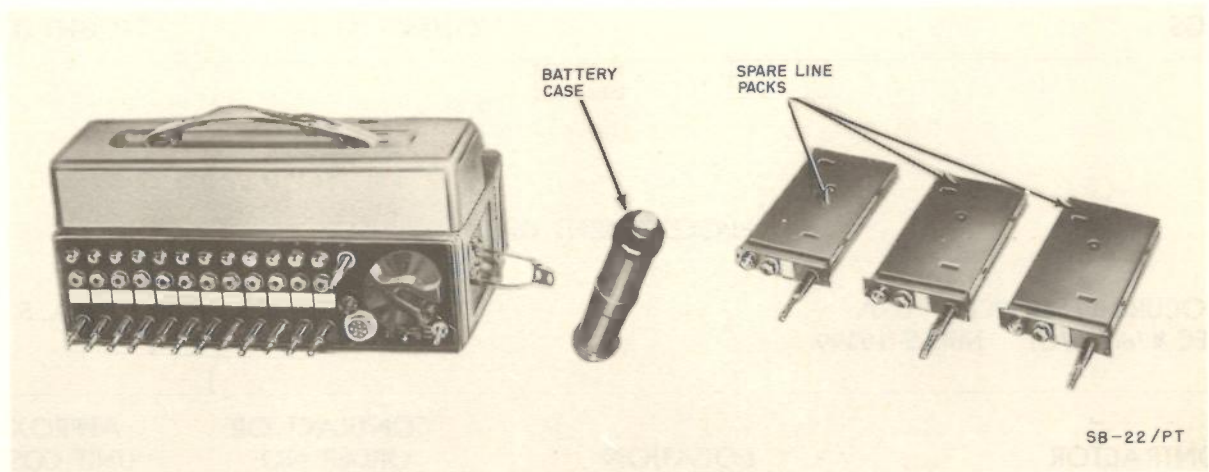

FUNCTIONAL DESCRIPTION:

Manual Telephone Switchboard SB-22()/PT is a small, portable, 12-line monocord switchboard used to interconnect local-battery telephone lines and/or of telegraph equipment.

This equipment consists essentially of a case in which individual line packs and an operator's pack are mounted. This method of design allows rapid replacement of defective circuits. The operator's pack includes a hand-generator for ringing.

Two of these equipments can be stacked and used together to handle 29 lines; in this application the operator's pack is removed from one case and replaced by five additional line packs.

TECHNICAL CHARACTERISTICS:

Number of Switchboard Positions: 1

Number and Type of Circuits: 1 cord; 12 line

Power Requirements: Four Batteries BA-30

MAJOR COMPONENTS

QTY	ITEM	STOCK NUMBERS	DIMENSIONS (Inches)	WEIGHT (Lbs)
		(FSN)		
1	Battery case	6135-635-5223	-----	1.5
1	Handset-Headset H-81/U	6240-196-4501	-----	1.2
1	Switchboard Accessory Kit MX-230/PT	5805-356-2693	5 x 15 x 11-1/2	3.8
1	Switchboard SB-22/PT (bare unit)	-----	12 x 12 x 16-5/16	25

MIL-HDBK-161

AN/PTC-type MANUAL TELEPHONE SWITCHBOARD

REFERENCE DATA AND LITERATURE:

TM 11-2202

SHIPPING DATA

PKGS	VOLUME (Cu Ft)	WEIGHT (Lbs)
1	3.29	58

PROCUREMENT DATA

PROCURING SERVICE: USA
SPEC &/or DWG: MIL-S-10399

DESIGN COG: USA, Sig C

CONTRACTOR	LOCATION	CONTRACT OR ORDER NO.	APPROX UNIT COST
Federal Radio & Telephone Division, International Telephone & Telegraph Corp.	Clifton, N. J.	1672-P-51-31	\$745.04
North Electric Co.	Galion, Ohio	4740-P-52-31	743.54
Stromberg-Carlson Co., Division, General Dynamics Corp.	Rochester, N. Y.	4739-P-52-51	696.30

MANUAL TELEPHONE SWITCHBOARD AN/PTC-type

1 July 1958

Cognizant Serv: USA FSN: 5805-503-2660

SB-86/P

USA

USN

USAF

TYPE CLASS:

Std

Std

STOCK NO:

4C9905-86

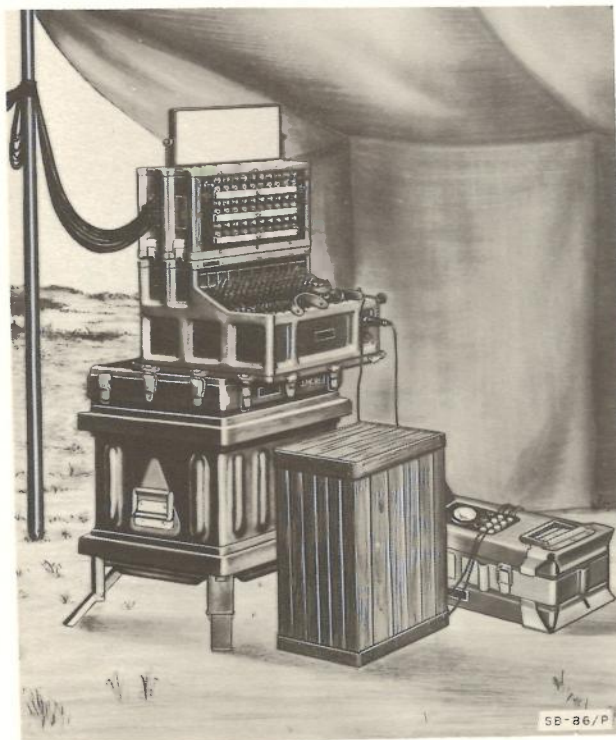

FUNCTIONAL DESCRIPTION:

Manual Telephone Switchboard SB-86/P is a portable, field-type unit used to connect local-battery telephone and voice-frequency teletypewriter lines in many types of wire communication systems.

This equipment is capable of handling 15 calls at a time. Provision is made for automatic and manual ringing, common-battery and magneto signaling, and conference calls. It is mounted for operation on its outer cover assembly. An additional jack field is required to handle more than 30 lines.

Telegraph Terminal TH-5/TG and a teletypewriter are required to complete calls if the vt teletypewriter circuits are set up for telegraph only service.

TECHNICAL CHARACTERISTICS:

Number of Switchboard Positions: 1

Number and Type of Circuits: 16 cord, 30 line (expandable to 60 line with additional equipment), 2 trunk

Ringing: 20 cps from vibrator or hand magneto

Power Requirements:

Common Battery signaling: 20-26.5-v dc from five Batteries BA-200/U

Magneto signaling: 15-26.5-v dc

Night alarm and panel lamps: 3-v dc from two Batteries BA-30

Operator's set: 3-v dc from two Batteries BA-30

MAJOR COMPONENTS

QTY	ITEM	STOCK NUMBERS	DIMENSIONS (Inches)	WEIGHT (Lbs)
		(USA)		
1	Manual Telephone Switchboard Section SB-248/P	4C9905-248	21 x 23-1/2 x 18-1/2	65
1	Power Supply PP-990/G	3H4497-990	10 x 21 x 7-1/8	29
1	Switchboard Signal Assembly TA-207/P	4C9635-2	10 x 4 x 14-1/2	6

MIL-HDBK-161

AN/PTC-type MANUAL TELEPHONE SWITCHBOARD

REFERENCE DATA AND LITERATURE:

TM 11-2134

SHIPPING DATA

PKGS	VOLUME (Cu Ft)	WEIGHT (Lbs)
1	19.95	300

PROCUREMENT DATA

PROCURING SERVICE: USA
SPEC &/or DWG: MIL-S-10446

DESIGN COG: USA, Sig C

CONTRACTOR	LOCATION	CONTRACT OR ORDER NO.	APPROX UNIT COST
Kellogg Switchboard & Supply Co.	Chicago, Ill.	1669-P-51-93	\$1,784.00
North Electric Manufacturing Co.	Galion, Ohio	96-P-52-93	3,215.00

SIGNAL LAMP EQUIPMENT AN/PVC-type

26 November 1958

Cognizant Serv: USA FSN:

EE-80()

	USA	USN	USAF
TYPE CLASS:	Obs	Used by	--
STOCK NO:	--	--	--

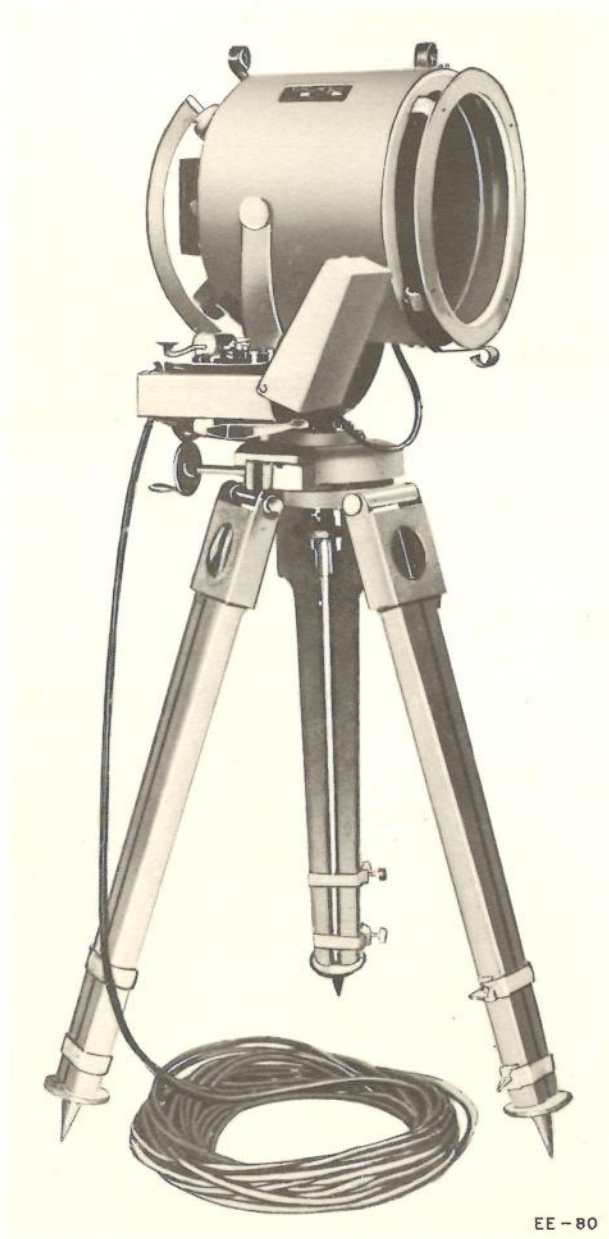

EE-80

FUNCTIONAL DESCRIPTION:

Signal Lamp Equipment EE-80() is a portable, alternating-current or direct-current operated, tripod-mounted signaling lamp in a metal housing, with telegraph key. It provides for signaling with white or colored light in Morse code. Approximate range is 7 miles by day, and 45 miles by night.

It is used in field or harbor defense, coastal signal stations, and similar applications.

This equipment consists of lamp housing with signaling and control fittings; telescoping tripod; white, red, or green light filters; and accessories.

Signal Lamp Equipment EE-80 includes Signal Lamp M-124; Signal Lamp Equipment EE-80-A uses Signal Lamp M-283—these lamps are interchangeable.

Signal Lamp Equipment EE-80 has been superseded by Signal Lamp Equipment EE-80-A.

TECHNICAL CHARACTERISTICS:

Number and Type of Channels: 1 (white, red, or green colored light)

Communication Speed: 5 wpm

Type Light Source: Incandescent lamps

Special Features: Lamp focusing adjustment, peep-sight-type rear sight; crossed-hair-type front sight; gear adjustment mechanism for elevation and azimuth alignment; telegraphic-type signaling key; masking louvres; colored light filters

Power Requirements: 450 w 110-120-v ac or dc

MIL-HDBK-161

AN/PVC-type SIGNAL LAMP EQUIPMENT

MAJOR COMPONENTS

QTY	ITEM	STOCK NUMBERS	DIMENSIONS (Inches)	WEIGHT (Lbs)
		(USA)		
1	Chest CH-24	-----	44-3/4 x 26-1/2 x 26	128
1	Signal Lamp M-124 or M-283, filters, lamps, etc., including:	-----	30 x 18 x 26	74
1	Key J-47	3Z3447		
1	Tripod LG-9	6B1109	38-1/2 x 11	35

REFERENCE DATA AND LITERATURE:

TM 11-390

SHIPPING DATA

PKGS	VOLUME (Cu Ft)	WEIGHT (Lbs)
	4.0	324

PROCUREMENT DATA

PROCURING SERVICE: USA
SPEC &/or DWG:

DESIGN COG: USA, Sig C

CONTRACTOR	LOCATION	CONTRACT OR ORDER NO.	APPROX UNIT COST
------------	----------	--------------------------	---------------------

SIGNAL LAMP EQUIPMENT AN/PVC-type

26 November 1958

Cognizant Serv: USA FSN: 5850-356-3720

EE-84

	USA	USN	USAF
TYPE CLASS:	L/Std	Used by	--
STOCK NO:	--	--	--

**FUNCTIONAL DESCRIPTION:**

Signal Lamp Equipment EE-84 is a portable, visual signaling device which provides communication by flashes of white or red light keyed in accordance with the dots and dashes of telegraphic codes. It is used for line-of-sight communication in airport traffic control, by military police and security troops, and similar units. Approximate range is 2.5 miles in bright sunlight (maximum); many times this range at night.

This equipment consists essentially of a prefocussed lamp in a cylindrical housing, a tripod, and associated battery box. It has a sighting telescope that has illuminated crossed-hairs used in setting up and aiming the device, and a compass and azimuthal scale for orientation.

TECHNICAL CHARACTERISTICS:

Number and Type of Channels: 1 (keyed or interrupted light flashes)

Communication Speed: 8 wpm

Type Light Source: Incandescent lamp, prefocussed, paraboloidal reflector

Special Features: May use filters to modify light to red or other color; includes red filter goggles for reading red light signals

Power Requirements: 8 Batteries BA-30

AN/PVC-type SIGNAL LAMP EQUIPMENT**MAJOR COMPONENTS**

QTY	ITEM	STOCK NUMBERS	DIMENSIONS (Inches)	WEIGHT (Lbs)
		(USA)		
1	Bag BG-72	6B32	13 x 11 x 8	8
1	Bag BG-73	6B33	36 x 5 dia with a side bag 8 x 6-1/2 x 3	3.4
1	Cord CD-332	3E1332	144 lg	.6
1	Key J-46	6B451	4 x 2 x 1	.2
1	Mount assembly (Ordnance Dept for aiming circle type M1916 and M1916M1)	6B583	5.3 x 1-1/2 dia	1
1	Signal Lamp M-132	6B692	10 x 5-1/2 dia	5.5
1	Tripod (Ordnance Dept type G for aiming circle type M1916)	6B1110	34 x 4 dia when folded	7.4

REFERENCE DATA AND LITERATURE:**SHIPPING DATA**

PKGS	VOLUME (Cu Ft)	WEIGHT (Lbs)
2	6	70

PROCUREMENT DATA

PROCURING SERVICE: USA
SPEC &/or DWG:

DESIGN COG: USA, Sig C

CONTRACTOR	LOCATION	CONTRACT OR ORDER NO.	APPROX UNIT COST

SIGNAL LAMP EQUIPMENT AN/PVC-type

20 November 1958

Cognizant Serv: USA FSN: 5850-407-6671

SE-11

	USA	USN	USAF
TYPE CLASS:	Std	--	--
STOCK NO:	6B841	--	--

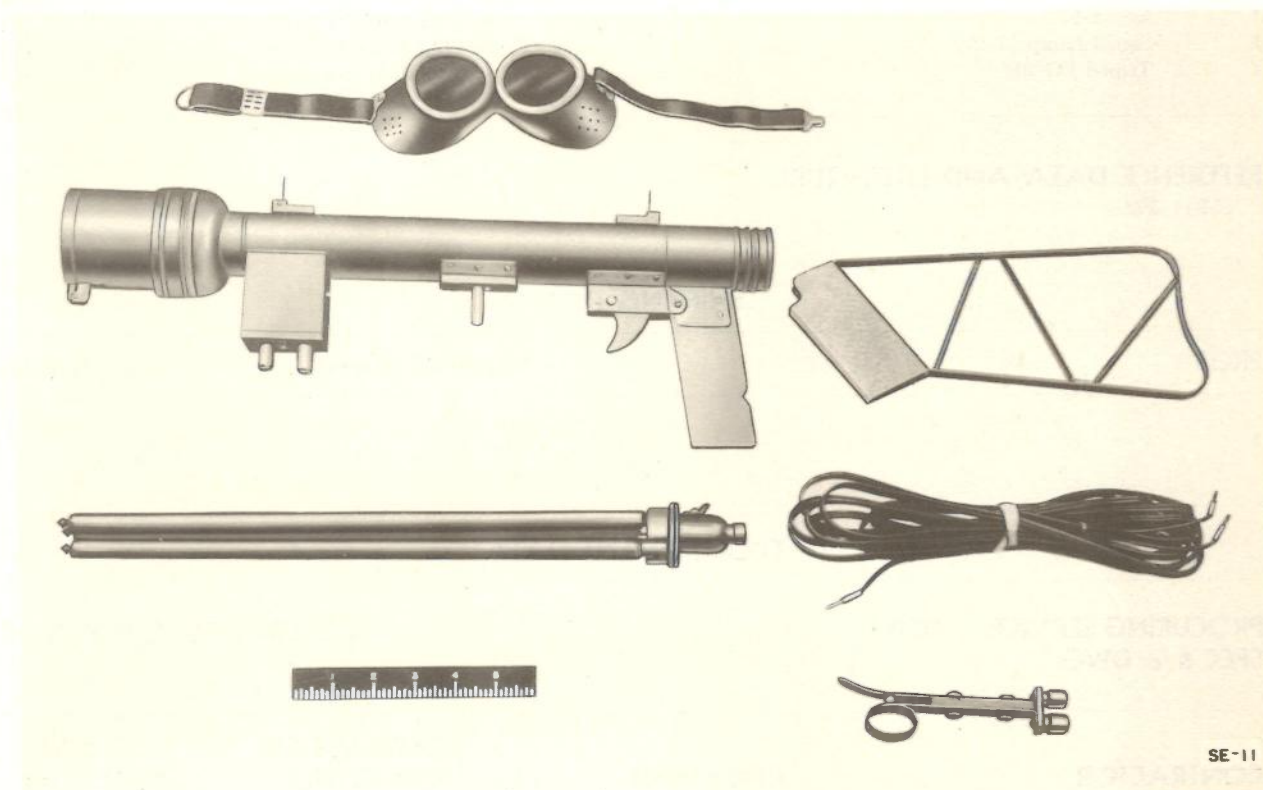

SE-11

FUNCTIONAL DESCRIPTION:

Signal Lamp Equipment SE-11 is a light-signaling device used for visual communication. It is used in traffic control and in forward area line-of-sight communication applications.

This equipment consists essentially of a signal lamp with a pistol grip and trigger-type on-off switch. A gunstock type of mounting is provided for operating the equipment from the shoulder. A tripod is included for use when the signal lamp is installed on the ground in relatively permanent applications. The tripod has a swivel head assembly and the equipment can be operated by remote control. Provision also is made for operation by a standard hand key when using International Morse Code. The lamp is equipped with sights similar to those

of a rifle and can be quickly trained on a given target. Goggles and filters are provided for reception of signals from similar equipment.

Signals of either white or red light can be selected by the operator.

TECHNICAL CHARACTERISTICS:

Type of Signal: Red or white light flashes

Approximate Range:

Day: 1-1/2 miles

Night: 5 miles

Controls: Self contained trigger or hand key

Power Requirements: 7.5-v dc from 5 Batteries BA-30 in series

MIL-HDBK-161

AN/PVC-type SIGNAL LAMP EQUIPMENT

MAJOR COMPONENTS—Continued

QTY	ITEM	STOCK NUMBERS	DIMENSIONS (Inches)	WEIGHT (Lbs)
1 (pr)	Filter MC-430			
1 (pr)	Goggles M-172	-----	8 x 2-3/4	0.3
1	Key J-51	-----	1-11/16 x 5-9/16 x 1/2	.1
1	Signal Lamp M-227	-----	18-1/2 x 6 x 1-3/4	2.1
1	Tripod LG-21	-----	42 extended; 18 collapsed	1.4

REFERENCE DATA AND LITERATURE:

TM 11-392

SHIPPING DATA

PKGS	VOLUME (Cu Ft)	WEIGHT (Lbs)
1	0.1	8.5

PROCUREMENT DATA

PROCURING SERVICE: USA
SPEC &/or DWG:

DESIGN COG: USA, Sig C

CONTRACTOR	LOCATION	CONTRACT OR ORDER NO.	APPROX UNIT COST
------------	----------	--------------------------	---------------------

TRANSMITTER-TELETYPEWRITER CONTROL **AN/SGA-type**

5 December 1958

Cognizant Serv: USN FSN: 5815-665-0929

C-492/SG

USA

USN

USAF

TYPE CLASS: --

Used by --

STOCK NO: --

F16-C-90148-2651 --

(No Illustration Available)

FUNCTIONAL DESCRIPTION:

Transmitter-Teletypewriter Control C-492/SG is intended for general shipboard installation. The unit controls associated radio transmitter power ON-OFF, controls associated radio transmitter carrier ON-OFF, and enables transfer of associated teletypewriter to send or receive.

Visual indications are provided by indicator lights on con-

trol panels. The control is designed to be mounted on the side of, or adjacent to, a send-receive teletypewriter; it may, however, be mounted on a bulkhead by means of a bracket.

TECHNICAL CHARACTERISTICS:

Power Requirements: Lamps powered through cabling of associated teletypewriter equipment

MAJOR COMPONENTS

QTY	ITEM	STOCK NUMBERS	DIMENSIONS (Inches)	WEIGHT (Lbs)
1	Transmitter-Teletypewriter Control C-492/SG (This equipment consists of only one major component.)	-----	8-3/4 x 5-1/2 x 4-1/2	3.25

REFERENCE DATA AND LITERATURE:

NAVSHIPS 91108

SHIPPING DATA

PKGS	VOLUME (Cu Ft)	WEIGHT (Lbs)
1	0.14	3.88

MIL-HDBK-161

AN/SGA-type TRANSMITTER-TELETYPEWRITER CONTROL

PROCUREMENT DATA

PROCURING SERVICE: USN
SPEC &/or DWG: RE-23F257B

DESIGN COG: USN, BuSt

CONTRACTOR	LOCATION	CONTRACT OR ORDER NO.	APPROX UNIT COS
Northeastern Engineering Inc.	Manchester, N. H.	NObsr-44205	\$35

KEYER AN/SGA-type

3 December 1958

Cognizant Serv: USN FSN: 5820-501-1954

KY-75/SRT

USA

USN

USAF

TYPE CLASS: Std

Used by

Used by

STOCK NO: --

F16-K-47672-9201

--

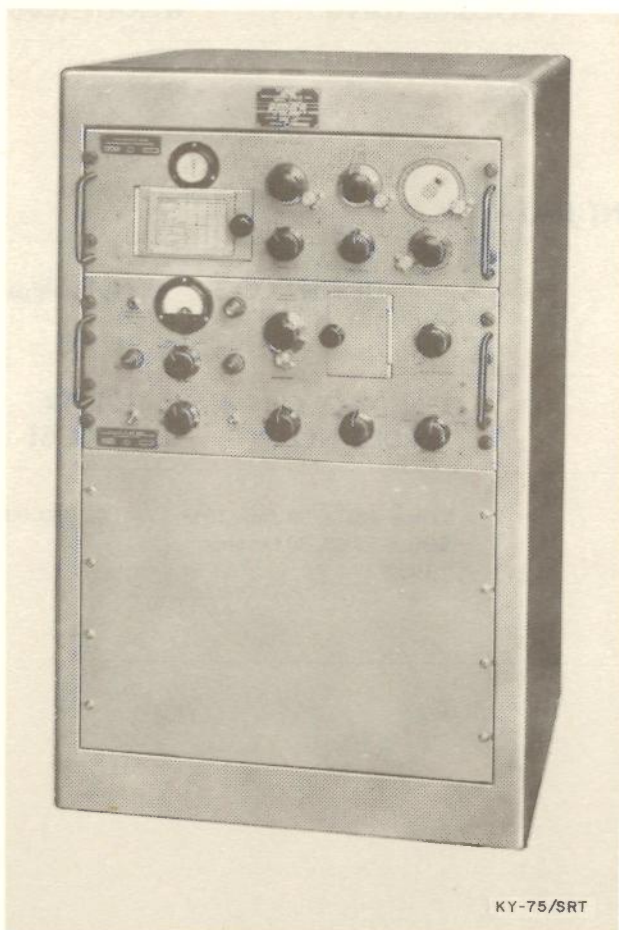
**FUNCTIONAL DESCRIPTION:**

Keyer KY-75/SRT is a frequency-shift keyer used in long distance radio telegraph systems to improve transmission. It replaces the exciter of a continuous wave transmitter with a source of excitation that can be shifted in frequency (a small value higher and lower) to produce telegraph or facsimile signals corresponding to those delivered to the transmitter input. This frequency-shift method is used to minimize selective fading, interference, and static disturbances.

This keyer can be connected to an external master oscillator (such as that of the associated transmitter) and provides three crystal-controlled channels.

Keyer KY-75/SRT is electrically and mechanically identical with Keyer KY-58/GRT that the KY-58/GRT is mounted on casters for mobility whereas the KY-75/SRT is not.

TECHNICAL CHARACTERISTICS:

Frequency Range in Mc: 1.0 to 6.7

Type Modulation: FM

Type of Signal: Frequency-shift keying, facsimile

Power Output: 6 w into 75-ohm load

Power Requirements: 470 w, 115/230-v 50/60-cycle 1-phase ac

MAJOR COMPONENTS

QTY	ITEM	STOCK NUMBERS	DIMENSIONS (Inches)	WEIGHT (Lbs)
1	Keyer KY-75/SRT (Equipment consists of only one major component.)	-----	24-1/2 x 22-1/8 x 26-9/16	220

MIL-HDBK-161

AN/SGA-type KEYER

REFERENCE DATA AND LITERATURE:

NAVSHIPS 91543

SHIPPING DATA

PKGS	VOLUME (Cu Ft)	WEIGHT (Lbs)
2	15.4	401

PROCUREMENT DATA

PROCURING SERVICE: USN
SPEC &/or DWG:

DESIGN COG: USN, BuShips

CONTRACTOR	LOCATION	CONTRACT OR ORDER NO.	APPROX UNIT COST
National Co. Inc.	Malden, Mass.	NObsr-42513, 30 June 1948 NObsr-52052, 30 October 1950	\$1,160.00

TELETYPE PANEL AN/SGA-type

21 October 1958

Cognizant Serv: USN FSN: TT-23/SG, 5815-302-5553
TT-23B/SG, 5815-372-5935

TT-23/SG, TT-23B/SG

USA

USN

USAF

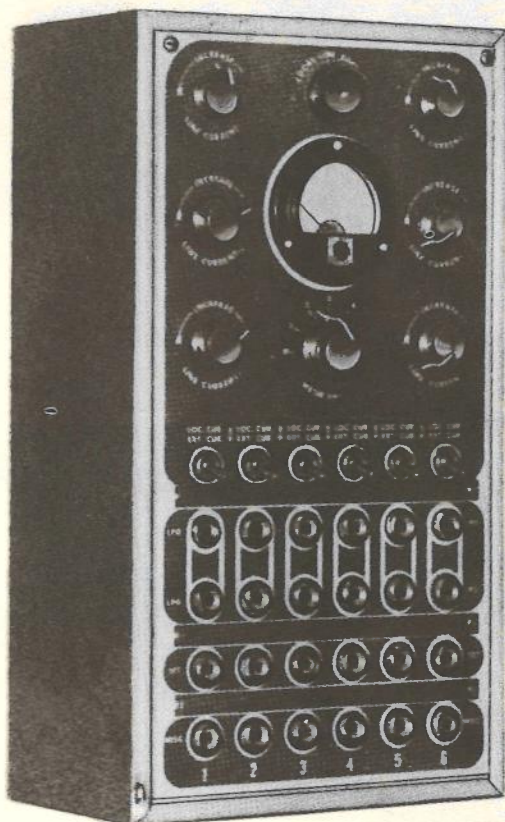
TYPE CLASS: --
STOCK NO: --Used by
TT-23/SG, F16-P-
1353-2
TT-23B/SG, F17-P-
23164-8867

TT-23B/SG

FUNCTIONAL DESCRIPTION:

Teletype Panels TT-23/SG and TT-23B/SG are small teletypewriter patch panels designed for general shipboard use to facilitate the interconnection and transfer of teletypewriter equipment with radio adapters, such as frequency-shift keyers and converters, and tone modulation terminal equipment.

Each panel has six channels. Each channel consists of a loop circuit of two loop jacks, one set jack, one miscellaneous jack, a rheostat for adjusting line current, and a toggle switch for selecting either a local or external source of line current. A meter measures line current on any channel. The miscellaneous jacks permit connection of any teletypewriter equipment not regularly assigned to a channel.

The TT-23/SG and TT-23B/SG are electrically and mechanically interchangeable. Minor differences between the models do not affect their application.

TECHNICAL CHARACTERISTICS:

Number of Circuits: 6 teletypewriter loop circuits

Current Range: 0 to 100 ma

Meter Range: 1 ma for full-scale deflection

Power Requirements: 100 ma (maximum) at 115-v dc

MIL-HDBK-161

AN/SGA-type TELETYPE PANEL

MAJOR COMPONENTS

QTY	ITEM	STOCK NUMBERS	DIMENSIONS (Inches)	WEIGHT (Lbs)
6	Dummy plug	-----	-----	0.02
6	Patch cord	-----	18 long	1.12
1	Teletype Panel TT-23/SG or TT-23B/SG	-----	14-5/8 x 8-1/4 x 5	12.5

REFERENCE DATA AND LITERATURE:

NAVSHIPS 91103

SHIPPING DATA

PKGS	VOLUME (Cu Ft)	WEIGHT (Lbs)
1	0.568	15

PROCUREMENT DATA

PROCURING SERVICE: USN
SPEC &/or DWG:

DESIGN COG: USN, BuShips

CONTRACTOR	LOCATION	CONTRACT OR ORDER NO.	APPROX UNIT COST
Northeastern Engineering, Inc.	Manchester, N. H.	NObar-39378	\$142 (TT- 23/SG)

RADIO TELETYPE TERMINAL SET **AN/SGC-1**

25 November 1958

Cognizant Serv: **USN** FSN: 5815-665-1330**USA****USN****USAF**

TYPE CLASS: --

Used by --

STOCK NO: --

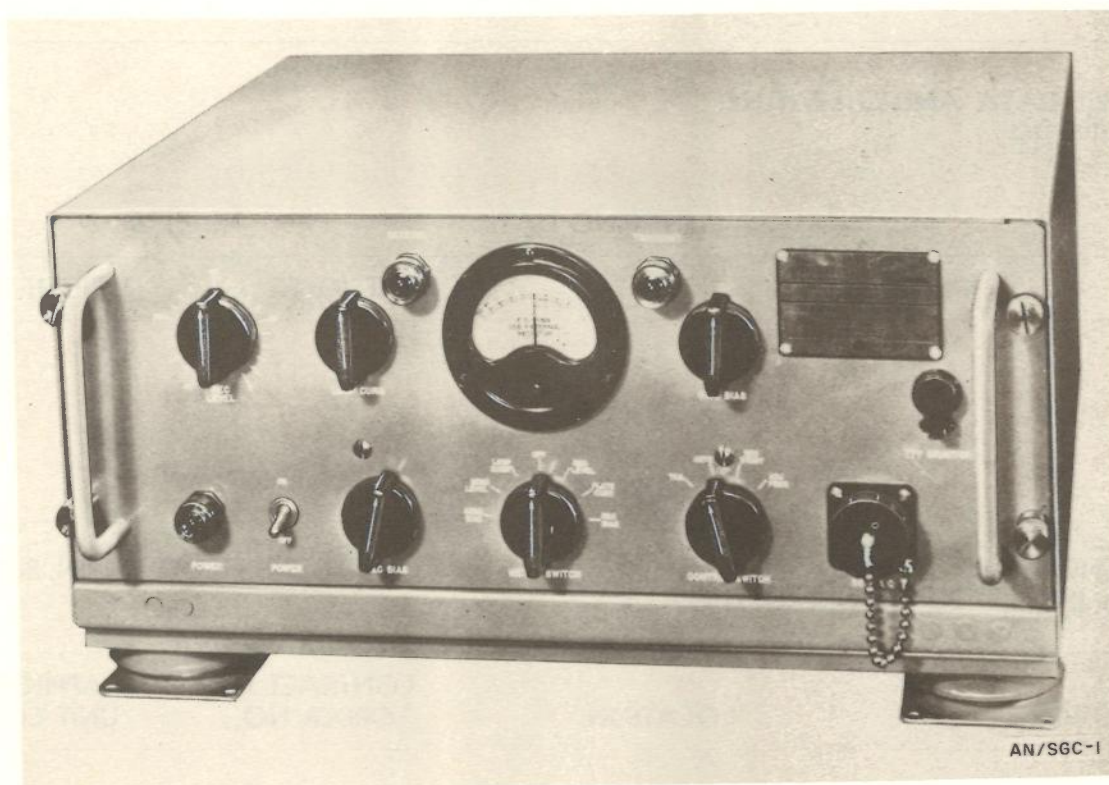
F16-Q-115092-200
(USN)**FUNCTIONAL DESCRIPTION:**

Radio Teletype Terminal Set AN/SGC-1 is used to transmit and receive teletypewriter messages over radio channels between stations similarly equipped.

The terminal set, when transmitting, converts the current pulses from the teletypewriter to audio tones which modulate the radio transmitter. When receiving, the set converts the tones to make-and-break signals for operating the associated teletypewriter.

TECHNICAL CHARACTERISTICS:

Frequency Range: .5 kc and .7 kc
Type Emission and Reception: A3 (cw)
Minimum Input Signal Level: -40 dbm
Maximum Output Power: +10 dbm
Output Impedance: 600 ohms or 50 ohms
Input Impedance: 600 ohms
Heat Dissipation: 117 w
Power Requirements: 86 w, 115-v 50- to 60-cycle 1-phase ac

MIL-HDBK-161

AN/SGC-1 RADIO TELETYPE TERMINAL SET

MAJOR COMPONENTS

QTY	ITEM	STOCK NUMBERS	DIMENSIONS (Inches)	WEIGHT (Lbs)
1 set	Equipment spares	-----	6-1/8 x 19-1/8 x 16	49
1	Teletypewriter Terminal TT-40/SGC-1	-----	9-11/16 x 19-1/4 x 17-9/16	50

REFERENCE DATA AND LITERATURE:

NAVSHIPS 91152

SHIPPING DATA

PKGS	VOLUME (Cu Ft)	WEIGHT (Lbs)
1	6.1	148

PROCUREMENT DATA

PROCURING SERVICE: USN

DESIGN COG: USN, BuShips

SPEC &/or DWG: CS-703; MIL-R-1510

CONTRACTOR	LOCATION	CONTRACT OR ORDER NO.	APPROX UNIT COST
Remler Co., Ltd.	San Francisco, Calif.	NObsr-39323, 26 June 1947	\$650.00

RADIO TELETYPE TERMINAL SET **AN/SGC-1A**

25 November 1958

Cognizant Serv: USN FSN: 5815-665-1329

	USA	USN	USAF
TYPE CLASS:	--	Used by	--
STOCK NO:	--	F16-Q-115096-200 (USN)	--

(No Illustration Available)

FUNCTIONAL DESCRIPTION:

Radio Teletype Terminal Set AN/SGC-1A is a terminal for teletypewriter communications, making possible the transmission and reception of teletypewriter messages by radio equipment.

When transmitting, the terminal set converts the current pulses from the teletypewriter to audio tones for modulating the transmitter.

When the set is receiving, teletypewriter transmissions are demodulated so as to facilitate operation of the associated teletypewriter.

This equipment is the same as Radio Teletype Terminal

Set AN-SGC-1 in size, weight, operation, installation, and external connection. However, the AN/SGC-1A chassis is not interchangeable with the chassis of the AN/SGC-1.

TECHNICAL CHARACTERISTICS:

Frequency Range: 0.5 kc and 0.7 kc

Type Emission and Reception: A1

Minimum Signal Input: -40 dbm

Maximum Signal Output: +10 dbm

Input Impedance: 600 ohms

Output Impedance: 600 ohms or 50 ohms

Power Requirements: 86 w, 115-v 50- to 60-cycle 1-phase ac

MAJOR COMPONENTS

QTY	ITEM	STOCK NUMBERS	DIMENSIONS (Inches)	WEIGHT (Lbs)
1	Set of equipment spares	-----	6-1/8 x 12-13/16 x 10-1/2	27
1	Teletypewriter Terminal TT-40A/SGC-1	-----	9-11/16 x 19-1/4 x 17-9/16	50

REFERENCE DATA AND LITERATURE:

NAVSHIPS 91503

SHIPPING DATA

PKGS	VOLUME (Cu Ft)	WEIGHT (Lbs)
1	6.1	130

MIL-HDBK-161

AN/SGC-1A RADIO TELETYPE TERMINAL SET

PROCUREMENT DATA

PROCURING SERVICE: USN
SPEC &/or DWG:

DESIGN COG: USN, BuShips

CONTRACTOR	LOCATION	CONTRACT OR ORDER NO.	APPROX UNIT COST
Remler Co., Ltd.	San Francisco, Calif.	NObsr-52077, 17 November 1950	

AMPLIFIER-OSCILLATOR GROUP AN/SIA-1

25 November 1958

Cognizant Serv: USN FSN:

	USA	USN	USAF
TYPE CLASS:	--	Used by	--
STOCK NO:	--	--	--

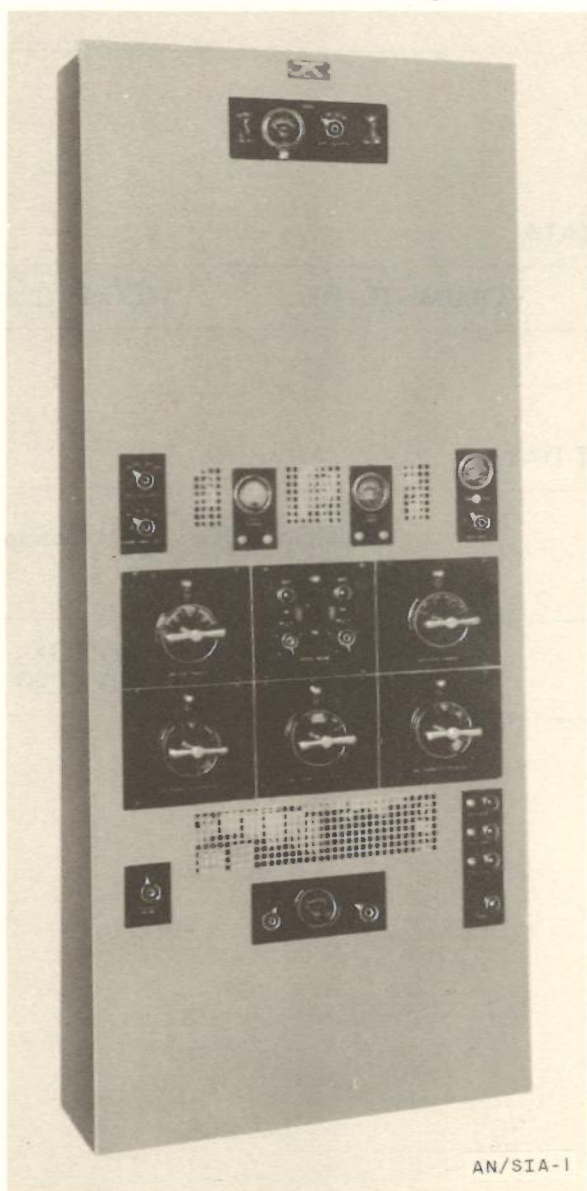

AN/SIA-1

FUNCTIONAL DESCRIPTION:

Amplifier-Oscillator Group AN/SIA-1 is designed to control general alarm as well as chemical attack alarm signals and to amplify audio signals. It is part of Navy Battle Announcing Equipment Type MCG.

This equipment consists of a preliminary amplifier and two oscillators mounted in a cabinet. The front panel of the cabinet provides various control and indicating devices.

The group requires transmitter control stations and reproducers in quantities determined by a given situation. However, these items are not furnished as part of the equipment.

TECHNICAL CHARACTERISTICS:

Power Requirements: 115-v 60-cycle 1-phase ac

AMPLIFIER-OSCILLATOR GROUP AN/SIA-3

25 November 1958

Cognizant Serv: USN FSN:

	USA	USN	USAF
TYPE CLASS:	--	Used by	--
STOCK NO:	--	--	--

(No Illustration Available)

FUNCTIONAL DESCRIPTION:

Amplifier-Oscillator Group AN/SIA-3 provides general announcing facilities for a 1-mc circuit and submarine control announcing for a 7-mc circuit. It is used for disseminating orders and information from the various control stations, strategically located throughout the submarine, to all other parts of the vessel where the 1-mc or 7-mc loudspeakers are employed.

TECHNICAL CHARACTERISTICS:

Audio Frequency Amplifier:

Frequency Response: ± 1 db at 300 cps to 3,000 cps
 Amplifier Gain: 119 db maximum

Input Impedance: 75 ohms at 150 ohms at 1,000 cps

Output Impedance: 39 ohms at 1,000 cps

Power Output: 125 w at 5% distortion

Alarm Signal Generator:

Collision Alarm: 750-cps to 1,750-cps siren; 3-sec full sweep

Dining Alarm: Simulated motor-operated horn

General Alarm: Simulated bell; 90 strokes per minute

Voltage Output: 10 v rms

Output Impedance: 500 ohms

Power Requirements:

Standby: 230 w, 115-v 60-cycle 1-phase ac, 2.0 amp

Ready: 1,250 w, 115-v 60-cycle 1-phase ac, 11.0 amp

MAJOR COMPONENTS

QTY	ITEM	STOCK NUMBERS	DIMENSIONS (Inches)	WEIGHT (Lbs)
(*)	Amplifier and Control Rack 1C/SAA	-----	15 x 20 x 16-3/4	750
	Handset 1C/MPH	-----	2-3/4 x 3-1/2 x 9-1/2	4.5
	Loudspeaker L-S	-----	5 x 8 x 12	23
	Loudspeaker Fixed Volume Control 1C/SXV	-----	3-1/4 x 4-7/16 x 4-7/16	4.5
	Low Power Loudspeaker 1C/SAA	-----	8-1/2 x 11 x 11	15
	Microphone Control Box 1C/MBA	-----	4-1/2 x 5-5/8 x 5-5/8	5
	Microphone Jack Box 1C/MJB	-----	4 x 4-1/2 x 4-1/2	4.5
	Microphone with Flexible Mounting 1C/MFM	-----	3-1/2 x 4-1/2 x 39	5.5
	Portable Microphone 1C/MPM	-----	2-3/4 x 5-1/4 x 11	5
	Pressure Proof Loudspeaker 1C/SHA	-----	5 x 6 x 6	13
	Pressure Proof Talk Switch 1MC/7MC	-----		

* Quantity as required per installation.

MIL-HDBK-161

AN/SIA-3 AMPLIFIER-OSCILLATOR GROUP

REFERENCE DATA AND LITERATURE:
NAVSHIPS 365-1864

SHIPPING DATA

PKGS	VOLUME (Cu Ft)	WEIGHT (Lbs)
------	----------------	--------------

PROCUREMENT DATA

PROCURING SERVICE: USN
SPEC &/or DWG:

DESIGN COG: USN, BuShips

CONTRACTOR	LOCATION	CONTRACT OR ORDER NO.	APPROX UNIT COST
Remler Co., Ltd.	San Francisco, Calif.	NObsr-47705	

AMPLIFIER-OSCILLATOR GROUP AN/SIA-10

25 November 1958

Cognizant Serv: USN FSN:

	USA	USN	USAF
TYPE CLASS:	--	Used by	--
STOCK NO:	--	--	--

(No Illustration Available)

FUNCTIONAL DESCRIPTION:

Amplifier-Oscillator Group AN/SIA-10 provides amplified voice and alarm signals which are heard from reproducers located in various parts of the ship. Further, it amplifies voice and command signals originating from selected gun station reproducers located in the gun mounts.

This equipment consists essentially of a general announcing system and an aircraft announcing system.

TECHNICAL CHARACTERISTICS:

Voltage Amplifier N-201-3: Contains compressor and limiter circuits and its own power supply

Power Amplifier N-202-3: Consists of a single-stage, high-power class B audio amplifier using 4 type 811 tubes in push-pull parallel

Control Panel Assembly N-262-3: Consists of relays, switches, volume indicator, load resistors, fuses, terminals, relay power transformers associated with the system

Alarm Signal Generator N-214-2: Consists of an oscillator-amplifier, a power transformer with rectifier and filter circuit, 4 control relays, and a motor driven cam-operated switch, all mounted on a common chassis

Transmitter Control Station N-251: Encased in metal housing

which is mounted on the ship's bulkhead. On the unit control panel are mounted the busy lights, the reproducer-group selector switches, the press-to-talk switch, a shock-mounted volume-indicating meter, and a microphone

Portable Microphone N-253-3: Consists of the microphone motor, the press-to-talk switch, a resistor-condenser equalizing pad, and the microphone housing. An antifeed-back mouthpiece is secured to the housing with a clamping ring which also retains the motor assembly in the housing

Amplifier Cabinet Assembly N-254-3: Consists of (1) Voltage Amplifier N-201-3, (1) salvo and cease firing Signal Generator N-217, (1) Control and Test Panel N-287-1

Command Signal Generator N-217-1: Consists of a vacuum-tube oscillator-amplifier with power supply, relays, and motor-driven variable condenser

Control Box, Class "E" N-290-6: Consists of a shock-mounted volume indicator, a portable microphone receptacle with protecting cap and locking-type press-to-talk switch

Reproducers N-256 and N-257: Differ only in that they employ different transformers to obtain different levels of output

Reproducer N-259: Permanent-magnet type and of direct radiator construction

Power Requirements: 115-v ac

MAJOR COMPONENTS

QTY	ITEM	STOCK NUMBERS	DIMENSIONS (Inches)	WEIGHT (Lbs)
1	Amplifier and Control Panel Assembly N-254-3	-----	16-7/8 x 26 x 29	265
1	Amplifier and Control Panel Assembly N-289-4	-----	20 x 30 x 72	1,175
1	Circuit Analyzer N-209-1	-----		13.5
1	Control Box, Class "E" N-290-6	-----	6-1/2 x 9-1/4 x 11-3/4	22
2	Portable Microphone Transmitter N-253-3	-----		5
7	Reproducer, Class H, Grade I and II, N-256	-----	10-1/2 x 12-5/8 x 15-1/2	49
50	Reproducer, Class L, Grade I, N-259	-----	5-3/4 x 8-5/8 x 12	23
10	Reproducer, Class M, Grade I and II, N-257	-----	10-1/2 x 12-5/8 x 15-1/2	49

MIL-HDBK-161

AN/SIA-10 AMPLIFIER-OSCILLATOR GROUP

MAJOR COMPONENTS—Continued

QTY	ITEM	STOCK NUMBERS	DIMENSIONS (Inches)	WEIGHT (Lbs)
1	Set of Spare Parts N-208-6	-----	-----	943
2	Transmitter Control Station, Class A, N-251-16	-----	8-1/2 x 12-1/2 x 15-7/8	48
2	Transmitter Control Station, Class A, N-251-17	-----	8-1/2 x 12-1/2 x 15-7/8	48

REFERENCE DATA AND LITERATURE:

Commercial literature IC-30W

SHIPPING DATA

PKGS	VOLUME (Cu Ft)	WEIGHT (Lbs)
------	----------------	--------------

PROCUREMENT DATA

PROCURING SERVICE: USN
SPEC &/or DWG:

DESIGN COG: USN, BuShips

CONTRACTOR	LOCATION	CONTRACT OR ORDER NO.	APPROX UNIT COST
Remler Co., Ltd.	San Francisco, Calif.	NObsr-11185 NObsr-11761-Lot II	

AMPLIFIER-CONTROL GROUP **AN/SIA-35**

1 December 1958

Cognizant Serv: USN FSN:

USA

USN

USAF

TYPE CLASS: --

Used by

--

STOCK NO: --

--

--

(No Illustration Available)

FUNCTIONAL DESCRIPTION:

Amplifier Control-Group AN/SIA-35 is a shipborne battle announcing system that provides voice communication among microphones located at various positions on the vessel, and among groups of reproducers located throughout the ship.

This equipment also provides for the reproduction of electronically generated alarm signals that simulate klaxon siren and gong signals. The transmitter stations of the system permit the use of fixed, portable, or throat microphones except in torpedo rooms where only throat microphones can be used.

Pressure-proof boxes are provided for protection against submersion.

TECHNICAL CHARACTERISTICS:*Signal Generator:*

Power Consumption:

Standby: 82 w*Operating:* 92 w

Heat Dissipation: 92 w

Power Output: 10 w

Voltage Amplifier:

Power Input:

Standby: 80 w*Ready:* 271 w

Heat Dissipation:

Standby: 80 w*Ready:* 191 w

Distortion: 10% at full load

Power Consumption:

Standby: 232 w

Operating: 634 w

Power Output: 160 w*Heat Dissipation:* 474 w*Power Requirements:* 115 v 60-cycle**MAJOR COMPONENTS**

QTY	ITEM	STOCK NUMBERS	DIMENSIONS (Inches)	WEIGHT (Lbs)
1	Control panel			
2	Power amplifier			
2	Signal generator			

REFERENCE DATA AND LITERATURE:

NAVSHIPS 365-0222

SHIPPING DATA

PKGS	VOLUME (Cu Ft)	WEIGHT (Lbs)

MIL-HDBK-161

AN/SIA-35 AMPLIFIER-CONTROL GROUP

PROCUREMENT DATA

PROCURING SERVICE: USN
SPEC &/or DWG:

DESIGN COG: USN, BuShips

CONTRACTOR	LOCATION	CONTRACT OR ORDER NO.	APPROX UNIT COST
Guided Radio Corp.	New York, N. Y.	NOs-88797	

AMPLIFIER-CONTROL GROUP AN/SIA-61

1 December 1958

Cognizant Serv: USN FSN:

	USA	USN	USAF
TYPE CLASS:	--	Used by	--
STOCK NO:	--	--	--

(No Illustration Available)

FUNCTIONAL DESCRIPTION:

Amplifier-Control Group AN/SIA-6 is designed to transmit, amplify, and reproduce speech and tone signals on shipboard.

The number of transmitter control stations, signal generators, amplifiers, and reproducers employed on any particular system is determined by the requirements and extent of the installation.

TECHNICAL CHARACTERISTICS:

Amplifier Rack (Circuit IMC): Provides 2-channel amplifier rack with facilities for housing 4 voltage amplifiers, 2 signal generators, 1 control panel. Each of the 2 amplifier channels comprises 2 voltage amplifiers connected in parallel.

Amplifier Rack (Lifeboat Talk-Back Circuit): Comprises a cabinet in which is mounted 1 control panel, 1 voltage amplifier with compressor

Portable Transmitter: Comprises a magnetic microphone with a talk switch supported by neck band; includes 20-ft. cable

Reproducers (High and Medium Power): High and low power reproducers are alike in all construction details with exception of volume control switch and resistor; diaphragm has 15-ohm voice coil.

Reproducers (Low and Standard Power): Contained within 2-section circular brass mounting; permanent-magnet-field dynamic type

Signal Generator (Type B): Produce bell tone signal for general alarm and various audio frequencies for alarm or command signals. Signals also used for test purposes

Transmitter Control Station (Class A): Comprises magnetic type microphone, volume indicating meter, switch, and indicating lamps

Voltage Amplifier: Consists of 3 stages of amplification together with rectifier tubes that supply dc plate power for voltage amplifier and compressor

Compressor: Consists of one-stage amplification and 2 separate signal rectifier stages

Heat Dissipation (Maximum):

Standby: 285 w with talk-back amp off; 527 w with talk-back amp on

Ready: 1,057 w with talk-back amp off; 1,360 w with talk-back amp on

Power Requirements:

Standby: 285 w, 93 pf, lagging with talk-back amp off; 527 w, 93 pf, lagging with talk-back amp on

Ready: 1,137 w, 87.5 pf, lagging with talk-back amp off; 1,430 w, 87.5 pf, lagging with talk-back amp on

MAJOR COMPONENTS

QTY	ITEM	STOCK NUMBERS	DIMENSIONS (Inches)	WEIGHT (Lbs)
1	Amplifier Rack MI-2783	-----	14 x 24 x 29-5/8	200
1	Amplifier Rack MI-2784	-----	14 x 21-3/8 x 72	555
1	Circuit Tester MI-2657	-----	5-1/2 x 12-3/4 x 13	13.5
10	Portable Transmitter MI-2162-A	-----	4-3/8 x 5-1/2 x 12	5.5
2	Reproducer, Class H MI-2916-A	-----	13-3/4 x 17-1/8 x 18	36
62	Reproducer, Class L MI-2917-J	-----	5 x 10 x 10-3/4	19
16	Reproducer, Class M M-2915-A	-----	13-3/4 x 17-1/8 x 18	36
1	Set of Spare Parts and Tools W-130307	-----		
2	Set of Tubes MI-2646	-----		

AN/SIA-61 AMPLIFIER-CONTROL GROUP

MAJOR COMPONENTS—Continued

QTY	ITEM	STOCK NUMBERS	DIMENSIONS (Inches)	WEIGHT (Lbs)
2	Set of Tubes MI-2647			
8	Talk Back Switch MI-2859-B	-----	5-1/2 x 7 x 7-1/2	
1	Transmitter Control Station, Class A, MI-2192-1	-----	10-1/4 x 12-1/8 x 16-1/2	3
2	Transmitter Control Station, Class A, MI-2192-5	-----	10-1/4 x 12-1/8 x 16-1/2	3.

REFERENCE DATA AND LITERATURE:

Commercial literature, Instruction Book No. 27H3

SHIPPING DATA

PKGS	VOLUME (Cu Ft)	WEIGHT (Lb)
------	----------------	-------------

PROCUREMENT DATA

PROCURING SERVICE: USN
SPEC &/or DWG:

DESIGN COG: USN, BuShi

CONTRACTOR	LOCATION	CONTRACT OR ORDER NO.	APPROX UNIT COST
Radio Corp. of America Manufacturing Co., Inc.	Camden, N. J.	NOs 94132	

AMPLIFIER-CONTROL GROUP AN/SIA-62

1 December 1958

Cognizant Serv: USN FSN:

USA

USN

USAF

TYPE CLASS: --

Used by --

STOCK NO: --

(No Illustration Available)

FUNCTIONAL DESCRIPTION:

Amplifier-Control Group AN/SIA-62 is a voice and tone transmitting, generating, amplifying, and reproducing equipment. It is designed for shipboard installation.

This equipment consists essentially of a rack containing a two-channel amplifier, a control panel, and two signal generators. Each of the two amplifier channels is composed of two voltage amplifiers connected in parallel.

The system is used to amplify and control voice communications to and from reproducers and transmitters located at

various stations aboard ship. It is also used to generate general and chemical alarm signals.

In conjunction with a portable transmitter, two transmitter control stations, and reproducers as required, this equipment forms general announcing system (circuit 1 MC) of the Navy Battle Announcing Equipment Type MCG.

The amplifier is identical with the commercial Radio Corporation of America Model No. MI-2722-A.

TECHNICAL CHARACTERISTICS:

Information not available

MAJOR COMPONENTS

QTY	ITEM	STOCK NUMBERS	DIMENSIONS (Inches)	WEIGHT (Lbs)
1	Amplifier Rack 1-MC			
1	Control panel			
2	Signal Generator MI-2871			
1	Voltage Amplifier MI-2877A			

REFERENCE DATA AND LITERATURE:

Commercial literature, Instruction Book No. 27W; IB-38673

SHIPPING DATA

PKGS	VOLUME (Cu Ft)	WEIGHT (Lbs)

MIL-HDBK-161

AN/SIA-62 AMPLIFIER-CONTROL GROUP

PROCUREMENT DATA

PROCURING SERVICE: USN
SPEC &/or DWG:

DESIGN COG: USN, BuShips

CONTRACTOR	LOCATION	CONTRACT OR ORDER NO.	APPROX UNIT COST
Radio Corp. of America	Camden, N. J.	78790 81910	

CONTROL-OSCILLATOR GROUP AN/SIA-66

1 December 1958

Cognizant Serv: USN FSN:

	USA	USN	USAF
TYPE CLASS:	--	Used by	--
STOCK NO:	--	--	--

(No Illustration Available)

FUNCTIONAL DESCRIPTION:

Control-Oscillator Group AN/SIA-66 is a battle announcing equipment designed for transmitting, amplifying, and reproducing speech and alarm signals on shipboard.

The number of transmitters, control boxes, signal generators, amplifier units, and reproducers employed as part of any particular system is determined by the requirements and the extent of the installation.

TECHNICAL CHARACTERISTICS:

Amplifier:

Output: 140 w

Input: 64 ohms

Input of Reproducer, Class H: 95 v*Input of Reproducer, Class M:* 95 v*Input of Reproducer, Class L:* 95 v*Dc Resistance of Reproducer, Class BM:* 14.5 ohms*Headset:*

Type: Permanent magnet

Dc Resistance: 2,200 ohms

Power Requirements: 115-v 60-cycle 1-phase ac

MAJOR COMPONENTS

QTY	ITEM	STOCK NUMBERS	DIMENSIONS (Inches)	WEIGHT (Lbs)
1	Amplifier MCG-MCA	-----	18 x 30 x 72	1,000
1	Control Box, Class D	-----	5-1/2 x 8-1/2 x 11-1/8	16
1	Headset	-----	4 x 6 x 6	3
1	Jack box	-----	3-1/8 x 4-11/16 x 6-3/16	2
1	Portable transmitter	-----	4-1/2 x 5-1/2 x 12	4
1	Reproducer, Class BM	-----	24 x 26 x 37	283
(*)	Reproducer, Class H	-----	8-3/4 x 12-3/4 x 12-3/4	25
(*)	Reproducer, Class L	-----	7-1/2 x 9-1/16 x 9-1/16	12
(*)	Reproducer, Class M	-----	8-3/4 x 12-3/4 x 12-3/4	25
(*)	Reproducer, Class S	-----	7-1/2 x 9-1/16 x 9-1/16	12
1	Set of spare parts and tool and test equipment	-----		
1	Transmitter, Class A	-----	9 x 14-7/8 x 19-1/8	35
(*)	Quantities as required per vessel			

* Determined by the requirements and the extent of the installation.

REFERENCE DATA AND LITERATURE:

NAVSHIPS 365-0063

MIL-HDBK-161

AN/SIA-66 CONTROL-OSCILLATOR GROUP

SHIPPING DATA

PKGS	VOLUME (Cu Ft)	WEIGHT (Lbs)
------	----------------	--------------

PROCUREMENT DATA

PROCURING SERVICE: USN
SPEC &/or DWG:

DESIGN COG: USN, BuShips

CONTRACTOR	LOCATION	CONTRACT OR ORDER NO.	APPROX UNIT COST
Stromberg-Carlson Co.	Rochester, N. Y.	NObsr-11477	

1 December 1958

Cognizant Serv: USN FSN:

USA

USN

USAF

TYPE CLASS: --

Used by

--

STOCK NO: --

--

--

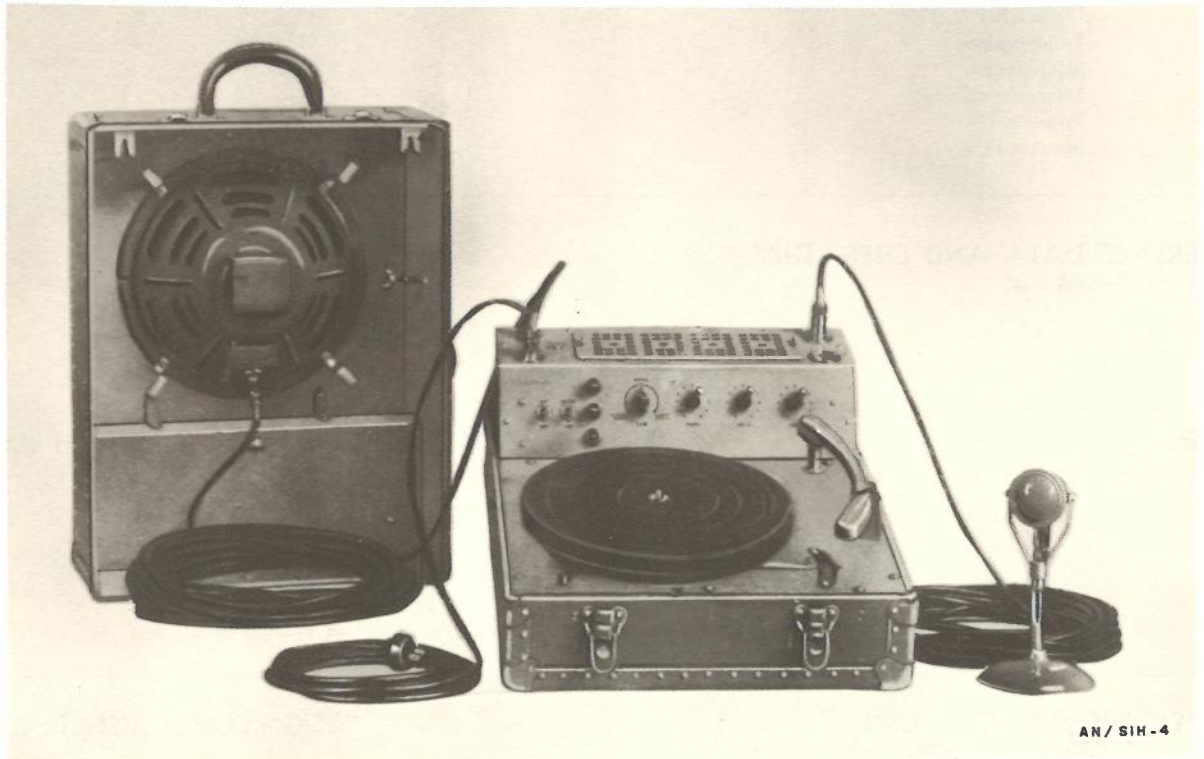

AN/SIH-4

FUNCTIONAL DESCRIPTION:

Public Address Set AN/SIH-4 is a portable, self-contained transcription reproducer and public address system.

This equipment is used to reproduce standard recording disks up to and including 16 inches in diameter that have been recorded at speeds of 33-1/3 or 78 revolutions per minute.

Reproducing speeds adjustable to accommodate variations in line frequency or voltage, or both.

The set will also produce long playing or microgroove records if the proper needle is substituted in the reproducer head.

TECHNICAL CHARACTERISTICS:

Input Facilities: Microphone 1, microphone 2, low level, and photograph (variable reluctance pick-up)

Input Impedance:

Microphone 1: 150 ohms

Microphone 2: 150 ohms

Low Level: 35,000 ohms

Phonograph Pick-up: 150,000 ohms

Input Voltage Limits:

Microphone 1: 800 uv to 45,000 uv rms

Microphone 2: 800 uv to 45,000 uv rms

Low Level: 2.5 v to 4 v rms

Photograph: 30 mv to 360 mv rms

Output Facilities: Speaker and low level

Output Impedance:

Speaker: 8 ohms

Low Level: 35,000 ohms

Power Output:

Speaker: 10 w

Low Level: 4 v rms

Reproducing Speed: 78 rpm and 33-1/3 rpm

Type of Recordings: Will reproduce all laterally cut records and transcriptions, cut either outside-in or inside-out; and with the proper needle will reproduce microgroove recordings

Power Consumption: 100 w

Power Requirements: 108- to 122-v, 55- to 65-cycle, 1-phase ac

MIL-HDBK-161

AN/SIH-4 PUBLIC ADDRESS SET

MAJOR COMPONENTS

QTY	ITEM	STOCK NUMBERS	DIMENSIONS (Inches)	WEIGHT (Lbs)
1	Carrying case consisting of: Amplifier and turntable assembly Loudspeaker Microphone Microphone cable Power cable Speaker cable	-----	12-1/4 x 17-1/2 x 23-1/2	51

REFERENCE DATA AND LITERATURE:

NAVSHIPS 365-1947

SHIPPING DATA

PKGS	VOLUME (Cu Ft)	WEIGHT (Lbs)
1	5.15	86

PROCUREMENT DATA

PROCURING SERVICE: USN
SPEC &/or DWG: SHIPS-R-29

DESIGN COG: USN, BuShips

CONTRACTOR	LOCATION	CONTRACT OR ORDER NO.	APPROX UNIT COST
Mark Simpson Manufacturing Co., Inc.	Long Island City, New York, N. Y.	NObsr-50563, March 1951	

PUBLIC ADDRESS SET **AN/SIH-6**

1 December 1958

Cognizant Serv: USN FSN:

USA

USN

USAF

TYPE CLASS: --

Used by --

STOCK NO: --

(No Illustration Available)

FUNCTIONAL DESCRIPTION:

Public Address Set AN/SIH-6 is an electrical amplification system designed to serve audiences by amplifying record player data.

TECHNICAL CHARACTERISTICS:

*Power Output: 55 w**Power Requirements: 115-v 60-cycle 1-phase ac*

MAJOR COMPONENTS

QTY	ITEM	STOCK NUMBERS	DIMENSIONS (Inches)	WEIGHT (Lbs)
1	Amplifier, audio frequency			
1	Loudspeaker, permanent magnet			
1	Record player			

REFERENCE DATA AND LITERATURE:

SHIPPING DATA

PKGS	VOLUME (Cu Ft)	WEIGHT (Lbs)

MIL-HDBK-161

AN/SIH-6 PUBLIC ADDRESS SET

PROCUREMENT DATA

PROCURING SERVICE: USN
SPEC &/or DWG: MIL-P-16790

DESIGN COG: USN, BuShips

CONTRACTOR	LOCATION	CONTRACT OR ORDER NO.	APPROX UNIT COST
Bowen and Co., Incorporated	Bethesda 14, Md.	NObsr-67052, 20 June 1955	

6 December 1958

Cognizant Serv: USA FSN: 5830-163-1796

USA

USN

USAF

TYPE CLASS: L/Std
 STOCK NO: 6C197-1

--

--

--

--



AN/SIQ-1

FUNCTIONAL DESCRIPTION:

Public Address Set AN/SIQ-1 is a medium-power, sound amplifying and projecting equipment used for briefing, training, or morale purposes. It is designed primarily for shipboard use but can also be used in outdoor or indoor auditoriums.

This equipment consists essentially of a combined two-speed phonograph turntable and audio amplifier, microphones, speakers, and related accessories. It is so arranged that the entire equipment can be packed into seven carrying cases, each of which can be carried by two men.

Sound signals, whether speech or music, are picked up by means of the microphones or by means of the sound reproducer. There is no provision for input from wire communication or radio receiving equipment.

TECHNICAL CHARACTERISTICS:*Sound Reproducer:*

Amplifier Output: 50 w

Type Reproduction: Magnetic
 Recording Sizes Accepted: 10 inch, 12 inch, 16 inch
 Revolutions per Minute: 33-1/3 or 78

Dynamic Microphone:

Type: Unidirectional
 Impedance: 30 to 50 ohms

Dynamic Speaker:

Type: Diaphragm
 Input: 20 w
 Impedance: 150 ohms

Amplifier:

1 Channel Input Impedance: 30 ohms
 Output Impedance: 4, 8, 30, 60, 125, 150, 500 ohms

Microphone Stand:

Type: Adjustable
 Dimensions: From 35 inches to 5 feet 8 inches

Motor Generator Input: 4.4 amp, 115-v 60-cycle 1-phase ac;
 550 w, 5 amp at 100-v dc

Power Requirements: 250 w, 115-v 60-cycle 1-phase ac, or
 250 w, 115-v dc through converter

MIL-HDBK-161

AN/SIQ-1 PUBLIC ADDRESS SET

MAJOR COMPONENTS

QTY	ITEM	STOCK NUMBERS	DIMENSIONS (Inches)	WEIGHT (Lbs)
		(FSN)		
8	Cable assembly, special purpose, electrical	5995-162-9891	100 feet 2-1/2 inches	
2	Cable assembly, special purpose, electrical	5995-284-4164	100 feet	
2	Microphone, dynamic	5965-164-7294	4-13/16 x 2-5/8 x 2	
1	Motor generator	6125-240-0781	13-1/2 x 7-13/16 x 7-13/16	
1	Reproducer, sound	5835-164-7247		
4	Speaker, dynamic	5965-164-7263	24-1/2 dia x 31 long	
2	Stand, microphone	5965-162-1315	35 inches to 5 feet 8 inches	

REFERENCE DATA AND LITERATURE:

TM 11-2577

SHIPPING DATA

PKGS	VOLUME (Cu Ft)	WEIGHT (Lbs)
7	59.3	536

PROCUREMENT DATA

PROCURING SERVICE: USA
SPEC &/or DWG:

DESIGN COG: USA, Sig C

CONTRACTOR	LOCATION	CONTRACT OR ORDER NO.	APPROX UNIT COST
------------	----------	--------------------------	---------------------

SOUND RECORDER-REPRODUCER SET AN/SNH-1

1 December 1958

Cognizant Serv: USN FSN:

USA

USN

USAF

TYPE CLASS: --

Used by --

STOCK NO: --

(No Illustration Available)

FUNCTIONAL DESCRIPTION:

Sound Recorder-Reproducer Set AN/SNH-1 is a electromagnetic type equipment designed for a frequency response of 50 to 8,000 cycles per second at a speed of 7-1/2 inches per second, and a frequency response of 50 to 5,000 cycles per second at a speed of 3-3/4 inches per second.

This equipment uses a magnetic tape recording medium consisting of a magnetically coated paper and plastic base. The recording and reproducing heads are replaceable. Turn-over of the tape is required for the use of dual track operation. Recording time depends on the recording speed and the use of dual or single track operation.

Features of the set include such details as remote electrical stop-start, automatic shut-off, high speed shuttle and synchronous motor drive.

TECHNICAL CHARACTERISTICS:

Type: Electromagnet

Frequency Response:

Slow Speed: 50 to 5,000 cps

High Speed: 50 to 8,000 cps

Recording Medium: Magnetic tape*Tape Size:* 1/4 inch wide by 1,250 foot long (maximum)*Number of Tracks:* 1 or 2 (turnover required for dual track)*Recording Speed:*

Slow: 3.75 inch per second

High: 7.5 inch per second

Continuous Recording Time:

Dual Track:

Slow Speed: 120 minutes

High Speed: 60 minutes

Single Track:

Slow Speed: 70 minutes

High Speed: 30 minutes

Amplifier Output: 5 w*Power Requirements:* 108- to 122-v, 55- to 65-cycle 1-phase ac

MAJOR COMPONENTS

QTY	ITEM	STOCK NUMBERS	DIMENSIONS (Inches)	WEIGHT (Lbs)
1	Recorder-Reproducer Set, Sound AN/SNH-1			

REFERENCE DATA AND LITERATURE:

SHIPPING DATA

PKGS	VOLUME (Cu Ft)	WEIGHT (Lbs)

MIL-HDBK-161

AN/SNH-1 SOUND RECORDER-REPRODUCER SET

PROCUREMENT DATA

PROCURING SERVICE: USN
SPEC &/or DWG: MIL-R-918 (SHIPS)

DESIGN COG: USN, BuShips

CONTRACTOR	LOCATION	CONTRACT OR ORDER NO.	APPROX UNIT COST
Mark Simpson Manufacturing Co.	Long Island City, New York, N. Y.	NObs-50472	

SOUND RECORDER-REPRODUCER SET **AN/SNH-2**

1 December 1958

Cognizant Serv: USN FSN:

USA

USN

USAF

TYPE CLASS: --

Used by

--

STOCK NO: --

--

--

(No Illustration Available)

FUNCTIONAL DESCRIPTION:

Sound Recorder-Reproducer Set AN/SNH-2 is a portable, electromagnetic equipment designed for a frequency response of 100 to 7,000 cycles per second.

This equipment uses a recording medium of 0.0046-inch diameter silicon wire.

The recording and erasing heads are replaceable.

The set provides a maximum of 3 hours of recording time at a speed of 2 feet per second.

TECHNICAL CHARACTERISTICS:

Type: Electromagnetic

Frequency Response: 100 cps to 7,000 cps

Recording Medium: Silicon wire

Wire Size: 0.0046 in. dia

Recording Time: 3 hr maximum, continuous

Speed: 2 feet per second

Amplifier Output: 2 w

Power Requirements: 115-v 60-cycle 1-phase ac

MAJOR COMPONENTS

QTY	ITEM	STOCK NUMBERS	DIMENSIONS (Inches)	WEIGHT (Lbs)
1	Recorder-Reproducer Set, Sound AN/SNH-2			

REFERENCE DATA AND LITERATURE:

SHIPPING DATA

PKGS	VOLUME (Cu Ft)	WEIGHT (Lbs)

MIL-HDBK-161

AN/SNH-2 SOUND RECORDER-REPRODUCER SET

PROCUREMENT DATA

PROCURING SERVICE: USN
SPEC &/or DWG:

DESIGN COG: USN, BuShips

CONTRACTOR	LOCATION	CONTRACT OR ORDER NO.	APPROX UNIT COST
Brush Development Co.	Cleveland, Ohio	NObs-46104	

SOUND RECORDER-REPRODUCER SET **AN/SNH-3**

1 December 1958

Cognizant Serv: USN FSN:

USA

USN

USAF

TYPE CLASS: --

Used by --

STOCK NO: --

(No Illustration Available)

FUNCTIONAL DESCRIPTION:

Sound Recorder-Reproducer Set AN/SNH-3 is a portable, electromagnetic equipment designed for a frequency response of 100 to 7,000 cycles per second at +2 decibels to -6 decibels using a 1,000-cycle-per-second reference level.

The recording medium of this equipment is wire of a magnetic material plated on a copper silicon base.

The set permits 3 hours of continuous recording time at a speed of 2 feet per second.

TECHNICAL CHARACTERISTICS:*Type:* Electromagnetic*Frequency Response:* 100 cps to 7,000 cps, +2 db to -6 db, 1,000-cps reference*Recording Medium:* Wire*Wire Diameter:* 0.00475 inch by 7,400 foot long*Recording Time:* 3 hr continuous*Speed:* 2 feet per second*Amplifier Output:* 57.5 w*Power Requirements:* 105- to 120-v 60-cycle 1-phase ac**MAJOR COMPONENTS**

QTY	ITEM	STOCK NUMBERS	DIMENSIONS (Inches)	WEIGHT (Lbs)
1	Recorder-Reproducer Set, Sound AN/SNH-3			

REFERENCE DATA AND LITERATURE:**SHIPPING DATA**

PKGS	VOLUME (Cu Ft)	WEIGHT (Lbs)

MIL-HDBK-161

AN/SNH-3 SOUND RECORDER-REPRODUCER SET

PROCUREMENT DATA

PROCURING SERVICE: USN
SPEC &/or DWG:

DESIGN COG: USN, BuShip

CONTRACTOR	LOCATION	CONTRACT OR ORDER NO.	APPROX UNIT COST
Brush Development Co.	Cleveland, Ohio	NObs-47359	

SOUND RECORDER-REPRODUCER SET **AN/SNH-6**

1 December 1958

Cognizant Serv: USN FSN:

USA

USN

USAF

TYPE CLASS: --

Used by --

STOCK NO: --

(No Illustration Available)

FUNCTIONAL DESCRIPTION:

Sound Recorder-Reproducer Set AN/SNH-6 is an electromagnetic equipment that uses a cellulose acetate 35-millimeter film. It is designed to provide normal frequency response of 250 to 4,500 cycles per second at a speed of 40 feet per minute.

Special features of the equipment permit 2 hours of recording at a speed of 60 feet per minute; it incorporates a public address system and a monitor indicator.

TECHNICAL CHARACTERISTICS:

Type: Electromagnetic*Frequency Response:* 25 cps to 4,500 cps*Recording Medium:* Cellulose acetate film*Film Size:* Standard 35-mm film width, 7,200 feet long (120 tracks)*Recording Time:* 3 hour maximum, continuous*Speed:* 40 feet per minute*Amplifier Output:* 3 w*Power Requirements:* 115-v 60-cycle 1-phase ac

MAJOR COMPONENTS

QTY	ITEM	STOCK NUMBERS	DIMENSIONS (Inches)	WEIGHT (Lbs)
1	Recorder-Reproducer Set, Sound AN/SNH-6			

REFERENCE DATA AND LITERATURE:

SHIPPING DATA

PKGS	VOLUME (Cu Ft)	WEIGHT (Lbs)

MIL-HDBK-161

AN/SNH-6 SOUND RECORDER-REPRODUCER SET

PROCUREMENT DATA

PROCURING SERVICE: USN
SPEC &/or DWG:

DESIGN COG: USN, BuShips

CONTRACTOR	LOCATION	CONTRACT OR ORDER NO.	APPROX UNIT COST
Frederick Hart and Co.	Poughkeepsie, N. Y.		

SOUND RECORDER-REPRODUCER SET **AN/SNH-7**

1 December 1958

Cognizant Serv: USN FSN:

USA

USN

USAF

TYPE CLASS: --

Used by

--

STOCK NO: --

--

--

(No Illustration Available)

FUNCTIONAL DESCRIPTION:

Sound Recorder-Reproducer Set AN/SNH-7 is an electromagnetic equipment that uses a steel wire recording medium. It is designed to provide a frequency response of 300 to 3,700 cycles per second, a 60 minute maximum recording time, and a recording and reproducing speed of 4 feet per second.

This is a portable equipment.

TECHNICAL CHARACTERISTICS:

Type: Electromagnetic

Frequency Response: 300 cps to 3,700 cps

Recording Medium: Steel wire

Recording Time: 60 minutes maximum, continuous

Speed: 4 ft per sec (both recording and reproducing)

Power Requirements: 115 v 60-cycle 1-phase ac

MAJOR COMPONENTS

QTY	ITEM	STOCK NUMBERS	DIMENSIONS (Inches)	WEIGHT (Lbs)
1	Recorder-Reproducer Set, Sound AN/SNH-7			

REFERENCE DATA AND LITERATURE:

SHIPPING DATA

PKGS	VOLUME (Cu Ft)	WEIGHT (Lbs)

MIL-HDBK-161

AN/SNH-7 SOUND RECORDER-REPRODUCER SET

PROCUREMENT DATA

PROCURING SERVICE: USN
SPEC &/or DWG:

DESIGN COG: USN, BuShips

CONTRACTOR	LOCATION	CONTRACT OR ORDER NO.	APPROX UNIT COST
Brush Development Co.	Cleveland, Ohio		

ANTENNA GROUP **AN/SRA-3**

1 December 1958

Cognizant Serv: USN FSN: 5895-254-7185

	USA	USN	USAF
TYPE CLASS:	--	--	--
STOCK NO:	--	F16-A-54463-5300	--

(No Illustration Available)

FUNCTIONAL DESCRIPTION:

Antenna Group AN/SRA-3 is a whip type unit designed to be used with Radio Sets SCR-508, SCR-510, SCR-528, SCR-608, SCR-610, SCR-628, SCR-300 and any other radio equipment requiring a 50-ohm antenna in the frequency range of this antenna group.

The antenna coupler of this equipment matches the applicable radio set to the antenna.

The antenna group can be used with the standardized series of Army equipment such as Radio Sets AN/GRC-3 through AN/GRC-8, AN/GRC-9, AN/GRC-10, AN/GRC-16, AN/GRC-17, and AN/GRC-18.

TECHNICAL CHARACTERISTICS:

Frequency Range in Mc: 20 to 50

Power Requirements: None

MAJOR COMPONENTS

QTY	ITEM	STOCK NUMBERS	DIMENSIONS (Inches)	WEIGHT (Lbs)
1	Antenna AT-252/SR	-----	131 x 9-1/2	25
1	Antenna Coupler CU-226/SR	-----	1-3/4 x 2-3/8 x 4-3/8	.5

REFERENCE DATA AND LITERATURE:

NAVSHIPS 91292

SHIPPING DATA

PKGS	VOLUME (Cu Ft)	WEIGHT (Lbs)
2	2	45

MIL-HDBK-161

AN/SRA-3 ANTENNA GROUP

PROCUREMENT DATA

PROCURING SERVICE: USN
SPEC &/or DWG:

DESIGN COG: USN, BuShips

CONTRACTOR	LOCATION	CONTRACT OR ORDER NO.	APPROX UNIT COST
Engineering and Research Corp.	Riverdale, Md.	NObsr-43445, 29 June 1949 NObsr-52485, 27 June 1951	

ELECTRICAL FILTER ASSEMBLY AN/SRA-9

1 December 1958

Cognizant Serv: USN FSN:

	USA	USN	USAF
TYPE CLASS:	--	Used by	--
STOCK NO:	--	--	--

(No Illustration Available)

FUNCTIONAL DESCRIPTION:

Electrical Filter Assembly AN/SRA-9 is a unit consisting of nine filter subassemblies designed to provide seven frequency channels for radio receivers. Channels are obtained by combining the provided plug-in filter subassemblies. As many as six of the nine subassemblies may be used simultaneously.

Each filter subassembly is comprised of a low-pass and a high-pass filter. The common crossover frequency between the two filters marks the division between channels.

The application of a single antenna at the filter input and seven receivers directly coupled to the filter output, results in practically the same efficiency as if each receiver had its own antenna. An additional 21 receivers connected to the filter output, in a decoupled arrangement, would not materially affect the directly coupled receivers, and the performance of the 21 additional receivers would be superior

to that of three or four receivers connected to a given antenna through a conventional patch panel.

This equipment employs a test set for checking the calibration of the filter assemblies. The antenna and receivers are connected to the filter assembly by means of coaxial patch cords.

The unit is similar to Electrical Filter Assembly AN/SRA-9A except for improved components in the later model.

TECHNICAL CHARACTERISTICS:

Frequency Range: 14 kc to 32 mc

Number of Channels: 7

Cutoff Frequencies:

Number: 9

Designations; 50; 150; 300; 530; 1,600; 2,000; 3,500; 7,000; 14,000 kc

Characteristic Impedance of Each Filter: 180 ohms

Power Requirements: None

MAJOR COMPONENTS

QTY	ITEM	STOCK NUMBERS	DIMENSIONS (Inches)	WEIGHT (Lbs)
1	Filter Assembly, Electrical F-145/SRA-9 consisting of:			
1	Filter Panel J-482/SRA-9	-----	2-1/8 x 8-2/3 x 19	10.25
9	Filter subassemblies	-----	2 x 3 x 4	18
1	Filter Case CY-1129/SRA-9	-----	10-3/4 x 11 x 25-3/4	24
1	Filter Test Set TS-734/SRA-9	-----	2 x 3 x 6-1/4	1
3	Shorting plug	-----	1-1/4 dia x 1-7/8	

REFERENCE DATA AND LITERATURE:

NAVSHIPS 91777

MIL-HDBK-161

AN/SRA-9 ELECTRICAL FILTER ASSEMBLY

SHIPPING DATA

PKGS	VOLUME (Cu Ft)	WEIGHT (Lbs)
------	----------------	--------------

PROCUREMENT DATA

PROCURING SERVICE: USN
SPEC &/or DWG:

DESIGN COG: USN, BuShips

CONTRACTOR	LOCATION	CONTRACT OR ORDER NO.	APPROX UNIT COST
Brubaker Manufacturing Co., Inc.	Los Angeles, Calif.	N123S-86863, 13 June 1952	

ELECTRICAL FILTER ASSEMBLY AN/SRA-9A

1 December 1958

Cognizant Serv: USN FSN: 5915-313-8465

	USA	USN	USAF
TYPE CLASS:	--	Used by	--
STOCK NO:	--	--	--

(No Illustration Available)

FUNCTIONAL DESCRIPTION:

Electrical Filter Assembly AN/SRA-9A provides a maximum of seven radio frequency channels by means of filter subassemblies which plug into the main chassis. Connections from the main chassis to an antenna and up to 28 receivers are made by coaxial patch cords. Any or all of the seven channels may be used simultaneously and independently.

This equipment consists essentially of a chassis and panel assembly with an antenna input jack, 28 output jacks, and nine filter subassemblies. Any one of the filter subassemblies can be used at one time. A filter test set is supplied for calibration checking of the filter subassemblies.

The unit is generally similar to Electrical Filter Assembly AN/SRA-9 except that the AN/SRA-9A has improved components.

TECHNICAL CHARACTERISTICS:

Frequency Range: 14 kc to 32 mc*Number of Channels:* 7*Subassembly Crossover Frequencies:*

Number: 9

Designations: 50; 150; 300; 530; 1,600; 2,000; 3,500; 7,000; 14,000 kc

Input and Output Impedance: 180 ohms*Reflection Loss:* Approximately 1db when input impedance is 70 ohms*Subassembly Type:* Both low- and high-pass filter network*Attenuation:* Between 3 and 6 db*Antenna Input:* 1*Output Jacks:* 28*Mounting Data:* Standard 19 in. relay rack*Power Requirements:* None

MAJOR COMPONENTS

QTY	ITEM	STOCK NUMBERS	DIMENSIONS (Inches)	WEIGHT (Lbs)
1	Case, Filter CY-1129A/SRA-9	-----	9-1/2 x 25-1/4 x 12-3/4	24.6
	or			
	CY-1325/SRA-9A	-----	6-1/4 x 12-3/8 x 9-3/8	12.12
3	Dummy connector plug	-----	1-7/8 x 1-1/4 dia	
9	Filter Subassembly	-----	4 x 2 x 3	18
				(total)
1	Panel, Filter J-482/SRA-9	-----	8-2/3 x 19 x 2-1/8	10.25
1	Test Set, Filter TS-734A/SRA-9A	-----	2 x 6-1/4 x 3-1/2	1

REFERENCE DATA AND LITERATURE:

NAVSHIPS 91777

MIL-HDBK-161

AN/SRA-9A ELECTRICAL FILTER ASSEMBLY

SHIPPING DATA

PKGS	VOLUME (Cu Ft)	WEIGHT (Lbs)
2	5.13	102.35

PROCUREMENT DATA

PROCURING SERVICE: USN
SPEC &/or DWG:

DESIGN COG: USN, BuShips

CONTRACTOR	LOCATION	CONTRACT OR ORDER NO.	APPROX UNIT COST
Brubaker Manufacturing Co., Inc.	Los Angeles, Calif.	N123s-86863, 13 June 1952	

ANTENNA COUPLER GROUP AN/SRA-13

1 December 1958
 Cognizant Serv: USN FSN: 5985-347-9752

	USA	USN	USAF
TYPE CLASS:	--	Used by	--
STOCK NO:	--	--	--

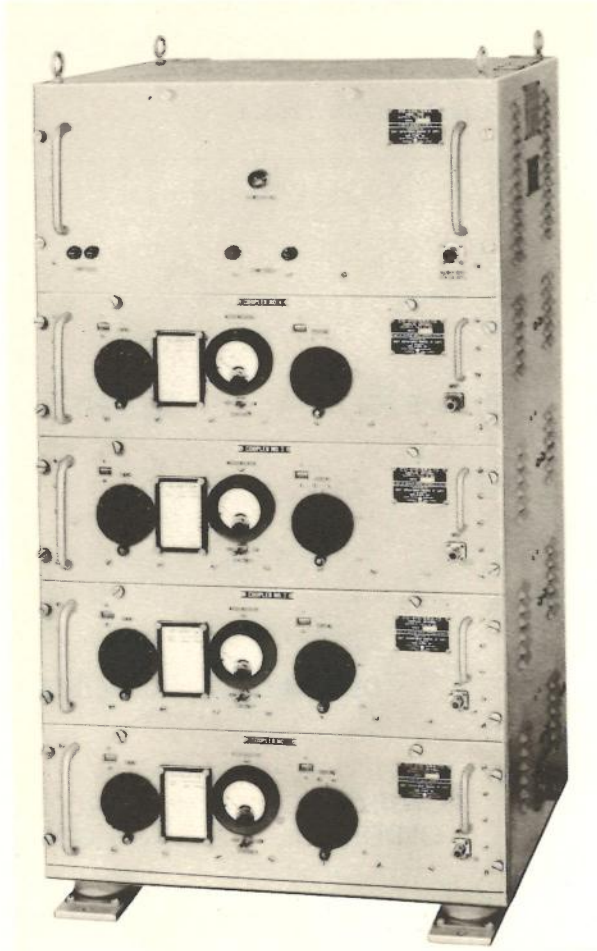

AN/SRA-13

FUNCTIONAL DESCRIPTION:

Antenna Coupler Group AN/SRA-13 is designed for ship-board operation for the purpose of coupling the output of four radio transmitters to a single broadband antenna.

This equipment may be used separately or in combination with other items of the series such as Antenna Coupler Groups AN/SRA-14 and AN/SRA-15 as well as AN/SRA-1b. In combination, these units provide an antenna-multicoupler system capable of simultaneously operating 12 transmitters, each with a power output of 500 watts. Generally, these antenna coupler groups are used with approved high frequency transmitters such as Radio Transmitting Equipment TBM.

Antenna Coupler Group AN/SRA-13 replaces Antenna Multi-Coupler CU-301/UR. The AN/SRA-13, AN/SRA-14, and AN/SRA-15 are similar except that they operate in different frequency ranges.

TECHNICAL CHARACTERISTICS:

- Frequency Range in Mc:* 2 to 6
- Tuning Band:* 1 band, continuously variable
- Type of Frequency Control:* Manual
- Input Impedance:* 50 ohms
- Output Impedance:* 50 ohms
- Efficiency:* Not less than 70%
- Voltage Isolation Ratio Between Adjacent Bands:* 15 to 1
- Power Handling Capability:* Simultaneous coupling of 4 (500 w, 100% AM hf) transmitters
- Antenna Data:* Broadband
- Power Requirements:* 115-v 60-cycle 1-phase ac

MIL-HDBK-161

AN/SRA-13 ANTENNA COUPLER GROUP

MAJOR COMPONENTS

QTY	ITEM	STOCK NUMBERS	DIMENSIONS (Inches)	WEIGHT (Lbs)
1	Cabinet, Electrical Equipment CY-1670/SRA	-----	20-1/2 x 26-1/4 x 46-3/4	122.5
4	Coupler, Antenna CU-419/ SRA-13	-----	7-23/32 x 18-3/16 x 24-3/4	43
2	Instruction Book NAVSHIPS 92746			
1	Panel, Fuse SB-406/SRA	-----	10-3/8 x 11-7/32 x 24-3/4	11.5

REFERENCE DATA AND LITERATURE:

NAVSHIPS 92746

SHIPPING DATA

PKGS	VOLUME (Cu Ft)	WEIGHT (Lbs)
1	18.8	416

PROCUREMENT DATA

PROCURING SERVICE: USN
SPEC &/or DWG:

DESIGN COG: USN, BuShips

CONTRACTOR	LOCATION	CONTRACT OR ORDER NO.	APPROX UNIT COST
National Electric Machine Shops-Clarke, Inc.	Silver Springs, Md.	NObsr-64322, 6 January 1953	\$3,500.00

ANTENNA COUPLER GROUP AN/SRA-14

1 December 1958

Cognizant Serv: USN FSN: 5985-347-9754

USA

USN

USAF

TYPE CLASS: --

Used by --

STOCK NO: --

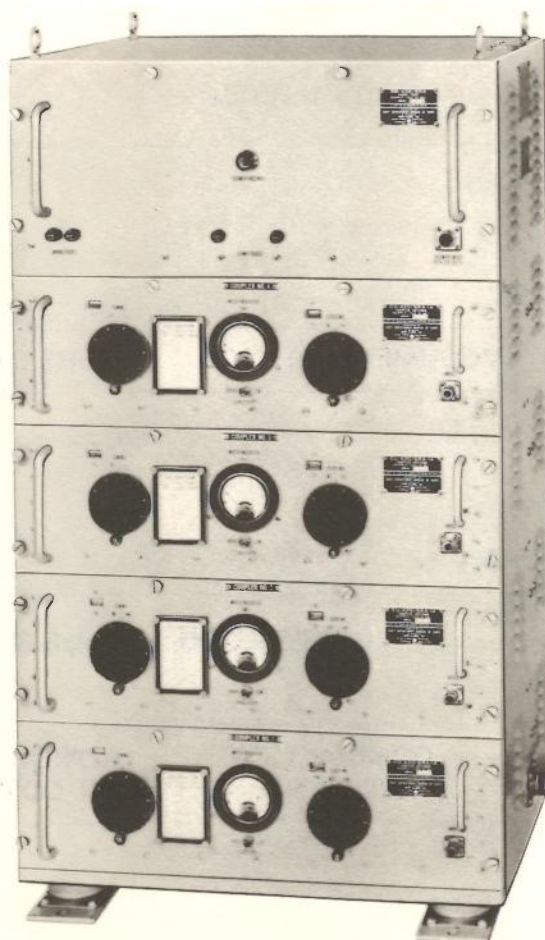

AN/SRA-14

FUNCTIONAL DESCRIPTION:

Antenna Coupler Group AN/SRA-14 is designed for ship-board operation for the purpose of coupling the output of four radio transmitters to a single broadband antenna.

This equipment may be used separately or in combination with other items of the series such as Antenna Coupler Groups AN/SRA-13, AN/SRA-14, and AN/SRA-1b. In combination, these units provide an antenna-multicoupler system capable of simultaneously operating 12 transmitters, each with a power output of 500 watts. Generally, these antenna coupler groups are used with approved high frequency transmitters such as Radio Transmitting Equipment TBM.

Antenna Coupler Group AN/SRA-14 replaces Antenna Multi-Coupler CU-302/UR. The AN/SRA-13, AN/SRA-14, and AN/SRA-15 are similar except that they operate in different frequency ranges.

TECHNICAL CHARACTERISTICS:

Frequency Range in Mc: 4 to 12

Tuning Band: 1 band, continuously variable

Type of Frequency Control: Manual

Input Impedance: 50 ohms

Output Impedance: 50 ohms

Efficiency: Not less than 68%

Voltage Isolation Ratio Between Adjacent Bands: 15 to 1:

Power Handling Capability: Simultaneous coupling of 4 (500 w, 100% AM hf) transmitters

Antenna Data: Broadband

Power Requirements: 115-v 60-cycle 1-phase ac

MIL-HDBK-161

AN/SRA-14 ANTENNA COUPLER GROUP

MAJOR COMPONENTS

QTY	ITEM	STOCK NUMBERS	DIMENSIONS (Inches)	WEIGHT (Lbs)
1	Cabinet, Electrical Equipment CY-1670/SRA	-----	20-1/2 x 26-1/4 x 46-3/4	122.5
4	Coupler, Antenna CU-420/ SRA-14	-----	7-23/32 x 18-3/16 x 24-3/4	36.5
2	Instruction Book NAVSHIPS 92746			
1	Panel, Fuse SB-406/SRA	-----	10-3/8 x 11-7/32 x 24-3/4	11.5

REFERENCE DATA AND LITERATURE:

NAVSHIPS 92746

SHIPPING DATA

PKGS	VOLUME (Cu Ft)	WEIGHT (Lbs)
1	18.8	390

PROCUREMENT DATA

PROCURING SERVICE: USN
SPEC &/or DWG:

DESIGN COG: USN, BuShips

CONTRACTOR	LOCATION	CONTRACT OR ORDER NO.	APPROX UNIT COST
National Electrical Machine Shops-Clarke, Inc.	Silver Springs, Md.		

ANTENNA COUPLER GROUP AN/SRA-15

Cognizant Serv: USN FSN: 5985-347-9756

USA

USN

USAF

TYPE CLASS: --
STOCK NO: --

Used by --

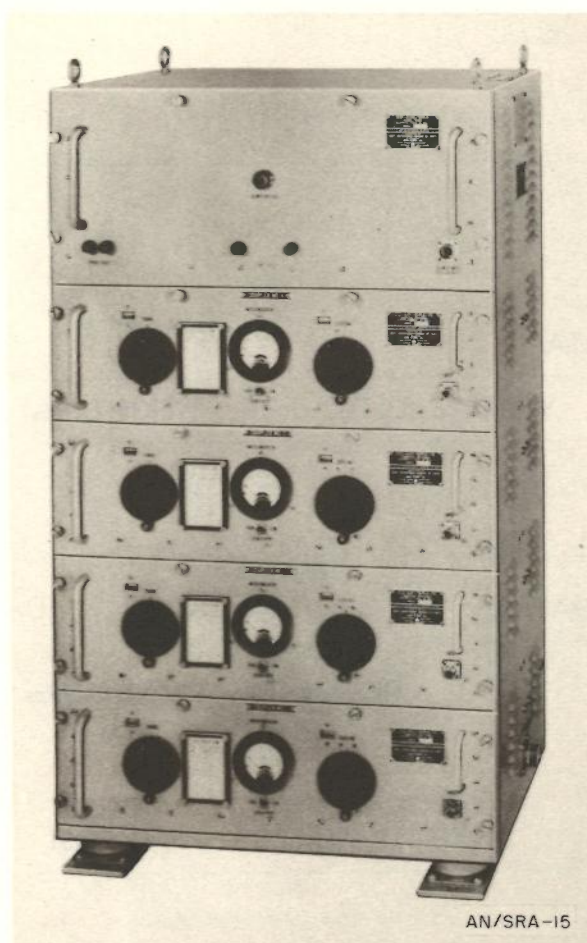

AN/SRA-15

FUNCTIONAL DESCRIPTION:

Antenna Coupler Group AN/SRA-15 is designed for shipboard operation for the purpose of coupling the output of four radio transmitters to a single broadband antenna.

This equipment may be used separately or in combination with other items of the series such as Antenna Coupler Groups AN/SRA-13, AN/SRA-14, and AN/SRA-1b. In combination, these units provide an antenna-multicoupler system capable of simultaneously operating 12 transmitters, each with a power output of 500 watts. Generally, these antenna coupler groups are used with approved high frequency transmitters such as Radio Transmitting Equipment TBM.

Antenna Coupler Group AN/SRA-15 replaces Antenna Multi-Coupler CU-303/UR. The AN/SRA-13, AN/SRA-14, and AN/SRA-15 are similar except that they operate in different frequency ranges.

TECHNICAL CHARACTERISTICS:

Frequency Range in Mc: 6 to 18

Tuning Band: 1 band, continuously variable

Type of Frequency Control: Manual

Input Impedance: 50 ohms

Output Impedance: 50 ohms

Efficiency: Not less than 60%

Voltage Isolation Ratio Between Adjacent Bands: 15 to 1

Power Handling Capability: Simultaneous coupling of 4 (500 w, 100% AM hf) transmitters

Antenna Data: Broadband

Power Requirements: 115-v 60-cycle 1-phase ac

MIL-HDBK-161

AN/SRA-15 ANTENNA COUPLER GROUP

MAJOR COMPONENTS

QTY	ITEM	STOCK NUMBERS	DIMENSIONS (Inches)	WEIGHT (Lbs)
1	Cabinet, Electrical Equipment CY-1670/SRA	-----	20-1/2 x 26-1/4 x 46-3/4	122.5
4	Coupler, Antenna CU-421/ SRA-15	-----	7-23/32 x 18-3/16 x 24-3/4	35.5
2	Instruction Book NAVSHIPS 92746			
1	Panel, Fuse SB-406/SRA	-----	10-3/8 x 11-7/32 x 24-3/4	11.5

REFERENCE DATA AND LITERATURE:

NAVSHIPS 92746

SHIPPING DATA

PKGS	VOLUME (Cu Ft)	WEIGHT (Lbs)
1	18.8	386

PROCUREMENT DATA

PROCURING SERVICE: USN
SPEC &/or DWG:

DESIGN COG: USN, BuShips

CONTRACTOR	LOCATION	CONTRACT OR ORDER NO.	APPROX UNIT COST
National Electrical Machine Shops-Clarke, Inc.	Silver Springs, Md.		

ANTENNA COUPLER GROUP AN/SRA-16

Cognizant Serv: USN FSN: 5985-347-9758

USA

USN

USAF

TYPE CLASS: --
STOCK NO: --

Used by --

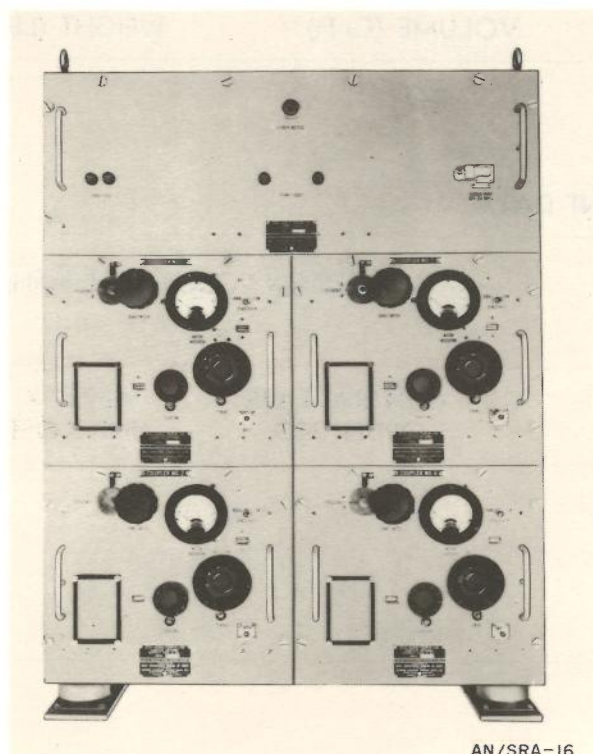

AN/SRA-16

FUNCTIONAL DESCRIPTION:

Antenna Coupler Group AN/SRA-16 is designed to couple into one broadband antenna four transmitters operating simultaneously at frequencies approximately 10 percent from each other.

The antenna couplers of this equipment are of the plug-in-type; however, they are not interchangeable since the output plugs are at different locations on each rotron blower motor.

TECHNICAL CHARACTERISTICS:

Frequency Range: 9 mc to 26 mc

Input Impedance: 50 ohms

Output Impedance: 50 ohms

Power Requirements: 115-v 60-cycle 1-phase ac

MAJOR COMPONENTS

QTY	ITEM	STOCK NUMBERS	DIMENSIONS (Inches)	WEIGHT (Lbs)
1	Antenna Coupler CU-422/ SRA-16	-----	12-3/8 x 13-3/4 x 24-3/4	
1	Antenna Coupler CU-423/ SRA-16	-----	12-3/8 x 13-3/4 x 24-3/4	
1	Antenna Coupler CU-424/ SRA-16	-----	12-3/8 x 13-3/4 x 24-3/4	
1	Antenna Coupler CU-425/ SRA-16	-----	12-3/8 x 13-3/4 x 24-3/4	
1	Cabinet, Electrical Equipment CY-1671/SRA-16	-----	25-1/8 x 29-1/4 x 39-3/4	
1	Panel, Fuse SB-407/SRA-16	-----	9-7/8 x 10-7/8 x 27-3/4	

MIL-HDBK-161

AN/SRA-16 ANTENNA COUPLER GROUP

REFERENCE DATA AND LITERATURE:

SHIPPING DATA

PKGS	VOLUME (Cu Ft)	WEIGHT (Lbs)
------	----------------	--------------

PROCUREMENT DATA

PROCURING SERVICE: USN
SPEC &/or DWG:

DESIGN COG: USN, BuShips

CONTRACTOR	LOCATION	CONTRACT OR ORDER NO.	APPROX UNIT COST
------------	----------	--------------------------	---------------------

National Electrical Machine Shops, Clarke,
Inc.

Silver Springs, Md.

NObsr-63422, 4 August 1954

MODULATOR UNIT AN/SRA-type

7 November 1958

Cognizant Serv: USN FSN:

50065-A

USA

USN

USAF

TYPE CLASS: --

Used by --

STOCK NO: --

(No Illustration Available)

FUNCTIONAL DESCRIPTION:

Modulator Unit 50065-A is designed for use on all types of vessels except some submarines. It contains the apparatus necessary for taking power from a suitable power source, rectifier, or motor generator and modulating the transmitter with which it is used by either tone or voice.

The 50065-A is a part of Radio Transmitting Equipment TBM and can be used with Radio Transmitters 52170, 52171, 52217, and 52218.

TECHNICAL CHARACTERISTICS:

Speech Input: At a 6-mw level from a 600-ohm source, capable

of effecting 100% plate modulation of the transmitter with an AF distortion of less than 10%

Audio Frequency Range: 100 to 5,000 cps from final amplifier

Modulation Gain: 60 db

Modulation Frequency: For mcw, 700 cps obtained from audio oscillator in modulator unit

Power Output: 400 w

Power Requirements:

115-v dc $\pm 10\%$

230-v dc $\pm 10\%$

220-v 60-cycle 1-phase ac

220-v 60-cycle 3-phase ac

440-v 60-cycle 3-phase ac

MAJOR COMPONENTS

QTY	ITEM	STOCK NUMBERS	DIMENSIONS (Inches)	WEIGHT (Lbs)
1 set	Equipment spares			
1	Modulator Unit 50065-A	-----	18 x 24 x 72	385
(Equipment consists of only one major component.)				

REFERENCE DATA AND LITERATURE:

Technical manual for Modulator Unit 50065-A

SHIPPING DATA

PKGS	VOLUME (Cu Ft)	WEIGHT (Lbs)
2	36.32	623

MIL-HDBK-161

AN/SRA-type MODULATOR UNIT

PROCUREMENT DATA

PROCURING SERVICE: USN
SPEC &/or DWG:

DESIGN COG: USN, BuShips

CONTRACTOR	LOCATION	CONTRACT OR ORDER NO.	APPROX UNIT COST
Westinghouse Electric Corp.	Baltimore, Md.	NXsr-51573, 14 March 1944	\$1,500 with equipment spares

ANTENNA ASSEMBLY AN/SRA-type

5 December 1958

Cognizant Serv: USN FSN: 5985-030-0095

AS-390/SRC

USA

USN

USAF

TYPE CLASS: --

Used by

--

STOCK NO: --

F16-A-53590-1001

--

(No Illustration Available)

FUNCTIONAL DESCRIPTION:

Antenna Assembly AS-390/SRC is a broadband, coaxial stub antenna, used for transmitting or receiving vertically polarized waves at frequencies from 220 to 440 mc

The antenna is unbalanced to ground and its characteristics are similar to Antenna AT-150/SRC.

TECHNICAL CHARACTERISTICS:

Frequency Range: 220 to 440 mc*Nominal Input Impedance:* 52 ohms*Standing Wave Ratio:* 1.9:1*Ambient Temperature Limit:* 177°C. (350°F.)*Installation:* Mounted on top of a mast or pig stick with main axis vertical

MAJOR COMPONENTS

QTY	ITEM	STOCK NUMBERS	DIMENSIONS (Inches)	WEIGHT (Lbs)
1	Antenna Assembly AS-390/ SRC	-----	16 x 23 x 23	3.625
1	Maintenance Kit	-----	4 x 4 x 3	2
1	Wrench	-----	5 x 5 x 11/16	.3

REFERENCE DATA AND LITERATURE:

NAVSHIPS 91338

SHIPPING DATA

PKGS	VOLUME (Cu Ft)	WEIGHT (Lbs)
1	2.25	8.5

MIL-HDBK-161

AN/SRA-type ANTENNA ASSEMBLY

PROCUREMENT DATA

PROCURING SERVICE: USN
SPEC &/or DWG:

DESIGN COG: USN, BuShips

CONTRACTOR	LOCATION	CONTRACT OR ORDER NO.	APPROX UNIT COST
Bird Electronic Corp.	Cleveland, Ohio	NObsr-43272, 21 April 1949	\$48.00

ANTENNA **AN/SRA-type**

5 December 1958

Cognizant Serv: USN FSN:

AT-150/SRC

USA

USN

USAF

TYPE CLASS: --
STOCK NO: --Used by
F16-A-51900-1201

(No Illustration Available)

FUNCTIONAL DESCRIPTION:

Antenna AT-150/SRC is a broad band, coaxial dipole antenna, used for transmitting or receiving vertically polarized waves at frequencies from 220 to 440 mc.

The antenna is balanced to ground and its radiation pattern is similar to that of a conventional dipole.

TECHNICAL CHARACTERISTICS:

Frequency Range: 220 to 440 mc*Input Impedance:* 52 ohms*Standing Wave Ratio:* 2.1:1*Ambient Temperature Limit:* 177°C. (350°F.)*Installation:* Mounted at the end of a yardarm or bracket with the radiating element in a vertical position

MAJOR COMPONENTS

QTY	ITEM	STOCK NUMBERS	DIMENSIONS (Inches)	WEIGHT (Lbs)
1	Antenna AT-150/SRC	-----	17-3/8 x 22-7/16 x 3-1/4	4.5
1	Maintenance kit (includes box)	-----	4 x 4 x 3	2.25

REFERENCE DATA AND LITERATURE:

NAVSHIPS 91338

SHIPPING DATA

PKGS	VOLUME (Cu Ft)	WEIGHT (Lbs)
1	1.33	10.5

MIL-HDBK-161

AN/SRA-type ANTENNA

PROCUREMENT DATA

PROCURING SERVICE: USN
SPEC &/or DWG:

DESIGN COG: USN, BuShips

CONTRACTOR	LOCATION	CONTRACT OR ORDER NO.	APPROX UNIT COST
Bird Electronic Corp.	Cleveland, Ohio	NObsr-43272, 23 April 1949	\$70.00

RADIO SET CONTROL **AN/SRA-type**

5 December 1958

Cognizant Serv: USN FSN:

C-682/SR

	USA	USN	USAF
TYPE CLASS:	--	Used by	--
STOCK NO:	--	--	--

(No Illustration Available)

FUNCTIONAL DESCRIPTION:

Radio Set Control C-682/SR is a panel designed for centralized control of Radio Sets AN/ARC-1, MAR, RDR, and TCS, and loudspeakers and handsets. The audio output circuits of four Radio Sets, AN/ARC-1, MAR, RDR, and TCS, are permanently connected to the radio set control. Selector switches are provided on the front panel so that the output of any one of the four radio sets may be connected to either one or both of the two loudspeakers.

Individual volume controls are provided for each loud-

speaker. To provide for two-way communication, where applicable, the audio circuits of the four radio sets may be connected to handsets. The handsets are not permanently connected to the panel but may be plugged into any one of the five connectors mounted on the housing of the panel. Four of these connectors are permanently connected to each of the four radio sets, and the fifth connector is common to any one of the four radio sets by means of a switch.

TECHNICAL CHARACTERISTICS:

(None.)

MAJOR COMPONENTS

QTY	ITEM	STOCK NUMBERS	DIMENSIONS (Inches)	WEIGHT (Lbs)
1	Radio Set Control C-682/SR (This equipment consists of only one major component.)	-----	5-7/8 x 13-5/8 x 17	40

REFERENCE DATA AND LITERATURE:

NAVSHIPS 91307

SHIPPING DATA

PKGS	VOLUME (Cu Ft)	WEIGHT (Lbs)

MIL-HDBK-161

AN/SRA-type RADIO SET CONTROL

PROCUREMENT DATA

PROCURING SERVICE: USN
SPEC &/or DWG:

DESIGN COG: USN, BuShips

CONTRACTOR	LOCATION	CONTRACT OR ORDER NO.	APPROX UNIT COST
Bendix Aviation Corp., Friez Instrument Division	Baltimore, Md.	NObs-47842	

ANTENNA CONTROL AN/SRA-type

5 December 1958

Cognizant Serv: USN FSN: 5985-665-1905

C-1670/U

USA

USN

USAF

TYPE CLASS: --
STOCK NO: --

Used by --

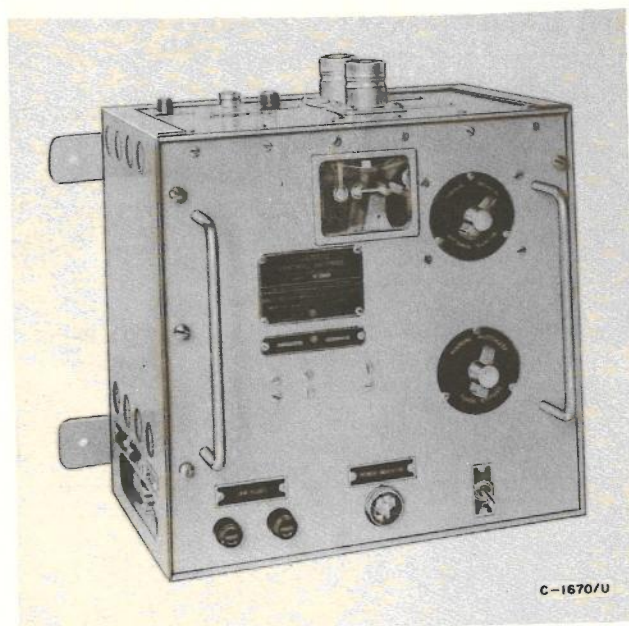

FUNCTIONAL DESCRIPTION:

Antenna Control C-1670/U provides facilities for controlling transmitter keying and antenna switching from the receive to transmit position. This equipment provides an automatic antenna transfer system for break-in operation. The unit is interconnected with the keying circuit of the associated transmitter so that the antenna transfer contacts are never required to break the antenna current.

Provision is made for bulkhead mounting of the unit. It is used with Radio Transmitting Sets AN/SRT-14, AN/SRT-15, AN/SRT-16 and Radio Transmitting Equipments of the TBL-series.

TECHNICAL CHARACTERISTICS:

Frequency Range in Mc: 2 to 20

Keying Speed: 60 words per minute

Circuit Closing Delay: Adjustable; 0 to 1 second

Power Requirements: 115-v, 60-cycle 1-phase ac

MAJOR COMPONENTS

QTY	ITEM	STOCK NUMBERS	DIMENSIONS (Inches)	WEIGHT (Lbs)
1	Antenna Control C-1670/U	-----	9-1/2 x 13 1/2 x 15-1/4	39
1	Spare parts box	-----	6 x 9 x 12	12
1 set	Accessories	-----	2 x 4-1/2 x 4-3/4	3-5/16

REFERENCE DATA AND LITERATURE:

NAVSHIPS 92566

MIL-HDBK-161

AN/SRA-type ANTENNA CONTROL

SHIPPING DATA

PKGS	VOLUME (Cu Ft)	WEIGHT (Lbs)
------	----------------	--------------

PROCUREMENT DATA

PROCURING SERVICE: USN
SPEC &/or DWG: MIL-A-16318A

DESIGN COG: USN, BuShips

CONTRACTOR	LOCATION	CONTRACT OR ORDER NO.	APPROX UNIT COST
Mercury Manufacturing Corp.	Buffalo, N. Y.	NObsr-57139	\$1,500.00 with spares

ANTENNA COUPLER **AN/SRA-type**

5 December 1958

Cognizant Serv: USN FSN:

CU-284/UR

USA

USN

USAF

TYPE CLASS: --

Used by --

STOCK NO: --

F16-C-91723-5001 --

(No Illustration Available)

FUNCTIONAL DESCRIPTION:

Antenna Coupler CU-284/UR is an ultra-high frequency power coupling and impedance-matching device used aboard ship to make possible the simultaneous operation of two radio transmitters and/or receivers from a single antenna. The purpose of this equipment is to improve the over-all efficiency of ultra-high frequency radio communications by installing the smaller number of ultra-high frequency antennas in the few satisfactory locations aboard ship.

The unit consists essentially of two parallel connected, capacity-tuned, resonant cavities forming two identical channels which may be used for transmitting or receiving. Separate manually operated tuning controls permit independent tuning of each cavity. Each channel is capable of transferring 100 watts of radio frequency power.

Antenna Coupler CU-284/UR is intended for use primarily with Radio Receiving Sets AN/URR-13 and AN/URR-35,

and with Radio Transmitting Equipment TED. It can be used with other ultra-high frequency transmitting and receiving equipment where automatic quick-shift operation is not required. It is used with ultra-high frequency Antennas AT-150/SRT, AS-390/SRC, AS-486/B, AS-505/GR, and the ultra-high frequency section of Antenna Assembly AS-493/U.

The following equipment is required, but is not supplied, with Antenna Coupler CU-284/UR: Cable RG-8/U, RG-9/U or RG-10/U.

TECHNICAL CHARACTERISTICS:*Frequency Range in Mc:* 225 to 400*Output Impedance:* 50 ohms*Mounting Data:* Shelf or bulkhead mounting, with adequate grounding of the chassis*Power Requirements:* None**MAJOR COMPONENTS**

QTY	ITEM	STOCK NUMBERS	DIMENSIONS (Inches)	WEIGHT (Lbs)
1	Antenna Coupler CU-284/UR	-----	8-5/16 x 13 x 6-3/8	16
3	Cable Connector UG-941A/U or equivalent			

REFERENCE DATA AND LITERATURE:

NAVSHIPS 91790

SHIPPING DATA

PKGS	VOLUME (Cu Ft)	WEIGHT (Lbs)
1	1.1	31

MIL-HDBK-161

AN/SRA-type ANTENNA COUPLER

PROCUREMENT DATA

PROCURING SERVICE: USN
SPEC &/or DWG:

DESIGN COG: USN, BuShips

CONTRACTOR	LOCATION	CONTRACT OR ORDER NO.	APPROX UNIT COST
Harvey-Wells Electronics, Inc.	Southbridge, Mass.	NObsr-52597	

ANTENNA COUPLER **AN/SRA-type**

5 December 1958

Cognizant Serv: USN FSN:

CU-377/UR

USA

USN

USAF

TYPE CLASS:
STOCK NO:--
--Used by

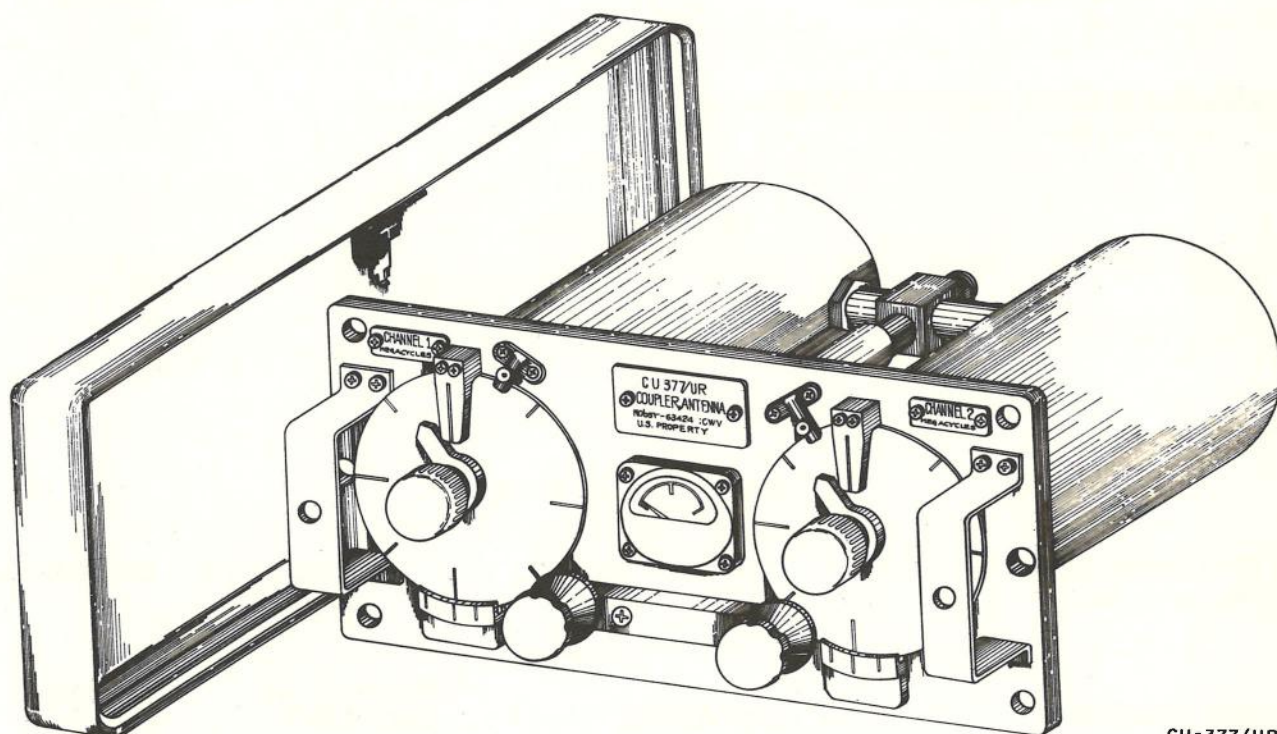
--

CU-377/UR

FUNCTIONAL DESCRIPTION:

Antenna Coupler CU-377/UR is intended for use aboard naval vessels with radio communication equipment consisting of several transmitters and/or receivers. The coupler permits the simultaneous operation of two ultra-high frequency transmitters or receivers into a single antenna in the frequency range of 225 to 400 megacycles. It is primarily intended for use with Radio Transmitting Equipment TED and Radio Receiving Equipment AN/URR-13.

The CU-377/UR is similar to Antenna Coupler CU-

284/UR except for better resettability, lower insertion loss, and greater adjacent channel separations.

Interconnecting cables as required are used with, but are not supplied with, Antenna Coupler CU-377/UR.

TECHNICAL CHARACTERISTICS:

Frequency Range in Mc: 225 to 400

Output Impedances:

Antenna: 50 ohms

Channel 1: 50 ohms

Channel 2: 50 ohms

Type of Tuning: Manual tuning of capacity tuned cavities

Power Requirements: None

MIL-HDBK-161

AN/SRA-type ANTENNA COUPLER

MAJOR COMPONENTS

QTY	ITEM	STOCK NUMBERS	DIMENSIONS (Inches)	WEIGHT (Lbs)
1	Antenna Coupler CU-377/UR	-----	5-1/4 x 7-5/32 x 11	9.5
3	Mating Connector UG-21B/U			

REFERENCE DATA AND LITERATURE:

NAVSHIPS 92187

SHIPPING DATA

PKGS	VOLUME (Cu Ft)	WEIGHT (Lbs)
1	1.1	24.5

PROCUREMENT DATA

PROCURING SERVICE: USN
SPEC &/or DWG: SHIPS-C-1120

DESIGN COG: USN, BuShips

CONTRACTOR	LOCATION	CONTRACT OR ORDER NO.	APPROX UNIT COST
Harvey-Wells Electronics, Inc.	Southbridge, Mass.	NObsr-63424, 4 May 1953	\$1,100.00 with spares.

3 December 1958

KEYER AN/SRA-type

Cognizant Service: USNFSN: 5820-318-4449

KY-83()/S

USA

USN

USAF

TYPE CLASS:

Used by

STOCK NO:

KY-83/S: F-16-K-
476871151**FUNCTIONAL DESCRIPTION:**

Keyer KY-83()/S adapts communication radio transmitters and receivers to remote-control operation of magnetic minesweeping equipment. This keyer makes it possible to transmit and receive the timing pulses used in minesweeping, by utilizing available radio communication equipment without interrupting the normal function of such units.

The KY-83/S and KY-83A/S are functionally identical; their dimensions differ slightly according to the manufacturer. They are operated with Auxiliary Controllers Mark VI and VII and combinations of radio receivers and transmitters for detonating magnetic mines.

TECHNICAL CHARACTERISTICS:**TRANSMITTING SECTION:**

Input Impedance: 600, 300, or 50 ohms
Output Impedance: 600, 300, or 50 ohms
Type of Signal: 500 cps, stability ± 10 cps (under $\pm 10\%$ variation in 115 v dc)
Output Level: 0 to 2 v (adjustable)

RECEIVING SECTION:

Input Impedance: 600, 300, or 50 ohms
Output Impedance: 600, 300, or 50 ohms for speech channel;
 600 or 40 for tone channel
Audio Output: 300 mw
Tone Output: 0 to 0.1 v rms (adjustable) into impedance of
 4 ohms ± 40 ohms
Power Requirements: 65 w, 115-v ($\pm 10\%$) dc

TRANSMISSION LINE TUNER **AN/SRA-type**

20 October 1958

Cognizant Serv: USN FSN: 5820-284-5980
5985-284-5980

TN-233/SRC

	USA	USN	USAF
TYPE CLASS:	--	Used by	--
STOCK NO:	--	--	--

(No Illustration Available)

FUNCTIONAL DESCRIPTION:

Transmission Line Tuner TN-233/SRC is a substitute for and performs the functions of Loading Coil 47205 for Radio Transmitting and Receiving Equipment TCS. In addition, it embodies the following features: an internal dummy load and provisions for an external dummy load for testing the output of the transmitter, a built-in pick-up loop with a connector for a frequency meter, and a means for grounding the antenna when the radio equipment is not in use. Also, 3-inch coaxial lines may be used, thus reducing the radio-frequency field in the operating circuits and improving the over-all efficiency of the TCS equipment.

The tuner provides the necessary inductance and capacitance to artificially increase or decrease the antenna length. This permits the transmitter to be coupled more efficiently, particularly in the frequency range of 1,500 to 3,000 kc. Switches provide the necessary connections for testing the

transmitter output and for grounding the antenna, for selection of the amount of inductance used, and for inserting capacitance in series with the antenna. A 12.5-ohm dummy load may be connected through either a 100- or 300- μ f capacitor to provide proper loading.

The TN-233/SRC has been designed primarily for use with the TCS. However, it may be used with any low-, medium-, or high-frequency radio transmitter having a radio-frequency output up to and including 125 watts.

TECHNICAL CHARACTERISTICS:*Frequency Range:* 1,500 to 12,000 kc*Input Impedance:* 50 ohms (nominal) for direct connection to the TCS*Output Impedance:* Varies to match antenna in use*Internal Dummy Load Rating:* 20 w (maximum)*External Dummy Load Rating:* 125 w (maximum)**MAJOR COMPONENTS**

QTY	ITEM	STOCK NUMBERS	DIMENSIONS (Inches)	WEIGHT (Lbs)
1	Transmission Line Tuner TN-233/SRC (Equipment consists of only one major component.)	-----	8 x 8-1/4 x 9	11

REFERENCE DATA AND LITERATURE:NAVSHIPS 92794
92343**SHIPPING DATA**

PKGS	VOLUME (Cu Ft)	WEIGHT (Lbs)
1	0.81	13-1/2

MIL-HDBK-161

AN/SRA-type TRANSMISSION LINE TUNER

PROCUREMENT DATA

PROCURING SERVICE: USN

DESIGN COG: USN, BuShips

SPEC &/or DWG: Spec MIL-E-17362A (Ships)

Clearfield Broadcasters, Inc., Manufacturing Clearfield, Pa.
Division

NObsr-71146

\$90.00

RADIO SET AN/SRC-6()

1 July 1958

Cognizant Serv: USA FSN:

USA

USN

USAF

TYPE CLASS: Std
 STOCK NO: 2S4003-6



FUNCTIONAL DESCRIPTION:

Radio Set AN/SRC-6 (Radiomarine Model ET-8053) (shown above) and Radio Set AN/SRC-6A (Mackay Type 401-A) are portable radiotelegraph transmitters and receivers, powered by a built-in hand-driven generator, for emergency use in lifeboats or other survival craft.

This equipment consists of a transmitter and receiver with a built-in hand generator and an antenna system.

Automatic or manual keying is provided to transmit twelve 4-second dashes with 1-second pauses followed by three distress signals on 500 kc, and three distress signals followed by a 30-second dash for direction finding on 8,364 kc.

Two-way communication can be accomplished by manual keying only.

The AN/SRC-6 and AN/SRC-6A are generally interchangeable as to purpose and use.

TECHNICAL CHARACTERISTICS:

Frequency Range in Mc:

Transmitter: 0.5 to 8.364

Receiver: 0.5 (fixed); 8.25 to 8.75 (AN/SRC-6); 8.266 to 8.745 (AN/SRC-6A)

Type Modulation: AM

Type of Signal: Modulated keyed telegraphy (revr, xmtr); cw (revr)

Power Output:

AN/SRC-6: 2 w on 0.5 mc, 5 w on 8.64 mc

AN/SRC-6A: 1.7 w (min) on 0.5 mc; 4 w (min) on 8.364 mc

Power Requirements: Built-in hand generator

MAJOR COMPONENTS

QTY	ITEM	STOCK NUMBERS	DIMENSIONS (Inches)	WEIGHT (Lbs)
1	Watertight case containing transmitter, receiver, and hand generator	-----	20-1/2 x 12-1/2 x 14-7/16	58.5

REFERENCE DATA AND LITERATURE:

Commercial Instruction Book NAVSHIPS 92207

MIL-HDBK-161

AN/SRC-6() RADIO SET

SHIPPING DATA

PKGS	VOLUME (Cu Ft)	WEIGHT (Lbs)
------	----------------	--------------

PROCUREMENT DATA

PROCURING SERVICE: USA
SPEC &/or DWG:

DESIGN COG: USA, Sig C

CONTRACTOR	LOCATION	CONTRACT OR ORDER NO.	APPROX UNIT COST
Mackay Radio & Telegraph Co., Inc., Marine Division	Clark, N. J.	25692-P-53-36	\$1,150.12
RCA-RCA Victor Division	New York, N. Y.	33759-P-53-36	966.21

RADIO SET **AN/SRC-7**

1 July 1958

Cognizant Serv: USA FSN:

USA

USN

USAF

TYPE CLASS:

Std

--

--

STOCK NO:

2S4003-7

--

--

**FUNCTIONAL DESCRIPTION:**

Radio Set AN/SRC-7 (Radiomarine Model 5U) is a self-contained radiotelegraph communication set providing medium- and high-frequency emergency communication facilities.

This equipment consists of two medium-frequency transmitters (one main and one emergency), an hf transmitter, an hf receiver, one receiver that can receive in both the low- and medium-frequency bands, an auto alarm, an auto alarm keyer, control panels, power components, antennas, and accessories.

The main medium-frequency transmitter and the hf transmitter are crystal-controlled. The emergency transmitter is master-oscillator controlled. The emergency transmitter is operated from a 12-volt storage battery (through a battery charger from the ship's line under normal conditions). The low- and medium-frequency receiver operates from a 12-volt storage battery and a 90-volt B battery, under emergency

conditions; normally it operates from the ship's line as does the rest of the equipment.

This equipment can be operated on ships that have either ac or dc power or a combination of the two.

TECHNICAL CHARACTERISTICS:

Frequency Range in Mc: 0.015 to 0.65 (low- and medium-freq rcvr); 0.085 to 0.55, 1.9 to 25 (hf rcvr); 0.35 to 0.515 (main and emer xmtr); 2 to 24 (hf xmtr)

Type Modulation: AM

Type of Signal: Cw, mcw

Power Output: 40 w (mcw, emer xmtr); 200 w (cw), 250 w (mcw) (main medium-freq xmtr); 300 w (cw, hf xmtr).

Power Requirements: 17.4 amp 115-v 60-cycle 1-phase ac (Code A); 11.3 amp, 115-v dc (Code A); 22 amp, 115-v 60-cycle 1-phase ac (Code B); 32 amp, 115-v dc (Code C); 22 amp, 230-v dc (Code D). For operation from 220 or 440-v ac, a step-down transformer is used; dc is supplied by a rotary converter

AN/SRC-7 RADIO SET**MAJOR COMPONENTS**

QTY	ITEM	STOCK NUMBERS	DIMENSIONS (Inches)	WEIGHT (Lbs)
(USA)				
1	Dynamotor power supply	3H1512-23		
1	Modulator-Power Supply MD-220/SRC-7	2C2510-220		
1	Power Supply PP-1068/SRC-7	3H4497-1068		
1	Power Supply PP-1069/SRC-7	3H4497-1069		
1	Power Supply PP-1070/SRC-7	3H4497-1070		
1	Power Supply PP-1071/SRC-7	3H4497-1071		
1	Radio Receiver R-597/SRC-7	2C4180-597		
1	Radio Receiver R-598/SRC-7	2C4180-598		
1	Radio Receiver R-599/SRC-7	2C4180-599		
1	Radio Transmitter T446/ SRC-7	2C6900A-446		
1	Radio Transmitter T-447/ SRC-7	2C6900A-447		
1	Radio Transmitter T-448/ SRC-7	2C6900A-448		

REFERENCE DATA AND LITERATURE:

Commercial instruction book

SHIPPING DATA

PKGS	VOLUME (Cu Ft)	WEIGHT (Lbs)
------	----------------	--------------

PROCUREMENT DATA

PROCURING SERVICE: USA
SPEC &/or DWG:

DESIGN COG: USA, Sig C

CONTRACTOR	LOCATION	CONTRACT OR ORDER NO.	APPROX UNIT COST
RCA—RCA Victor Division	New York, N. Y.	33761-P-53-36	\$5,445.00

RADIO SET AN/SRC-8()

1 July 1958

Cognizant Serv: USA FSN: AN/SRC-8: 5820-567-2387
 AN/SRC-8X: 5820-567-2388
 AN/SRC-8XX: 5820-567-2361
 AN/SRC-8Y: 5820-503-2580

USA

USN

USAF

TYPE CLASS:

Std

Std

STOCK NO:

AN/SRC-8: 2C5109-8

AN/SRC-8X: 2C5109-

8X

AN/SRC-8XX: 2C5109-

8XX

AN/SRC-8Y: 2C5109-

8Y



FUNCTIONAL DESCRIPTION:

Radio Set AN/SRC-8() (Ray Jefferson, Inc. Model 914 Radio Telephone) provides medium-frequency, two-way, ship-to-shore and ship-to-ship radiotelephone service for ships in coastwise waters.

This equipment consists of a transmitter, a receiver, an antenna, accessories, and power components.

The AN/SRC-8 and the AN/SRC-8X operate from a 115-volt dc and ac power source, respectively; the AN/SRC-8XX and AN/SRC-8Y operate respectively from 12-volt and 32-volt batteries.

TECHNICAL CHARACTERISTICS:

Frequency Range in Mc: 2 to 3

Type Modulation: AM

Type of Signal: Voice

Power Output: 50 w

Power Requirements:

AN/SRC-8: 115-v dc

AN/SRC-8X: 115-v 60-cycle ac

AN/SRC-8XX: 12-v dc

AN/SRC-8Y: 32-v dc

AN/SRC-8() RADIO SET

MAJOR COMPONENTS

QTY	ITEM	STOCK NUMBERS	DIMENSIONS (Inches)	WEIGHT (Lbs)
	<i>For AN/SRC-8:</i>			
		(FSN)		
1	Antenna AT-609/SRC-8	5280-697-7745		
1	Converter-Dynamotor PU-283/SRC-8	6125-392-7172		
1	Receiver-Transmitter RT-306/SRC	5280-569-0018	25-1/4 x 19-7/8 x 13	72
	<i>For AN/SRC-8X:</i>			
1	Antenna AT-609/SRC-8	5280-697-7745		
1	Power Supply PP-1055/SRC-8X	5280-643-0260		
1	Receiver-Transmitter RT-306/SRC	5280-569-0018	25-1/4 x 91-7/8 x 13	72
	<i>For AN/SRC-8XX:</i>			
1	Antenna AT-609/SRC-8	5280-697-7745		
1	Dynamotor DY-126/SRC-8XX	6125-521-0400		
	or			
1	Dynamotor DY-127/SRC-8XX	6125-521-0401		
1	Receiver-Transmitter RT-327/SRC	5280-510-1599	25-1/4 x 19-7/8 x 13	72
	<i>For AN/SRC-8Y:</i>			
1	Antenna AT-609/SRC-8	5280-697-7745		
1	Dynamotor DY-122/SRC-8Y	6125-521-0397		
	or			
1	Dynamotor DY-123/SRC-8Y	6125-521-7998		
1	Receiver-Transmitter RT-327/SRC	5280-510-1599	25-1/4 x 19-7/8 x 13	72

REFERENCE DATA AND LITERATURE:

TM 11-253

SHIPPING DATA

PKGS	VOLUME (Cu Ft)	WEIGHT (Lbs)
2	10.9	140

RADIO SET **AN/SRC-8()**

PROCUREMENT DATA

PROCURING SERVICE: USA
SPEC &/or DWG:

DESIGN COG: USA, Sig C

CONTRACTOR	LOCATION	CONTRACT OR ORDER NO.	APPROX UNIT COST
Munston Mfg. & Service, Inc.	Islip, L. I., N. Y.	28589-P-55-55 (AN/SRC-8A)	\$332.75

RADIO SET **AN/SRC-9**

1 July 1958

Cognizant Serv: USN FSN:

USA

USN

USAF

TYPE CLASS:

Used by

Used by

--

STOCK NO:

--

--

--

(No Illustration Available)

FUNCTIONAL DESCRIPTION:

Radio Set AN/SRC-9 (Mackay Type 402-A) is a non-portable, rugged, compact, lifeboat radiotelegraph transmitter-receiver designed for communication between survival craft and rescue vessels in the international distress frequency band and on the long-range frequency of 8,346 kc. The transmitter design assures effective use by personnel not trained in radio communication.

Manual keying for sending distress signals and for communication purposes is available. Also provided is automatic keying that transmits sequences of the International Auto Alarm Signal and SOS signals on 500 kc, followed on 8,364

kc by more SOS signals and by a long dash for direction-determining receivers.

All power required for operation of the equipment can be provided by a 12-volt storage battery.

TECHNICAL CHARACTERISTICS:*Frequency Range in Mc:*

Fixed Tuned: 0.492 to 0.508

Tunable: 8.1 to 8.9

Type Modulation: AM*Type of Signal:* Cw, mew*Power Output:* 30 w into 10-ohm, 100- μ f antenna on 500 kc;
40 w into 40-ohm antenna on 8,364 kc*Power Requirements:* 32 amp, 12-v dc from storage battery**MAJOR COMPONENTS**

QTY	ITEM	STOCK NUMBERS	DIMENSIONS (Inches)	WEIGHT (Lbs)
1	Radio Set AN/SRC-9 (Equipment consists of only one major component.)	-----	22 x 21 x 15	92

REFERENCE DATA AND LITERATURE:

NAVSHIPS 92364

SHIPPING DATA

PKGS	VOLUME (Cu Ft)	WEIGHT (Lbs)

MIL-HDBK-161

AN/SRC-9 RADIO SET

PROCUREMENT DATA

PROCURING SERVICE: USN
SPEC &/or DWG: BuShips R-1472

DESIGN COG: USN, BuShips

CONTRACTOR	LOCATION	CONTRACT OR ORDER NO.	APPROX UNIT COST
Mackay Radio & Telegraph Co., Inc.	New York, N. Y.	NObsr-64203	

RADIO SET AN/SRC-10, -10X, -10Y, -11, -11X, -11Y, -12, -12X, -12Y

Cognizant Serv: USN FSN:

USA

USN

USAF

TYPE CLASS:

--

Used by

--

STOCK NO:

--

--

--

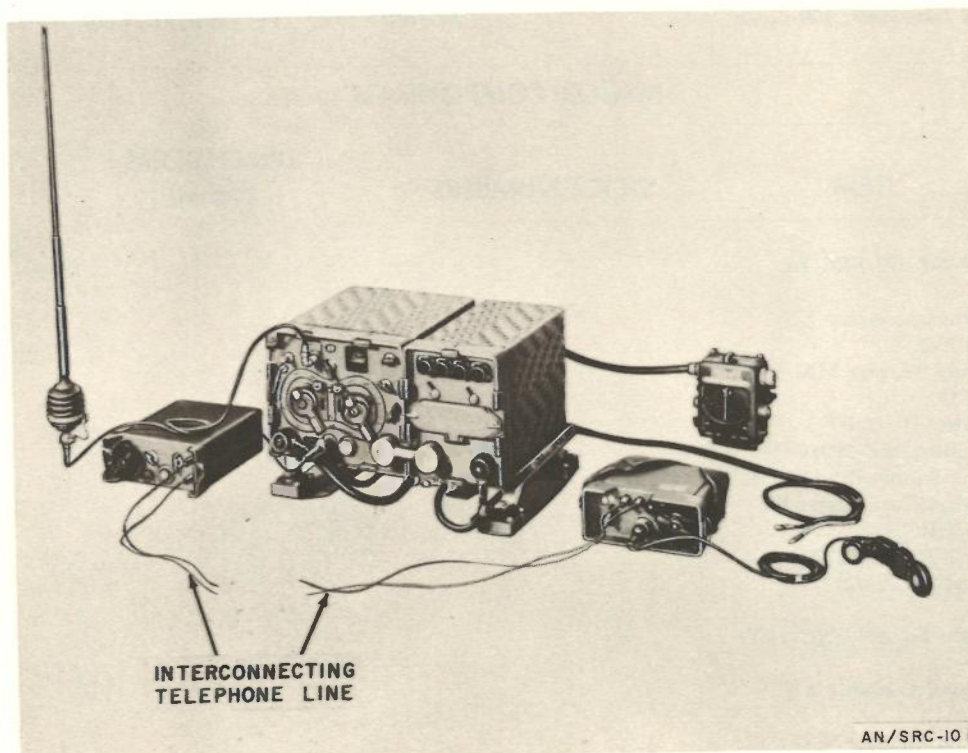

FUNCTIONAL DESCRIPTION:

Radio Sets AN/SRC-10, AN/SRC-10X, AN/SRC-10Y, AN/SRC-11, AN/SRC-11X, AN/SRC-11Y, AN/SRC-12, AN/SRC-12X, and AN/SRC-12Y are designed to provide frequency modulated radiotelephone facilities within the frequency range of 20 to 54.9 megacycles. Each receiver-transmitter covers a specific portion of the over-all frequency range.

These equipments can be installed and operated in trucks, personnel carriers, armored utility vehicles, weapon carriers, and other authorized vehicles.

The radio sets are primarily intended for short range operation and are shipboard installed for amphibious communications.

Radio Sets AN/SRC-10, AN/SRC-10X, AN/SRC-10Y, AN/SRC-11, AN/SRC-11X, AN/SRC-11Y, AN/SRC-12, AN/SRC-12X, and AN/SRC-12Y are nomenclatures that

have been assigned to identify the United States Navy equivalent to United States Army Radio Sets AN/VRC-8, AN/VRC-9, and AN/VRC-10.

TECHNICAL CHARACTERISTICS:

Frequency Range in Mc:

AN/SRC-10, -10X, -10Y: 20 to 27.9

AN/SRC-11, -11X, -11Y: 27 to 38.9

AN/SRC-12, -12X, -12Y: 38 to 54.9

Type of Emission and Reception: Voice and 1,600 cps FM signals

Type of Tuning: Continuous or channel selection

Number of Frequency Channels:

AN/SRC-10, -10X, -10Y: 80

AN/SRC-11, -11X, -11Y: 120

AN/SRC-12, 12X, -12Y: 170

Channel Spacing: 100 kc

AN/SRC-10, -10X, -10Y, -11, -11X, RADIO SET -11Y, -12, -12X, -12Y

Presetting: Any 2 channels

Operational Range: 10 to 15 miles

Receiver Type: Double conversion superheterodyne

Receiver Sensitivity: 30 db signal plus noise-to-noise ratio with 1/2 uv input signal

Audio Output Impedance: 600 ohms at all audio output terminals

Microphone Input Impedance: 150 ohms

Power Output:

Transmitter: High 16 w, low 2 w (approximately)

Receiver: 1 w into 600 ohm phones (a third output of approximately 30 mw at fixed level output is not used)

Power Requirements:

AN/SRC-10, -11, -12: 24 v dc

AN/SRC-10X, -11X, -12X: 12 v dc

AN/SRC-10Y, -11Y, -12Y: 115-v 60-cycle 1-phase ac

MAJOR COMPONENTS

QTY	ITEM	STOCK NUMBERS	DIMENSIONS (Inches)	WEIGHT (Lbs)
<i>For Radio Set AN/SRC-10:</i>				
1	Antenna Assembly AN/ SRA-3			
1	Control Adapter MX-1583/ SRC			
1*	Handset H-33/PT	-----	2-1/16 x 3 x 3	2
1	Mounting MT-299/GR	-----	4 x 13 x 20	24
1	Power Supply PP-112/GR	-----	8 x 9 x 13	33
1	Receiver-Transmitter RT- 66/GRC	-----	9 x 11-1/4 x 13	35
1	Special Purpose Cable As- sembly CX-1211/U	-----		.4
<i>For Radio Set AN/SRC-10X:</i>				
1	Antenna Assembly AN/ SRA-3			
1	Control Adapter MX-1583/ SRC			
1*	Handset H-33/PT	-----	2-1/16 x 3 x 3	2
1	Mounting MT-299/GR	-----	4 x 13 x 20	24
1	Power Supply PP-109/GR	-----	8 x 9 x 13	33
1	Receiver-Transmitter RT- 66/GRC	-----	9 x 11-1/4 x 13	35
1	Special Purpose Cable As- sembly CX-1211/U	-----		.4
<i>For Radio Set AN/SRC-10Y:</i>				
1	Antenna Assembly AN/ SRA-3			
1	Control Adapter MX-1986/ SRC			
1*	Handset H-33/PT	-----	2-1/16 x 3 x 3	2
1	Mounting MT-299/GR	-----	4 x 13 x 20	24
1	Power Supply PP-1175/SR	-----	7-5/16 x 9-1/4 x 12-7/8	
1	Receiver-Transmitter R- 66/GRC	-----	9 x 11-1/4 x 13	35

RADIO SET AN/SRC-10, -10X, -10Y, -11, -11X,
-11Y, -12, -12X, -12Y

MAJOR COMPONENTS—Continued

QTY	ITEM	STOCK NUMBERS	DIMENSIONS (Inches)	WEIGHT (Lbs)
1	Special Purpose Cable Assembly CX-1211/U	-----	-----	4
	<i>For Radio Set AN/SRC-11:</i>			
1	Antenna Assembly AN/SRA-3	-----	-----	
1	Control Adapter MX-1583/SRC	-----	-----	
1*	Handset H-33/PT	-----	2-1/16 x 3 x 3	2
1	Mounting MT-299/GR	-----	4 x 13 x 20	24
1	Power Supply PP-112/GR	-----	8 x 9 x 13	33
1	Receiver-Transmitter RT-67/GR	-----	9 x 11-1/4 x 13	35
1	Special Purpose Cable Assembly CX-1211/U	-----	-----	.4
	<i>For Radio Set AN/SRC-11X:</i>			
1	Antenna Assembly AN/SRA-3	-----	-----	
1	Control Adapter MX-1583/SRC	-----	-----	
1*	Handset H-33/PT	-----	2-1/16 x 3 x 3	2
1	Mounting MT-299/GR	-----	4 x 13 x 20	24
1	Power Supply PP-109/GR	-----	8 x 9 x 13	33
1	Receiver-Transmitter R-67/GRC	-----	9 x 11-1/4 x 13	35
1	Special Purpose Cable Assembly CX-1211/U	-----	-----	.4
	<i>For Radio Set AN/SRC-11Y:</i>			
1	Antenna Assembly AN/SRA-3	-----	-----	
1	Control Adapter MX-1986/SRC	-----	-----	
1*	Handset H-33/PT	-----	2-1/16 x 3 x 3	2
1	Mounting MT-299/GR	-----	4 x 13 x 20	24
1	Power Supply PP-1175/SR	-----	7-5/16 x 9-1/4 x 12-7/8	
1	Receiver-Transmitter RT-67/GRC	-----	9 x 11-1/4 x 13	35
1	Special Purpose Cable Assembly CX-1211/U	-----	-----	.4
	<i>For Radio Set AN/SRC-12:</i>			
1	Antenna Assembly AN/SRA-3	-----	-----	

AN/SRC-10, -10X, -10Y, -11, -11X, RADIO SET
-11Y, -12, -12X, -12Y

MAJOR COMPONENTS—Continued

QTY	ITEM	STOCK NUMBERS	DIMENSIONS (Inches)	WEIGHT (Lbs)
1	Control Adapter MX-1583/ SRC			
1*	Handset H-33/PT	-----	2-1/16 x 3 x 3	2
1	Mounting MT-299/GR	-----	4 x 13 x 20	24
1	Power Supply PP-112/GR	-----	8 x 9 x 13	33
1	Receiver-Transmitter RT- 68/GRC	-----	9 x 11-1/4 x 13	35
1	Special Purpose Cable As- sembly CX-1211/U	-----		.4
<i>For Radio Set AN/SRC-12X:</i>				
1	Antenna Assembly AN/ SRA-3			
1	Control Adapter MX-1583/ SRC			
1*	Handset H-33/PT	-----	2-1/16 x 3 x 3	2
1	Mounting MT-299/GR	-----	4 x 13 x 20	24
1	Power Supply PP-109/GR	-----	8 x 9 x 13	33
1	Receiver-Transmitter RT- 68/GRC	-----	9 x 11-1/4 x 13	35
1	Special Purpose Cable As- sembly CX-1211/U	-----		.4
<i>For Radio Set AN/SRC-12Y:</i>				
1	Antenna Assembly AN/ SRA-3			
1	Control Adapter MX-1986/ SRC			
1*	Handset H-33/PT	-----	2-1/16 x 3 x 3	2
1	Mounting MT-299/GR	-----	4 x 13 x 20	24
1	Power Supply PP-1175/SR	-----	7-5/16 x 9-1/4 x 12-7/8	
1	Receiver-Transmitter RT- 68/GRC	-----	9 x 11-1/4 x 13	35
1	Special Purpose Cable As- sembly CX-1211/U	-----		.4

* One additional Handset H-33/PT should be supplied for each control box installed.

REFERENCE DATA AND LITERATURE:

TM 11-286; BuShips Ltr S67/1-7 Ser 881E-1-3528, 1 September 1956

RADIO SET AN/SRC-10, -10X, -10Y, -11, -11X,
-11Y, -12, -12X, -12Y

SHIPPING DATA

PKGS	VOLUME (Cu Ft)	WEIGHT (Lbs)
------	----------------	--------------

PROCUREMENT DATA

PROCURING SERVICE: USN
SPEC &/or DWG:

DESIGN COG: USA, Sig C

CONTRACTOR	LOCATION	CONTRACT OR ORDER NO.	APPROX UNIT COST
DeJur-Amsco Corp.	Long Island City, New York, N. Y.	DA-36-039-SC-47969	
Signal Corps Supply Agency	Philadelphia, Pa.	MIPR 800-29092-52, 23 June 1952	

