

30 August 1965

Cog Service: USN FSN:

RADIO RECEIVING EQUIPMENT AN/ARR-2  
Functional Class:

USA

USN

USAF

TYPE CLASS:

Used by

MANUFACTURER'S NAME/CODE NUMBER: Western Electric Company, Incorporated, (64959).

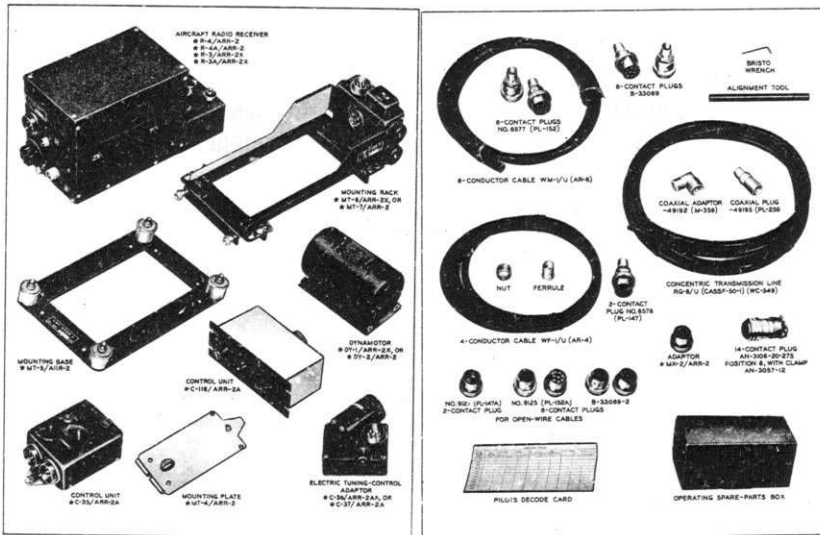

RADIO RECEIVING EQUIPMENT AN/ARR-2

**FUNCTIONAL DESCRIPTION:**

Radio Receiving Equipment AN/ARR-2 is designed as a special purpose radio receiving equipment used to receive a particular type of ultra-high-frequency (UHF) signal in the range of 234 to 258 megacycles. The signal must have a modulation at a lower radio frequency, which usually is keyed telegraphically but may be amplitude modulated in turn by a voice signal. The modulation may be set at any one of six frequencies in the range of 540 to 830 kilocycles.

The AN/ARR-2 is designed for remote control operation only.  
No field changes in effect at time of preparation (6 August 1965).

**RELATION TO OTHER EQUIPMENT:**

The AN/ARR-2, -2A and AN/ARR-2X, -2AX are basically the same except for a 28 v system for the former and a 14 v system for the latter.

## RADIO RECEIVING EQUIPMENT AN/ARR-2

### EQUIPMENT REQUIRED BUT NOT SUPPLIED:

(1) Antenna AT-5/ARR-1 w/coaxial plugs 49195 and 49192; (1) DC Power Supply, 28 v; (1) Head-set; (1) LM Series Frequency Measuring Equipment or Frequency Meter BC-221-( ); (1) Test Oscillator TS-24/ARR-2 or TS-24A/ARR-2 w/Slip Cover CW-8/ARR-2.

### TECHNICAL CHARACTERISTICS:

#### FREQUENCY RANGE

HIGH FREQUENCY: 234 to 258 mc.

SUPERIMPOSED MODULATION FREQUENCY: The receiver will respond at any one of six preset freq within the range of 540 to 830 kc.

INTERMEDIATE FREQUENCY: . 200 kc.

FREQUENCY STABILITY OF BEAT NOTE: Less than 1000 cps drift over a temp range of - 40° C to + 55° C ambient; less than 1000 cps change when the battery v is varied from 28 to 22 v and 28 to 30 v.

ANTENNA: Quarter-wave type.

#### OUTPUT IMPEDANCE (LOOKING INTO RECEIVER)

##### FREQUENCY

200 KC: 660 ohms on 330 ohm tap; 13000 ohms on 4000 ohm tap.

400 KC: 1200 ohms on 330 ohm tap; 21000 ohms on 4000 ohm tap.

1000 KC: 1700 ohms on 330 ohm tap; 22000 ohms on 4000 ohm tap.

2000 KC: 730 ohms on 330 ohm tap; 12500 ohms on 4000 ohm tap.

3000 KC: 340 ohms on 330 ohm tap; 4400 ohms on 4000 ohm tap.

#### POWER OUTPUT

CW: 500 mw.

MCW: 900 mw.

BEAT NOTE OSCILLATOR: Freq adjustment ± 2.5 kc at 28 v input, 77° F (25° C).

SENSITIVITY FROM TEST POINT: 30% modulation at 710 kc equip set for voice, 450 mv for an output of 1.7 v across a 300 ohm line or 6.3 v across 4000 ohms.

POWER REQUIREMENTS: 28 v dc, 1.6 amp total.

### MAJOR COMPONENTS

QTY	ITEM	STOCK NUMBERS	DIMENSIONS (INCHES)	WEIGHT (LBS)
1	Radio Receiving Equipment AN/ARR-2 includes:			
1	Radio Receiver R-4/ARR-2		4-27/32 x 5-11/16 x 12-1/16	6.5
1	Mounting Rack MT-7/ARR-2		4-1/2 x 6-1/8 x 13-1/4	1.4
1	Mounting Base MT-5/ARR-2		1-3/4 x 7 x 10-3/4	0.9
1	Dynamotor DY-2/ARR-2 or DY-2B/ARR-2		2-23/32 x 3-9/32 x 4-13/16	3.0
1	Control Unit C-2/ARR-2		3 x 3-3/8 x 5-15/32	1.3
1	Control Unit Mounting Plate MT-4/ARR-2		1/16 x 3-9/16 x 5-9/16	0.2
1	Adapter MX-2/ARR-2		1-7/32 dia	0.12
1	Coaxial Plug 49195 or PL-259		13/16 dia	0.06
*1	Plug (2 contacts) PL-147, PL-147A, 6578, or 9127		1-7/32 dia	0.12

**RADIO RECEIVING EQUIPMENT AN/ARR-2**

QTY	ITEM	STOCK NUMBERS	DIMENSIONS (INCHES)	WEIGHT (LBS)
*2	Plug (8 contacts) PL-152, PL-152A, 6577, or 9125		1-7/32 dia	0.12
1	Right Angle Adapter for Me- chanical Linkage MX-22/ARR-2, ML-211-A		5/8 x 1-11/32 x 1-19/32	
1	Concentric Transmission Line RG-B/U		0.41 dia x 15 ft	1.65
1	Mechanical Linkage 6151 or Tuning Shaft MC-215 (com- plete w/end fittings)		5/8 dia	
*1	Cable (4 conductors) WF-1/U		1/2 x 5 ft	0.75
*1	Cable (8 conductors) WM-1/U		1/2 dia x 10 ft	1.70
3	Decode Cards			

\* Furnished as required for open wire installation or by cables.

**REFERENCE DATA AND LITERATURE:**

AN16-30ARR2-2: Handbook Maintenance Instructions Aircraft Radio Receiving Equipment AN/ARR-2,  
AN/ARR-2A, AN/ARR-2X, AN/ARR-2AX.

**TUBE, CRYSTAL AND/OR SEMI-CONDUCTOR DATA:**

TUBES: (1) 12A6 (7) 9001 (3) 6AK5

CRYSTALS: Not required.

SEMI-CONDUCTORS: Not required.

**SHIPPING DATA**

PKGS	VOLUME (CU FT)	WEIGHT (LBS)
------	----------------	--------------

**PROCUREMENT DATA**

PROCURING SERVICE: USN  
SPEC &/OR DWG: RE-13A578C

DESIGN COG: USN, BuWeps

CONTRACTOR	LOCATION	CONTRACT OR ORDER NO.	APPROX. UNIT COST
Western Electric Co., Inc.	New York, New York	NXS-4967	

26 August 1965  
Cog Service: USN

FSN:

RADIO RECEIVING EQUIPMENT AN/ARR-2A  
Functional Class:

USA

USN

USAF

TYPE CLASS:

Used by

MANUFACTURER'S NAME/CODE NUMBER: Western Electric Co., Inc., (64959).

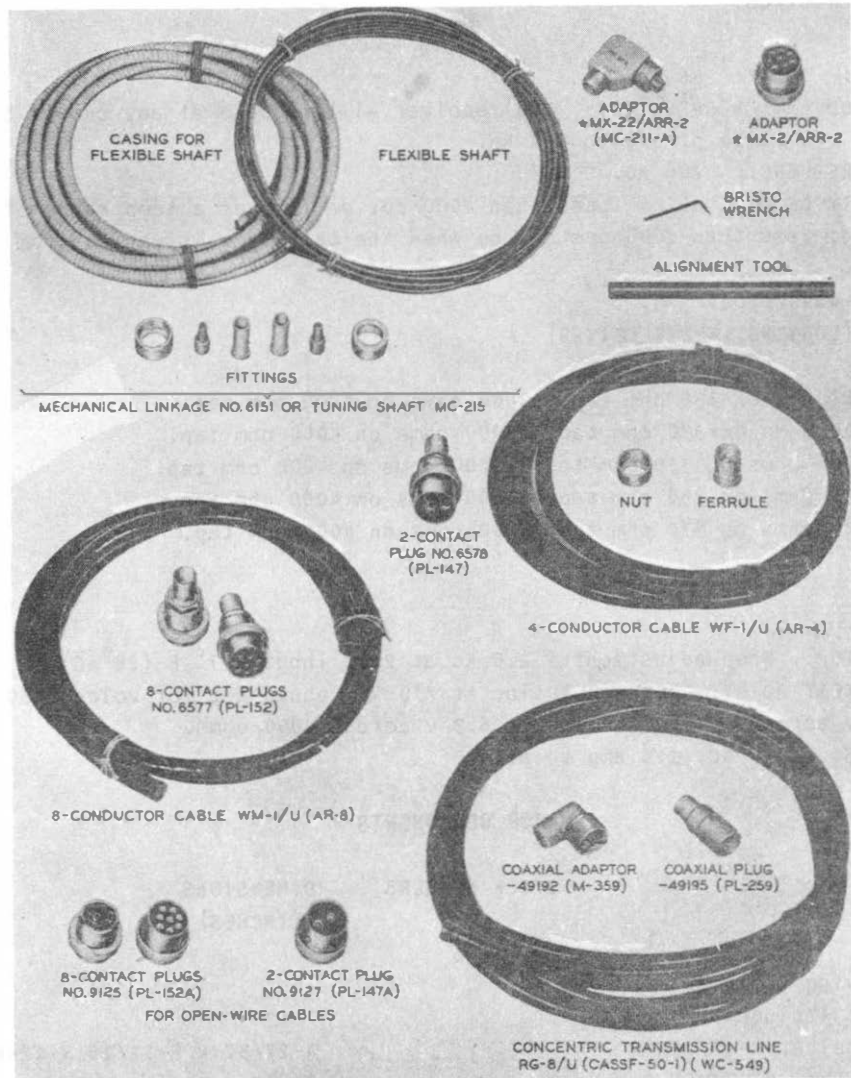

RADIO RECEIVING EQUIPMENT AN/ARR-2A

#### FUNCTIONAL DESCRIPTION:

Radio Receiving Equipment AN/ARR-2A is designed as a special purpose radio receiving equipment used to receive a particular type of ultra-high-frequency (UHF) signal in the range of 234 to 258 megacycles. The signal must have a modulation at a lower radio frequency, which usually is keyed telegraphically but may be amplitude modulated in turn by a voice signal. The modulation may be set at any one of six frequencies in the range of 540 to 830 kilocycles.

The AN/ARR-2A is designed for remote control operation only.

No field changes in effect at time of preparation (5 August 1965).

## RADIO RECEIVING EQUIPMENT AN/ARR-2A

### RELATION TO OTHER EQUIPMENT:

The AN/ARR-2, -2A and AN/ARR-2X, -2AX are basically the same except for a 28 v system for the former and a 14 v system for the latter.

### EQUIPMENT REQUIRED BUT NOT SUPPLIED:

(1) Antenna AT-5/ARR-1 w/coaxial Plugs 49195 and 49192, (1) DC Power Supply, 28 v, (1) Headset, (1) LM Swries Frequency Measuring Equipment or Frequency Meter, BC-221-( ), (1) Test Oscillator TS-24/ARR-2 or TS-24A/ARR-2 w/Strip Cover CW-8/ARR-2.

### TECHNICAL CHARACTERISTICS:

#### FREQUENCY RANGE

HIGH FREQUENCY: 234 to 258 mc.

SUPERIMPOSED MODULATION FREQUENCY: The receiver will respond at any one of six preset freq within the range of 540 to 830 kc.

INTERMEDIATE FREQUENCY: 200 kc.

FREQUENCY STABILITY OF BEAT NOTE: Less than 1000 cps drift over a temp range of - 40° C to + 55° C ambient; Less than 1000 cps change when the battery v is varied from 28 to 22 v and 28 to 30 v.

ANTENNA: Quarter-wave type.

#### OUTPUT IMPEDANCE (LOOKING INTO RECEIVER)

##### FREQUENCY

200 KC: 660 ohms on 330 ohm tap; 13000 ohms on 4000 ohm tap.

400 KC: 1200 ohms on 330 ohm tap; 21000 ohms on 4000 ohm tap.

1000 KC: 1700 ohms on 330 ohm tap; 22000 ohms on 4000 ohm tap.

2000 KC: 730 ohms on 330 ohm tap; 12500 ohms on 4000 ohm tap.

3000 KC: 340 ohms on 330 ohm tap; 4400 ohms on 4000 ohm tap.

#### POWER OUTPUT

CW: 500 mw.

MCW: 900 mw.

BEAT NOTE OSCILLATOR: Freq adjustment ± 2.5 kc at 28 v input, 77° F (25° C).

SENSITIVITY FROM TEST POINT: 30% Modulation at 710 kc, equip set for voice, 450 mv for an output of 1.7 v across a 300 ohm line or 6.3 v across 4000 ohms.

POWER REQUIREMENTS: 28 v dc, 1.6 amp total.

### MAJOR COMPONENTS

QTY	ITEM	STOCK NUMBERS	DIMENSIONS (INCHES)	WEIGHT (LBS)
1	Radio Receiving Equipment AN/ARR-2A includes:			
1	Radio Receiver R-4A/ARR-2		4-27/32 x 5-11/16 x 12-1/16	6.5
1	Mounting Rack MT-7/ARR-2		4-1/2 x 6-1/8 x 13-1/4	1.4
1	Mounting Base MT-5/ARR-2		1-3/4 x 7 x 10-3/4	0.9
1	Dynamotor DY-2/ARR-2 or DY-2B/ARR-2		2-23/32 x 3-9/32 x 4-13/16	3.0
1	Control Unit C-35/ARR-2A or C-116/ARR-2A		2-15/32 x 3-3/8 x 5-15/32	0.9
1	Control Unit Mounting Plate MT-4/ARR-2 (furnished w/C-35/ARR-2A only)		1/16 x 3-9/16 x 5-9/16	0.2
1	Electric Tuning Control Adapter C-37/ARR-2A		1-19/32 x 3-13/64 x 4-3/16	0.94

1.4 AN/ARR-2A: 2

**RADIO RECEIVING EQUIPMENT AN/ARR-2A**

QTY	ITEM	STOCK NUMBERS	DIMENSIONS (INCHES)	WEIGHT (LBS)
1	Adapter MX-2/ARR-2		1-7/32 dia	0.12
1	Coaxial Plug 49195 or PL-259		13/16 dia	0.06
*1	Plug (2-contacts) PL-147, PL-147A, 6578 or 9127		1-7/32 dia	0.12
*2	Plug (8-contacts) PL-152, PL-152A, 6577 or 9125		1-7/32 dia	0.12
*2	Plug (8-contacts) B-33069 or B-33069-2		1-7/32 dia	0.12
*1	Plug (14-contacts) AN-3106-20-27S-Pos B		1-1/2 dia	0.18
*1	Clamp for Plug AN-3057-12			
1	Right Angle Coaxial Adaptor 49192 or M-359		13/16 dia	0.1
1	Concentric Transmission Line RG-8/U		0.41 dia x 15 ft	1.65
*1	Cable (4-conductors) WF-1/U		1/2 dia x 5 ft	0.75
*1	Cable (8-conductors) WM-1/U		1/2 dia x 20 ft	3.40
3	Decode Cards			

\* Furnished as required for open wire installation or by cables.

**REFERENCE DATA AND LITERATURE:**

AN16-30ARR2-2: Handbook Maintenance Instructions Aircraft Radio Receiving Equipment AN/ARR-2, AN/ARR-2A, AN/ARR-2X, AN/ARR-2AX.

**TUBE, CRYSTAL AND/OR SEMI-CONDUCTOR DATA:**

TUBES: (1) 12A6 (7) 9001 (3) 6AK5

CRYSTALS: Not required.

SEMI-CONDUCTORS: Not required.

**SHIPPING DATA**

PKGS	VOLUME (CU. FT)	WEIGHT (LBS)
------	-----------------	--------------

**PROCUREMENT DATA**

PROCURING SERVICE: USN  
SPEC &/OR DWG: RE13A578C

DESIGN COG: USN, BuWeps

---

RADIO RECEIVING EQUIPMENT AN/ARR-2A

---

CONTRACTOR	LOCATION	CONTRACT OR ORDER NO.	APPROX. UNIT COST
Western Electric Co., Inc.	New York, N.Y.	NXsa 38075	

26 August 1965

Cog Service: USN

FSK:

RADIO RECEIVING EQUIPMENT AN/ARR-2AX

Functional Class:

USA

USN

USAF

TYPE CLASS:

Used by

MANUFACTURER'S NAME/CODING NUMBER: Western Electric Co., Inc., (64959).

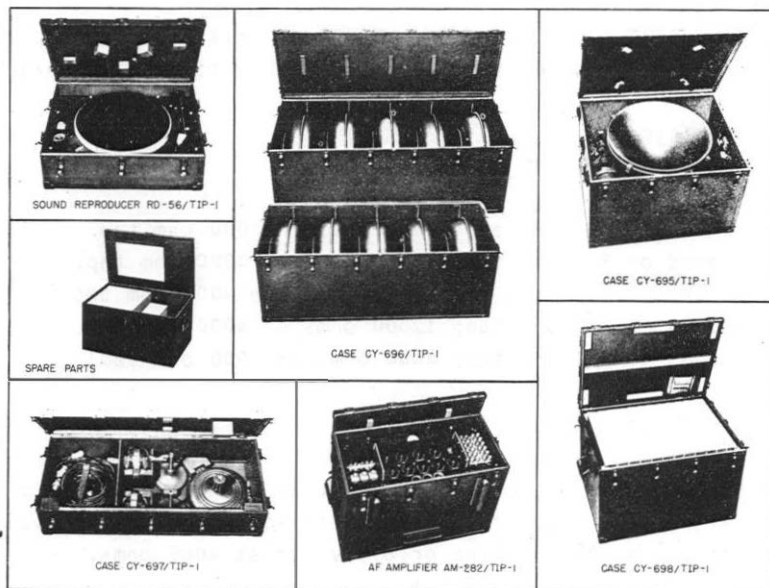

#### RADIO RECEIVING EQUIPMENT AN/ARR-2AX

#### FUNCTIONAL DESCRIPTION:

Radio Receiving Equipment AN/ARR-2AX is designed as a special purpose radio receiving equipment used to receive a particular type of ultra-high-frequency (UHF) signal in the range of 234 to 258 megacycles. The signal must have a modulation at a lower radio frequency, which usually is keyed telegraphically but may be amplitude modulated in turn by a voice signal. The modulation may be set at any one of six frequencies in the range of 540 to 830 kilocycles.

The AN/ARR-2AX is designed for remote control operation only.

No field changes in effect at time of preparation (6 August 1965).

#### RELATION TO OTHER EQUIPMENT:

The AN/ARR-2, -2A and AN/ARR-2X, -2AX are basically the same except for a 28 v system for the former and a 14 v system for the latter.

1.4 AN/ARR-2AX: 1



**RADIO RECEIVING EQUIPMENT AN/ARR-2AX**

**EQUIPMENT REQUIRED BUT NOT SUPPLIED:**

- (1) Antenna AT-5/ARR-1 w/coaxial plugs 49195 and 49192; (1) DC Power Supply, 14 v;
- (1) Headset; (1) LM Series Frequency Measuring Equipment or Frequency Meter BC-221-( );
- (1) Test Oscillator TS-24/ARR-2 or TS-24A/ARR-2 w/Slip Cover CW-8/ARR-2.

**TECHNICAL CHARACTERISTICS:**

**FREQUENCY RANGE**

HIGH FREQUENCY: 234 to 258 mc.

SUPERIMPOSED MODULATION FREQUENCY: The receiver will respond at any one of six preset freq within the range of 540 to 830 kc.

INTERMEDIATE FREQUENCY: 200 kc.

FREQUENCY STABILITY OF BEAT NOTE: Less than 1000 cps drift over a temp range of - 40° C to + 55° C ambient; Less than 1000 cps change when the battery v is varied from 14 to 11 v and 14 to 15 v.

ANTENNA: Quarter-wave type.

**OUTPUT IMPEDANCE (LOOKING INTO RECEIVER)**

**FREQUENCY**

200 KC: 660 ohms on 330 ohm tap; 13000 ohms on 4000 ohm tap.

400 KC: 1200 ohms on 330 ohm tap; 21000 ohms on 4000 ohm tap.

1000 KC: 1700 ohms on 330 ohm tap; 22000 ohms on 4000 ohm tap.

2000 KC: 730 ohms on 330 ohm tap; 12500 ohms on 4000 ohm tap.

3000 KC: 340 ohms on 330 ohm tap; 4400 ohms on 4000 ohm tap.

**POWER OUTPUT**

CW: 500 mw.

MCW: 900 mw.

BEAT NOTE OSCILLATOR: Freq adjustment ± 2.5 kc at 28 v input, 77° F (25° C).

SENSITIVITY FROM TEST POINT: 30% modulation at 710 kc, equip set for voice, 120 mv for an output of 1.7 v across a 300 ohm line or 6.3 v across 4000 ohms.

POWER REQUIREMENTS: 14 v dc, 3.1 amp total.

**MAJOR COMPONENTS**

QTY	ITEM	STOCK NUMBERS	DIMENSIONS (INCHES)	WEIGHT (LBS)
1	Radio Receiving Equipment AN/ARR-2AX includes:			
1	Radio Receiver R-3A/ARR-2X		4-27/32 x 5-11/16 x 12-1/16	6.5
1	Mounting Rack MT-6/ARR-2X		4-1/2 x 6-1/8 x 13-1/4	1.4
1	Mounting Base MT-5/ARR-2		1-3/4 x 7 x 10-3/4	0.9
1	Dynamotor DY-1/ARR-2X		2-23/32 x 3-9/32 x 4-13/16	3.0
1	Control Unit C-35/ARR-2A or C-116/ARR-2A		2-15/32 x 3-3/8 x 5-15/32	0.9
1	Control Unit Mounting Plate MT-4/ARR-2 (furnished w/C-35/ARR-2A only)		1/16 x 3-9/16 x 5-9/16	0.2
1	Electric Tuning Control Adapter C-36/ARR-2AX		1-19/32 x 3-13/64 x 4-3/16	0.94
1	Adapter MX-2/ARR-2		1-7/32 dia	0.12

1.4 AN/ARR-2AX: 2

**RADIO RECEIVING EQUIPMENT AN/ARR-2AX**

QTY	ITEM	STOCK NUMBERS	DIMENSIONS (INCHES)	WEIGHT (LBS)
1	Coaxial Plug 49195 or PL-259		13/16 dia	0.06
*1	Plug (2 contacts) PL-147, PL-147A, 6578 or 9127		1-7/32 dia	0.12
*2	Plug (8 contacts) PL-152, PL-152A, 6577 or 9125		1-7/32 dia	0.12
*2	Plug (8 contacts) B-33069 or B-33069-2		1-7/32 dia	0.12
*1	Plug (14 contacts) AN-3106-20-27 Pos 8		1-1/2 dia	0.18
1	Clamp for Plug AN-3057-12			
1	Right Angle Coaxial Adapter 49192 or M-359		13/16 dia	0.1
1	Concentric Transmission Line RG-8/U		0.41 dia x 15 ft	1.65
*1	Cable (4 conductors) WF-1/U		1/2 dia x 5 ft	0.75
*1	Cable (8 conductors) WM-1/U		1/2 dia x 20 ft	3.40
3	Decode Cards			

\*Furnished as required for open wire installation or by cables.

**REFERENCE DATA AND LITERATURE:**

AN16-30ARR2-2: Handbook Maintenance Instructions Aircraft Radio Receiving Equipment AN/ARR-2,  
AN/ARR-2A, AN/ARR-2X, AN/ARR-2AX.

**TUBE, CRYSTAL AND/OR SEMI-CONDUCTOR DATA:**

TUBES: (1) 12A6 (7) 9001 (3) 6AK5

CRYSTALS: Not required.

SEMI-CONDUCTORS: Not required.

**SHIPPING DATA**

PKGS	VOLUME (CU FT)	WEIGHT (LBS)
------	----------------	--------------

**PROCUREMENT DATA**

PROCURING SERVICE: USN  
SPEC &/OR DWG: RE-13A578C

DESIGN COG: USN, BuWeps

CONTRACTOR	LOCATION	CONTRACT OR ORDER NO.	APPROX. UNIT COST
Western Electric Co., Inc.	New York, N. Y.	NXsa 38075	

30 August 1965

Cog Service: USN FSN:

RADIO RECEIVING EQUIPMENT AN/ARR-2X  
Functional Class:

USA

USN

USAF

TYPE CLASS:

Used by

MANUFACTURER'S NAME/CODE NUMBER: Western Electric Company, Inc., (64959).



RADIO RECEIVING EQUIPMENT AN/ARR-2X

**FUNCTIONAL DESCRIPTION:**

Radio Receiving Equipment AN/ARR-2X is designed as a special purpose radio receiving equipment used to receive a particular type of ultra-high-frequency (UHF) signal in the range of 234 to 258 megacycles. The signal must have a modulation at a lower radio frequency, which usually is keyed telegraphically but may be amplitude modulated in turn by a voice signal. The modulation may be set at any one of six frequencies in the range of 540 to 830 kilocycles.

The AN/ARR-2X is designed for remote control operation only.

No field changes in effect at time of preparation (6 August 1965).

**RELATION TO OTHER EQUIPMENT:**

The AN/ARR-2, -2A and AN/ARR-2X, -2AX are basically the same except for a 28 v system for the former and a 14 v system for the latter.

1.4 AN/ARR-2X: 1

## RADIO RECEIVING EQUIPMENT AN/ARR-2X

### EQUIPMENT REQUIRED BUT NOT SUPPLIED:

(1) Antenna AT-5/ARR-1 w/Coaxial Plugs 49195 and 49192; (1) DC Power Supply, 14 v; (1) Head-set; (1) LM Series Frequency Measuring Equipment or Frequency Meter 8C-221-( ); (1) Test Oscillator TS-24/ARR-2 or TS-24A/ARR-2 w/Slip Cover CW-8/ARR-2.

### TECHNICAL CHARACTERISTICS:

#### FREQUENCY RANGE

HIGH FREQUENCY: 234 to 258 mc.

SUPERIMPOSED MODULATION FREQUENCY: The receiver will respond at any one of six preset freq within the range of 540 to 830 kc.

INTERMEDIATE FREQUENCY: 200 kc.

FREQUENCY STABILITY OF BEAT NOTE: Less than 1000 cps drift over a temp range of - 40° C to + 55° C ambient; less than 1000 cps change when the battery v is varied from 14 to 11 v and 14 to 15 v.

ANTENNA: Quarter-wave type.

#### OUTPUT IMPEDANCE (LOOKING INTO RECEIVER)

##### FREQUENCY

200 KC: 660 ohms on 330 ohm tap; 13000 ohms on 4000 ohm tap.

400 KC: 1200 ohms on 330 ohm tap; 21000 ohms on 4000 ohm tap.

1000 KC: 1700 ohms on 330 ohm tap; 22000 ohms on 4000 ohm tap.

2000 KC: 730 ohms on 330 ohm tap; 12500 ohms on 4000 ohm tap.

3000 KC: 340 ohms on 330 ohm tap; 4400 ohms on 4000 ohm tap.

#### POWER OUTPUT

CW: 500 mw.

MCW: 900 mw.

BEAT NOTE OSCILLATOR: Freq adjustment  $\pm 2.5$  kc at 28 v input, 77° F (25° C).

SENSITIVITY FROM TEST POINT: 30% modulation at 710 kc, equip set for voice, 120 mv for an output of 1.7 v across a 300 ohm line or 6.3 v across 4000 ohms.

POWER REQUIREMENTS: 14 v dc, 3.1 amp total.

### MAJOR COMPONENTS

QTY	ITEM	STOCK NUMBERS	DIMENSIONS (INCHES)	WEIGHT (LBS)
1	Radio Receiving Equipment AN/ARR-2X includes:			
1	Radio Receiver R-3/ARR-2X		4-27/32 x 5-11/16 x 12-1/16	6.5
1	Mounting Rack MT-6/ARR-2X		4-1/2 x 6-1/8 x 13-1/4	1.4
1	Mounting Base MT-5/ARR-2		1-3/4 x 7 x 10-3/4	0.9
1	Dynamotor DY-1/ARR-2X		2-23/32 x 3-9/32 x 4-13/16	3.0
1	Control Unit C-2/ARR-2		3 x 3-3/8 x 5-15/32	1.3
1	Control Unit Mounting Plate MT-4/ARR-2		1/16 x 3-9/16 x 5-9/16	0.2
1	Adapter MX-2/ARR-2		1-7/32 dia	0.12
1	Coaxial Plug 49195 or PL-259		13/16 dia	0.06
*1	Plug (2 contacts) PL-147, PL-147A, 6578 or 9127		1-7/32 dia	0.12

1.4 AN/ARR-2X: 2

**RADIO RECEIVING EQUIPMENT AN/ARR-2X**

QTY	ITEM	STOCK NUMBERS	DIMENSIONS (INCHES)	WEIGHT (LBS)
*2	Plug (8 contacts) PL-152, PL-152A, 6577 or 9125		1-7/32 dia	0.12
1	Right Angle Coaxial Adapter 49192 or M-359		13/16 dia	0.1
1	Right Angle Adapter for Mechanical Linkage MX-22/ARR-2, MC-211-A		5/8 x 1-11/32 x 1-19/32	0.2
1	Concentric Transmission Line RG-8/U		0.41 dia x 15 ft	1.65
1	Mechanical Linkage 6151 or Tuning Shaft MC-215 (com- plete w/end fittings)		5/8 dia	
*1	Cable (4 conductors) WF-1/U		1/2 dia x 5 ft	0.75
*1	Cable (8 conductors) WM-1/U		1/2 dia x 10 ft	1.70
3	Decode Cards			

\* Furnished as required for open wire installation or by cables.

**REFERENCE DATA AND LITERATURE:**

AN16-30ARR2-2: Handbook Maintenance Instructions Aircraft Radio Receiving Equipment AN/ARR-2,  
AN/ARR-2A, AN/ARR-2X, AN/ARR-2AX.

**TUBE, CRYSTAL AND/OR SEMI-CONDUCTOR DATA:**

TUBES: (1) 12A6 (7) 9001 (3) 6AK5

CRYSTALS: Not required.

SEMI-CONDUCTORS: Not required.

**SHIPPING DATA**

PKGS	VOLUME (CU FT)	WEIGHT (LBS)
------	----------------	--------------

**PROCUREMENT DATA**

PROCURING SERVICE: USN  
SPEC &/OR DWG:

DESIGN COG: USN, BuWeps

<b>CONTRACTOR</b>	<b>LOCATION</b>	<b>CONTRACT OR ORDER NO.</b>	<b>APPROX. UNIT COST</b>
Western Electric Co., Inc.	New York, New York	NXs 4967	

20 April 1965

Cog Service: USN FSM:

RECEIVING SET RADIO AN/ARW-59

Functional Class:

USA

USN

USAF

TYPE CLASS:

Used by

MANUFACTURER'S NAME/CODE NUMBER: Collins Radio Company, (13499).

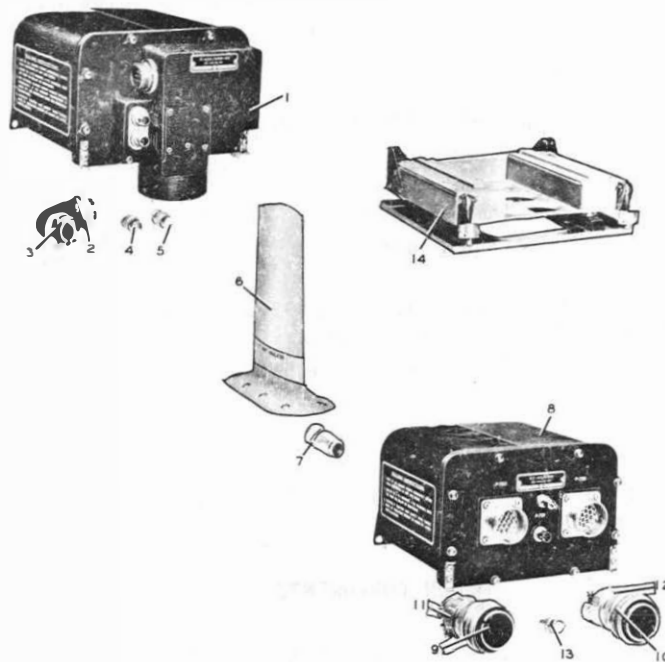

RECEIVING SET RADIO AN/ARW-59

**FUNCTIONAL DESCRIPTION:**

Receiving Set Radio AN/ARW-59 constitutes the receiving end of a radio remote control system intended primarily for the control of pilotless aircraft. The radio control signals are caused to operate relays in Audio Decoder KY-55/ARW which, in turn, operate servo-mechanisms to activate various flight control functions. The servo-mechanisms which transform the electrical control provided by this equipment into mechanical movements of the control surfaces are not part of this equipment.

No field changes in effect at time of preparation (12 April 1965).

**RELATION TO OTHER EQUIPMENT:** None.

**EQUIPMENT REQUIRED BUT NOT SUPPLIED:**

(1) Adapter UG-201/U; (1) Connector UG-88/U; (1) Power Source (Source of 27.5 v dc for equipment).

**RECEIVING SET RADIO AN/ARW-59**

**TECHNICAL CHARACTERISTICS:**

FREQUENCY COVERAGE: 406 to 420 mc on a 1 mc channel separation basis.  
 FREQUENCY CHANNELS: 15 channels; one at ea integral mc freq.  
 CHANNEL SWITCHING: Manual; cabinet must be removed to switch channels.  
 OPERATING TEMPERATURE RANGE: - 65° C (- 85° F) to 70° C (158° F).  
 ACCELERATION LIMIT: 50 g developed at a constant rate in 0.1 sec and sustained for 11 ± 1 ms.  
 CABINET PRESSURIZED FOR: 75,000 ft.  
 TYPE OF RECEPTION: Frequency Modulation (FM).  
 SELECTIVITY: 670 ± 65 kc at 6 db down, 2.2 mc or less at 60 db down.  
 SENSITIVITY: 5 uv or less input for 6 db signal plus noise to noise ratio (modulated signal plus noise to unmodulated signal plus noise ratio).  
 SPURIOUS RESPONSE: All spurious response down 60 db or more except for three which are down 50 db or more.  
 FREQUENCY STABILITY: Radio Receiver R-425/ARW-59 ± 0.01%, Audio Decoder KY-55/ARW filter circuits ± 1%.  
 INPUT IMPEDANCE  
 RADIO RECEIVER R-425/ARW-59: 50 ohms unbalanced.  
 AUDIO DECODER KY-55/ARW: 560 ohms unbalanced.  
 POWER REQUIREMENTS: 27.5 v dc.  
 FILAMENT, RADIO RECEIVER R-425/ARW-59: 1.2 amp, 33.0 w.  
 FILAMENT, AUDIO DECODER KY-55/ARW: 6 amp, 18.2 w.  
 DYNAMOTOR PLATE SUPPLY, RADIO RECEIVER R-425/ARW-59: 2.3 amp, 63.3 w.  
 DYNAMOTOR DATA  
 INPUT: 27.5 v dc at 2.3 amp.  
 OUTPUT: 128 v dc at 205 ma.  
 OPERATING TEMPERATURE RANGE: - 65° C (- 85° F) to 105° C (221° F).  
 TYPE OF INSTALLATION: Aircraft.

**MAJOR COMPONENTS**

QTY	ITEM	STOCK NUMBERS	DIMENSIONS (INCHES)	WEIGHT (LBS)
1	Receiving Set Radio AN/ARW-59 includes:			
1	Radio Receiver R-425/ARW-59, R-425A/ARW-59, or R-425B/ARW-59 includes:		6-1/8 x 7-5/16 x 8-5/8	11.5
1	Connector AN3108B-16S-1S		1-1/2 dia	0.106
2	Connector UG-88/U		9/16 dia x 1-1/32	0.03
1	Cable Clamp AN3057-8			
1	Antenna AT-335/ARW includes:		3 x 7-3/32 x 8-3/4	1.94
1	Connector UG-21B/U		25/32 dia x 1-13/16	0.10
1	Audio Decoder KY-55/ARW includes:		4-7/8 x 7-5/16 x 8-1/4	10.2
1	Connector AN3106A-22-14S		1-9/32 dia x 2-3/16	0.16
1	Connector AN3106A-22-14SW		1-9/32 dia x 2-3/16	0.16
1	Connector UG-88/U		9/16 dia x 1-1/32	0.03
2	Cable Clamp AN3057-12			
2	Mounting MT-950/ARW		2-5/8 x 8 x 8-5/8	2.3

1.4 AN/ARW-59: 2

---

RECEIVING SET RADIO AN/ARW-59

---

**REFERENCE DATA AND LITERATURE:**

NAVWEPS 16-30ARW59-1: Handbook of Operation Instructions for Radio Receiving Set AN/ARW-59.  
TO 12R3-2ARW59-1: Handbook of Operation Instructions for Radio Receiving Set AN/ARW-59.

**TUBE, CRYSTAL AND/OR SEMI-CONDUCTOR DATA:**

TUBES: (1) 5639 (2) 5647 (5) 5702WA (17) 5718 (8) 5840 (1) 5902

CRYSTALS: (16) CR-23

SEMI-CONDUCTORS: Not required.

**SHIPPING DATA**

PKGS VOLUME (CU FT) WEIGHT (LBS)

**PROCUREMENT DATA**

PROCURING SERVICE: USN  
SPEC &/OR DWG: MIL-R-7924

DESIGN COG: USN, BuWeps

CONTRACTOR	LOCATION	CONTRACT OR ORDER NO.	APPROX. UNIT COST
Collins Radio Company	Cedar Rapids, Iowa	NOa(s) 51-1183	

101



21 July 1967  
Cog Service: USN

FSN:

INERTIAL NAVIGATION SYSTEM AN/ASN-36  
Functional Class:

USA

USN

USAF

TYPE CLASS:

Used by

MANUFACTURER'S NAME/CODE NUMBER: Litton Systems Inc. Guidance and Control Systems Div.  
(06481).

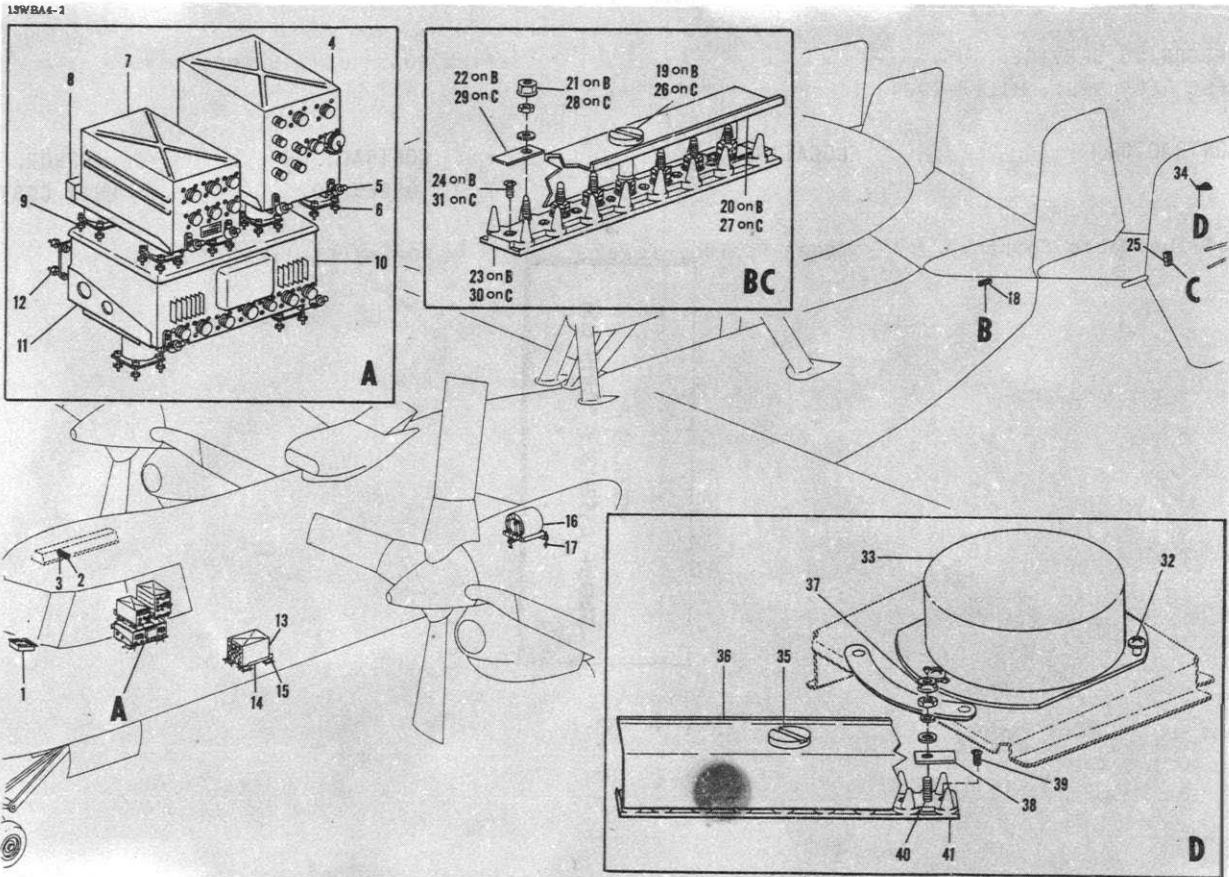

INERTIAL NAVIGATION SYSTEM AN/ASN-36

1.3 AN/ASN-36: 1



26 July 1967  
Cog Service:

USN FSN:

ANTENNA TUNING GROUP AN/BRA-6A  
Functional Class:

USA

USN

USAF

**TYPE CLASS:** Used by

**MANUFACTURER'S NAME/CODE NUMBER:** Futuronics Corporation, (14681).

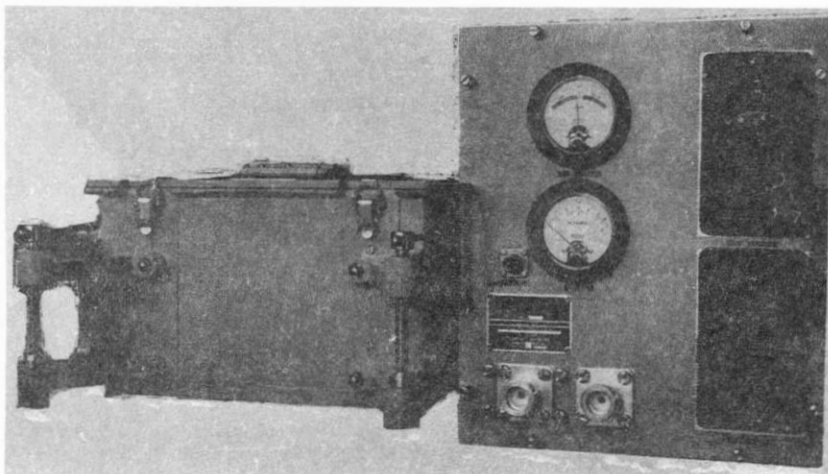

ANTENNA TUNING GROUP AN/BRA-6A

104

**FUNCTIONAL DESCRIPTION:**

The Antenna Tuning Group, AN/BRA-6A, provides for emergency communication for submarines when normally used antenna equipment is inoperable. Designed for surface operation only.

No field changes in effect at time of preparation (5 January 1967).

**RELATION TO OTHER EQUIPMENT:**

The Antenna Tuning Group AN/BRA-6A is Two-way interchangeable, except by maintenance parts, with AN/BRA-6.

**EQUIPMENT REQUIRED BUT NOT SUPPLIED:**

- (1) Antenna: AT-774A/UR;
- (1) RF Cable: RG-17/U or RG-218/U (length as required);
- (1) Stuffing Tube;
- (2) End Seal: MX-1203F/U;

1.2 AN/BRA-6A: 1

## ANTENNA TUNING GROUP AN/BRA-6A

- (3) Dummy Load: DA-91/U;
- (2) Tee Connector: UG-566A/U;
- (3) Connector: UG-573A/U; as required Cable: RC-9/U;
- (1) Potentiometer: Allen-Bradley Type- CU-2541; (250 K ohm, 2 watt).

### TECHNICAL CHARACTERISTICS:

FREQUENCY RANGE: Tunable from 2 to 30 mc (manually).

#### POWER RATING:

- (1) Average power input up to 750 watts, continuous wave (CW).
- (2) Carrier: 500 watts, amplitude modulated up to 100%.
- (3) CW Pulsed: 5000 watts; duration of pulse.
- (4) Pulse Data:
  - Duration: 3 seconds.
  - Pulse-Repetition Rate: 1 pulse every 3 minutes, maximum.

INPUT IMPEDANCE: 50 ohms at SWR of 3 to 1.

OUTPUT IMPEDANCE: 50 ohms at SWR of 3 to 1.

OUTPUT LOAD: Antenna AT-774A/UP or any antenna corrected for emergency operation at 2 to 30 mc through a 50 ohm cable, 25 to 100 feet long.

#### EFFICIENCY:

- At 2 mc, 2%.
- At 6 mc, 30%.
- At 6 to 30 mc, 30 to 80%.

INTERLOCK INPUT RATING: 10 amperes at 125 to 250 volts ac.

#### SWR METER:

- Range: 100-to-0-to 100 ma, nonlinear.
- Accuracy:  $\pm 2\%$ .

#### RF OUTPUT METER:

- Range: 0 to 100 ma, nonlinear.
- Accuracy:  $\pm 2\%$ .

#### WHERE AND HOW INSTALLED:

- RF Tuner: Bolted to table top, bulkhead, or rack mounted.
- RF COIL: Clamp mounted to any topside edge convenient to antenna.

### MAJOR COMPONENTS

QTY	ITEM	DIMENSIONS (INCHES)	WEIGHT (LBS)
1	Antenna Tuning Group; AN/BRA-6A includes:		
1	Radio Frequency Tuner: TN-439/BRA-6A	12-1/2 x 15-5/8 x 16-7/8	73
1	Radio Frequency Coil: RF-91A/BRT	9-1/16 x 10-1/4 x 14-7/8	33
1	Connector Plug: UG-154/U		
2	Connector Plug: UG-154A/U		
1	Connector Plug: MS3106E10SL-4S		
2	Technical Manual: NavShips 94198, and NavShips: 0967-064-6011		

### REFERENCE DATA AND LITERATURE:

NAVSHIPS 94198: Technical Manual for Antenna Tuning Group AN/BRA-6 and AN/BRA-6A.

---

---

ANTENNA TUNING GROUP AN/BRA-6A

---

---

NAVSHIPS 0967-064-6011: Technical Manual for Antenna Tuning Group AN/BRA-6A, (change 1).

SHIPPING DATA

PKGS	VOLUME (CU FT)	WEIGHT (LBS)
1	4.4	100
1	2.5	55

PROCUREMENT DATA

PROCURING SERVICE: USN  
SPEC &/OR DWG: SHIPS-A-4861

DESIGN COG: USN, NavShips

CONTRACTOR	LOCATION	CONTRACT OR ORDER NO.	APPROX. UNIT COST
Futronics Corporation Part No. 211 Request No 627K1-56341	Port Washington, N.Y.	N0bsr-91241	

12 August 1965

ANTENNA GROUP AN/BRA-11

Cog Service: USN FSM:

Functional Class:

USA

USN

USAF

TYPE CLASS:

Used by

MANUFACTURER'S NAME/CODE NUMBER: ITT Federal Lab Div. of International Telephone and Telegraph Corporation, (90348).



ANTENNA GROUP AN/BRA-11

#### FUNCTIONAL DESCRIPTION:

Antenna Group AN/BRA-11 provides a medium frequency/high frequency antenna system for submarine communications. The antenna group accomplishes this function by accepting RF signals generated by a transmitter aboard the submarine, providing the proper impedance match between a 50 ohm transmission line and the radiating element, and radiating the RF signals to distant stations. In addition, the antenna group contains facilities for tuning its radiating element to any frequency between 2 and 32 megacycles and for providing indications of incident power and standing wave ratio on the transmission line.

No field changes in effect at time of preparation (22 July 1965).

#### RELATION TO OTHER EQUIPMENT:

The AN/BRA-11 and the AN/BRA-11(XN-1) are similar in operation, radiating, and power handling capabilities, but are not interchangeable since installation, operation and maintenance are dissimilar.

---

**ANTENNA GROUP AN/BRA-11**

---

**EQUIPMENT REQUIRED BUT NOT SUPPLIED:** None.

**TECHNICAL CHARACTERISTICS:**

FREQUENCY RANGE: 2 to 32 mc.

TYPE OF FREQUENCY CONTROL: Manually-controlled tuning.

STANDING WAVE RATIO: Less than 4 to 1 on a 50 ohm feedline.

INPUT RF POWER HANDLING CAPABILITIES: 500 W continuously or up to 1000 W at 100% duty cycle for 5 min.

POWER REQUIREMENTS: 115 v, 60 cps, 1 ph, 20 amp.

**MAJOR COMPONENTS**

QTY	ITEM	DIMENSIONS (INCHES)	WEIGHT (LBS)
1	Antenna Group AN/BRA-11 includes:		
1	Antenna AS-1646/BRA-11	6-5/8 dia x 194	400
1	Antenna Control C-6249/BRA-11	9-39/64 x 12-5/8 x 13-1/4	40
1	Control Cable Kit MK-777/BRA-11		
1	Radio Frequency Cable Kit MK-778/BRA-11		
2	Technical Manual NAVSHIPS 95760		

108

**REFERENCE DATA AND LITERATURE:**

NAVSHIPS 95768: Technical Manual for Antenna Group AN/BRA-11.

**TUBE, CRYSTAL AND/OR SEMI-CONDUCTOR DATA:**

TUBES: Not required.

CRYSTALS: Not required.

SEMI-CONDUCTORS: (4) 1N540M (1) 1N746AM (1) 1N2997B (4) 1N277M

**SHIPPING DATA**

PKGS	VOLUME (CU FT)	WEIGHT (LBS)
------	----------------	--------------

**PROCUREMENT DATA**

PROCURING SERVICE: USN

DESIGN COG: USN, BuShips

SPEC &/OR DWG:

1.1 AN/BRA-11: 2

---

ANTENNA GROUP AN/BRA-11

---

CONTRACTOR	LOCATION	CONTRACT OR ORDER NO.	APPROX. UNIT COST
ITT Federal Lab Div. of International Telephone and Telegraph Corp.	Nutley, New Jersey	N0bsr 89529	

109



4 April 1966

ANTENNA GROUP AN/BRA-11(XN-1)

Cog Service: USN FSN:

Functional Class:

USA

USN

USAF

TYPE CLASS:

Used by

MANUFACTURER'S NAME/CODE NUMBER: ITT Federal Laboratories A Division of International Telephone and Telegraph, Corporation, (90348).

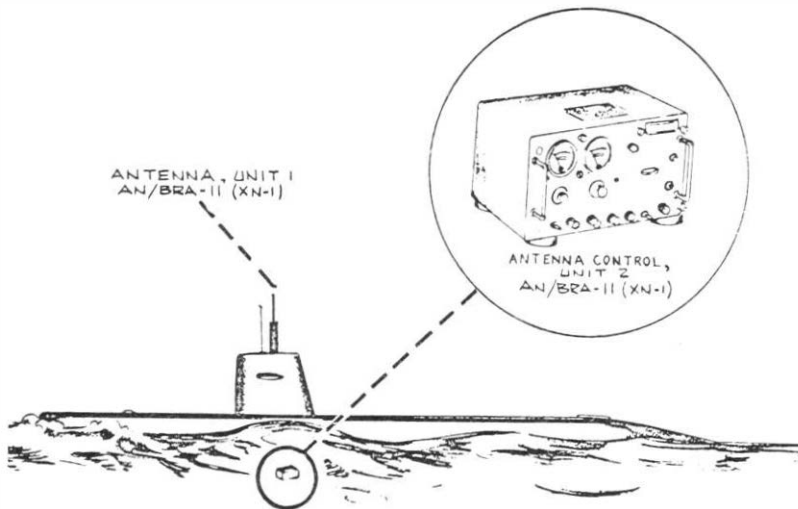

ANTENNA GROUP AN/BRA-11(XN-1)

110

**FUNCTIONAL DESCRIPTION:**

The Antenna Group AN/BRA-11(XN-1) provides a medium frequency/high frequency antenna system for submarine communications. Is designed to operate over a frequency range of 2 to 32 mc at 500 watts continuous power for period of 1/2 hour maximum, with the capability of handling 1000 watts continuous power for 5 minutes.

No field changes in effect at time of preparation (15 December 1965).

**RELATION TO OTHER EQUIPMENT:** None.

**EQUIPMENT REQUIRED BUT NOT SUPPLIED:**

(1) Transmitter or Receiver; (1) Bulk Cable RG-218/U.

1.1 AN/BRA-11(XN-1): 1

**ANTENNA GROUP AN/BRA-11(XN-1)**

**TECHNICAL CHARACTERISTICS:**

FREQUENCY RANGE: 2 to 32 mc.

STANDING WAVE RATIO: Less than 4 to 1 on a 50 ohm feedline.

RF POWER INPUT: 500 watts, continuous for 1/2 hour; 1000 watts continuous for 5 minute periods, 50% duty cycle 1/2 hour maximum total.

**MAJOR COMPONENTS**

QTY	ITEM	STOCK NUMBERS	DIMENSIONS (INCHES)	WEIGHT (LBS)
1	Antenna Group AN/BRA-11(XN-1) includes:		6-3/8 dia x 192-11/64	360
1	Antenna Control		9-1/2 x 14-1/2 x 17-1/2	55
1	Control Cable			18
1	RF Cable			
1	Connector Plug UG-154/U			

**REFERENCE DATA AND LITERATURE:**

NAVSHIPS 95946: Technical Manual for Antenna Group AN/BRA-11(XN-1).

**TUBE, CRYSTAL AND/OR SEMI-CONDUCTOR DATA:**

TUBES: (2) 6RS21SA7D7

CRYSTALS: Not required.

SEMI-CONDUCTORS: (13) 1N270 (3) 1N540 (4) 1N134E (2) 5V3140 (1) 2N325 (9) 2N388  
(1) 2N489 (2) 2N11776

**SHIPPING DATA**

PKGS VOLUME (CU FT) WEIGHT(LBS)

**PROCUREMENT DATA**

PROCURING SERVICE: USN  
SPEC &/OR DWG:

DESIGN COG: USN, BuShips

CONTRACTOR	LOCATION	CONTRACT OR ORDER NO.	APPROX. UNIT COST
ITT Federal Laboratories A Division of International Telephone and Telegraph, Corporation	Nutley, N. J.	NObsr 81568	

9 September 1965

ANTENNA TUNING GROUP AN/BRA-13A

Cog Service: USN FSM:

Functional Class:

USA

USN

USAF

TYPE CLASS:

Used by

MANUFACTURER'S NAME/CODE NUMBER: Granite State Machine Co. Inc., (82005).

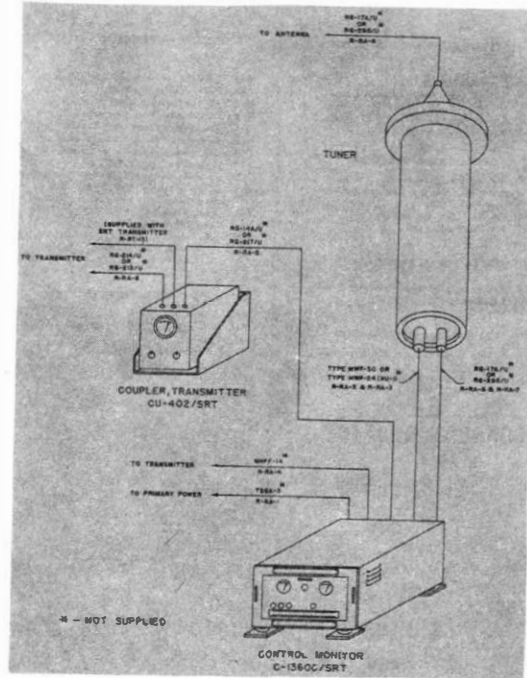

ANTENNA TUNING GROUP AN/BRA-13A

FUNCTIONAL DESCRIPTION:

Antenna Tuning Group AN/BRA-13A provides a means for tuning and matching an antenna to its associated transmitter. Tuning is accomplished by matching the transmitter to the transmission line, and matching the antenna to the transmission line. To do this, portions of the Antenna Tuning Group automatically tune and match the antenna impedance to the characteristic impedance of the transmission line throughout the frequency range of its associated transmitter. This is done by inserting or removing inductance in the antenna circuit, thus increasing or decreasing the effective length of the antenna. At the same time, another portion of the Antenna Tuning Group provides the means for matching the transmitter output impedance to the characteristic impedance of the transmission line, thereby providing maximum transfer of power from the transmitter to the transmission line. Remote manual tuning can also be performed by an operator, by use of controls provided on the Control-Monitor portion of the equipment.

Antenna Tuning Group AN/BRA-13A is designed to operate with Radio Transmitting Sets AN/WRT-2; AN/URT-2, -3, and -4 series; TBK-13, -18, -19 and -20 series; TBL-4 thru 9, -12, and

---

**ANTENNA TUNING GROUP AN/BRA-13A**

---

13 series; TBM-5, -7, -9, and -11; TDE-1, -2, and -3; AN/SRT-14, -15 and -16; AN/URC-32; and Navy Type Whip Antenna 56053, or Standard Split-Whip Antenna AT-350.

No field changes in effect at time of preparation (20 August 1965).

**RELATION TO OTHER EQUIPMENT:**

Similar to AN/BRA-13 and AN/BRA-17 except for different Radio Frequency Tuners.

**EQUIPMENT REQUIRED BUT NOT SUPPLIED:** None.

**TECHNICAL CHARACTERISTICS:**

FREQUENCY RANGE: 2 to 30 mc.

IMPEDANCE: 50 ohms.

VSWR: 4:1 max.

MAXIMUM RF POWER INPUT: 1000 W peak envelope power.

INSERTION LOSS: 0.5 db max.

PRESSURIZATION: TN-375A/BRA-13 pressurized internally with nitrogen to 25 psi.

**HEAT DISSIPATION**

RADIO FREQUENCY TUNER: 60 W max.

TRANSMITTER COUPLER: 0 W.

CONTROL-MONITOR: 150 W max.

POWER REQUIREMENTS: 120 v, 60 cps, 1 ph.

**MAJOR COMPONENTS**

QTY	ITEM	DIMENSIONS (INCHES)	WEIGHT (LBS)
1	Antenna Tuning Group AN/BRA-13A includes:		
1	Radio Frequency Tuner TN-375A/BRA-13	12-1/8 x 12-1/8 x 61-3/4	255
1	Control-Monitor C-1360C/SRT	11-3/8 x 17-5/8 x 18-11/16	74
1	Transmitter Coupler CU-402/SRT	7-11/16 x 9-5/32 x 9-7/16	11
1	Installation Kit		
2	Technical Manuals NAVSHIPS 94399		
1	Accessory Bag		

**REFERENCE DATA AND LITERATURE:**

NAVSHIPS 94399: Technical Manual for Antenna Tuning Groups AN/BRA-13, AN/BRA-13A, AN/BRA-17.

**TUBE, CRYSTAL AND/OR SEMI-CONDUCTOR DATA:**

TUBES: (2) 12AT7WA (1) 5726/6AL5 (1) 5727/2D21 (1) 5670 (1) 0A2WA (1) 0B2WA

CRYSTALS: Not required.

---

ANTENNA TUNING GROUP AN/BRA-13A

---

SEMI-CONDUCTORS: (2) 1N39 (2) 1N68

SHIPPING DATA

PKGS	VOLUME (CU FT)	WEIGHT (LBS)
1	12.83	350
1	4.2	125
1	1.35	27

PROCUREMENT DATA

PROCURING SERVICE: USN  
SPEC &/OR DWG: MIL-A-22828

DESIGN COG: USN, BuShips

CONTRACTOR	LOCATION	CONTRACT OR ORDER NO.	APPROX. UNIT COST
Granite State Machine Co., Inc.	Manchester, New Hampshire	N0bsr 75869 N0bsr 85485 N0bsr 85493	\$2200.00

10 September 1965  
 Cog Service: USN FSN:

ANTENNA GROUP AN/BRA-14  
 Functional Class:

USA

USN

USAF

TYPE CLASS:

Used by

MANUFACTURER'S NAME/CODE NUMBER: Chu Associates, (04953).

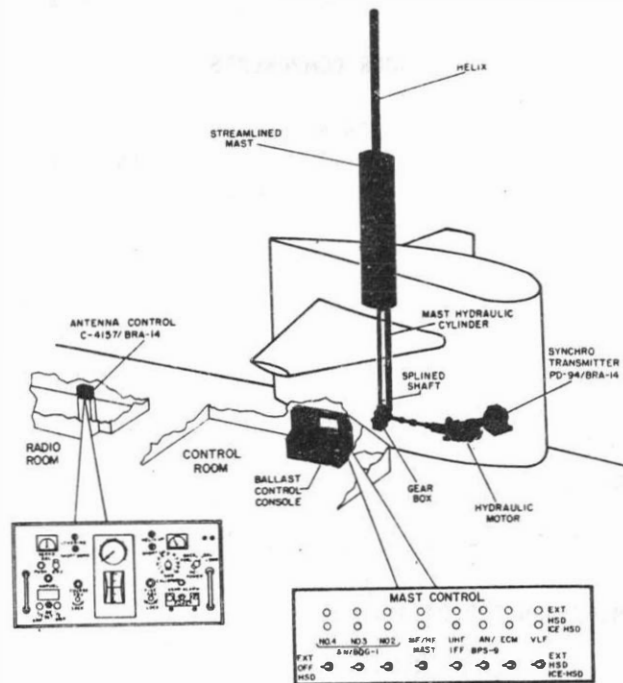

ANTENNA GROUP AN/BRA-14

**FUNCTIONAL DESCRIPTION:**

Antenna Group AN/BRA-14 is designed for installation aboard submarines to provide a reliable transmitting and receiving antenna in the 2 to 32 megacycle frequency range. The system consists of a helix approximately ten feet long, grounded at its base to the submarine and wound in such a manner that the turns density varies linearly along its axis. A three turn coupling coil fits inside the helix and couples energy to the helix. A shorting tube which is used to capacitively short the lower portions of the helix, reduces the inductance in the helix and tunes it to resonance.

The coupling loop is attached to the top of the shorting tube at a fixed distance and moves with the shorting tube inside the helix, the helix being embedded in fiberglass. With the exception of the coupling coil which is housed within a fiberglass capsule, the system is designed to be free-flooding. It is designed to be used with a retractable, streamlined mast.

No field changes in effect at time of preparation (23 August 1965).

---

**ANTENNA GROUP AN/BRA-14**

---

**RELATION TO OTHER EQUIPMENT:** None.

**EQUIPMENT REQUIRED BUT NOT SUPPLIED:**

(1) Streamline Mast.

**TECHNICAL CHARACTERISTICS:**

**FREQUENCY RANGE:** 2 to 32 mc.

**POWER REQUIREMENTS:** The Antenna Control requires three separate sources of 115 v, 60 cps, 1 ph power; 250 W for indicating circuit and 30 W for servo power.

**MAJOR COMPONENTS**

QTY	ITEM	STOCK NUMBERS	DIMENSIONS (INCHES)	WEIGHT (LBS)
1	Antenna Group AN/BRA-14 includes:			
1	Antenna AS-1294/BRA-14			
1	Antenna Control C-4157/BRA-14			
1	Synchro Transmitter PD-94/BRA-14			

116

**REFERENCE DATA AND LITERATURE:**

Preliminary Instruction Book for AN/BRA-14 Antenna Group.

**TUBE, CRYSTAL AND/OR SEMI-CONDUCTOR DATA:**

**TUBES:** (1) 5751WA (2) 6BQ7A (1) 0B2WA

**CRYSTALS:** Not required.

**SEMI-CONDUCTORS:** (6) 1N538 (4) 1N540 (4) 1N645 (1) 1N708 (1) 1N1822A (2) SG-22  
(7) 2N334 (2) 2N497

**SHIPPING DATA**

PKGS	VOLUME (CU FT)	WEIGHT (LBS)
------	----------------	--------------

**PROCUREMENT DATA**

**PROCURING SERVICE:** USN

**DESIGN COG:** USN, BuShips

**SPEC &/OR DWG:**

1.1 AN/BRA-14: 2

---

ANTENNA GROUP AN/BRA-14

---

CONTRACTOR	LOCATION	CONTRACT OR ORDER NO.	APPROX. UNIT COST
Chu Associates	Littleton, Massachusetts	N0bs 79311(x)	



19 September 1965

Cog Service: USN FSN:

ANTENNA TUNING GROUP AN/BRA-17

Functional Class:

USA

USN

USAF

TYPE CLASS:

Used by

MANUFACTURER'S NAME/CODE NUMBER: Granite State Machine Co., Inc., (82005).

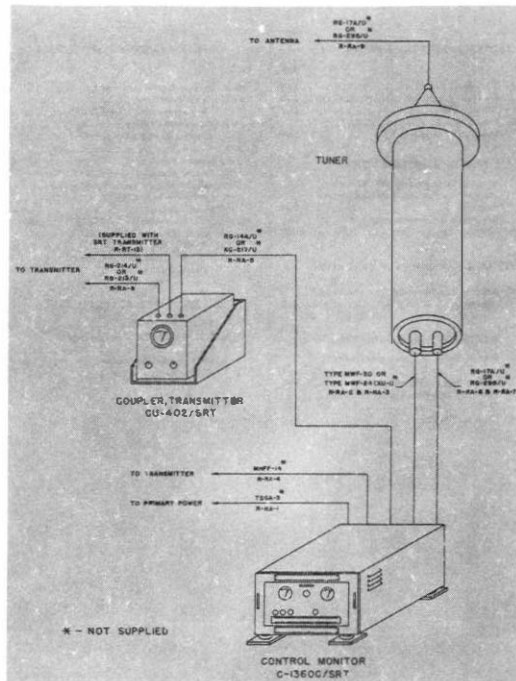

ANTENNA TUNING GROUP AN/BRA-17

### FUNCTIONAL DESCRIPTION:

Antenna Tuning Group AN/BRA-17 provides a means for tuning and matching an antenna to its associated transmitter. Tuning is accomplished by matching the transmitter to the transmission line, and matching the antenna to the transmission line. To do this, portions of the Antenna Tuning Group automatically tune and match the antenna impedance to the characteristic impedance of the transmission line throughout the frequency range of its associated transmitter. This is done by inserting or removing inductance in the antenna circuit, thus increasing or decreasing the effective length of the antenna. At the same time another portion of the Antenna Tuning Group provides the means for matching the transmitter output impedance to the characteristic impedance of the transmission line, thereby providing maximum transfer of power from the transmitter to the transmission line. Remote manual tuning can also be performed by an operator, by use of controls provided on the Control-Monitor portion of the equipment.

---

## ANTENNA TUNING GROUP AN/BRA-17

---

Antenna Tuning Group AN/BRA-17 is designed to operate with Radio Transmitting Sets AN/WRT-2; AN/URT-2, -3, and -4 series; TBK-13, -18, -19, and -20 series; TBL-4 thru 9, -12, and -13 series; TBM-5, -7, -9, and -11; TDE-1, -2, and -3; AN/SRT-14, -15, and -16; AN/URC-32; and Navy Type Whip Antenna 66053, or standard split-whip Antenna AT-350.

No field changes in effect at time of preparation (20 August 1965).

### RELATION TO OTHER EQUIPMENT:

Similar to AN/BRA-13 and AN/BRA-13A except for different Radio Frequency Tuners.

**EQUIPMENT REQUIRED BUT NOT SUPPLIED:** None.

### TECHNICAL CHARACTERISTICS:

FREQUENCY RANGE: 2 to 30 mc.

IMPEDANCE: 50 ohms.

VSWR: 4:1 max.

MAXIMUM RF POWER INPUT: 1000 W peak envelope power.

INSERTION LOSS: 0.5 db max.

PRESSURIZATION: TN-395/BRA-17 pressurized internally with nitrogen to 25 psi.

#### HEAT DISSIPATION

RADIO FREQUENCY TUNER: 60 W max.

TRANSMITTER COUPLER: ~~4~~ W.

CONTROL-MONITOR: 150 W max.

POWER REQUIREMENTS: 120 v, 60 cps, 1 ph.

### MAJOR COMPONENTS

QTY	ITEM	DIMENSIONS (INCHES)	WEIGHT (LBS)
1	Antenna Tuning Group AN/BRA-17 includes:		
1	Radio Frequency Tuner TN-395/BRA-17	12-1/8 x 12-1/8 x 61-3/4	255
1	Control-Monitor C-1360C/SRT	11-3/8 x 17-5/8 x 18-11/16	74
1	Transmitter Coupler CU-402/SRT	7-11/16 x 9-5/32 x 9-7/16	11
1	Installation Kit		
2	Technical Manuals NAVSHIPS 94399		
1	Accessory Bag		

### REFERENCE DATA AND LITERATURE:

NAVSHIPS 94399: Technical Manual for Antenna Tuning Groups AN/BRA-13, AN/BRA-13A, AN/BRA-17.

---

**ANTENNA TUNING GROUP AN/BRA-17**

---

**TUBE, CRYSTAL AND/OR SEMI-CONDUCTOR DATA:**

TUBES: (2) 12AT7WA (1) 5726/6AL5 (1) 5727/2D21 (1) 5670 (1) 0A2WA (1) 0B2WA

CRYSTALS: Not required.

SEMI-CONDUCTORS: (2) 1N39 (2) 1N68

**SHIPPING DATA**

PKGS	VOLUME (CU FT)	WEIGHT (LBS)
1	12.83	350
1	4.2	125
1	1.35	27

**PROCUREMENT DATA**

PROCURING SERVICE: USN  
SPEC &/OR DWG: MIL-A-22828

DESIGN COG: USN, BuShips

CONTRACTOR	LOCATION	CONTRACT OR ORDER NO.	APPROX. UNIT COST
Granite State Machine Co., Inc.	Manchester, New Hampshire	NObsr 85493	\$4651.00

120

28 July 1964

Cog Service: USN FSN: 2F5985-981-3247

ANTENNA TRANSFER ASSEMBLY AN/BRA-18

Functional Class:

USA

USN

USAF

TYPE CLASS:

Used by

MANUFACTURER'S NAME/CODE NUMBER: Bowen Tools Incorporated, (14820).

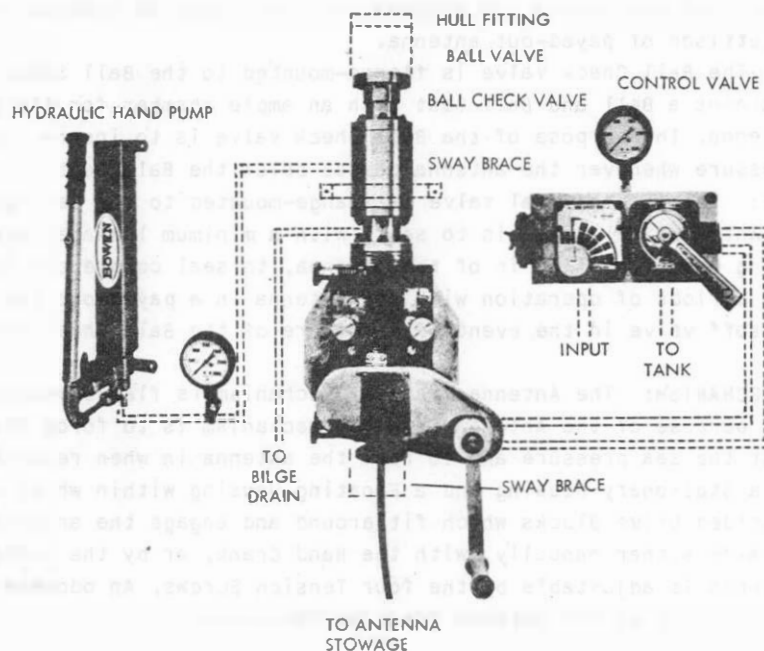

ANTENNA TRANSFER ASSEMBLY AN/BRA-18

**FUNCTIONAL DESCRIPTION:**

Antenna Transfer Assembly AN/BRA-18 is a mechanism designed to permit the "paying-out" or "paying-in" of a buoyant antenna from a submarine hull against sea pressure without leakage of seawater into the hull. In addition to the hydraulic-mechanical transfer of the antenna in either direction the Antenna Transfer Assembly provides sealing of the buoyant antenna against the entry of sea water and safety devices to completely shut off sea pressure when ever it may become necessary to cut off the antenna or when the antenna is completely brought into the hull.

No field changes in effect at time of preparation (15 May 1964).

**RELATION TO OTHER EQUIPMENT:**

## AN/BRA-18 ANTENNA TRANSFER ASSEMBLY

### EQUIPMENT REQUIRED BUT NOT SUPPLIED:

### TECHNICAL CHARACTERISTICS:

**BALL SHEAR VALVE:** This equipment, while not furnished by the contractor, is an integral part of the system. This equipment is mounted to the hull at the base of the Antenna Conduit. It is a three position valve that provides a shutoff when the equipment is not in use, an open position for paying the antenna in or out, and an antenna shear position for the emergency jettison of payed-out antenna.

**BALL CHECK VALVE:** The Ball Check Valve is flange-mounted to the Ball Shear Valve. The Ball Check Valve contains a Ball and Ball Seat with an ample chamber for the Ball to lay alongside of the antenna. The purpose of the Ball Check Valve is to insure immediate closure against sea pressure whenever the antenna passes below the Ball Seat.

**ANTENNA SEAL VALVE:** The Antenna Seal Valve is flange-mounted to the Ball Check Valve. The purpose of the Antenna Seal Valve is to seal, with a minimum leakage, against sea pressure during the paying out or reeling in of the antenna, to seal completely around the antenna during extended periods of operation with the antenna in a payed-out position and finally to act as a shutoff valve in the event of a failure of the Ball Shear Valve and the Ball Check Valve.

**ANTENNA TRANSFER MECHANISM:** The Antenna Transfer Mechanism is flange-mounted to the Antenna Seal Valve. The purpose of the Antenna Transfer Mechanism is to force the antenna out of the hull against the sea pressure and to reel the antenna in when required. It consists essentially of a Stationary Housing and a Floating Housing within which are drive chains equipped with molded Drive Blocks which fit around and engage the antenna. Power is applied to the drive chains either manually, with the Hand Crank, or by the Hydraulic Motor. Pressure on the antenna is adjustable by the four Tension Screws. An odometer (footage counter) is mounted on the front of the Antenna Transfer Mechanism.

### CONTROL EQUIPMENT

**HYDRAULIC HAND PUMP:** The Hydraulic Hand Pump is connected to the Antenna Seal Valve and is used to apply hydraulic pressure to the Piston in the Antenna Seal Valve in order to tighten the Seal Valve Rubbers.

**CONTROL VALVE:** The Control Valve is connected to the Hydraulic Motor of the Antenna Transfer Mechanism and is used to control the speed and direction of the drive chains.

### MAJOR COMPONENTS

QTY	ITEM	STOCK NUMBERS	DIMENSIONS (INCHES)	WEIGHT (LBS)
1	Antenna Transfer Assembly AN/BRA-18 includes:			
1	Ball Check Valve Assembly MX-4626/BRA-18			20
1	Antenna Seal Valve MX-4629/BRA-18 includes:			55
1	Antenna Transfer Mechanism			113
1	Pump, Hydraulic, Hand Driven MX-4628/BRA-18		5-1/4 x 7-3/4 x 16-3/4	30

1.2 AN/BRA-18: 2

---

**ANTENNA TRANSFER ASSEMBLY AN/BRA-18**

---

QTY	ITEM	STOCK NUMBERS	DIMENSIONS (INCHES)	WEIGHT (LBS)
1	Control Valve		9 x 11-1/4 x 12-1/2	42
1	Spare Parts Kit			

---

**REFERENCE DATA AND LITERATURE:**

---

NAVSHIPS 94610(A): Technical Manual for Antenna Transfer Assembly AN/BRA-18.

---

---

**TUBE, CRYSTAL AND/OR SEMI-CONDUCTOR DATA:**

TUBES: None required.

CRYSTALS: None required.

SEMI-CONDUCTORS: None required.

---

**SHIPPING DATA**

---

PKGS	VOLUME (CU FT)	WEIGHT (LBS)
------	----------------	--------------

---

---

**PROCUREMENT DATA**

---

PROCURING SERVICE: USN  
SPEC &/OR DWG:

DESIGN COG: USN, BuShips

---

CONTRACTOR	LOCATION	CONTRACT OR ORDER NO.	APPROX. UNIT COST
Bowen Tools Incorporated	Houston, Texas	NObsr 89475	\$3842.00

---

10 September 1965

Cog Service: USN FSN:

ANTENNA TRANSFER ASSEMBLY AN/BRA-18A

Functional Class:

USA

USN

USAF

TYPE CLASS:

Used by

MANUFACTURER'S NAME/CODE NUMBER: Bowen Tools Inc., (14820).

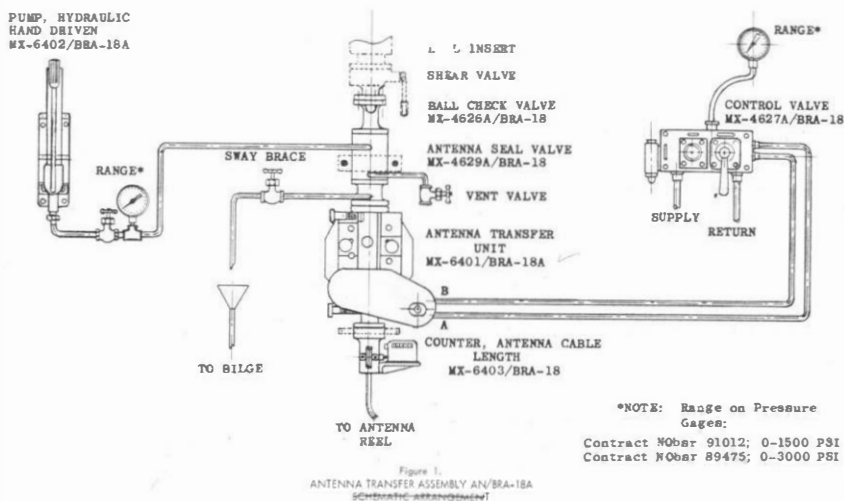

ANTENNA TRANSFER ASSEMBLY AN/BRA-18A

**FUNCTIONAL DESCRIPTION:**

Antenna transfer Assembly AN/BRA-18A is a mechanism designed to permit the "paying-out" or "paying-in" of a buoyant antenna from a submarine hull against sea pressure. Some leakage (about five gallons per hour minimum) of sea water into the hull is necessary for lubrication of the sealing rubber. In addition to the hydraulic-mechanical and manual hand crank transfer of the antenna in either direction, it also provides sealing of the buoyant antenna against the entry of sea water and utilizes safety devices to completely shut off sea pressure whenever it may become necessary to cut off the antenna and/or when the antenna is completely brought into the hull.

No field changes in effect at time of preparation (23 August 1965).

**RELATION TO OTHER EQUIPMENT:**

The AN/BRA-18A and the AN/BRA-18 are functionally interchangeable.

---

## ANTENNA TRANSFER ASSEMBLY AN/BRA-18A

---

EQUIPMENT REQUIRED BUT NOT SUPPLIED: None.

### TECHNICAL CHARACTERISTICS:

SHEAR VALVE (G.F.E.): This unit is mtd to the hull insert at the base of the antenna conduit. It is a 3-position valve that provides a shut off when the equip is not in use; an open position for paying the antenna in or out, and an antenna shear position to allow for the emergency jettison of the payed-out antenna.

BALL CHECK VALVE ASSEMBLY: Is flange mtd to the Shear Valve. Its purpose is to insure immediate closure against sea pressure, whenever the antenna passes below the ball seat.

ANTENNA SEAL VALVE: Is normally mtd to the Ball Check Valve. In some instances, there may be a spacer tube to accommodate layout restrictions. It is designed to seal, with a minimum leakage against sea pressure, during the paying-out or reeling-in of the antenna, to seal completely around the antenna during extended periods of operation with the antenna in a payed-out position and finally to act as a shut-off valve in the event of a failure of the Ball Shear Valve and Ball Check Valve.

ANTENNA TRANSFER UNIT: Is flange mtd to the Antenna Seal Valve. It is designed to pay the Antenna in or out of the hull against the seal pressure and to furnish an auxiliary seal (Fat "O" Ring) against sea pressure.

COUNTER, ANTENNA CABLE LENGTH: Is mtd below the lower flange of the Antenna Trnsfer Unit. This device is operated by the movement of the cable and can be reset to zero.

PUMP, HYDRAULIC, HAND DRIVEN: It is used to supply hydraulic pressure to the piston in the Antenna Seal Valve to compress the line rubber when desired.

CONTROL VALVE: Consists of a group of valves sub-plate mtd on a single manifold block and a pressure gauge. This valve assembly may be connected to a hydraulic system ranging from 600 psig to 3000 psig to provide control of pressure, speed and direction of hydraulic fluid to the hydraulic motor powering the Antenna Transfer Unit.

### MAJOR COMPONENTS

QTY	ITEM	DIMENSIONS (INCHES)	WEIGHT (LBS)
1	Antenna Transfer Assembly AN/BRA-18A includes:		
1	Shear Valve (G.F.E.)		
1	Ball Check Valve Assembly MX-4626A/BRA-18		
1	Antenna Seal Valve MX-4629A/BRA-18		
1	Antenna Transfer Unit MX-6401/BRA-18A		
1	Pump, Hydraulic, Hand Driven MX-6402/BRA-18A		
1	Control Valve MX-4627A/BRA-18		
1	Counter, Antenna Cable Length MX-6403/BRA-18		

### REFERENCE DATA AND LITERATURE:

NAVSHIPS 95803: Technical Manual Antenna Transfer Assembly AN/BRA-18A.



---

ANTENNA TRANSFER ASSEMBLY AN/BRA-18A

---

TUBE, CRYSTAL AND/OR SEMI-CONDUCTOR DATA:

TUBES: Not required.

CRYSTALS: Not required

SEMI-CONDUCTORS: Not required.

SHIPPING DATA

PKGS	VOLUME (CU FT)	WEIGHT (LBS)
------	----------------	--------------

LOCATION PROCUREMENT DATA

PROCURING SERVICE: USN

DESIGN COG: USN, BuShips

SPEC &/OR DWG: SHIPS-A-4443

CONTRACTOR	LOCATION	CONTRACT OR ORDER NO.	APPROX. UNIT COST
Bowen Tools Inc.	Houston, Texas	N05sr 91012 N05sr 89475	

18 September 1967  
Cog Service: USN FSN:

ANTENNA GROUP AN/BRA-19(XN-1)  
Functional Class:

USA

USN

USAF

**TYPE CLASS:**

Used by

**MANUFACTURER'S NAME/CODE NUMBER:** General Dynamics Corp., Electric Boat Div., (96169).

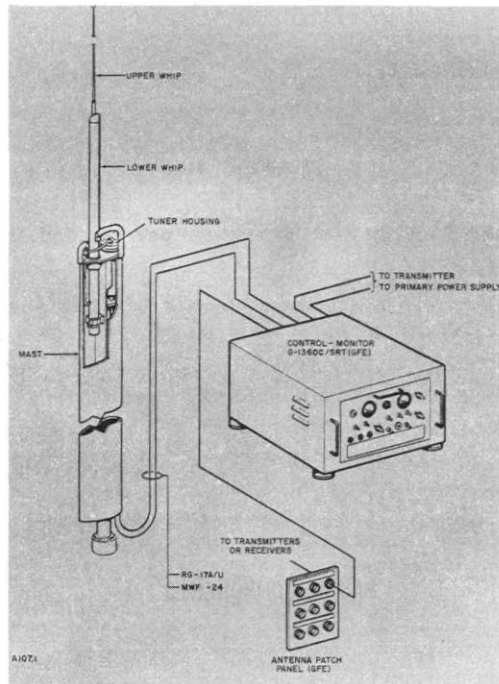

ANTENNA GROUP AN/BRA-19(XN-1)

**FUNCTIONAL DESCRIPTION:**

The Antenna Group AN/BRA-19(XN-1) is designed for use with radio transmitters operating in the frequency range from 2 to 30 mc and Antenna Tuning Group AN/BRA-13.

No field changes in effect at time of preparation (18 April 1966).

**RELATION TO OTHER EQUIPMENT:** None.

**EQUIPMENT REQUIRED BUT NOT SUPPLIED:**

(1) Antenna Tuning Group AN/BRA-13; (3) Radio Transmitting Sets, AN/URT-2, AN/URT-3, AN/AN/URT-4; (1) Technical Manual: NAVSHIPS 91833(A); (3) Radio Transmitting Sets, AN/SRT-14A, AN/SRT-15A, AN/SRT-16A; (1) Technical Manual: NAVSHIPS 92121A; (1) Technical Manual: NAVSHIPS 93319A; (1) Technical Manual: NAVSHIPS 93285A.

1.1 AN/BRA-19(XN-1): 1

---

## ANTENNA GROUP AN/BRA-19(XN-1)

---

### TECHNICAL CHARACTERISTICS:

#### FREQUENCY RANGE

TRANSMITTING: 2.0 to 30 mc.

RECEIVING: 15 kc to 30 mc.

TRANSMITTING CHARACTERISTICS: (Obtained through use of AN/BRA-13 tuner).

RADIO FREQUENCY POWER: 1000 watts, PEP (Peak effective power).

VSWR: (Voltage standing wave ratio) 4 to 1 or less.

TYPES OF TRANSMISSION AND RECEPTION: All RF signals in ranges indicated in a.

#### ANTENNA CHARACTERISTICS

EFFECTIVE LENGTH: 30 feet approximately.

WHIP LENGTH: 13 feet approximately.

PULSE CABLE LENGTH: 20 feet approximately.

FUNDAMENTAL FREQUENCY: 7.5 mc approximately.

AMBIENT TEMPERATURE LIMITS: none.

#### HYDRAULIC POWER REQUIREMENTS

INPUT PRESSURE AND FLOW RATE: 1300 psi at 9 inches per second.

OPERATING PRESSURE: 1300 psi.

TEST-PRESSURE: 1950 psi.

#### ELECTRIC POWER REQUIREMENTS

ANTENNA: none.

TUNING EQUIPMENT: 120 v ac, 60 cyc, single phase.

OPERATING DEPTH: To snorkel depth.

OPERATING SPEED: To 15 knots, submerged.

TIME TO RAISE: 30 seconds approximately.

TIME TO LOWER: 30 seconds approximately.

### MAJOR COMPONENTS

QTY	ITEM	DIMENSIONS (INCHES)	WEIGHT (LBS)
1	Antenna Group AN/BRA-19(XN-1) includes:	13 x 27 x 574	
	Upper whip	3-1/2 x 3-1/2 x 222	
	Lower Whip	5-1/2 x 5-1/2 x 276	
	Mast and Closure Cap	13 x 27 x 292	
	Tuner Housing		
	Erecting Gear		
1	Hoist Assembly includes:	10 x 10 x 426	
	Hoist Cylinder	10 x 10 x 209	
	Main Piston and Rod	3-1/2 x 3-1/2 x 226	
1	RF Tuner (GFE) TN-375A/BRA-13	12-1/8 x 12-1/8 x 66	250

### REFERENCE DATA AND LITERATURE:

NAVSHIPS 94696: Technical Manual Type 1 for Telescoping whip Antenna AN/BRA-19(XN-1).

---

ANTENNA GROUP AN/BRA-19(XN-1)

---

SHIPPING DATA

PKGS

VOLUME (CU FT)

WEIGHT (LBS)

PROCUREMENT DATA

PROCURING SERVICE: USN  
SPEC &/OR DWG:

DESIGN COG: USN, BuShips

CONTRACTOR	LOCATION	CONTRACT OR ORDER NO.	APPROX. UNIT COST
General Dynamics Corp., Electric Boat Div.	Groton, Conn.	N140(70024/140) 70741B(FBM)	

26 August 1965

Cog Service: USN FSN:

DIRECTION FINDER SET AN/BRD-5

Functional Class:

USA

USN

USAF

TYPE CLASS:

Used by

MANUFACTURER'S NAME/CODE NUMBER: Sanders Associates Incorporated, (12217).

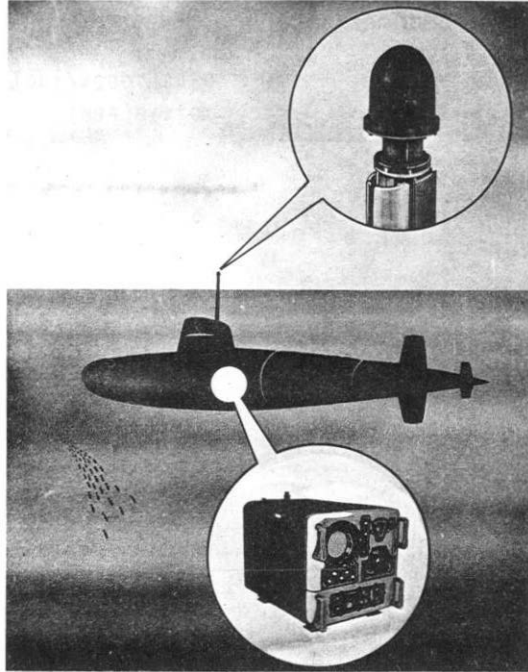

DIRECTION FINDER SET AN/BRD-5

**FUNCTIONAL DESCRIPTION:**

Direction Finder Set AN/BRD-5 is a specialized multi-band radio receiver and antenna which determines the frequency and direction of received radio transmitter activity. This equipment is designed for use aboard submarines and has 17 bands for operation in the frequency range of 250 kc to 160 mc. The equipment monitors radio transmitter activity (frequency scanning) and indicates the bearing of an active transmitter (direction finding). Frequency scanning (panoramic) and direction finding are not simultaneous, but are instantaneously available. Antenna AS-1689 contains sense antennas, three loop antennas, and associated circuits. Radio Receiver R-1290/BRD-5 uses superheterodyne principles with provisions for visual display and audible monitoring of received radio signals. Bearings are determined with the aid of azimuth scales mounted around the face of Cathode-Ray Tube.

No field changes in effect at time of preparation (24 August 1965).

**RELATION TO OTHER EQUIPMENT:** None.

1.3 AN/BRD-5: 1

---

DIRECTION FINDER SET AN/BRD-5

---

**EQUIPMENT REQUIRED BUT NOT SUPPLIED:**

(1) Headset; (1) Flange or mounting plate; (1) 7 Conductor Cable; (1) 3 Conductor Cable; Stuffing tubes as required.

**TECHNICAL CHARACTERISTICS:**

**SENSITIVITY**

0.25-0.5 MC: 300 uv per meter.  
0.5-2.0 MC: 200 uv per meter.  
2.0-30.0 MC: 100 uv per meter.  
30.0-160.0 MC: 300 uv per meter.

FREQUENCY ACCURACY: 0.5%.

EQUIPMENT SELECTIVITY:  $\pm 2.0$  kc.

BEARING ACCURACY:  $\pm 5^\circ$ .

FREQUENCY RANGE: 250 kc to 160 mc.

**TUNING BANDS AND RANGE**

**LOW FREQUENCY**

BAND 1: 250-500 kc.  
BAND 2: 500-1000 kc.  
BAND 3: 1.0-2.0 mc.

**HIGH FREQUENCY**

BAND 4: 2.0-4.0 mc.  
BAND 5: 4.0-8.0 mc.  
BAND 6: 8.0-16.0 mc.  
BAND 7: 16.0-32.0 mc.

**VERY HIGH FREQUENCY CONVERTER**

BAND 30: 30.0-43.0 mc.  
BAND 43: 43.0-56.0 mc.  
BAND 56: 56.0-69.0 mc.  
BAND 69: 69.0-82.0 mc.  
BAND 82: 82.0-95.0 mc.  
BAND 95: 95.0-108.0 mc.  
BAND 108: 108.0-121.0 mc.  
BAND 121: 121.0-134.0 mc.  
BAND 134: 134.0-147.0 mc.  
BAND 147: 147.0-160.0 mc.

TYPE OF RECEPTION: A-0, A-1, A-2, A-3.

AUDIO OUTPUT: 6 milliwatts across 600 ohms.

INTERMEDIATE FREQUENCY: 175 kc for bands 1 through 3; double conversion (2.0 mc/175 kc) for bands 4 through 7; triple conversion (13-26 mc 2.0 mc/175 kc) for Converter 30.0-160.0 mc bands.

TYPE OF RECEIVER: Superheterodyne.

**OPERATING POWER**

PRIMARY: 115 v  $\pm 10\%$ , 60 cyc  $\pm 5\%$  single ph, 200 w nom.

OWN SHIP'S COURSE: 115 v, 60 cyc, single ph.

**DIRECTION FINDER SET AN/BRD-5**

**MAJOR COMPONENTS**

QTY	ITEM	DIMENSIONS (INCHES)	WEIGHT (LBS)
1	Direction Finder Set AN/BRD-5 includes:		740
1	Radio Receiver R-1290/BRD-5	19-1/2 x 22 x 27-5/32	200
1	Antenna AS-1689/BRD-5	18-5/16 x 29-45/64	505
1	Connector UG-1060/U	1-3/4	3 oz
10	Extender Cables		
1	Extraction Tool		
5	Allen Head Wrenches		
2	Alignment Tools		

**REFERENCE DATA AND LITERATURE:**

NAVSHIPS 96006: Technical Manual for Direction Finder Set AN/BRD-5.

**TUBE, CRYSTAL AND/OR SEMI-CONDUCTOR DATA:**

TUBES: (3) 5670 (9) 5749 (2) 5725 (7) 5654 (4) 5750 (5) 5726 (10) 5721  
(1) 5696 (1) 5CP1A (1) 6AK6WA

CRYSTALS: (1) 56 mc (1) 69 mc (1) 95 mc (1) 121 mc (1) 147 mc (1) 82 mc  
(1) 103 mc (1) 134 mc (1) 160 mc

SEMI-CONDUCTORS: (6) 1N540 (4) 1N752A (14) 1N3064 (3) 1N647M (2) 1N3277 (2) 1N3029B  
(1) 2N1050A (3) 2N1613 (1) 2N389 (6) 2N918 (40) 2N917

**SHIPPING DATA**

PKGS	VOLUME (CU FT)	WEIGHT (LBS)
6	33.6	870

**PROCUREMENT DATA**

PROCURING SERVICE: USN DESIGN COG: USN, BuShips  
SPEC &/OR DWG: MIL-D-15747 Rev B

CONTRACTOR	LOCATION	CONTRACT OR ORDER NO.	APPROX. UNIT COST
Sanders Associates Inc.	Plainview Long Island, N. Y.	NOBSR-7209	

1.3 AN/BRD-5: 3

132

27 July 1964

Cog Service: USN

FSN:

RECEIVING SET, RADIO AN/DRW-29

Functional Class:

USA

USN

USAF

TYPE CLASS:

Used by

MANUFACTURER'S NAME/COE NUMBER: Babcock Electronics Corp., (82050).



RECEIVING SET, RADIO AN/DRW-29

**FUNCTIONAL DESCRIPTION:**

Receiving Set, Radio AN/DRW-29 is intended for installation in pilotless aircraft wherein the output functions of the receiving set can be utilized to control various functions of the aircraft. The receiving set is capable of receiving and demodulating a UHF, FM coded, radio control signal in the frequency range of 406 to 550 megacycles, and having maximum modulation deviation of either  $\pm 120$  or  $\pm 300$  kilocycles (selectable). The receiving set can demodulate, or decode, a signal that is frequency-modulated, or coded by as many as 6 of a possible 20 preselected, specified audio-frequency modulation signals simultaneously. Each of the 20 audio-frequency modulating signals represent specific control commands which appear as relay closures at the output of the receiving set.

No field changes in effect at time of preparation (15 May 1964).



---

**AN/DRW-29 RECEIVING SET, RADIO**

---

**RELATION TO OTHER EQUIPMENT:****EQUIPMENT REQUIRED BUT NOT SUPPLIED:****TECHNICAL CHARACTERISTICS:****INPUT POWER**VOLTAGE: 27.5  $\pm$  0.5 v dc.

POWER CONSUMPTION: 7.5 W nom, 8.25 W max.

**RF SECTION**

SENSITIVITY: 10 uv to 2 v under normal conditions; 40 uv to 2 v under extreme environmental conditions.

FREQUENCY RANGE: 406 to 550 mc, by means of plug in crystals.

FREQUENCY STABILITY:  $\pm$  0.01%.

ANTENNA INPUT IMPEDANCE: 52 ohms nom.

MAXIMUM ALLOWABLE FM DEVIATION OF CARRIER: 300 kc.

**IF SECTION**

INTERMEDIATE FREQUENCY: 33.5 uv.

**OUTPUT SECTION**

TYPE OF OUTPUT: Relay closures, which make or break connections to external control mechanisms.

AUDIO DECODER FREQUENCIES: 7.5 to 73.95 kc.

TOTAL NUMBER OF OUTPUTS AVAILABLE: 20 SPDT-type relay closures (channels 1 to 20) plus 10 SPST type relay closures (channels 1 to 5 and 11 to 15) controlled by audio frequency coding (modulation) of received signal.

**MAJOR COMPONENTS**

---

QTY	ITEM	STOCK NUMBERS	DIMENSIONS (INCHES)	WEIGHT (LBS)
1	Receiving Set, Radio AN/DRW-29 includes:		6-29/32 x 7-1/2 x 9-3/16	10
1	Mounting Base MT(2740)DRW-29		2-1/4 x 6-1/2 x 9-3/16	1
1	Radio Receiver R-1136/DRW-29		5-13/32 x 6-29/32 x 9-3/16	9

---

**REFERENCE DATA AND LITERATURE:**NAVWEPS 16-30DRW29-1: Handbook of Operation, Service, and Overhaul Instructions for Receiving Set, Radio, AN/DRW-29.

---

**TUBE, CRYSTAL AND/OR SEMI-CONDUCTOR DATA:**

TUBES: None required.

CRYSTALS: (As required) CR-77/U

1.4 AN/DRW-29: 2

---

---

RECEIVING SET, RADIO AN/DRW-29

---

SEMI-CONDUCTORS: (1) 22376-1 (1) 2N335 (1) 22376-2 (1) 2N32BA (2) 2N1305  
(1) 1N752A (1) 1N3023B (2) 1N746A (1) 1N2326

---

SHIPPING DATA

---

PKGS	VOLUME (CU FT)	WEIGHT (LBS)
------	----------------	--------------

---

---

PROCUREMENT DATA

---

PROCURING SERVICE: USN DESIGN COG: USN, BuWeps  
SPEC &/OR DWG:

---

CONTRACTOR	LOCATION	CONTRACT OR ORDER NO.	APPROX. UNIT COST
Babcock Electronics Corp.	Costa Mesa, California	N0w(A)-62-0619-r	

---

21 July 1967

MULTIPLEXER SET AN/FCC-17

Cog Service: USN FSN:

Functional Class:

USA

USN

USAF

TYPE CLASS:

Used by

MANUFACTURER'S NAME/CODE NUMBER: Lenkurt Electric Co., Inc., (83744).

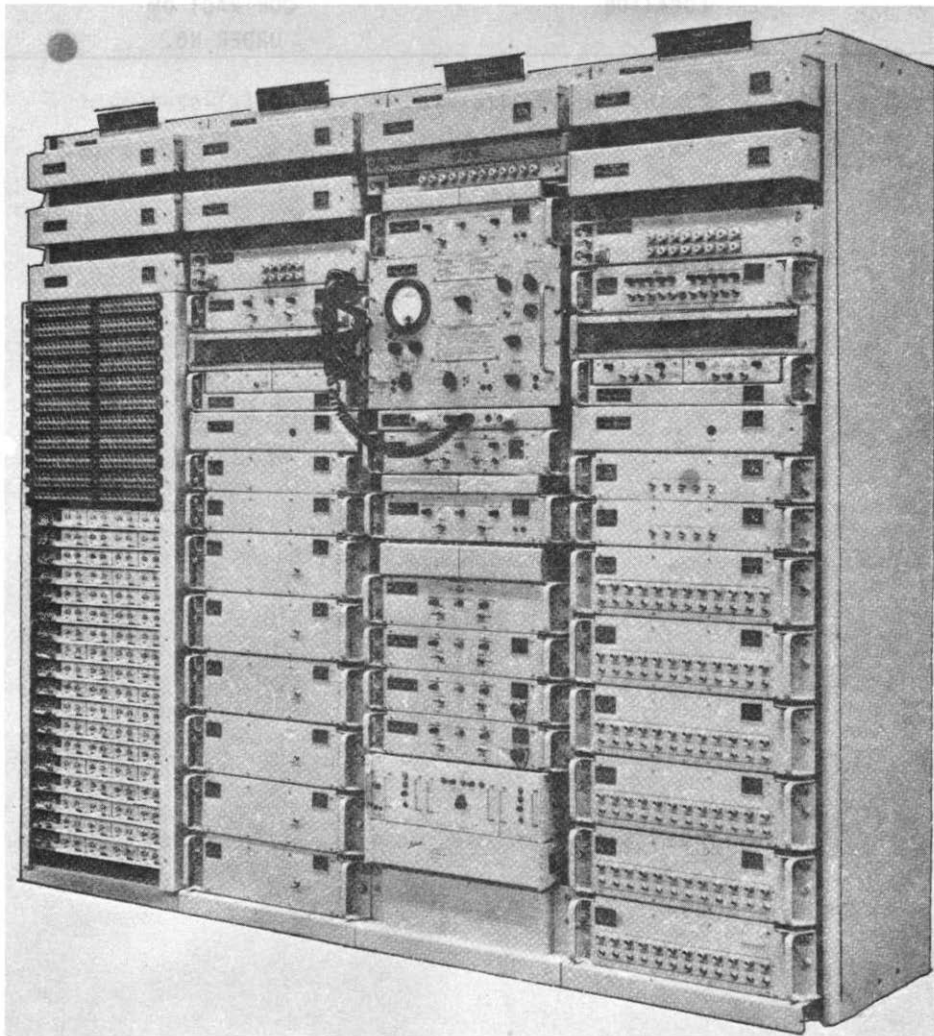

MULTIPLEXER SET AN/FCC-17

1.5 AN/FCC-17: 1

---

**MULTIPLEXER SET AN/FCC-17**

---

**FUNCTIONAL DESCRIPTION:**

Multiplexer Set AN/FCC-17 is an all solid state, 600 channel universal multiplex set designed for military communications systems. Capable of full data loading--data transmission on any or all 600 channels simultaneously-- the AN/FCC-17 is an advanced multiplex system designed for data and voice transmission. The AN/FCC-17 provides absolute synchronization without regard to error accrued in the transmission medium. In addition, the oscillator locks on the last corrected frequency until the return of the pilot signal in the event of a loss of the pilot frequency. The set is a fixed installation, single side-band suppressed carrier, frequency-division multiplexer set providing facilities for the simultaneous transmission and reception of up to 60 signals over a single radio or wire-link system. It has 60 channels and may be expanded to 600 channels by the use of additional components.

No field changes in effect at time of preparation (26 April 1967).

**RELATION TO OTHER EQUIPMENT:** None.

**EQUIPMENT REQUIRED BUT NOT SUPPLIED:** None

**TECHNICAL CHARACTERISTICS:**

**POWER REQUIREMENTS:** 120 v ac, 60 cyc, single ph; 48 v dc.

**MAJOR COMPONENTS**

QTY	ITEM	DIMENSIONS (INCHES)	WEIGHT (LBS)
1	Multiplexer Set AN/FCC-17 includes:		
5	Rack, Electrical Equipment MT-2512/FCC-17		
1	Amplifier, Assembly AM 2382/FCC-17		
5	Multiplexer, TD 309/GCC		
1	Frequency Supply, Telephone Carrier TA-397/GCC		
5	Demultiplexer, TD-308/GCC		
1	Control Monitor C-3114/GCC		
3	Power Supply Assembly PP-2743/FCC-17		
2	Support, Modern Telephone MT-2478/GCC		
1	Translator, Signal Data MD-428/FCC-17		
1	Translator, Signal Data MD-438/FCC-17		
1	Multiplexer, TD-421/GCC		
1	Demultiplexer TD-420/GCC		
1	Frequency Supply, Telephone Carrier TA-419/FCC-17		
1	Frequency Supply, Telephone Carrier TA-418/FCC-17		
1	Amplifier Assembly, AM-2995/FCC-17		
1	Frequency Supply, Telephone Carrier TA-414/GCC		
1	Telephone Carrier TA-405/GCC		
12	Terminal Board Assy J-1244/GCC		
3	Panel, Fuse SB-1276/FCC-17		
1	Panel, Fuse SB 1296/FCC-17		
1	Network Combining MX-3570/FCC-17		
1	Panel, Fuse SB 1295/FCC-17		
2	Jack Assy, Telephone TA-417/FCC-17		
1	Network, Combining MX-3569/FCC-17		

1.5 AN/FCC-17: 2

**MULTIPLEXER SET AN/FCC-17**

QTY	ITEM	DIMENSIONS ( INCHES)	WEIGHT (LBS)
1	Panel, Fuse SB-1294/FCC-17		
1	Control-Indicator C-3394/FCC-17		

**REFERENCE DATA AND LITERATURE:**

Lenkurt Electric Co., Inc. Catalog for Microteletype 74B, 7125-8400 Megacycle Microwave.

**SHIPPING DATA**

PKGS	VOLUME (CU FT)	WEIGHT (LBS)

**PROCUREMENT DATA**

PROCURING SERVICE: USN  
 SPEC &/OR DWG:

DESIGN COG: USN, NavShips

CONTRACTOR	LOCATION	CONTRACT OR ORDER NO.	APPROX. UNIT COST
Lenkurt Electric Co., Inc.	San Carlos, Calif.	N600 61082	
		N600 61608	
		N600 62023	
		N600 62093	
		N600 62244	
		N600 63243	
		N600 63529	

3 August 1967

TERMINAL TELEGRAPH AN/FCC-34

Cog Service: USN

FSN:

Functional Class:

USA

USN

USAF

TYPE CLASS:

Used by

MANUFACTURER'S NAME/CODE NUMBER: Steima, Incorporated, (96238).

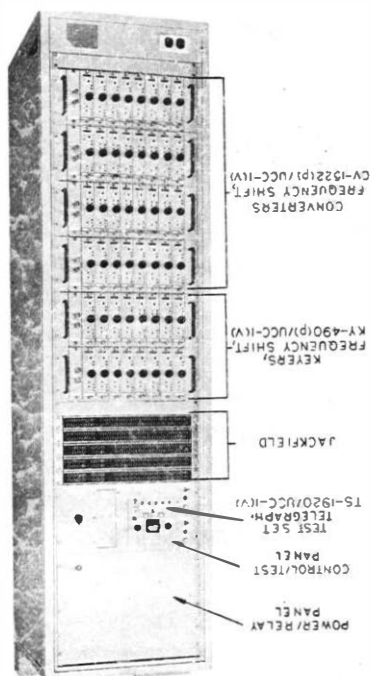

TERMINAL TELEGRAPH AN/FCC-34

**FUNCTIONAL DESCRIPTION:**

The Terminal Telegraph AN/FCC-34 is a modular carrier-telegraph equipment intended for use with single-sideband or twin sideband radio circuits, voice-frequency wire lines, or microwave circuits. The Telegraph Terminal's component quantities are fixed, so that only two configurations are possible. System configurations are switch selectable, locally or from a remote location.

No field changes in effect at time of preparation (5 April 1966).

**RELATION TO OTHER EQUIPMENT:** None.

**EQUIPMENT REQUIRED BUT NOT SUPPLIED:**

(1) Multimeter: AN/PSM-4A;

1.5 AN/FCC-34: 1

**TERMINAL TELEGRAPH AN/FCC-34**

- (1) Electronic Multimeter: ME-62/U;
- (1) Multimeter: AN/PSM-4C;
- (1) Oscilloscope: AN/USM-105A;
- (1) Frequency Meter: AN/TSM-16;
- (1) Transistor Test Set: TS-1100A/U;
- (1) Test Set, Telegraph: AN/GGM-1;
- (6) Technical Manuals: NAVSHIPS 92051, 92423, 93277, 93658A, 94244 and TM11-2698.

**TECHNICAL CHARACTERISTICS:**

MULTIPLEXING DATA: Frequency-division type.

CHANNELS: 16 (narrow band).

TRANSMITTING CHANNELS: 16 (keyers).

RECEIVING CHANNELS DUAL: 16 (converters).

FREQUENCY RANGE: 425 to 2975 cycles.

SPACING BETWEEN CHANNELS: 170 cps.

WORDS PER MINUTE: 100 max; operational speed each channel.

LOOP DATA: dc actuated, full duplex operation, link type selection.

TERMINATION: 2-wire line.

POWER REQUIREMENT: 115 or 230 v ac, 50 to 60 cps, single ph; 179 watts.

The equipment can provide up to:

- 16 narrow-band channels when operating in a space-diversity combination, or 8 narrow-band channels when operating in a space and frequency-diversity combination.

The equipment operates in a 375-to-3025 cps bandwidth, regardless of diversity combination.

**MAJOR COMPONENTS**

QTY	ITEM	DIMENSIONS (INCHES)	WEIGHT (LBS)
1	Terminal Telegraph AN/FCC-34 includes:	22-3/8 x 24 x 84	
1	Cabinet, Electrical Equipment Steelma Model IC-16/32	22-3/8 x 24 x 87-9/16	225
16	Keyer, Frequency Shift: KY-490(P)/UCC-1(V)	1-5/8 x 6-3/4 x 19-1/2	4-1/2
32	Converter, Frequency Shift: CV-1522(P)/UCC-1(V)	1-5/8 x 6-3/4 x 19-1/2	5-1/2
1	Test Set, Telegraph (Rack Mounted) TS-1920/UCC-1(V)	4 x 5-3/4 x 6-1/2	3-3/8
2	Technical Manual: NAVSHIPS 94787	1-1/2 x 8-1/4 x 10-3/4	
2	Supplementary Technical Manual NAVSHIPS: 0967-010-5000	3/4 x 8-1/4 x 10-3/4	

**REFERENCE DATA AND LITERATURE:**

NAVSHIPS 0967-010-5000: Supplementary Technical Manual for Telegraph Terminal AN/FCC-34.

---

TERMINAL TELEGRAPH AN/FCC-34

---

SHIPPING DATA

PKGS

VOLUME (CU FT)

WEIGHT (LBS)

PROCUREMENT DATA

PROCURING SERVICE: USN

DESIGN COG: USN, SUSHIPS

SPEC &/OR DWG: MIL-C-23361(SHIPS) Mod 3

CONTRACTOR

LOCATION

CONTRACT OR  
ORDER NO.

APPROX.  
UNIT COST

Stelma, Incorporated

Stamford, Conn.

N0bsr-91112



23 July 1964

REPEATER-MONITOR GROUP, TELEGRAPH AN/FGA-8

Cog Service: USN FSN: 2F6115-973-4761

Functional Class:

USA

USN

USAF

TYPE CLASS:

Used by

MANUFACTURER'S NAME/CODE NUMBER: Stelma Incorporated, (96238).

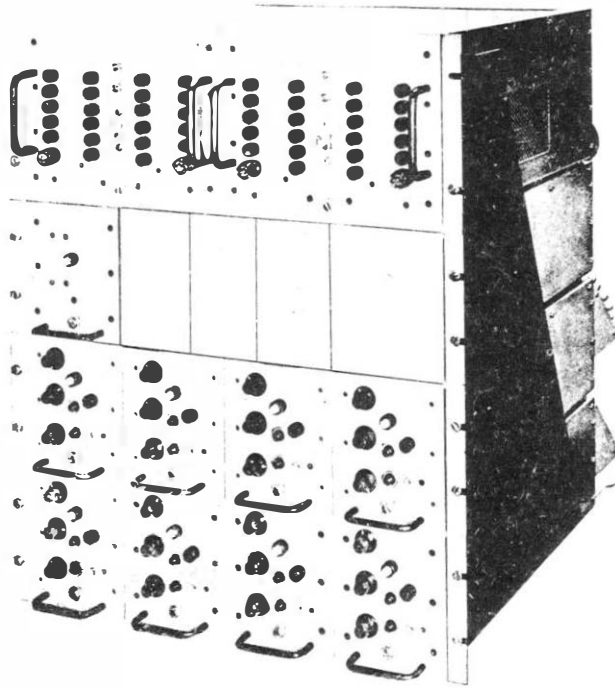

REPEATER-MONITOR GROUP, TELEGRAPH AN/FGA-8

**FUNCTIONAL DESCRIPTION:**

Repeater-Monitor Group, Telegraph AN/FGA-8 provides facilities for monitoring, regenerating, and repeating eight channels of synchronous, 6 unit code telegraph signals at one of four different modulation rates (37.5 baud, 61.1 baud, 150 baud, and an optional rate between 37.5 baud and 150 baud). It also provides facilities for detecting excessive distortion and no-transition conditions within each telegraph circuit.

No field changes in effect at time of preparation (1 July 1964).

**RELATION TO OTHER EQUIPMENT:**

---

## AN/FGA-8 REPEATER-MONITOR GROUP, TELEGRAPH

---

### EQUIPMENT REQUIRED BUT NOT SUPPLIED:

(1) Multimeter AN/TSM-4C; (1) Oscilloscope AN/USM-105A; (1) Teletypewriter Test Set AN/GGM-1.

### TECHNICAL CHARACTERISTICS:

#### REPEATER-MONITOR, TELEGRAPH TH-45/FGA-6

##### DATA/TELEGRAPH INPUT SIGNALS

TYPE: Synchronous, 6 unit code.

CURRENT: 20 or 60 ma (neutral),  $\pm 10$  or  $\pm 30$  ma (polar).

INPUT IMPEDANCE: 135 ohms (60 ma); 270 ohms (30 ma); 410 ohms (20 ma); 820 ohms (10 ma).

##### SIGNAL RATES

FIXED: 37.5, 61.1, or 150 baud, nom.

OPTIONAL: 37.5 through 150 baud, nom.

INPUT TIMING SIGNALS: Square wave, 0 to - 2 v, 128 times baud-rate.

##### FREQUENCIES

FIXED: 4800.00, 7826.13, and 19200.0 cps.

OPTIONAL: 4800.00 through 19200.0 cps (supplied by the TD-542/FGA-6 or ext timing equip).

##### SYNCHRONIZATION

###### RATE

NORMAL MODE (AUTOMATIC): To within 2% in 1000 mark-to-space transition.

RAPID PHASE MODE (MANUAL): To within 10% of synchronization within 64 mark-to-space transitions.

STABILITY: Synchronization is maintained for at least 30 minutes without an input signal.

POWER REQUIREMENTS (SUPPLIED BY POWER SUPPLY): + 12 v dc, 0.3 W; - 12 v dc, 2.7 W.

OPERATING TEMPERATURE RANGE: 0 to + 55 deg C.

##### REGENERATIVE-REPEATER SECTION

INPUT DISTORTION TOLERANCE: 45% of a baud (max).

##### OUTPUT SIGNALS

TYPE: Neutral or polar, dry-contact relay.

DISTORTION: 2% of a baud (max).

##### MONITOR SECTION

DISTORTION-SENSING RANGE: 5 to 45% in 5% steps.

DISTORTION-SENSING ACCURACY:  $\pm 3\%$ .

NUMBER OF HITS TO ALARM: 1 to 10 (switch selected).

NO-TRANSITION ALARM: Absence of input or output (optional) signal transitions for 6 sec (nom).

DISTORTION MONITORING RESET INTERVAL: 3 minutes.

##### OUTPUT SIGNALS

HIT ALARM: Relay, dry-contact closure during alarm condition.

NO-TRANSITION ALARM: Relay, dry-contact closure during alarm condition.

#### GENERATOR, SWEEP TD-542/FGA-6

OSCILLATOR FREQUENCY: 153.600 kc and 125.218 kc.

##### OUTPUT TIMING SIGNALS

TYPE: Square wave, + 2 to - 2 v.

##### FREQUENCIES

FIXED: 4800.00, 7826.13 and 19200.0 cps.

---

**REPEATER-MONITOR GROUP, TELEGRAPH AN/FGA-8**

---

OPTIONAL: 4800.00, 7826.13, 9600.00, 15652.2, 19200.0, 31304.5, 38400.0 and 62609.0 cps.

STABILITY: One part in 1 million per 24 hr period.

FREQUENCY DETERMINING ELEMENTS: Temp controlled xtal.

OPERATING TEMPERATURE RANGE: 0 to + 55 deg C.

POWER REQUIREMENTS (SUPPLIED BY POWER SUPPLY): + 12 v dc, 1.6 W; - 12 v dc, 3.3 W.

POWER SUPPLY PP-3271/FGA-6

OUTPUT: + 12 v dc, 0.8 amp max; - 12 v dc, 3 amp max; 115 v ac (to mechanical timer), 5 W.

VOLTAGE REGULATION: ± 3% for dc outputs.

OPERATING TEMPERATURE RANGE: 0 to + 55 deg C.

INPUT: 115 or 230 v, 50 to 60 cyc, single ph, 150 W.

AUTOMATIC SWITCH-OVER VOLTAGE: 1 v down (+ 12 v dc or - 12 v dc outputs).

---

**MAJOR COMPONENTS**

---

QTY	ITEM	STOCK NUMBERS	DIMENSIONS (INCHES)	WEIGHT (LBS)
1	Repeater-Monitor Group, Tele-	2F6115-973-4761		
	graph AN/FGA-8 includes:			
8	Repeater-Monitor, Telegraph		4-3/8 x 5-1/4 x 18-1/2	6.25
	TH-45/FGA-6			
1	Generator, Sweep TD-542/FGA-6		4-3/8 x 5-1/4 x 18-1/2	6.75
2	Power Supply PP-3271/FGA-6		6-15/16 x 8-3/4 x 18-1/2	17.50
1	Cabinet, Electrical Equipment		5-1/4 x 19 x 21-1/2	4.50
	CY-3869/FGA-8			
1	Cabinet, Electrical Equipment		7 x 19 x 21-1/2	4.75
	CY-3867/FGA-8			
1	Cabinet, Electrical Equipment		5-1/4 x 19 x 21-1/2	5.50
	CY-3868/FGA-8			

---

**REFERENCE DATA AND LITERATURE:**

NAVSHIPS 94679: Technical Manual for Repeater-Monitor Group, Telegraph AN/FGA-8.

---

**TUBE, CRYSTAL AND/OR SEMI-CONDUCTOR DATA:**

TUBES: None used.

CRYSTALS: (1) 125.218 kc (1) 153.6 kc

SEMI-CONDUCTORS: (92) 1N270 (10) 1N457 (22) 1N538 (2) 1N752A (9) 1N1341 (2) 1N3016R  
(1) 2N297A (2) 2N1184 (10) 2N1304 (106) 2N1305 (2) 3N51

---

**SHIPPING DATA**

---

PKGS	VOLUME (CU FT)	WEIGHT (LBS)
------	----------------	--------------

---

---

**AN/FGA-8 REPEATER-MONITOR GROUP, TELEGRAPH**

---

---

**PROCUREMENT DATA**

---

PROCURING SERVICE: USN  
SPEC &/OR DWG:

DESIGN COG: USN, BuShips

---

<b>CONTRACTOR</b>	<b>LOCATION</b>	<b>CONTRACT OR ORDER NO.</b>	<b>APPROX. UNIT COST</b>
Stelma Incorporated Type No. RMF-8	Stamford, Connecticut	N0bsr-87552	\$13882.00

---

4 April 1966

Cog Service: USN FSN:

TELETYPEWRITER SET AN/FGC-38A  
Functional Class:

USA

USN

USAF

TYPE CLASS:

Used by

MANUFACTURER'S NAME/CODE NUMBER: TELETYPE Corporation, (59433).

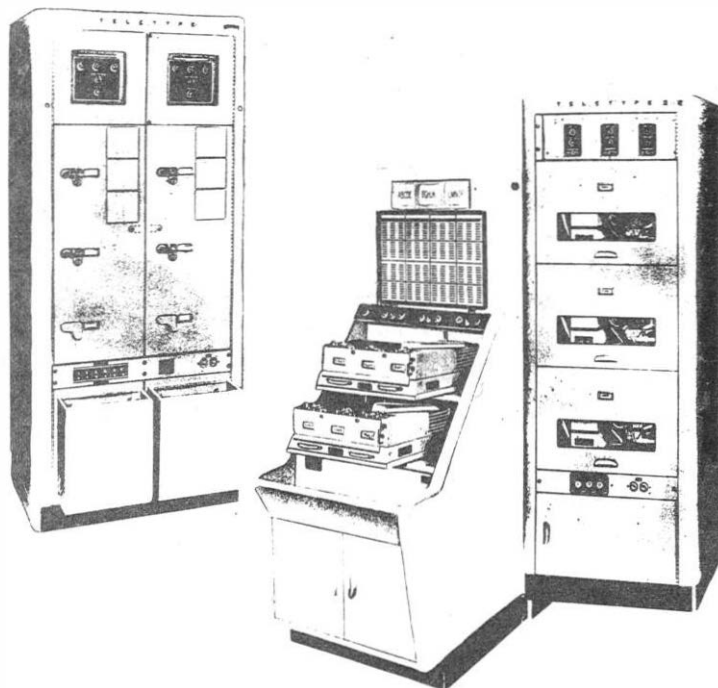

TELETYPEWRITER SET AN/FGC-38A

**FUNCTIONAL DESCRIPTION:**

Teletypewriter Set AN/FGC-38A is used at a relay station to receive, transmit, and monitor telegraph messages. The equipment is composed of a transmitter group, a receiver group, and a monitor group.

No field changes in effect at time of preparation (11 February 1966).

**RELATION TO OTHER EQUIPMENT:**

The AN/FGC-38A is functionally interchangeable with AN/FGC-38 except for different component units.

**EQUIPMENT REQUIRED BUT NOT SUPPLIED:** None.

**TECHNICAL CHARACTERISTICS:**

**POWER SUPPLY REQUIREMENTS**

1.5 AN/FGC-38A: 1

**TELETYPEWRITER SET AN/FGC-38A**

INPUT VOLTAGE: 115 v, ac,  $\pm 10\%$ .

PHASE: Single.

FREQUENCY: 60 cps  $\pm 0.5$  cps for synchronous motors.

**INPUT CURRENT**

TRANSMITTER GROUP: 8.15 amp approx.

RECEIVER GROUP: 10.79 amp approx.

MONITOR GROUP: 11.2 amp approx.

**POWER FACTOR**

TRANSMITTER GROUP: 0.43 approx.

RECEIVER GROUP: 0.34 approx.

MONITOR GROUP: 0.36 approx.

**WATTAGE**

TRANSMITTER GROUP: 400 w.

RECEIVER GROUP: 416 w.

MONITOR GROUP: 460 w.

**PERMISSIBLE TEMPERATURES**

STORAGE AMBIENT TEMPERATURE:  $-40$  to  $+65^{\circ}$  C ( $-40$  to  $+149^{\circ}$  F).

OPERATING AMBIENT TEMPERATURE:  $0$  to  $+50^{\circ}$  C ( $+32$  to  $+122^{\circ}$  F).

**MAJOR COMPONENTS**

QTY	ITEM	STOCK NUMBERS	DIMENSIONS (INCHES)	WEIGHT (LBS)
1	Teletypewriter Set AN/FGC-38A			1980
	includes:			
1	Transmitter Group OA-615A/FGC-38A			538
1	Receiver Group OA-616A/FGC-38			756
1	Monitor Group OA-617A/FGC-38			646

147

**REFERENCE DATA AND LITERATURE:**

NAVSHIPS 92833: Technical Manual for Teletypewriter Sets AN/FGC-38A, AN/FGC-38AX and AN/FGC-39A.

**SHIPPING DATA**

PKGS	VOLUME (CU FT)	WEIGHT (LBS)
17	280	4066

**PROCUREMENT DATA**

PROCURING SERVICE: USN  
SPEC &/OR DWG:

DESIGN COG: USN, BuShips

CONTRACTOR	LOCATION	CONTRACT OR ORDER NO.	APPROX. UNIT COST
Teletype Corporation	Skokie, Illinois	N0bsr 64643	

4 April 1966

ROUTING SET TELETYPEWRITER AN/FGC-71(V)

Cog Service: USN FSN:

Functional Class:

USA

USM

USAF

TYPE CLASS:

Used by

MANUFACTURER'S NAME/CODE NUMBER: ITT Kellogg, (33031).

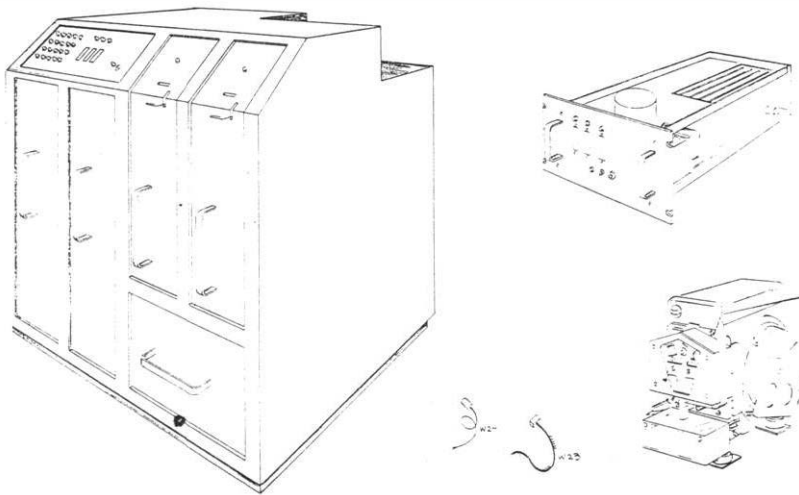

ROUTING SET TELETYPEWRITER AN/FGC-71(V)

**FUNCTIONAL DESCRIPTION:**

Routing Set Teletypewriter AN/FGC-71(V) accepts multiple address punched tape messages and reproduces them for as many as twenty different sets of transmitting equipment. Each reproduced tape is similar to the input tape except that routing indicators are removed at each output for those routings that a particular transmitter does not service.

No field changes in effect at time of preparation (2 December 1965).

**RELATION TO OTHER EQUIPMENT:** None.

**EQUIPMENT REQUIRED BUT NOT SUPPLIED:** None.

**TECHNICAL CHARACTERISTICS:**

**TRANSMISSION CIRCUITS**

INPUT: (reader heads; 2 (5 level)).

1.5 AN/FGC-71(V): 1

**ROUTING SET TELETYPEWRITER AN/FGC-71(V)**

OUTPUT: 20 (6 level).

TRANSMIT SIGNALS

BINARY PERMUTATION CODE: 6 levels.

CONTROL: Tape feed, punch and acenable.

VOLTAGE: 12 v dc.

WORDS PER MINUTE: 625.

CHARACTERS PER SECOND: 62.5

PROGRAM CAPABILITY

ROUTING INDICATORS: 88.

ROUTING INDICATOR CHARACTERS: 4 to 8.

TELETYPEWRITER REPERFORATORS

STANDARD MESSAGES: 19.

OVERFLOW MESSAGES: 1.

CRESENT CODE: 1 through 15.

POWER REQUIREMENTS: 117 v ac  $\pm$  10%, 60 cps  $\pm$  10% single ph.

POWER CONSUMPTION: 350 watts max.

REPERFORATOR CONTROL

INPUT SIGNALS: 6 level binary punch and control (tape feed, ac enable and syne).

VOLTAGE LEVEL

BINARY PUNCH AND CONTROL: 12 v dc.

SYNC (110 CHARACTERS/SEC): 6 v ac.

OUTPUT SIGNALS: 6 level binary, tape feed, and ac motor control.

VOLTAGE LEVEL

BINARY PUNCH AND TAPE FEED: 30 v dc.

AC MOTOR CONTROL: 12 v dc.

POWER REQUIREMENTS: 117 v ac  $\pm$  10%, 60 cps  $\pm$  10% single ph.

REPERFORATOR

OPERATING SPEED: 1100 wpm.

INPUT SIGNALS: 6 level binary code and tape feed.

VOLTAGE LEVEL: 30 v dc.

AMPERES: 7.

PUNCH LEVELS: 6.

POWER REQUIREMENTS: 117 v ac  $\pm$  10%, 6 cps  $\pm$  10%, single ph.

AC POWER CONSUMPTION: 65 watts max.

AMPERES

START: 9.

RUN: 1.B5.

**MAJOR COMPONENTS**

QTY	ITEM	STOCK NUMBERS	DIMENSIONS (INCHES)	WEIGHT (LBS)
1	Routing Set, Teletypewriter AN/FGC-71(v) includes:			
1	Console, Routing Set, Tele- typewriter C-3752/FGC-71(v)		24 x 35 x 47	
20	Control, Reperforator Tele- typewriter C-3753/FGC-71(v)		6-3/4 x 11 x 11-3/4	
20	Teletypewriter, Reperforator TT-329/UG		8 x 12 x 16-1/2	24-1/2

1.5 AN/FGC-71(v): 2



**ROUTING SET TELETYPEWRITER AN/FGC-71(V)**

QTY	ITEM	STOCK NUMBERS	DIMENSIONS (INCHES)	WEIGHT (LBS)
20	Cable, Interconnecting, W24			
20	Cable, Interconnecting, W23			
581	Leads, Patching			

**REFERENCE DATA AND LITERATURE:**

NAVSHIPS 94125: Final Instruction Manual for Teletypewriter Routing Set AN/FGC-71(V).

**TUBE, CRYSTAL AND/OR SEMI-CONDUCTOR DATA:**

TUBES: Not required.

CRYSTALS: Not required.

SEMI-CONDUCTORS: (1) 1N527 (1) 1.5122 (1) 1N30228 (231) PS1005 (8) 2N1183B  
(38) 100682 (158) 101765-2486

**SHIPPING DATA**

PKGS	VOLUME (CU FT)	WEIGHT (LBS)

**PROCUREMENT DATA**

PROCURING SERVICE: USN  
SPEC &/OR DWG:

DESIGN COG: USN, BuShips

CONTRACTOR	LOCATION	CONTRACT OR ORDER NO.	APPROX. UNIT COST
ITT Kellogg	Chicago, Illinois	N00sr 85200	

150

9 June 1966

Cog Service: USN FSN:

ROUTING SET TELETYPEWRITER AN/FGC-73(V)  
Functional Class:

USA

USN

USAF

TYPE CLASS:

Used by

MANUFACTURER'S NAME/CODE NUMBER: Elgin National Watch Co., Communications Division, (20209).

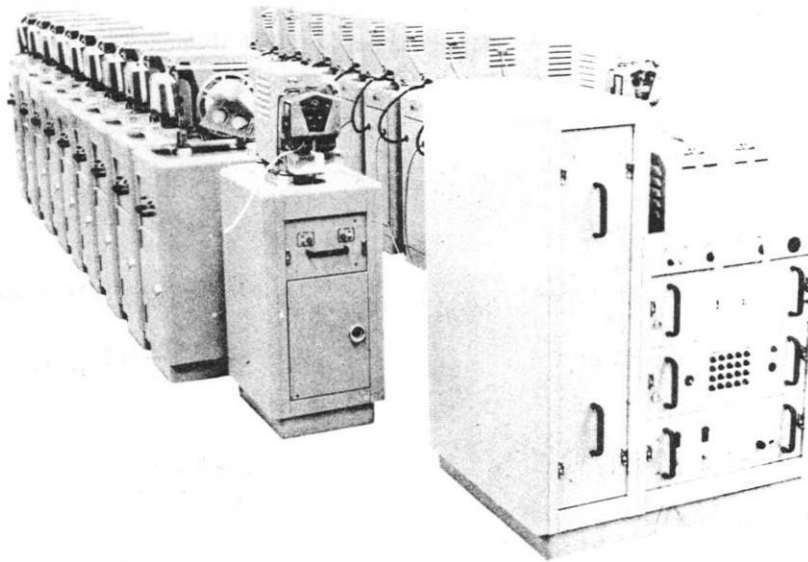

ROUTING SET TELETYPEWRITER AN/FGC-73(V)

**FUNCTIONAL DESCRIPTION:**

The AN/FGC-73(v) is a high-speed teletypewriter routing set. It reads teletypewriter perforated tape, provides segregation of multi-address messages and reperforges tapes up to 20 simultaneously at 850 words per minute. The reperforged tape contains identical text and control codes, but only the addresses are patched in through the address decoding circuitry. Up to 96 eight character routing indicators may be programmed in Teletypewriter Routing Set Console OA-4042/FGC-73(v); up to 18 routing indicators to any one Teletypewriter Reperforator TT-329/UG; and one TT-329/UG accepts any routing indicator not programmed.

No field changes in effect at time of preparation (25 January 1966).

**RELATION TO OTHER EQUIPMENT:** None.

**EQUIPMENT REQUIRED BUT NOT SUPPLIED:**

(1) Patching Tool Burndy Engineering Co. RXT20-4; (1) Connector Tool Amp Inc. 16-20 Type 2, 305183; (20) Interconnecting Cable; (1) Oscilloscope Tektronix, Inc., Model 543; (1) Pulse

---

---

## ROUTING SET TELETYPEWRITER AN/FGC-73(V)

---

---

Generator Tektronix, Inc., Model 161; (1) waveform Generator Tektronix, Inc., Type 162.

### TECHNICAL CHARACTERISTICS:

OPERATING POWER REQUIREMENT: 115 v, 60 cyc single ph, 46 amp 5.3 kw.

OVERLOAD PROTECTION: Circuit Breakers.

OPERATING TEMPERATURE RANGE: 0 deg C to + 50 deg C (Continuous).

NON-OPERATING TEMPERATURE RANGE: - 15 deg C to + 75 deg C.

TAPE INPUT: Standard 11/16 in. wide, five-level, chad or chadless.

SPEED OF OPERATION: 850 wpm.

MECHANICAL DESIGN: Modular construction with plug-in printed circuit boards, completely transistorized.

### MAJOR COMPONENTS

QTY	ITEM	STOCK NUMBERS	DIMENSIONS (INCHES)	WEIGHT (LBS)
1	Routing Set, Teletypewriter AN/FGC-73(V) includes:			
1	Console, Routing Set, Teletypewriter OA-4042/FGC-73(V)		25-1/2 x 33-1/8 x 43	370
20	Control, Reperforator Teletypewriter C-4248/FGC-73(V)		14-9/16 x 19-11/16 x 29-1/2	119
22	Reperforator, Teletypewriter TT-329/UG		8 x 12 x 16-1/2	24-1/2
1100	Patching Leads			
2	Instruction Manual, NAVSHIPS 94492			
1	Instruction Manual, Model TT Core Memory			
1	Specification, Model CDS12TR5			
1	Instruction Manual, Model 30-12			
4	Technical Manual, High Speed Tape Punch Set Bulletin 215B			
4	Parts, High Speed Tape Punch Set Bulletin 1154B			
4	Technical Manual, Tape Reader Set Bulletin 267B			
4	Parts, High Speed Tape Reader Set Bulletin 1176B			

152

### REFERENCE DATA AND LITERATURE:

NAVSHIPS 94492: Instruction Manual for Teletypewriter Routing Set AN/FGC-73(V).

**ROUTING SET TELETYPEWRITER AN/FGC-73(V)**

**TUBE, CRYSTAL AND/OR SEMI-CONDUCTOR DATA:**

TUBES: Not required.

CRYSTALS: Not required.

SEMI-CONDUCTORS: (115) 2N1039 (40) 2N1039-1 (23) 2N1042-2 (3) 2N1046 (4) 2N1146  
 (8) 2N1175 (62) 2N1302 (5) 2N1308 (1) 2N1309 (5) 2N1499H  
 (1) 2N1539 (2) 2N2000 (2) 2N2067 (6) 2N241A (1) 2N378  
 (1641) 2N404 (4) 2N445 (2) 2N526 (9) 2N696 (2) AG1012 (4) 8Y121  
 (2) CER530 (4) CS-127 (1) CTS1812 (4) D1-52 (2) SGD100B (2) 005  
 (42) 1N1200 (20) 1N2976B (20) 1N3022 (2) 1N3024B (1) 1N388  
 (2080) 1N457 (20) 1N538 (225) 1237 (1436) 1238

**SHIPPING DATA**

PKGS	VOLUME (CU FT)	WEIGHT (LBS)
1	39.3	538
2-21	5.6	128
22-43	3.3	46
44-65	0.58	4-1/2

**PROCUREMENT DATA**

PROCURING SERVICE: USN  
 SPEC &/OR DWG:

DESIGN COG: USN, BuShips

CONTRACTOR	LOCATION	CONTRACT OR ORDER NO.	APPROX. UNIT COST
Elgin National Watch Co., Communications Division	Elgin, Illinois	NOpsr 87138	

153

6 April 1966

TELETYPEWRITER SET AN/FGC-74

Cog Service: USN FSN:

Functional Class:

USA

USN

USAF

TYPE CLASS:

Used by

MANUFACTURER'S NAME/CODE NUMBER: Teletype Corporation, (59433).

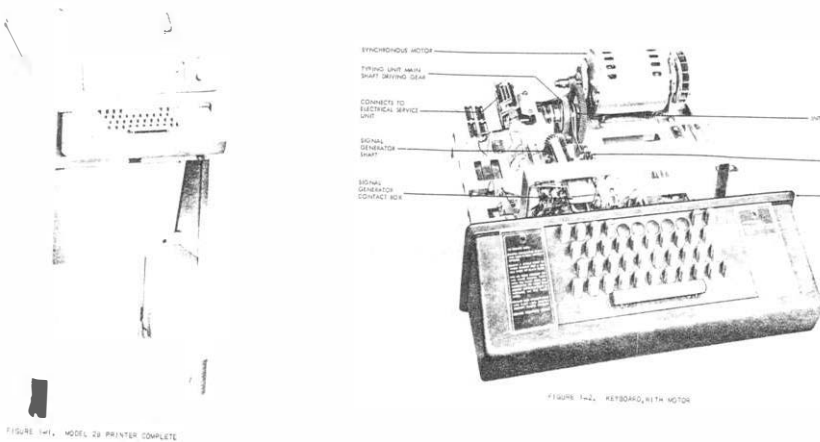

ORIGINAL

### TELETYPEWRITER SET AN/FGC-74

#### FUNCTIONAL DESCRIPTION:

The Teletypewriter Set AN/FGC-74 provides monitoring facilities for three receiver typing units plus a keyboard with switching facilities to connect in series any of the three receiver typing units. It is a fixed station for shore use. The unit has a standard communication keyboard, English characters, 72 characters per line, friction feed, synchronous motors, and 7.00 unit code. The equipment is a fixed shore unit.

No field changes in effect at time of preparation (31 January 1966).

RELATION TO OTHER EQUIPMENT: None.

EQUIPMENT REQUIRED BUT NOT SUPPLIED: None.

#### TECHNICAL CHARACTERISTICS:

The signaling frequency of the output telegraph signal is expressed in maximum dot cycles (one cycle is one current impulse followed by one no current impulse per second).

1.5 AN/FGC-74: 1

---

**TELETYPEWRITER SET AN/FGC-74**

---

SPEED	FREQUENCY
60 words per minute	22.8 cycles
67 words per minute	25 cycles
75 words per minute	28.5 cycles
100 words per minute	37.1 cycles

Equivalent speed in Baud is twice the frequency. The selector magnet responds to marking and spacing start-stop signals and may be connected for either 0.020 ampere or 0.060 ampere line current. The rectifier, when incorporated in the Electrical Service Unit, has sufficient output (0.120 ampere 115 v dc) to supply the selector magnet and the relay bias winding circuits. However, this rectifier does not have sufficient output to also supply the signal line current.

**POWER SUPPLY REQUIREMENTS**

(1) SYNCHRONOUS MOTOR UNIT

- (a) INPUT VOLTAGE: 115 volts  $\pm$  10 percent ac, single ph.
- (b) FREQUENCY: 60 cycles  $\pm$  0.75 percent.
- (c) INPUT CURRENT
  - STARTING: 9 amps.
  - RUNNING: 1.85 amps.
- (d) POWER FACTOR: 0.30.
- (e) WATTAGE: 65 watts.
- (f) HEAT DISSIPATION: 50 watts.

POWER REQUIREMENTS: 115 v dc.

**MAJOR COMPONENTS**

QTY	ITEM	STOCK NUMBERS	DIMENSIONS (INCHES)	WEIGHT (LBS)
1	Teletypewriter Set AN/FGC-74 includes:			
1	Cabinet Electrical Equipment CY-3689/FGC-74			
1	Teletypewriter keyboard Trans- mitter TT-385/UG			
1	AC Motor PD-17A/B			
2	AC Motor PD-96/UG			
3	Teletypewriter Typing Unit TT-386/UG			
3	Gear Set-455 Baud Mfgr's Part No. 173795			
3	Gear Set-50 Baud Mfgr's Part No. 163504			
3	Gear Set-75 Baud Mfgr's Part No. 163505			

**REFERENCE DATA AND LITERATURE:**

NAVSHIPS 94460: Teletype Instruction Manual No. 111MA for Teletypewriter Set AN/FGC-74 or 74X.

---

TELETYPEWRITER SET AN/FGC-74

---

SHIPPING DATA

PKGS                                      VOLUME (CU FT)                                      WEIGHT (LBS)

PROCUREMENT DATA

PROCURING SERVICE: USN  
SPEC &/OR DWG: 50138S

DESIGN COG: USN, BuShips

CONTRACTOR	LOCATION	CONTRACT OR ORDER NO.	APPROX. UNIT COST
Teletype Corporation Model No. 28	Skokie, Illinois	N0bsr 87305	

2 May 1966

Cog Service: USN FSN:

TELETYPEWRITER SET AN/FGC-74X  
Functional Class:

USA

USN

USAF

TYPE CLASS:

Used by

MANUFACTURER'S NAME/CODE NUMBER: Teletype Corporation, (59433).



FIGURE 14-1. MODEL 28 PRINTER COMPLETE

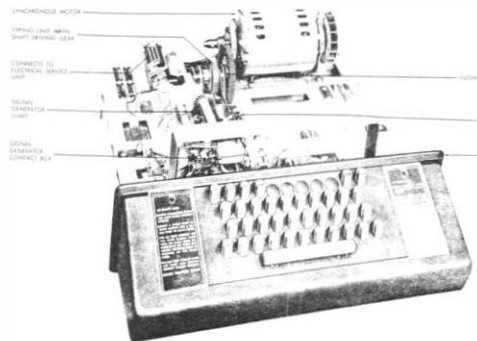

FIGURE 14-2. KEYBOARD WITH MOTOR

ORIGINAL

### TELETYPEWRITER SET AN/FGC-74X

#### FUNCTIONAL DESCRIPTION:

The Teletypewriter Set AN/FGC-74X is a Multiple Page Printer Monitor Console Set provides monitoring facilities for three receive typing units plus a keyboard with switching facilities to connect in series any of the three receive typing units, the equipment is a fixed shore unit.

No field changes in effect at time of preparation (31 January 1966).

RELATION TO OTHER EQUIPMENT: None.

EQUIPMENT REQUIRED BUT NOT SUPPLIED: None.

#### TECHNICAL CHARACTERISTICS:

The Signaling Frequency of the output telegraph signal is expressed in maximum dot

1.5 AN/FGC-74X: 1



**TELETYPEWRITER SET AN/FGC-74X**

cycles (one cycle is one current impulse followed by one no-current impulse) per second.

Speed	Frequency
60 words per minute	22.8 cycles
67 words per minute	25.0 cycles
75 words per minute	28.5 cycles
100 words per minute	37.1 cycles

Equivalent speed in Baud is twice the frequency. The selector magnet responds to marking and spacing start-stop signals and may be connected for either 0.020 ampere or 0.060 ampere line current. The rectifier, when incorporated in the Electrical Service Unit, has sufficient output (0.120 ampere, 115 v ac) to supply the selector magnet and the relay bias winding circuits. However, this rectifier does not have sufficient output to also supply the signal line current.

**POWER SUPPLY REQUIREMENT**

(1) GOVERNED MOTOR UNIT: This data for Governed Motor Unit used without current limiting resistors in Electrical Service Unit.

- (a) INPUT VOLTAGE: 115 volts  $\pm$  10 percent ac.
- (b) SINGLE PHASE
- (c) FREQUENCY: 50 to 60 cycles.
- (d) INPUT CURRENT
  - STARTING: 1.75 amps.
  - RUNNING: 1 amp.
- (e) POWER FACTOR: 0.83.
- (f) WATTAGE: 95 watts.
- (g) HEAT DISSIPATION: 75 watts.

POWER REQUIREMENTS: 115 v dc.

**MAJOR COMPONENTS**

QTY	ITEM	STOCK NUMBERS	DIMENSIONS (INCHES)	WEIGHT (LBS)
1	Teletypewriter Set			
	AN/FGC-74X includes:			
1	Cabinet Electrical Equip-			
	ment CY-3689/FGC-74			
1	Keyboard-Transmitter,			
	Teletypewriter TT-385/UG			
1	Typing Unit, Teletypewriter			
	TT-386/UG			
1	Motor, Alternating Current			
	PD-97/UG			
1	Motor, Alternating Current			
	PD-18/U			
3	Gear Set-45.5 Baud, Mfr's			
	No. 173795			
3	Gear Set-50 Baud, Mfr's			
	Part No. 163504			
3	Gear Set-75 Baud, Mfr's			
	Part No. 163505			
1	Tuning Fork Mfr's Part			
	No. 104986			

TELETYPEWRITER SET AN/FGC-74X

REFERENCE DATA AND LITERATURE:

NAVSHIPS 94460: Teletype Instruction Manual No. 111MA, for Teletypewriter Set AN/FGC-74  
or 74X.

SHIPPING DATA

PKGS (VOLUME CU FT) WEIGHT(LBS)

PROCUREMENT DATA

PROCURING SERVICE: USN  
SPEC &/OR DWG: 5013BS

DESIGN COG: USN, BuShips

CONTRACTOR	LOCATION	CONTRACT OR ORDER NO.	APPROX. UNIT COST
Teletype Corporation, Mfg's Model No. 28	Skokie, Illinois	N0bsr 87305	



UNCLASSIFIED

NAVSHIPS 93400

ELECTRONIC EQUIPMENT - PRELIMINARY DATA

NAVSHIPS 4457 (Rev. 9-62) (CONT'D)

DESIGNATION	ITEM NAME
AN/FGC-79	Teletypewriter Set

FUNCTIONAL DESCRIPTION: SKETCH, MFG. DIMENSIONS, ETC.

The AN/FGC-79 receives messages electrically from the telegraph channel. It monitors and prints the message on page-size copy paper. It will electrically transmit over the telegraph channel messages originated by keyboard operation. It provides monitoring facilities for three receiving-typing units plus a keyboard with switching facilities to connect any of the three receive-typing units in series. It is a fixed station using a standard communications keyboard and a 7.42 unit code. It prints English characters; 72 characters per line. It operates by friction feed and uses three synchronous-wound motors. The unit is similar to the AN/FGC-79X except that the AN/FGC-79X uses series-governed motors.

No unit cost available.

Source of information: Request for Nomenclature  
 Nomenclature correspondence  
 Contract

CLASSIFICATION
UNCLASSIFIED

7/1/64

CHANGE 73 - 687B/678D

1.5 AN/FGC-79: 2

B-17576



DESIGNATION	ITEM NAME
AN/FGC-79A	Teletypewriter Set

FUNCTIONAL DESCRIPTION: SKETCH, MFG. DIMENSIONS, ETC.

The AN/FGC-79A receives messages electrically from the telegraph channel. It monitors and prints the messages on page-size copy paper. It will electrically transmit over the telegraph channel those messages originated by keyboard operation. It provides monitoring facilities for three receiving-typing units plus a keyboard with switching facilities to connect any of the three receive-typing units in series. It is a fixed station using a standard communications keyboard and a 7.42 unit code. It prints English characters; 72 characters per line. It operates by friction feed and uses three synchronous-wound motors. The AN/FGC-79A is one-way interchangeable with the AN/FGC-79 except that it uses a TT-387/UG keyboard in place of the TT-417/FG keyboard and uses a Mfr's Part No. 164926 Modification Kit. Maintenance parts differ.

No unit cost available.

Source of information: Request for Nomenclature



## ELECTRONIC EQUIPMENT - PRELIMINARY DATA

NAVSHIPS 4457 (Rev. 9-62) (CONT'D)

DESIGNATION	ITEM NAME
AN/FGC-79AX	Teletypewriter Set

FUNCTIONAL DESCRIPTION: SKETCH. MFG. DIMENSIONS, ETC.

The AN/FGC-79AX receives messages from the telegraph channel, monitors the messages, and prints them on page-size copy paper. It transmits messages over the telegraph channel. It provides monitoring facilities for three receive-typing units plus a keyboard with switching facilities to connect any of the three receive-typing units in series. The unit is a fixed station with a standard communications keyboard. It prints English characters; 72 characters per line and a 7.42 unit code. It operates by friction feed and uses three synchronous-wound motors. The AN/FGC-79AX is similar to the AN/FGC-79X except that it uses 50-cycle, synchronous-wound motors instead of 60-cycle, series-governed motors, and it uses a TT-387/UG keyboard instead of the TT-417/UG keyboard. Drive parts and other maintenance parts are different.

No unit cost available.

Source of information: Request for Nomenclature.





UNCLASSIFIED

ELECTRONIC EQUIPMENT - PRELIMINARY DATA  
NAVSHIPS 4457 (Rev. 9-62) (CONT'D)

NAVSHIPS 93400

DESIGNATION

AN/FGC-79X

ITEM NAME

Teletypewriter Set

FUNCTIONAL DESCRIPTION: SKETCH, MFG. DIMENSIONS, ETC.

The AN/FGC-79X receives messages from the telegraph channel, monitors the messages, and prints them on page-size copy paper. It transmits messages over the telegraph channel. It provides monitoring facilities for three receive-typing units plus a keyboard with switching facilities to connect any of the three receive-typing units in series. The unit is a fixed station with a standard communications keyboard. It prints English characters; 72 characters per line and a 7.42 unit code. It operates by friction feed and uses three series-governed motors. The AN/FGC-76X is similar to the AN/FGC-76 except that the AN/FGC-76 uses synchronous motors.

Unit cost:

Source of information: Request for Nomenclature.  
Nomenclature correspondence.  
Contract

167

CLASSIFICATION

UNCLASSIFIED

7/1/64

CHANGE 73 - 687B/678D

1.5 AN/FGC-79X: 2

B-17878



UNCLASSIFIED

NAVSHIPS 93400

**ELECTRONIC EQUIPMENT - PRELIMINARY DATA**

NAVSHIPS 4457 (Rev. 9-62) (CONT'D)

DESIGNATION	ITEM NAME
AN/FGR-5	Teletypewriter Reperforator Set
FUNCTIONAL DESCRIPTION: SKETCH, MFG. DIMENSIONS, ETC.	

The AN/FGR-5 is a fixed-station type, uses English characters, and has a synchronous motor. It is a torn tape relay receiver, similar to TT-331/UG except for the 7.00 unit code, drive parts, and MT-2423/UG instead of MT-2594/UG. The set is used with AN/FGT-4 and AN/FGR-6.

No unit cost available.

Source of information: Request for Nomenclature.



102  
168

CLASSIFICATION  
**UNCLASSIFIED**

Re1 7/1/64

CHANGE 59/73 - 679C - 687B

1.5 AN/FGR-5: 2

B-17678

20 September 1967  
Cog Service: USN

FSN:

REPERFORATOR SET TELETYPEWRITER AN/FGR-5A  
Functional Class:

USA

USN

USAF

TYPE CLASS:

Used by

MANUFACTURER'S NAME/CODE NUMBER: Teletype Corporation (59433).

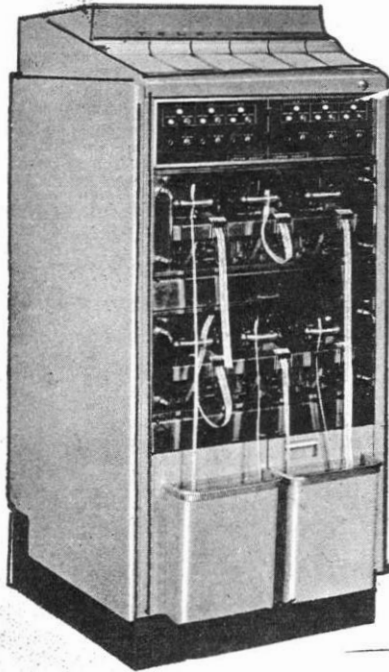

REPERFORATOR SET TELETYPEWRITER AN/FGR-5A

**FUNCTIONAL DESCRIPTION:**

The Reperforator Set Teletypewriter AN/FGR-5A is a torn tape relay receiver. The equipment consists of a cabinet which houses two 3-gang printing tape punches (a total of 6 punches powered by 2 motors). These punches receive incoming electrical pulses and punch corresponding tapes. Simultaneously, they print the contents of the messages on the tapes.

No field changes in effect at time of preparation (8 May 1967).

**RELATION TO OTHER EQUIPMENT:** None.

**EQUIPMENT REQUIRED BUT NOT SUPPLIED:** None.

1.5 AN/FGR-5A: 1

---

REPERFORATOR SET TELETYPEWRITER AN/FGR-5A

---

**TECHNICAL CHARACTERISTICS:**

OPERATION: Fixed Station.  
CHARACTERS: English.  
MOTOR: Synchronous.  
SPEED: 65, 75 or 100 rpm.  
TAPE SUPPLY REEL CAPACITY: 1000 ft.  
TAPE WIDTH: 11/16 in.  
UNIT CODE: 7.00.  
POWER REQUIREMENTS: 115 vac. 60 cycles, (or 50 to 60 cps),\*\* 115 v dc, single-phase.

\*\*Special Governed Motors are Supplied where necessary.

**MAJOR COMPONENTS**

QTY	ITEM	DIMENSIONS (INCHES)	WEIGHT (LBS)
1	Reperforator Set Teletypewriter AN/FGR-5A includes:		
1	Cabinet Electrical Equipment: CY-3698/UG		
2	Teletypewriter Base Unit: MT-2423/UG		
6	Teletypewriter Reperforator: TT-315/UG		
2	Alternating Current Motor: PD-67/U		
2	Gear Set-45.5 Baud Mfr's Part No. 173584		
2	Gear Set-50 Baud Mfr's Part No. 164335		
1	End Enclosure Mfr's Part No. 161999 BR.		

**REFERENCE DATA AND LITERATURE:**

Teletype Corporation Technical Manual for the Torn Tape Receiver, Model No. 28.

**SHIPPING DATA**

PKGS	VOLUME (CU FT)	WEIGHT (LBS)
------	----------------	--------------

**PROCUREMENT DATA**

PROCURING SERVICE: USN  
SPEC &/OR DWG: DESIGN COG: USN, NavShips

CONTRACTOR	LOCATION	CONTRACT OR ORDER NO.	APPROX. UNIT COST
Teletype Corporation Model No. 28	Skokie, Illinois	N0bsr-87325 Mod-1	



UNCLASSIFIED  
ELECTRONIC EQUIPMENT - PRELIMINARY DATA  
NAVSHIPS 4457 (Rev. 9-62) (CONT'D)

NAVSHIPS 93400

DESIGNATION	ITEM NAME
AN/FGR-6	Teletypewriter Reperforator Set
FUNCTIONAL DESCRIPTION: SKETCH. MFG. DIMENSIONS. ETC.	

The AN/FGR-6 is a fixed-station unit with English characters and a synchronous motor. It is a torn tape relay monitor, similar to TT-332/UG except for the 7.00 unit code, drive parts, and MT-2423/UG instead of MT-2594/UG. The set is used with AN/FGR-5 and AN/FGT-4.

No unit cost available.

Source of information: Request for Nomenclature.

173

CLASSIFICATION  
UNCLASSIFIED

Rei 7/1/64

CHANGE 59/73 - 694D/687B

1.5 AN/FGR-6: 2

B-17878





UNCLASSIFIED

**ELECTRONIC EQUIPMENT - PRELIMINARY DATA**  
**NAVSHIPS 4457 (Rev. 9-62) (CONT'D)**

NAVSHIPS 93400

DESIGNATION	ITEM NAME
AN/FGR-6A	Teletypewriter Reperator Set

FUNCTIONAL DESCRIPTION: SKETCH, MFG. DIMENSIONS, ETC.

The AN/FGR-6A is mechanically and electrically interchangeable with AN/FGR-6 except that it is housed in cabinet CY-3699/UG instead of CY-3250/UG. Maintenance parts differ.

Unit cost: \$5,326.70

Source of information: Request for Nomenclature.  
Contract

162

175



**ELECTRONIC EQUIPMENT - PRELIMINARY DATA**  
**NAVSHIPS 4457 (Rev. 9-62) (CONT'D)**

DESIGNATION	ITEM NAME
AN/FGT-4	Teletypewriter Distributor-Transmitter Set

FUNCTIONAL DESCRIPTION: SKETCH, MFG. DIMENSIONS, ETC.

The AN/FGT-4 is a fixed-station unit using English characters and a synchronous motor. It is a torn tape relay transmitter similar to TT-333/UG except for the 7.00 unit code, drive parts, and T-D Unit TT-354/FG (SR-2510) instead of TT-334/UG. The set is used with SR-2507 and SR-2508.

No unit cost available.

Source of information: Request for Nomenclature.

3 May 1966

ANTENNA COUPLER GROUP AN/FRA-49(V)

Cog Service: USN FSN:

Functional Class:

USA

USN

USAF

TYPE CLASS:

Used by

MANUFACTURER'S NAME/CODE NUMBER: Electronic Communication Incorporated, (00724).

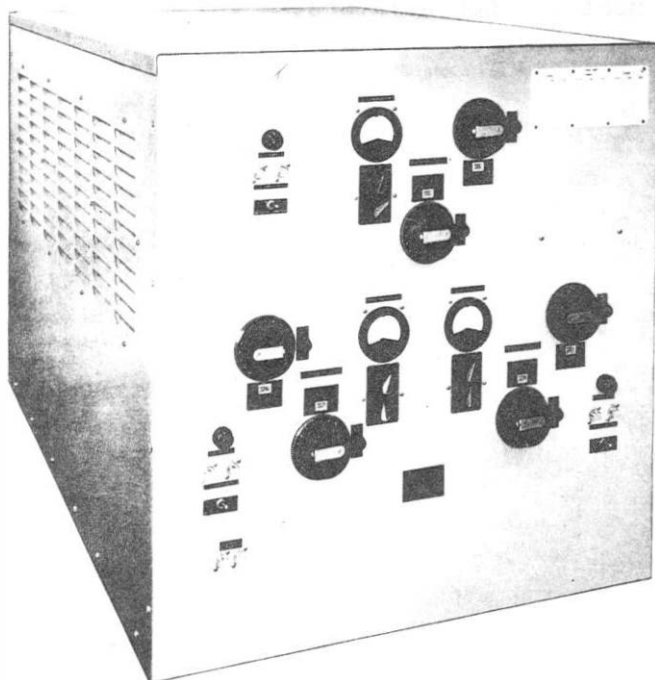

ANTENNA COUPLER GROUP AN/FRA-49(V)

**FUNCTIONAL DESCRIPTION:**

The Antenna Coupler Group AN/FRA-49(V) is designed for use at U.S. Navy Shore Stations and is not to be exposed to the weather. The equipment is designed for operation in the temperature range of zero to 50 deg C into an antenna that presents an impedance variation of three to one or less over the frequency range which is determined by the particular Antenna Coupler's in this equipment cabinet.

No field changes in effect at time of preparation (10 February 1966).

**RELATION TO OTHER EQUIPMENT:**

The AN/FRA-49(V) is mechanically interchangeable with Antenna Couplers CU-998/FRA-49(V) and CU-999/FRA-49(V).

1.1 AN/FRA-49(V): 1

---

**ANTENNA COUPLER GROUP AN/FRA-49(V)**

---

**EQUIPMENT REQUIRED BUT NOT SUPPLIED:**

(3) Cables RG-358/U or RG-164/U.

**TECHNICAL CHARACTERISTICS:**

PRIMARY POWER INPUT: 115 v ac, 50 to 60 cps  $\pm$  10%, 108 watts.

FREQUENCY RANGE: 6 to 10 mc or 5 to 15 mc (over-all).

ANTENNA COUPLER CU-998/FRA-49(V): 2 mc to 6 mc.

ANTENNA COUPLER CU-999/FRA-49(V): 5 mc to 15 mc.

TRANSMISSION EFFICIENCY

(1) ANTENNA COUPLER CU-998/FRA-49(V): 78 percent.

(2) ANTENNA COUPLER CU-999/FRA-49(V): 75 percent.

INPUT IMPEDANCE: 75 ohms.

OUTPUT IMPEDANCE: 75 ohms.

ANTENNA IMPEDANCE: 3 to 1 or less variation.

MAXIMUM INPUT POWER (RF) (PER CHANNEL): Three kw carrier level, 100 percent AM DSB or 10 kw peak envelope power SSB.

CHANNEL SEPARATION (MIN. FREQUENCY SEPARATION BETWEEN TWO CHANNELS): 10 percent of lower channel.

ADJACENT CHANNEL ATTENUATION: 27 db.

TEMPERATURE RANGE: 0 deg C to 50 deg C (32 deg F to 122 deg F).

**MAJOR COMPONENTS**

179

QTY	ITEM	STOCK NUMBERS	DIMENSIONS (INCHES)	WEIGHT (LBS)
1	Antenna Coupler Group AN/FRA-49(V) includes:		36-3/16 x 39-1/2 x 62-1/2	630
1	Antenna Coupler CU-998/FRA-49(V)			
1	Antenna Coupler CU-999/FRA-49(V)			
1	Electrical Equipment Cabinet, CY-3409/FRA-49(V)			
1	Connector MS-3108B18-5S			
3	Connector MS-3106A14S-2S			
3	Connector UG-154/U			
1	Connector Part No. 11 (Special Part)			

**REFERENCE DATA AND LITERATURE:**

NAVSHIPS 94253: Technical Manual for Antenna Coupler Group AN/FRA-49(V).

---

ANTENNA COUPLER GROUP AN/FRA-49(V)

---

SHIPPING DATA

PKGS	VOLUME (CU FT)	WEIGHT(LBS)
1	14	190
1	14	190
1	14	190
1	18	118
1	64	568

PROCUREMENT DATA

PROCURING SERVICE: USN  
SPEC &/OR DWG: A-3700 SHIPS

DESIGN COG: USN, BuShips

CONTRACTOR	LOCATION	CONTRACT OR ORDER NO.	APPROX. UNIT COST
Electronic Communication Incorporated	St. Petersburg, Florida	N0bsr 85264	

24 July 1967  
Cog Service: USN

FSM:

ANTENNA SET AN/FRA-109  
Functional Class:

USA

USM

USAF

TYPE CLASS:

Used by

MANUFACTURER'S NAME/CODE NUMBER: Granger Associates (08935).

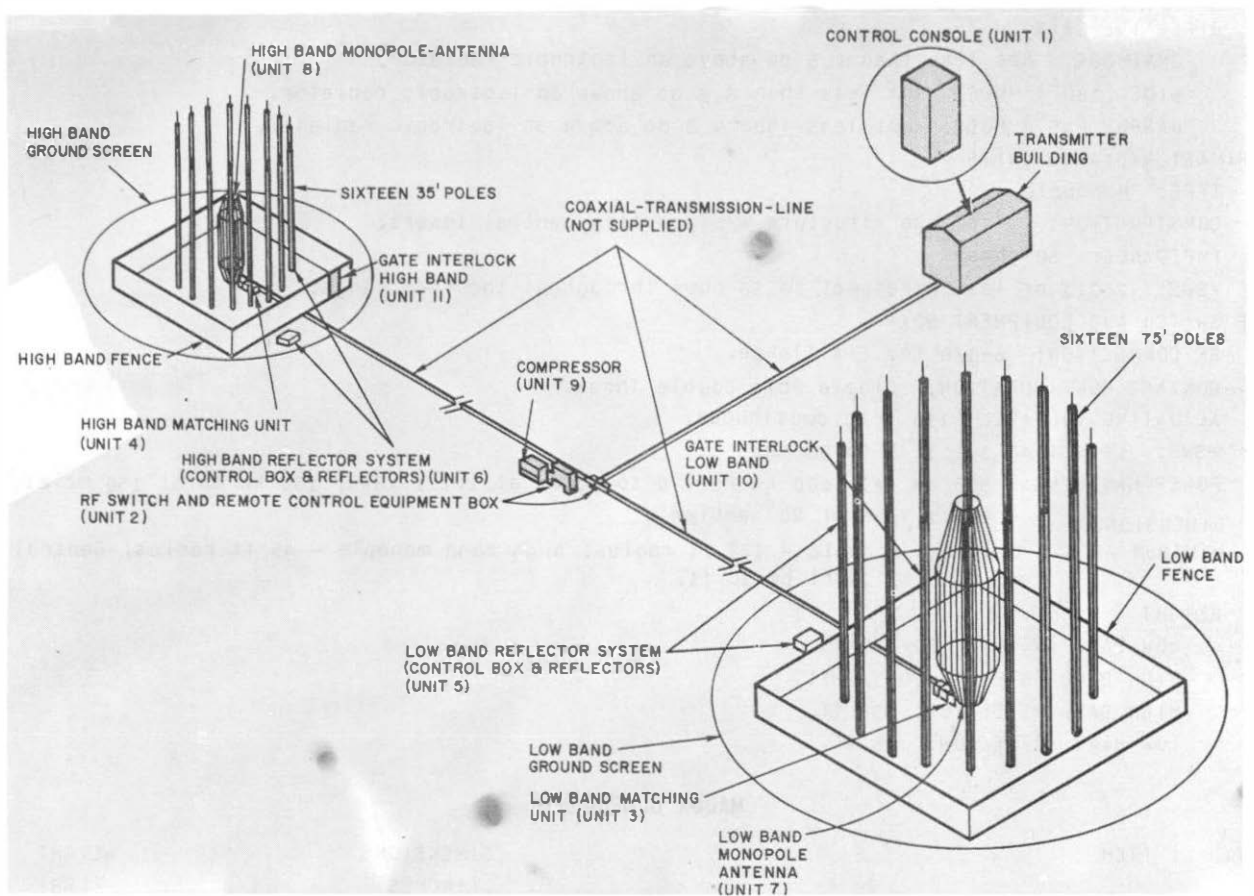

ANTENNA SET AN/FRA-109



---

**ANTENNA SET AN/FRA-109**

---

**FUNCTIONAL DESCRIPTION:**

Antenna Set AN/FRA-109 is an omnidirectional high power high frequency transmitting antenna. It is capable of handling input power of 300 kw average and 1200 kilowatts instantaneous peak through the frequency range of 4 to 30 megacycles. The operator may select the direction and beam width of the transmitted signal or may select omnidirectional radiation.

No field changes in effect at time of preparation (25 April 1967).

**RELATION TO OTHER EQUIPMENT:**

The AN/FRA-109 is similar to the AN/FRA-107, except for the use of pneumatically activated switches, and other design changes.

**EQUIPMENT REQUIRED BUT NOT SUPPLIED:**

- (1) Coaxial Transmission Line, 350 ft.

**TECHNICAL CHARACTERISTICS:**

POWER REQUIREMENTS: 120 v ac, and 240 to 480 v ac  $\pm 10\%$ , 1 ph, 50 to 60 cps, 1.8 kva.

FREQUENCY RANGE: 4 to 30 mc in 2 bands, 4 to 11 mc, and 11 to 30 mc.

POWER HANDLING CAPACITY: 600 kw peak envelope power, 300 kw avg pwr.

**OUTPUT SIGNAL CHARACTERISTICS**

**DIRECTIVE GAIN**

OMNIMODE: Not less than 4.5 db above an isotropic radiator.

WIDE (180°) MODE: Not less than 5.5 db above an isotropic radiator.

NARROW (45°) MODE: Not less than 9.5 db above an isotropic radiator.

**PRIMARY RADIATOR UNITS**

TYPE: Monopole.

CONSTRUCTION: wire cage structure w/supporting central towers.

IMPEDANCE: 50 ohms.

VSWR: 2.0:1 or less w/respect to 50 ohms throughout the freq range.

**RF SWITCH AND EQUIPMENT BOX**

RF CONNECTION: 6-1/8 in. EIA flange.

CONTACT CONFIGURATION: Single Pole Double Throw.

ACTUATING VOLTAGE: 115 v ac continuous.

VSWR: Less than 1.1:1, 0 to 30 mc.

POWER HANDLING: 325 kw cw; (600 kw PEP) 0 to 30 mc at 1.1:1 VSWR; 150 kw cw at 150 mc at

1.1:1 VSWR at 40° ambient.

**DIMENSIONS**

MINIMUM AREA: Low band monopole - 123 ft radius; high band monopole - 45 ft radius; Control equipment, 10 ft by 10 ft.

**HEIGHT**

LOW BAND ANTENNA: 52-1/2 ft.

HIGH BAND ANTENNA: 20-1/2 ft.

HIGH BAND REFLECTOR: 30 ft.

LOW BAND REFLECTOR: 75 ft.

**MAJOR COMPONENTS**

QTY	ITEM	DIMENSIONS (INCHES)	WEIGHT (LBS)
1	Antenna Set AN/FRA-109		

1.1 AN/FRA-109: 2

---

ANTENNA SET AN/FRA-109

---

**REFERENCE DATA AND LITERATURE:**

Instruction Manual and Maintenance Standards Book for Antenna Set AN/FRA-109.

**SHIPPING DATA**

PKGS

VOLUME (CU FT)

WEIGHT (LBS)

**PROCUREMENT DATA**

PROCURING SERVICE: USN  
SPEC &/OR DWG:

DESIGN COG: USN, NAVSHIPS

<b>CONTRACTOR</b>	<b>LOCATION</b>	<b>CONTRACT OR ORDER NO.</b>	<b>APPROX. UNIT COST</b>
Granger Associates	Palo Alto, Calif.	N600(63133)65709	