

## CHAPTER 8

# ANTENNAS AND RADIO WAVE PROPAGATION

The transmission of radio waves through space is known as wave propagation. A study of antennas and wave propagation is essential to an understanding of radio communication.

In any radio system, energy in the form of electromagnetic (radio) waves is generated by a transmitter and is fed to an antenna by means of a transmission line. The antenna radiates this energy out into space at the speed of light (approximately 186,000 miles per second). Receiving antennas, placed in the path of the traveling radio wave, absorb part of the radiated energy and send it through a transmission line to a receiver. Thus, the components required for successful transmission of intelligence by means of radio waves are a transmitter, a transmission line, a transmitting antenna, a medium through which the waves travel (for example, the atmosphere surrounding the earth), a receiving antenna, another transmission line, and the receiving equipment. Figure 8-1 is a block diagram showing the arrangement of these components.

Successful communication by means of radio waves depends chiefly on the power of the transmitter, the distance between the transmitter and receiver, and the sensitivity (ability to amplify weak signals) of the receiver. The ability of the earth's atmosphere to conduct the energy to its destination, together with the nature of the terrain between the sending and the receiving points, may, however, be responsible for the frequency selected. Interfering signals can make reception impossible at a desired time. Also, the amount of noise present and transmission line losses may combine to make an otherwise good signal unintelligible. To understand the proper importance of all these factors, it first is necessary to investigate the nature of the radio wave and the conditions affecting its successful propagation.

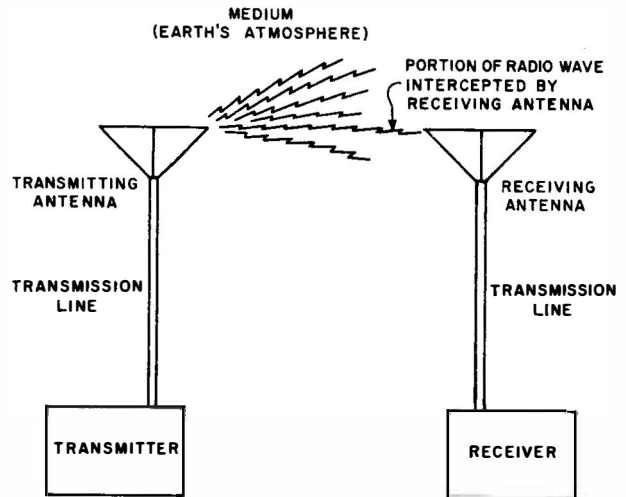

31.6

Figure 8-1. —Simple radio communication network.

### RADIO WAVE

Any wire or other conductor carrying alternating current produces electromagnetic fields that move outward into surrounding space. As the current increases and decreases, the electromagnetic field alternately grows and collapses about the wire. When the speed of these alternations is increased above a certain point, the collapsing electromagnetic field does not have time to get back to the wire before the next alternation begins. Hence, some of the electromagnetic energy is disengaged from the wire and set free in space. The radiated electromagnetic energy, known as the radio wave, moves in free space at the speed of light. (The speed of light is 300,000,000 meters, or about 186,000 miles, a second.) It travels almost—but not quite—that fast in air. Regardless of

the frequency of alternation, the velocity of the radio wave is constant.

It is believed that radio waves travel in a series of crests and troughs, similar to ocean waves or round, outward-moving waves created by dropping a stone on the smooth surface of a pond. Although the analogy is not exact, it serves a useful purpose because it makes comparison with a well-known physical action. The movement of radio waves is somewhat like the movement of water waves away from a point of disturbance.

Figure 8-2 shows how a falling stone imparts wave motion to a water surface. The action illustrated fails to compare with that of electromagnetic radiation in that a continuous wave motion is not imparted to the surface of the water by a dropped stone. A study of figure 8-2 should aid in understanding four important aspects of the radio wave: **AMPLITUDE**, **CYCLE**, **FREQUENCY**, and **WAVELENGTH**.

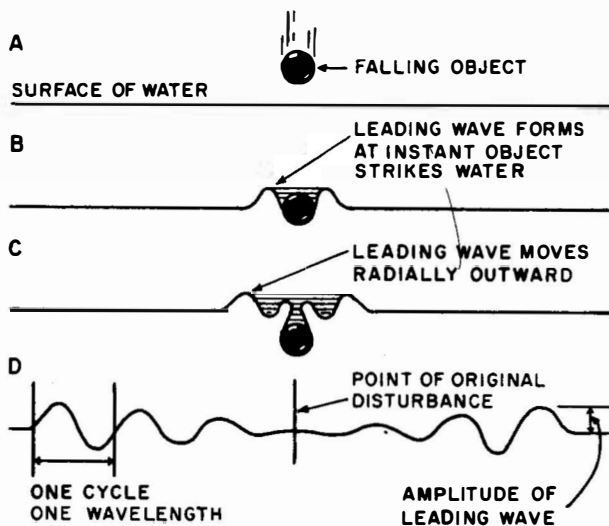

Figure 8-2. —How a falling stone imparts wave motion to a water surface. 31.7

The amplitude of the wave in part D of figure 8-2 is the distance from the average water level to the peak (or trough) of the wave. In other words, the amplitude is the measure of the energy level of the wave. This is the concept in which amplitude is applied to a radio wave—as the measure of energy level.

A cycle is a complete sequence of variation of movement of the wave, and usually is represented graphically from a point at the average level through a crest and a trough and back again to the corresponding average level. Thus,

with the average level as the reference point, each cycle is made up of two reversals. In a complete cycle the wave moves first in one direction, then in the other, and then returns to the first direction to begin the next cycle (fig. 8-2, part D).

The frequency of a wave is the number of cycles that occur in 1 second. Unlike the wave illustrated, which would have a very low frequency, radio waves may have frequencies of a few thousand cycles per second, or many million cycles per second. They become so large, numerically, that it is more convenient to use a larger unit than the cycle. For this reason, radiofrequencies are counted in thousands, millions, billions, and trillions of cycles, using four prefixes from the metric system: **KILO**, **MEGA**, **GIGA**, and **TERA**. The latter two, giga and tera, as yet have limited application in naval communications, but you are required to know them. The kilocycle is 1 thousand cycles and is abbreviated kc; the megacycle is 1 million cycles (or 1000 kc) and is abbreviated mc; the gigacycle is 1 billion cycles (or 1000 mc) and is abbreviated gc; and the teracycle is 1 trillion cycles (or 1000 gc) and is abbreviated tc. A frequency of 15,000 cycles per second, for example, is expressed as 15 kc. By the same token, 500,000 cycles is expressed as 500 kc. When the number of kilocycles becomes too large, megacycles are used instead to simplify the figure. Thus, 82,000 kc is expressed as 82 mc, and so on.

The characteristics of low-frequency propagation are different from those of high-frequency propagation. Hence, for ease of identification, the frequencies usually are classed in bands, as in table 8-1.

Table 8-1. — Frequency Bands

Description	Abbreviation	Frequency
Very low	VLF	Below 30 kc
Low	LF	30 to 300 kc
Medium	MF	300 to 3000 kc
High	HF	3 to 30 mc
Very high	VHF	30 to 300 mc
Ultrahigh	UHF	300 to 3000 mc
Superhigh	SHF	3 to 30 gc
Extremely high	EHF	30 to 300 gc

The choice of a given frequency as the point of division between bands, such as between the very high frequencies and the ultrahigh frequencies, is more or less arbitrary and is agreed upon for convenience.

A wavelength is the space occupied by a cycle, and may be measured from crest to crest, trough to trough, or from any point to the next corresponding point. The wavelength of a radio frequency may vary from several miles to a fraction of an inch. In actual practice, though, radio wavelength usually is measured in meters instead of feet and inches. (A meter is 39.37 inches.)

Finding the wavelength of any frequency is a relatively simple process. We know that a radio wave travels at a constant speed of 300,000,000 meters (or 186,000 miles) per second. From this, we can determine the length of 1 cycle (wavelength) simply by dividing the velocity of the wave by the frequency of the wave. The foregoing statement is condensed into the following formulas.

1. If the frequency is expressed in cycles per second, use either a or b.

a. Wavelength (in meters)

$$= \frac{300,000,000}{\text{Frequency (in cycles)}}$$

b. Wavelength (in feet)

$$= \frac{984,000,000}{\text{Frequency (in cycles)}}$$

2. When the frequency is expressed in kilocycles, the formulas become either of these:

a. Wavelength (in meters)

$$= \frac{300,000}{\text{Frequency (in kc)}}$$

b. Wavelength (in feet)

$$= \frac{984,000}{\text{Frequency (in kc)}}$$

3. If the frequency is expressed in megacycles, the formulas become one of the following:

a. Wavelength (in meters)

$$= \frac{300}{\text{Frequency (in mc)}}$$

b. Wavelength (in feet)

$$= \frac{984}{\text{Frequency (in mc)}}$$

**RADIATION**

When radio frequency current flows through a transmitting antenna, radio waves are radiated from the antenna in all directions in much

the same way that waves travel on the surface of a pond into which a rock is thrown. As the waves travel outward from the point of origin, they increase in circumference until the field of radiation is so large that a portion of any wave appears to be a straight line or a plane surface.

In considering the radio signal path from a transmitting to a receiving antenna, the concept of a moving wave becomes important. The moving wave actually consists of moving electric and magnetic fields. The moving electric field always creates a magnetic field, and a moving magnetic field creates an electric field. The lines of force of both fields are always at right angles to each other and perpendicular to the direction of travel through space.

Figure 8-3 shows the components of the radio wave. From the point of view of the observer, the wave marches past, varying in direction and magnitude as in the picture. Imagine that the entire wave is moving at a constant speed in the direction indicated. The intensities of both the electric and the magnetic fields are maximum at the same instant the crest of the wave passes the antenna. Conversely, the intensities of both fields are minimum at the same instant the zero point is reached. At all times, however, the fields are perpendicular to each other.

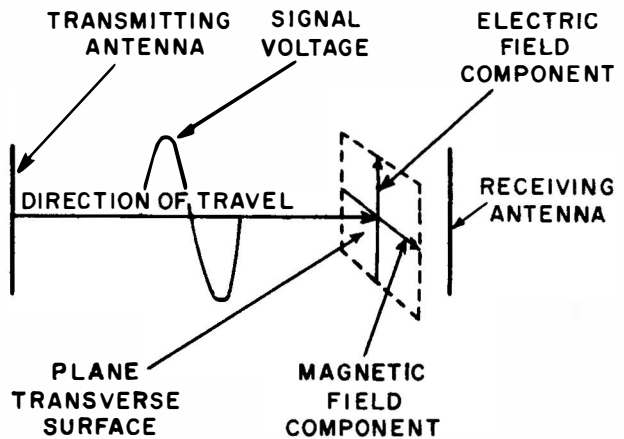

31.8

Figure 8-3. —Components of radio wave.

Figure 8-4 illustrates the instantaneous cross section of a radio wave moving in a direction away from the reader. The electric lines of force are perpendicular to the earth, whereas the magnetic lines are horizontal. A change in direction of either the electric or magnetic lines would result in a change in direction of travel of the wave.

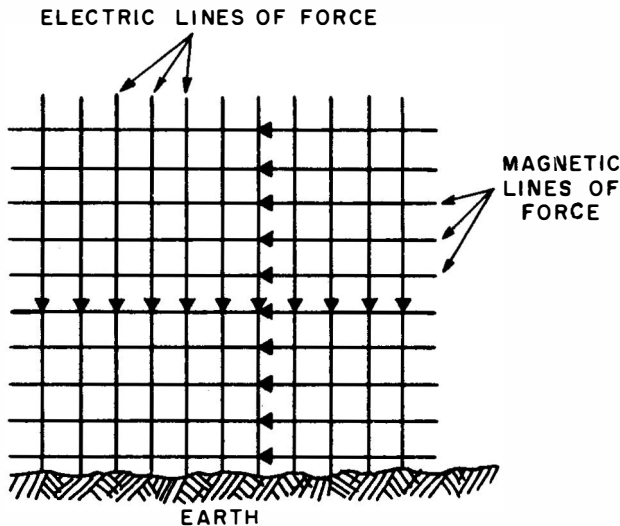

Figure 8-4.—Instantaneous cross section of a radio wave. 20.241

## POLARIZATION

The lines of force of the electric field are propagated perpendicular to the earth when the transmitting antenna is oriented perpendicular to the earth. In this instance, the radio wave is said to be polarized vertically. If the transmitting antenna is horizontal, the electric lines of force will be horizontal, and the wave is then said to be polarized horizontally. Actually, the polarization of the wave may be altered somewhat during travel. But the electric and magnetic lines of force are always perpendicular to each other and to the direction of travel, regardless of polarization.

The polarization of the wave is an important consideration in the efficient transmission and reception of radio signals. Thus, if a single-wire antenna is used to extract energy from a passing radio wave, maximum pickup results when the antenna is so placed physically that it lies in the same direction as the electric field component. For this reason, a vertical antenna (one perpendicular to the ground) should be used for the efficient reception of vertically polarized waves (those transmitted from a vertical antenna). Also, a horizontal antenna should be used for the reception of horizontally polarized waves (those transmitted from a horizontal antenna). In both instances, it is assumed that the wave is traveling parallel to the earth's surface from the transmitting to the receiving antennas. Such a condition does not al-

ways prevail, however, as we shall see when we consider the effects of the atmosphere on the behavior of radio waves.

## RADIO WAVE PROPAGATION

The study of radio wave propagation is concerned chiefly with the properties and effects of the medium through which radio waves must travel in their journey between transmitting and receiving antennas. Because the atmosphere is the common medium for the propagation of radio waves, it is discussed here in some detail.

## ATMOSPHERE

The atmosphere about the earth is not uniform. It changes with a change in height or geographical location, or even with a change of time (day, night, season, year). To assist us in understanding the effect these changes have on radio waves, the various layers of the atmosphere have been distinguished. These layers are the troposphere, the stratosphere, and the ionosphere. Their relative positions are seen in figure 8-5.

The troposphere is the portion of the earth's atmosphere extending from the surface of the earth to heights of about 6 1/2 miles. The temperature in this region varies appreciably with altitude.

The stratosphere lies between the troposphere and the ionosphere. It extends from about 6 1/2 miles to approximately 30 miles above the surface of the earth. The temperature in this region is almost constant.

Besides the usual variations in moisture content and temperature, and the variations in density associated with a change in elevation, the atmosphere is distinguished mainly by the variation in amount of ionization present. The ionization is believed to result from ultraviolet radiation from the sun and is explained in greater detail later, when we discuss the ionosphere as a separate topic. For the present, it is enough to know that the ionosphere is that portion of the earth's atmosphere above the lowest level at which ionization affects the transmission of radio waves. The ionization of this layer is large compared with that near the surface of the earth. It extends from about 30 miles to 250 miles above the earth. The ionosphere itself is composed of several layers (fig.

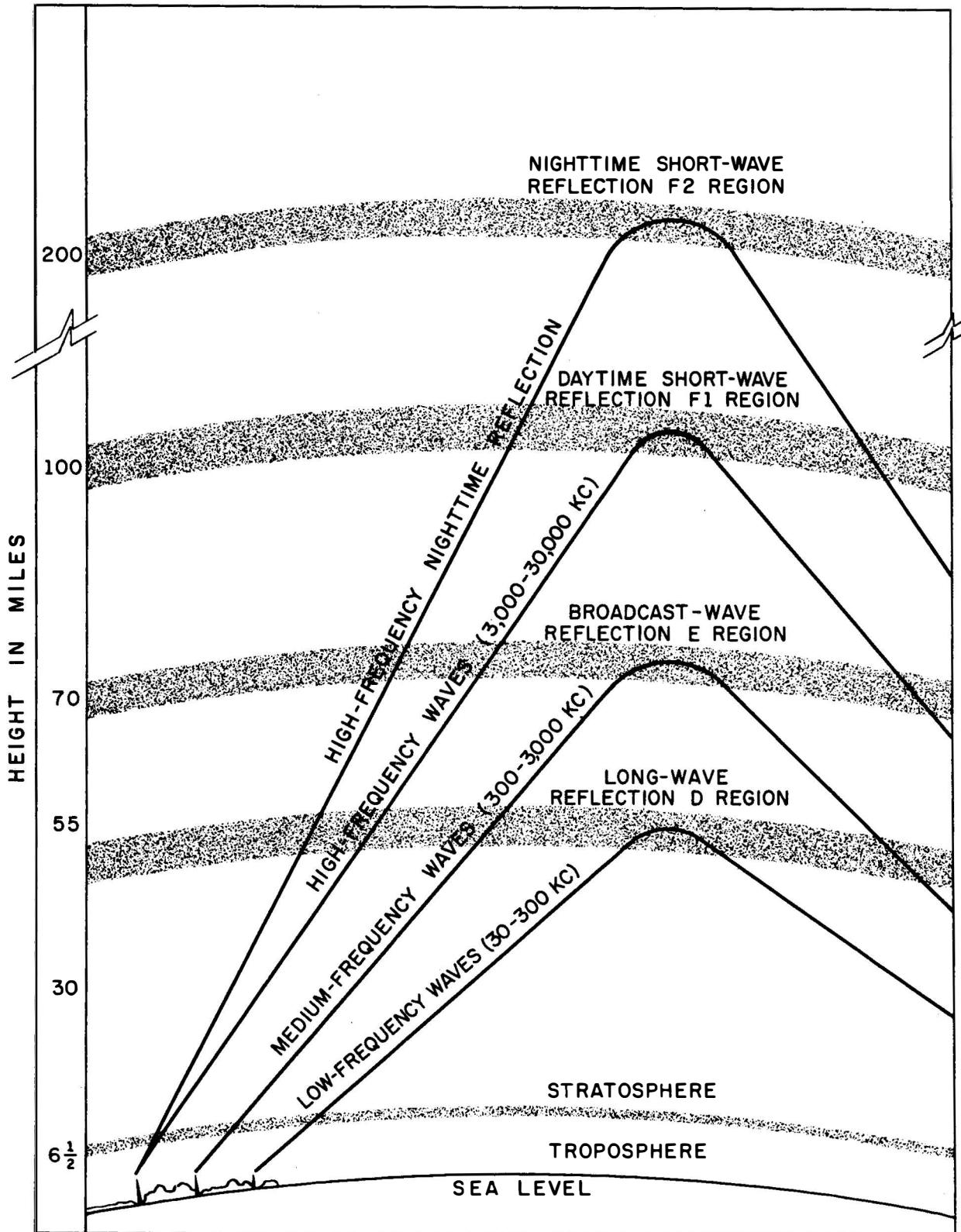

31.9

Figure 8-5. —Layers of the earth's atmosphere.

8-5), where ionization occurs at different levels and intensities.

### PROPAGATION IN THE ATMOSPHERE

Radio waves travel in two principal ways from a transmitter to a receiver: by means of groundwaves, which pass directly from the transmitter to the receiver; or by skywaves, which travel up to the electrically conducting layers of the atmosphere (ionosphere) and are reflected by them back to earth. Long-distance radio transmission takes place chiefly by skywaves. But short-distance transmission and all ultrahigh-frequency transmission occur by means of groundwaves. Some forms of transmission consist of combinations of both.

Like other forms of electromagnetic radiation (such as light), radio waves can be reflected, refracted, and diffracted. The propagation of the groundwave is affected partially by the electrical characteristics of the earth (soil or sea) and by diffraction, or bending, of the wave with the curvature of the earth. These characteristics vary in different localities, but under most conditions they are practically constant with time. Skywave propagation, on the other hand, is variable, because the state of the ionosphere is always changing, and this consequently affects the reflection or the refraction of the waves.

#### Reflection

The reflection of a radio wave is like that of any other type of wave. For instance, when a beam of light falls on the surface of a mirror, nearly all of it is turned back or reflected. (See fig. 8-6.) As with light waves, the efficiency of reflection depends on the reflecting material. Large, smooth metal surfaces of good electrical conductivity (such as copper) are efficient reflectors of radio waves. The surface of the earth itself is a fairly good reflector, and the ionosphere, even though it is not a surface such as a mirror, is also a good reflector of radio waves.

#### Refraction

If a beam of light shines on a smooth surface of water, some of the light is reflected and the remainder penetrates the water, as diagramed in figure 8-6. The phenomenon by which light waves penetrate the water in the manner shown

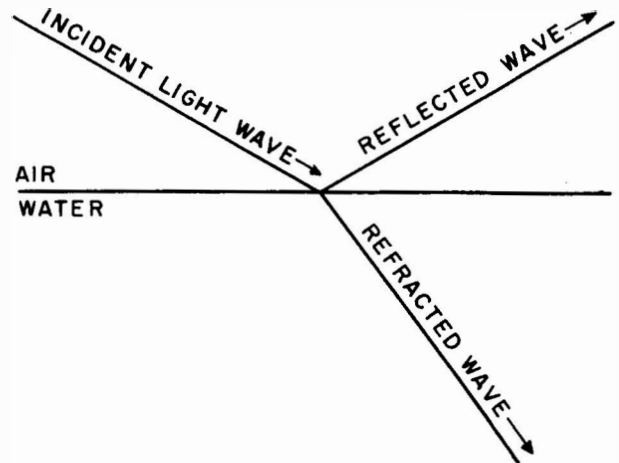

31.1D

Figure 8-6. —Reflection and refraction of a light beam.

is called refraction, and can be observed readily by examining a glass of water into which a spoon is immersed. If viewed from an angle, the spoon appears broken or bent at the point where it enters the surface of the water. The reason for this is that the light waves travel at a slower speed through water than through air. Thus, the direction of travel of the refracted light is different from that of the light beam striking the surface of the water. Radio waves are refracted similarly when passing from one medium to another.

#### Diffraction

If a beam of light in an otherwise blacked-out room shines on the edge of an opaque screen, it can be observed that the screen does not cast a perfectly outlined shadow. The edges of the shadow are not outlined sharply because the light rays are bent around the edge of the object and decrease the area of total shadow. This diffraction or bending of a light wave around the edge of a solid object is slight. The lower the frequency of the wave, or the longer the wavelength, the greater the bending of the wave. Thus, radio waves are diffracted more readily than light waves, and sound waves more so than radio waves. Figure 8-7 illustrates this phenomenon and helps to explain why radio waves of the proper frequency can be received on the far side of a hill, and why sound waves can be heard readily from around the corner of a large building. In the propagation of radio waves at a distance, diffraction is an important

consideration because the largest object to be contended with is the bulge of the earth itself, which prevents a direct passage of the wave from the transmitter to the receiver.

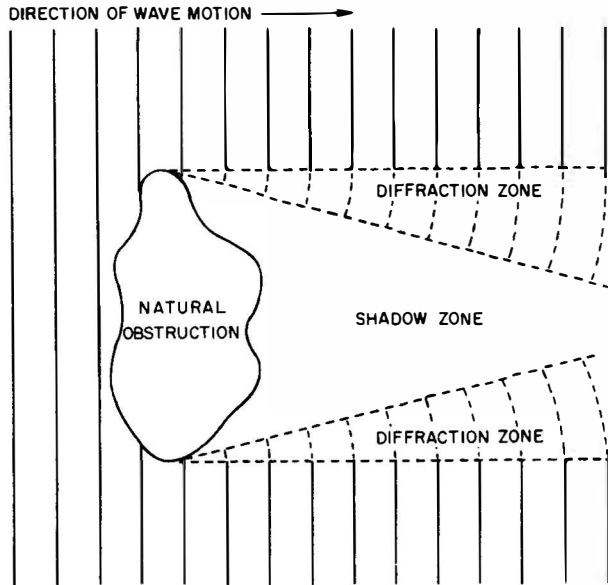

Figure 8-7. — Diffraction of waves around solid object. 31.11

### GROUNDWAVE

Because groundwave radiotransmission does not make use of reflections from the ionosphere, the field intensity of groundwaves depends on other factors. They include the following: (1) transmitter power, (2) frequency of the waves, (3) diffraction of the waves around the curvature of the earth, (4) electrical conductivity of the local terrain, (5) nature of the transmission path, and (6) weather conditions, such as the distribution of the water vapor content of the atmosphere. Moreover, the earth itself is a semiconductor and, upon contact with its surface, some of the energy of the radiated wave is absorbed and rapidly wasted in the form of heat. Sometimes the losses suffered by ground-wave transmission are excessive. For this reason, its use ordinarily is limited to moderate-distance communication (up to several hundred miles).

Figure 8-8 shows how groundwaves take a direct or reflected course from the transmitter to the receiver. They also may be conducted by the surface of the earth, or may be reflected in the troposphere. Accordingly, the resulting groundwave can be considered as composed of

one or more of the following components: the direct wave, the ground-reflected wave, the surface wave, and the tropospheric wave.

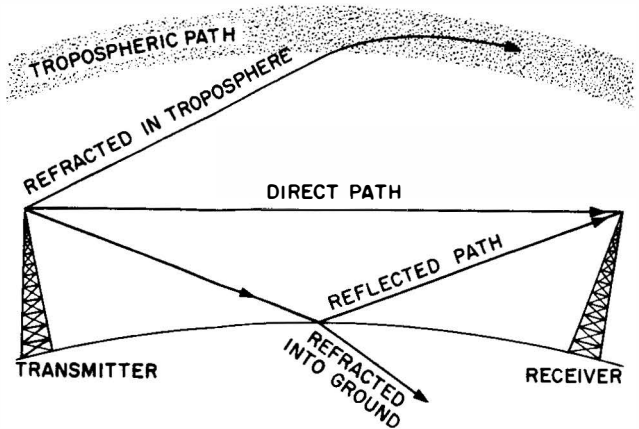

Figure 8-8. — Possible routes for groundwaves. 31.12

### Direct Wave

The direct wave is that part of the entire wave that travels directly from the transmitting antenna to the receiving antenna. This component of the groundwave thus is limited only by the distance to the horizon (or line of sight) from the transmitter, plus the small distance added by the atmospheric diffraction of the wave around the curvature of the earth. The distance can be extended by increasing the height of either the transmitting or receiving antenna, effectively extending the horizon. The direct wave is not affected by the ground or by the earth's surface, but is subject to refraction in the tropospheric air between the transmitter and receiver. Refraction becomes particularly important at very high frequencies.

### Ground-Reflected Wave

The ground-reflected wave, as its name indicates, is the part of the radiated wave that reaches the receiving antenna after it is reflected from the ground or from the sea. Upon reflection from the earth's surface, the reflected wave undergoes a phase reversal of  $180^\circ$  (fig. 8-9). This phase is important in determining the effect of its combining with the direct wave upon arrival at the point of reception. Because the reflected wave travels a longer time in reaching its destination, a phase displacement over and above the  $180^\circ$  shift caused by reflection results. In figure 8-9 it

may be seen that the waves start out with fronts of equal phase, continuing in phase up to the point of reflection of the ground component. Beyond this point, corresponding waves are 180° out of phase, plus whatever small phase displacement results from the relatively longer path of the reflected wave. Thus, the reflected wave arrives at the receiving antenna nearly 180° out of phase with the direct wave, and an undesirable cancellation of signal energy results.

**Surface Wave**

The surface wave is that part of the ground-wave that is affected chiefly by the conductivity of the earth and is able to follow the curvature of the earth's surface. The surface wave is not confined to the earth's surface, however. It extends to considerable heights, diminishing in strength with increased height. Because part

of its energy is absorbed by the ground, the intensity of the surface wave is attenuated (weakened) in its travel. The amount of attenuation depends on the relative conductivity of the earth's surface. Table 8-2 gives the relative conductivity for various types of surface.

Table 8-2. — Surface Conductivity

Type of surface	Relative conductivity
Sea water	Good
Large bodies of fresh water	Fair
Wet soil	Fair
Flat, loamy soil	Fair
Dry, rocky terrain	Poor
Desert	Poor
Jungle	Unusable

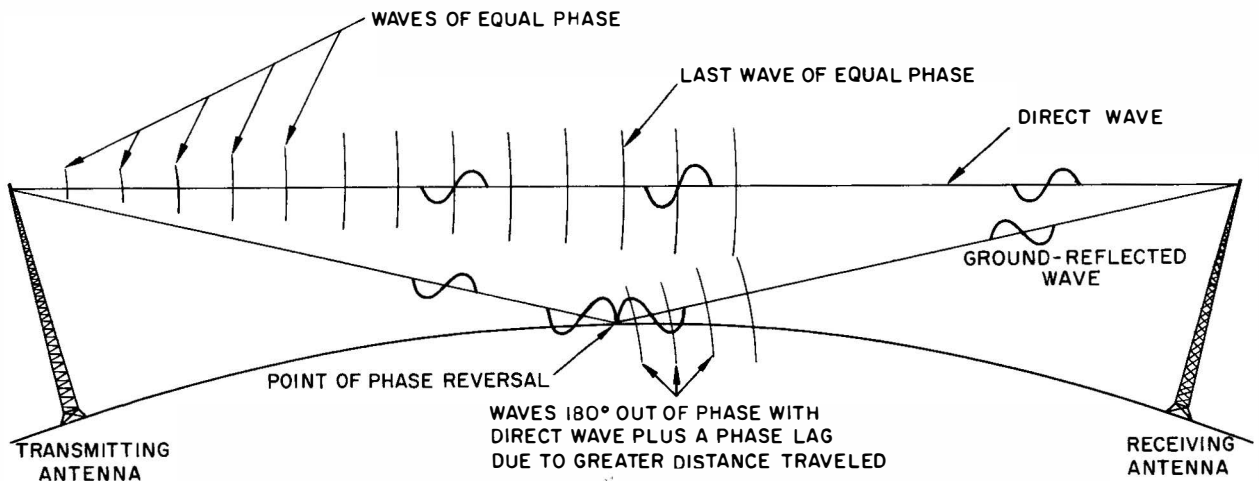

31.13

Figure 8-9. — Comparison of direct and ground-reflected waves.

The best type of surface for surface-wave transmission is sea water. Sea water accounts for the long-distance coverage attainable by the fleet broadcasts when using surface-wave transmission of the very low frequencies. The most reliable frequency band for one-way broadcasts is VLF, which can be received by submarines when completely submerged (with no part—not even the antenna—projecting above the surface of the water).

In general, the surface wave is transmitted as a vertically polarized wave, and it remains vertically polarized at appreciable distances

from the antenna. Vertical polarization is chosen because the earth has a short-circuiting effect on the intensity of a horizontally polarized wave. When the conductivity of the earth is high and the frequency of the wave is below 30 mc, the surface wave is the principal component, except in plane-to-plane or plane-to-ground transmission, in which the direct wave and ground-reflected waves are the chief means of communication. At frequencies higher than 30 mc, losses suffered by the surface wave become so excessive that transmission usually is possible only by means of the direct wave. At



frequencies where the surface wave predominates, vertical polarization is superior to horizontally polarized radiation, except in heavily wooded or jungle areas. In such areas, horizontal polarization provides better reception, even at distances and frequencies where the surface wave normally would predominate, because most of the foliage grows vertically and absorbs vertically polarized energy. Above 30 mc, where the direct wave is the main component, there is little difference between vertical and horizontal polarization.

### Tropospheric Wave

The tropospheric wave is that component of the groundwave that is refracted in the lower atmosphere by rapid changes in humidity, atmospheric pressure, and temperature. At heights of a few thousand feet to a mile or so, huge masses of warm and cold air exist near each other, causing abrupt differences in temperature and pressure. The resulting tropospheric refraction and reflection make communication possible over distances far greater than can be covered by the ordinary groundwave. Because the amount of refraction increases as the frequency increases, tropospheric refraction is more effective at the higher frequencies, particularly above 50 mc. Temperature inversion is a common cause of tropospheric refraction. This means that warm layers of air are located above cooler layers. Temperature inversion results from several causes. They include a warm air mass overrunning a colder mass, the sinking of an air mass heated by compression, the rapid cooling of surface air after sunset, and the heating of air above a cloud layer by reflection of the sunlight from the upper surface of the clouds. Tropospheric wave propagation depends on weather conditions and, because weather conditions do vary from minute to minute, they can cause fading of the radio signal. The receiving and transmitting antennas should have the same type of polarization, inasmuch as the tropospheric wave maintains essentially the same polarization throughout its travel. Temperature inversions in the tropics and over the oceans are present almost continuously at heights up to 3000 feet. When the boundary of the inversion is defined sharply, waves traveling horizontally become trapped by the refracting layer of air and continue to be sent back toward the earth. Figure 8-10 shows how such a trapped wave follows a duct, the up-

per and lower walls of which are formed by the temperature inversion boundary and the surface of the earth. Thus, the waves follow the curvature of the earth for distances far beyond the normal horizon of the transmitter and, in some localities, may consistently reach distances of many thousands of miles. Duct transmission usually is effective at only UHF and VHF frequencies. A necessary feature of duct transmission, if communication is to be established by this means, is that both the transmitting and the receiving antennas must be inside the duct. A transmitting antenna above the duct, as on a tower or mast, does not operate into the duct, and no signals by this means are received at the receiving antenna. Moreover, a receiving antenna below a duct receives no signals from an airplane flying in or above the duct, even though line-of-sight conditions prevail.

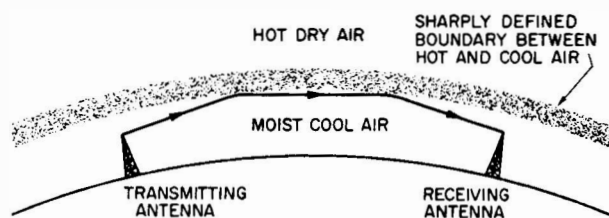

Figure 8-10. —Transmission by means of tropospheric duct. 31.14

### IONOSPHERE

Now let's consider the ionosphere in detail and see how the different levels of ionization affect the propagation of radio waves. Although the earth's atmosphere extends to a distance of over 250 miles, the air particles beyond this height are so rare that they are practically nonexistent. Our atmosphere is under constant bombardment by radiation and particle showers from the sun and by cosmic rays whose source is not yet known. Not only does the radiation from the sun include the light rays that we see, but also the entire spectrum (series of wavelengths), ranging from infrared rays to ultraviolet rays. As these forms of radiation approach the atmosphere of the earth, they reach certain critical levels where the gases are of such density that they are particularly susceptible to ionization by their action. This means that the radiation from the sun is capable of dislodging some of the loosely bound electrons from the gas atoms, and the gas then is said to be ionized. The reason it is ionized is that it

has positively charged atoms (called ions) lacking their normal amount of electrons, and free electrons unassociated with any atom. The predominant source of ionization is ultraviolet radiation from the sun.

The ionosphere consists of four distinct layers. They are called, in order of increasing heights and intensities, the D, E, F1, and F2 layers. The relative distribution of these layers about the earth is indicated in figure 8-11. As may be seen in this illustration, the four layers are present only during the daytime, when the sun is directed toward that portion of the atmosphere. During the night, the F1 and F2 layers merge into a single F layer, and the D and E layers fade out. It is well to remember that the actual number of layers, their heights above the earth, and the relative intensity of ionization present in the layers vary from hour to hour, from day to day, from month to month, from season to season, and from year to year.

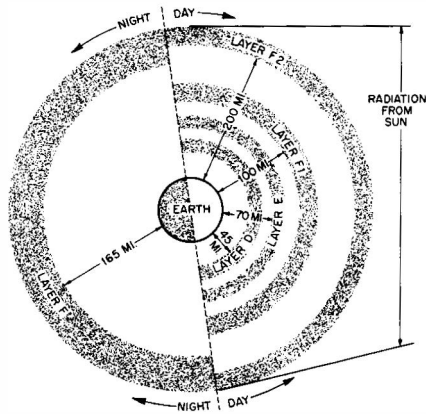

Figure 8-11. —Ionosphere layers 31. 15

### D Layer

Between heights of 30 to 55 miles above the surface of the earth is the first region of pronounced ionization, known as the D layer. The amount of ionization in the D layer is not extensive and has little effect in bending the paths of high-frequency radio waves, although it does weaken or attenuate such waves crossing through this region, and at times may absorb low- and medium-frequency waves completely. The D layer exists only during the daytime. Its density follows the variation of the sun, becoming densest at noon, and fading out shortly after sunset. It is chiefly responsible for the

intensity of high-frequency waves being lower when the transmission is in sunlit hours than during darkness.

### E Layer

The second region in order of height, called the E layer, lies at heights between 55 and 90 miles. Its height varies somewhat with the season. Lower heights occur when the sun is in that latitude, probably because the ultraviolet radiation penetrates farther into the atmosphere when the sun is more directly overhead. Ionization of the E layer follows the sun's altitude variations closely. It attains its maximum at about noon, fading to such a weak level during the night that it is practically useless as an aid to high-frequency radio communication. Ionization in this layer usually is sufficient to bend back to earth radio waves at frequencies as high as 20 mc. Thus, the E layer is of great importance to radio transmission for distances less than approximately 1500 miles. For longer distances, transmission by this means is rather poor. At distances greater than 1500 miles, better transmission can be obtained by means of the F, F1, and F2 layers.

### F Layer

At heights between 90 and 240 miles above the earth's surface is another region of ionization, known as the F layer. Ionization exists at all hours, usually with two well-defined layers during the daytime and one during the night. In this region, at night, the single F layer lies at a height of about 170 miles, and the atmosphere is so rare at that height that sufficient ions remain throughout the night to refract high-frequency waves back to earth.

### F1 and F2 layers

During daylight hours, especially when the sun is high (as in the tropics), and during summer months, the F region splits into two distinct layers—the F1 and F2. Depending on the seasons and the time of day, the F1 has a lower limit at a height of approximately 90 miles, and the F2 has a lower limit at a height of about 160 to 220 miles. The F2 layer is the most highly ionized of all the layers and is the most useful for long-distance radio communication. The intensity of ionization reaches a maximum in the afternoon and gradually decreases through-

out the night, with a rapid rise in ion density in the morning.

### Other Layers

In addition to the regions of ionization that appear regularly and undergo variations in height and intensity daily, seasonally, and from year to year, other layers appear occasionally. They appear particularly at heights near that of the E layer, much as clouds appear in the sky. Frequently their appearance is of sufficient intensity to enable good radio transmission to take place by means of reflection from them. At other times, especially during disturbances in polar regions (such as those that cause the northern lights), ionization may occur over such a large range of heights that it is detrimental to radio transmission because of the excessive absorption of the radio wave.

## VARIATIONS OF IONOSPHERE

Because the existence of the ionosphere depends on radiations from the sun, it is obvious that variations in the ionosphere result from the movement of the earth about the sun or from changes in the sun's activity that might cause an increase or decrease in the amount of its radiation. These variations include (1) changes that are more or less regular in their nature, thus predictable in advance, and (2) irregular variations resulting from the abnormal behavior of the sun. Regular variations are divided into four classes: daily, seasonal, 11-year, and 27-day variations.

Table 8-3 lists the regular variations, together with the effects upon the ionosphere and on radio communications. It also gives suggestions that may be followed in compensating for the various effects.

### Daily Variations

In table 8-3 you will note that higher frequencies are suggested for daytime use, and lower frequencies at night, to compensate for daily variations. The reason for this is that ionization of the F2 layer is greater during the daytime. Also, the F2 layer reflects waves of higher frequency than the F layer during the night. The higher frequency waves suffer less absorption in passing through the D region, whereas the disappearance of the D region at night permits lower frequencies.

### Seasonal Variations

While the apparent position of the sun moves from one hemisphere to the other as seasons change, the maximum ionization in the D, E, and F1 layers shifts accordingly. Ionization of each layer is greater during the summer. The F2 layer does not follow this seasonal shift pattern. In most localities, the F2 ionization is greatest in winter and least in summer, which is quite the reverse of what might be expected. In winter, ionization of the F2 layer rises sharply at about noon, maintaining a much higher density than in summer. Separation of the F1 and F2 layers is not so well defined in summer because the height of the F2 layer is less during that season.

### 11-Year Sunspot Cycle

Sunspot activity varies in conformity with an 11-year cycle. Sunspots affect the amount of ultraviolet radiation and likewise affect the ionization of the atmosphere. During periods of high sunspot activity, the ionization of the various layers is greater than usual, resulting in higher critical frequencies for the E, F1, and F2 layers, and higher absorption in the D region. Consequently, higher frequencies are permitted for communication over long distances at times of greatest sunspot activity. Increased absorption in the D region, which has the greatest effect on the lower frequencies, requires the use of higher frequencies. The overall effect is an improvement in propagation conditions during years of maximum sunspot activity.

### 27-Day Sunspot Cycle

Another cycle due to sunspot activity is the 27-day variation, caused by the rotation of the sun on its axis. As the number of sunspots changes from day to day with rotation of the sun, the formation of new spots, or the disappearance of old ones, absorption by the D region also changes. Similar changes are observed in the E layer, and cover a wide geographic range. Fluctuations in the F2 layer are greater than for any other layer, but usually are not of a worldwide character.

RADIOMAN 3 & 2

Table 8-3 — Regular Variations of Ionosphere

Type of variation	Effect on ionosphere	Effect on communications	Method of compensation
Daily	<p>F layer: Height and density decrease at night, increase after dawn. During day, layer splits into (1) F1 layer: Density follows vertical angle of sun; (2) F2 layer: Height increases until midday, density increases until later in day.</p> <p>E layer: Height approximately constant, density follows vertical angle of sun. Practically non-existent at night.</p> <p>D layer: Appears after dawn, density follows vertical angle of sun, disappears at night.</p>	<p>Skip distance varies in 1-mc to 30-mc range. Absorption increases during day.</p>	<p>Use higher frequencies during day, lower frequencies at night.</p>
Seasonal	<p>F2 layer: Heights increase greatly in summer, decrease in winter. Ionization density peaks earlier and reaches higher value in winter. Minimum predawn density reaches lower value in winter.</p> <p>F1, E, and D layers: Reach lower maximum densities in winter months.</p>	<p>Maximum usable frequencies generally reach higher midday values in winter but maintain high values later in afternoon in summer. Predawn dip in maximum usable frequencies reaches lower value in winter. Less absorption in winter.</p>	<p>Provide greater spread between nighttime and daytime operating frequencies in winter than in summer.</p>
11-year sunspot cycle.	<p>Layer density increases and decreases in accord with sunspot activity (maximum 1958-1959 and 1969-1970; minimum 1955, 1966).</p>	<p>Higher critical frequencies during years of maximum sunspot activity. Maximum usable frequency variation: Sunspot max: 8-42 mc; sunspot min: 4-22 mc.</p>	
27-day sunspot cycle.	<p>Recurrence of sudden ionospheric disturbances at 27-day intervals. Disturbed conditions frequently may be identified with particularly active sunspots whose radiations are directed toward the earth every 27 days as the sun rotates.</p>	<p>Normally usable frequencies above 1 mc are rendered useless because of high absorption in the abnormally ionized D layer. Frequencies higher than normal will survive this absorption for short hops. Low frequencies may not penetrate the D layer and thus may be transmitted for long distances.</p>	<p>Raise working frequency above normal for short-hop transmission. Lower frequency below normal for long-hop transmission.</p>

## Irregular Variations

In addition to the regular variations of the ionosphere, a number of transient effects, though unpredictable, have an important bearing on propagation of the skywave. Some of the more prevalent of these effects are sporadic E, sudden ionospheric disturbance, ionospheric storms, and scattered reflections.

The sporadic E is an ionized cloud that appears at indefinite times and at a greater height than the normal E layer. Sometimes it is capable of reflecting so much of the radiated wave that reflections from the other layers of the ionosphere are blanked out completely. The sporadic E may be so thin at other times that reflections from the upper layers can be received through it easily. Although the sporadic E layer is more prevalent in the tropics than in the higher latitudes, its occurrence is frequent. It may occur during the night or day.

The most startling of all irregularities of radio wave transmission is the sudden type of ionospheric disturbance (SID) causing a radio fadeout. This disturbance, caused by a solar eruption of ultraviolet radiation, comes without warning and may last for a few minutes or for several hours. All stations on the sunlit side of the earth are affected, and, at the onset of the disturbance, receiving operators are inclined to believe that their radio sets are dead. The solar eruption causes a sudden increase in the ionization of the D region, frequently accompanied also by disturbances in the earth's magnetic field. The increased ionization of the D region usually causes total absorption of the skywave at all frequencies above 1000 kc.

An ionospheric storm is caused mainly by particle bombardment and usually follows an SID by approximately 18 hours. The storm may last from several hours to several days and usually extends over the entire earth. High-frequency skywave transmission is subject to severe fading, and wave propagation is erratic. Often, it is necessary to lower the frequency to maintain communications during one of these storms.

Scattered reflections frequently occur from irregular layers in the ionosphere, and may happen at all seasons, both day and night. A radio wave can reflect from either the top or bottom of one of these scattering ionospheric clouds, causing signal distortion and so-called flutter fading. In general, fading is of short

duration, and usually no compensation by the radio operator is required.

## SKYWAVE

Skywave propagation makes use of ionospheric reflections and refractions to provide signal paths between transmitters and receivers. Skywave transmission is by far the most important method for long-distance radio communications. But it presents many problems that can be solved adequately only through an understanding of the principles of skywave composition.

Figure 8-12 illustrates some of the many possible paths of radio waves from a transmitter to a receiver by reflection from the ionosphere. Note that some of the waves are assumed to be too high in frequency for reflection by the ionized layer, and pass on through and are lost in outside space unless they are reflected from a higher layer that has a greater degree of ion density. Other components of the wave, which are of the correct frequency for reflection from the ionospheric layer, are returned to earth. These latter components of the wave are the ones that provide communications. Figure 8-12 also shows that the skip distance extends from the transmitting antenna to the nearest point at which the reflected waves return to earth. The skip zone and its relation to the ground wave are shown in figure 8-13. If the skywave returns to earth at a point where the groundwave and skywave are of nearly equal intensity, the skywave alternately reinforces and cancels the groundwave, resulting in severe fading of the signal. Fading is caused by the phase difference between groundwaves and skywaves resulting from the longer path traveled by skywaves.

Note the distinction between the terms "skip distance" and "skip zone." For each frequency at which reflection from an ionospheric layer takes place, there is a skip distance that depends on the frequency and the degree of ionization present. The skip zone, on the other hand, depends on the extent of the groundwave range and disappears entirely if the groundwave range equals or exceeds the skip distance.

The distance at which the wave returns to earth depends on the height of the ionized layer and the amount of bending of the wave. Upon return to the earth, part of the energy enters the earth and is dissipated rapidly, but part is reflected back into the ionosphere, where it

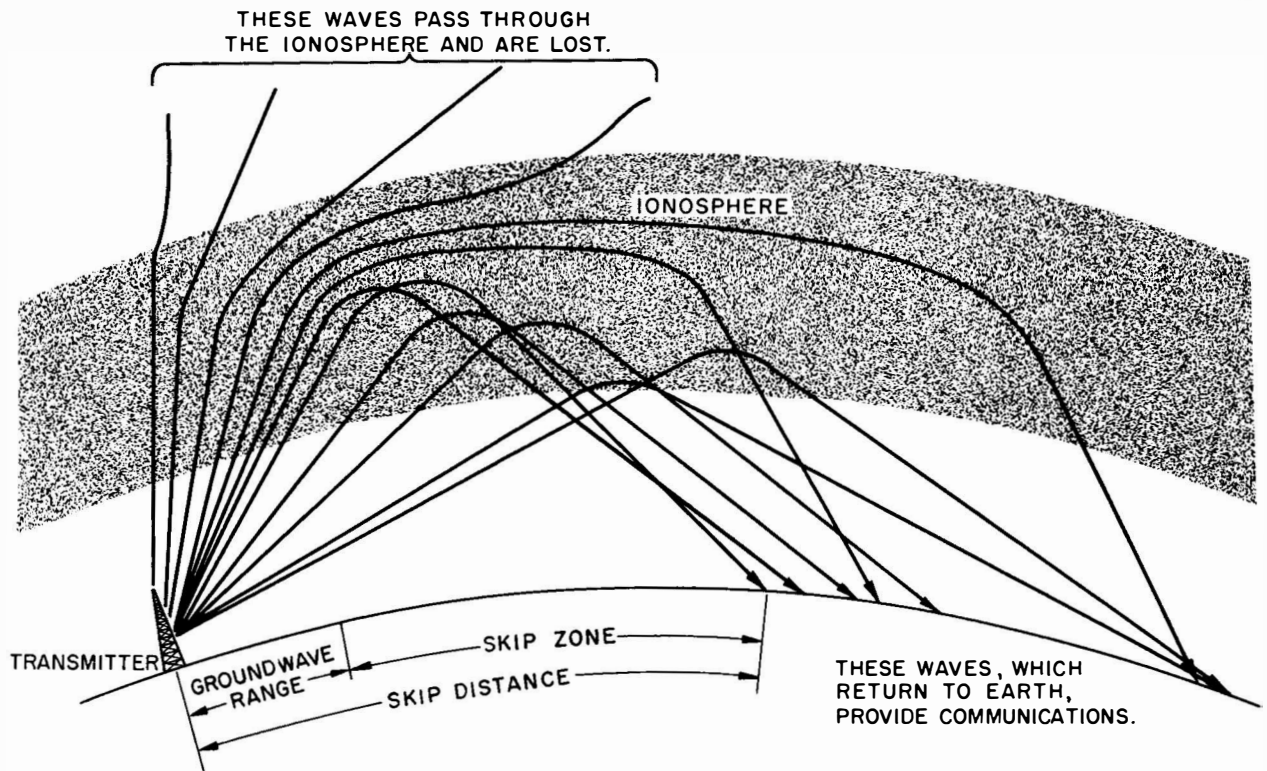

31. 16

Figure 8-12. —Skywave transmission paths.

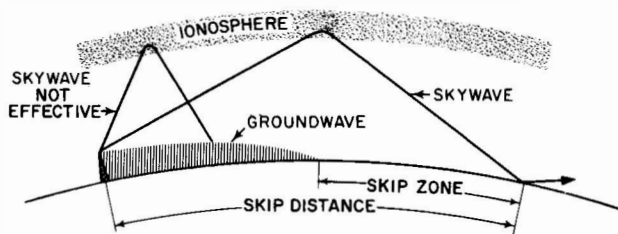

31. 17

Figure 8-13. —Relation of skip zone and groundwave.

may be reflected downward again at a still greater distance from the transmitter. This means of travel in hops—by alternate reflections from the ionosphere and from the surface of the earth—may continue, and enables transmissions to be received at great distances from the transmitter. Figure 8-14 illustrates the hop means of travel for paths involving one and two reflections from the ionosphere (called single- and double-hop).

As mentioned earlier, in the discussion of the ionosphere, the higher the frequency of a wave, the less it is refracted by a given degree

of ionization. Figure 8-15 shows three separate waves of different frequencies entering an ionospheric layer at the same angle. Here, the 100-mc wave is not refracted sufficiently by the ionosphere, and is not returned to earth. The 5-mc and the 20-mc waves are returned. But the 20-mc wave, refracted less than the 5-mc wave, returns at a greater distance from the transmitter.

### MAXIMUM USABLE FREQUENCY (MUF)

Early experimenters in high-frequency radio transmission learned that, for a fixed distance of transmission, an upper limit of frequency would return to earth at that distance. The upper-limit frequency is greater for greater distances, greater in the daytime than at night, and greater on a winter day than on a summer day. The existence of this upper-limit frequency depends on the ionization in the ionosphere reflecting only waves of frequencies less than a certain critical value. This value is called the maximum usable frequency, abbreviated MUF. At frequencies above the MUF for a given distance, the wave is said to skip, be-

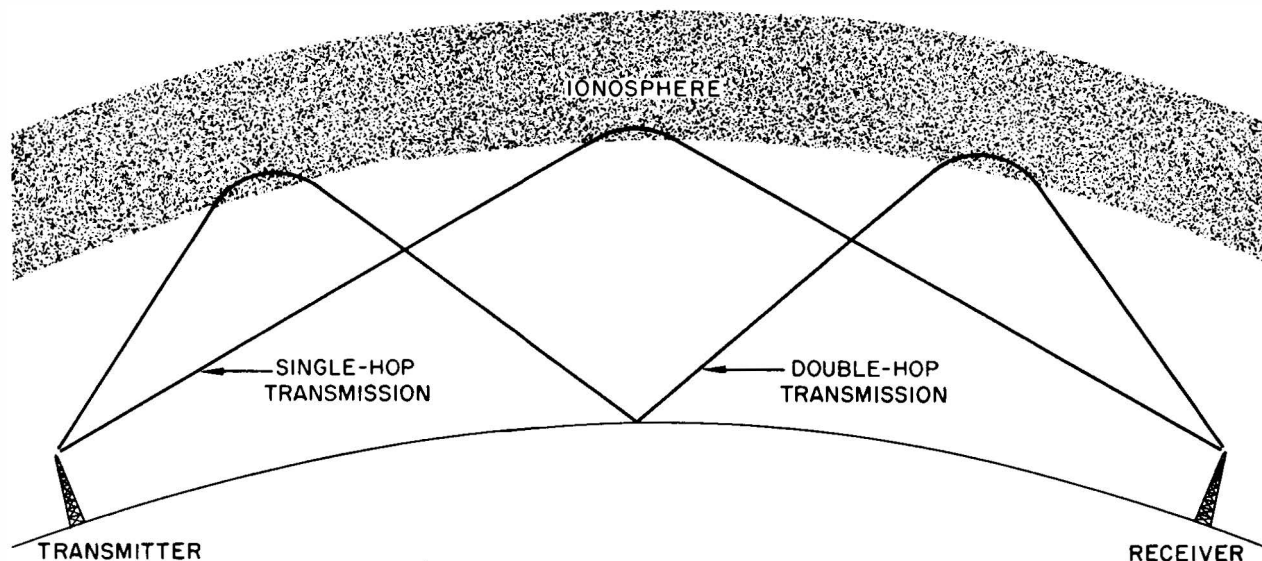

31.18

Figure 8-14. — Single- and double-hop transmissions.

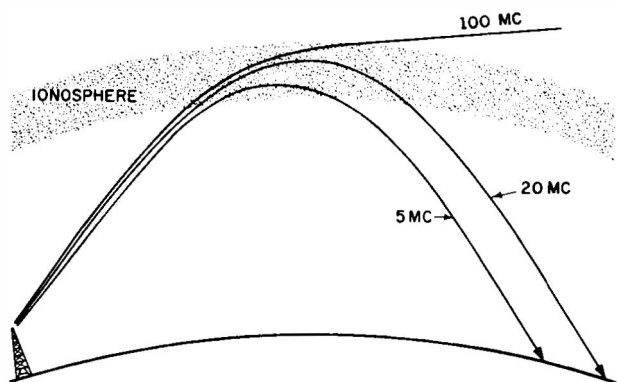

31.19

Figure 8-15. — Frequency versus distance for returned waves.

cause it then returns to earth at a greater distance from the transmitter.

It is important to know the MUF for any transmission path at any particular time. If the operating frequency is above the MUF, the wave skips, because it is not reflected from the ionosphere at the desired distance. If the operating frequency is decreased below the MUF in the daytime, it is weakened, or attenuated. In the high-frequency range, attenuation occurs because the lower the frequency, the greater its absorption in the ionosphere. Hence, it usually is desirable to transmit on a frequency as near the MUF as possible. Inasmuch as a direct relationship exists between the MUF, the

condition of the ionosphere, and time, it is possible to predict the MUF for any transmission path months in advance.

#### FREQUENCY GUIDE

The Central Radio Propagation Laboratory of the National Bureau of Standards receives and analyzes ionospheric data from many stations throughout the world. These ionospheric data, in the form of MUF predictions, are utilized by the Armed Forces as well as by many others. To assist the Navy communicator, the DNC 14 series, entitled Recommended Frequency Bands and Frequency Guide, is published quarterly, 3 months in advance of its effective date. The publication contains tables of frequency bands recommended for use under normal conditions for communication to and from the principal shore stations. Included also are graphs, called nomograms, that are a rough guide for radio operators in the choice of suitable frequencies for communication over distances up to 2200 miles. In most instances, you will find that the exact frequency recommended in DNC 14 is not available for your use. You then should select an available frequency as near as possible, but not exceeding, the MUF. If a frequency higher than the MUF is used, it is improbable that reliable communications will result.

## ANTENNAS

An antenna is a conductor or a system of conductors for radiating (transmitting) or intercepting (receiving) radio waves.

The subject of antennas and antenna theory covers a broad field. Most antenna theory is based on the performance of an antenna located in free space--away from all modifying influences such as the earth. In actual practice, however, this condition is almost impossible to attain. There are many reasons why the antenna performs differently from the ideal free space theory, particularly on shipboard where space limitations cause adverse effects.

Any wire carrying alternating current radiates some energy because of the changing electromagnetic field. Perhaps you have noticed the interference in an automobile radio when near powerlines. A powerline, of course, is a poor antenna because it was designed for carrying energy instead of radiating energy.

Usually, discussions of antenna theory concern antennas used for transmitting, although an efficient transmitting antenna for any particular frequency is also an efficient receiving antenna for that same frequency. It must be remembered, however, that there may be other limitations affecting the use of an antenna for both transmitting and receiving.

## ANTENNA LENGTH

The strength of the radio wave radiated by an antenna depends upon the length of the antenna and the amount of current flowing in it. Because the antenna is a circuit element having inductance, capacitance, and resistance, the largest current is obtained when the inductive and capacitive reactances (opposition to the flow of alternating current) are tuned out; that is, when the antenna circuit is made resonant at the frequency being transmitted.

The shortest length of wire that will be resonant at any particular frequency is one just long enough to permit an electric charge to travel from one end of the wire to the other end and back again in the time of 1 cycle. The distance traveled by the charge is 1 wavelength. Because the charge must travel the length of the wire twice, the length of wire needed to have the charge travel 1 wavelength in 1 cycle is half a wavelength. Thus, the half-wave antenna is the shortest resonant length and is used as the basis for all antenna theory.

An antenna can be made resonant by two methods. These methods are adjusting the frequency to suit a given antenna length or, as usually is more practical, adjusting the length of the antenna wire to suit a given frequency. It is, of course, impractical to lengthen or shorten an antenna physically every time the transmitter is changed to a new frequency. The antenna length may, however, be changed electrically. This is accomplished by a process known as tuning, or loading, the antenna.

The electrical length of an antenna is not necessarily the same as its actual physical length. We learned that radio waves travel 186,000 miles per second in free space. The radio frequency energy on an antenna, however, moves at a speed considerably less than that of the radiated energy in free space. Because of the difference in velocity between the wave in free space and the wave on the antenna, the physical length of an antenna no longer corresponds to its electrical length. Thus, a half-wave antenna (called a dipole) is half a wavelength electrically, but somewhat shorter physically.

Assume that a station wishes to transmit on a frequency of 3 mc. Applying the formula for finding wavelength in meters:

$$\frac{300}{3} = 100 \text{ meters (wavelength).}$$

Or, if you prefer to express the wavelength in feet:

$$\frac{984}{3} = 328 \text{ feet (wavelength).}$$

The wavelength, 328 feet, found by the preceding formulas, would also be the correct length of a full-wave antenna for 3-mc transmission except for the differences between the actual and electrical antenna lengths. A dipole for that frequency would be half the length, that is, 164 feet (or 50 meters).

The formulas, correct for finding wavelength, do not hold true for finding antenna length except for an ideal antenna, completely free of the influence of the earth. If the antenna were made of very thin wire and isolated perfectly in space, its electrical length would correspond closely to its physical length. Actually, though, the antenna is never isolated completely from surrounding objects. The circumference of the wire itself, and the capacitance introduced by insulators and nearby objects combine to change the velocity of the wave in the antenna. This is called END EFFECT, because the ends of the antenna are made far-



ther apart electrically than they are physically. Consequently, the physical length of a half-wave antenna should be about 5 percent shorter than the corresponding wavelength in space. The following formula can be used for finding the correct length, in feet, of half-wave antennas:

$$\text{Antenna length (in feet)} = \frac{468}{\text{Frequency (in mc)}}$$

By substituting, we find that the correct antenna length for 3 mc is:

$$\frac{468}{3} = 156 \text{ feet.}$$

The formula is accurate for all practical purposes in calculating the actual or physical length of a half-wave antenna for frequencies up to 30 mc.

### HALF-WAVE DIPOLE

The half-wave dipole (sometimes called a Hertz or doublet) is an antenna with a length approximately equal to half a wavelength at the frequency being transmitted. A transmitter, remember, is merely a high-frequency generator of alternating current. If a feeder line from a transmitter is connected to the center of a dipole, the antenna will act as though an a-c generator were set between two quarter-wave antennas, as in figure 8-16. During one-half the generator's alternation, electrons in the antenna flow from right to left (fig. 8-16, view B). During the next half alternation, electrons flow in the opposite direction (fig. 8-16, part C).

The dipole is the basis for many complex antennas. When used for transmitting medium and high frequencies, it usually is constructed of wire. At very high and ultrahigh frequencies, the shorter wavelength permits construction using metal rods or tubing. Depending upon the wave polarization desired, the dipole may be mounted either horizontally or vertically. Because the dipole is an ungrounded antenna, it may be installed far above the ground or other absorbing structures.

A vertical dipole, suspended in space away from the influence of the earth, would be surrounded by an electromagnetic field (called radiation pattern) the shape of a doughnut, as in figure 8-17, parts A and B. No radiation takes place at the ends of the dipole (line OA). Radiation increases progressively through lines OB and OC, until the maximum radiation is obtained on a horizontal plane.

The field radiated by a horizontal dipole is in the shape of a doughnut standing on edge.

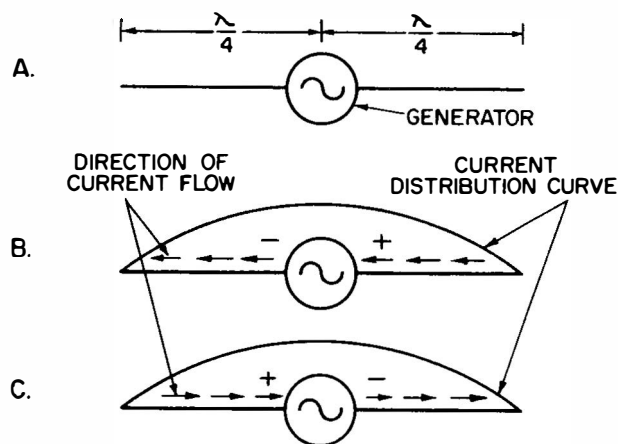

20. 242

Figure 8-16. —Instantaneous direction and distribution of current in a dipole.

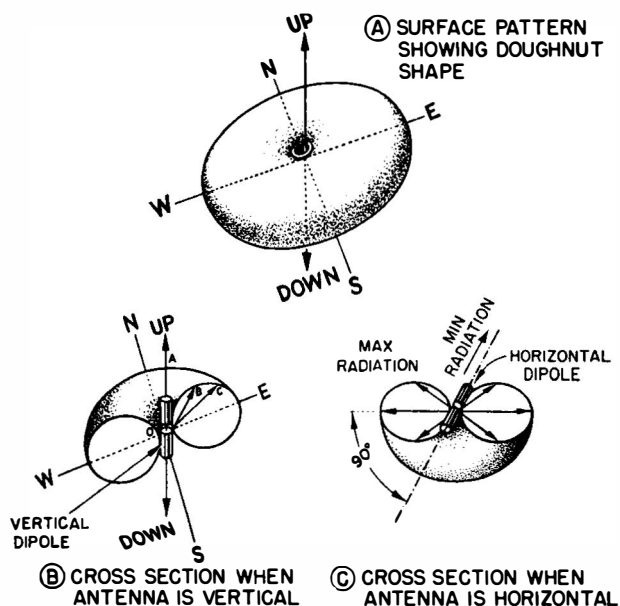

1. 255

Figure 8-17. —Electromagnetic field surrounding a dipole.

Figure 8-17, part C, shows half of the doughnut pattern for a horizontal dipole. Again, the maximum radiation takes place in a plane perpendicular to the axis of the antenna.

At the low and medium frequencies, half-wave antennas are rather long and have little use in the Navy except at shore stations where there is room for them. A dipole for 500 kc, for example, would have to be about 936 feet long. At lower frequencies another basic type of antenna affords a solution to the problem of undue length. It is the quarter-wave antenna.

QUARTER-WAVE ANTENNA

The quarter-wave antenna is known also as the Marconi antenna. The latter term is being replaced by more descriptive terms relating to specific types of quarter-wave antennas.

The earth is a fairly good conductor for medium and low frequencies, and acts as a large mirror for the radiated energy. The result is that the ground reflects a large amount of energy that is radiated downward from an antenna mounted over it. It is as though a mirror image of the antenna is produced, the image being located the same distance below the surface of the ground as the actual antenna is located above it. Even in the high-frequency range (and higher), many ground reflections occur, especially if the antenna is erected over highly conducting earth or salt water.

Utilizing this characteristic of the ground, an antenna only a quarter-wavelength long can be made into the equivalent of a half-wave antenna. If such an antenna is erected vertically and its lower end is connected electrically to the ground (fig. 8-18), the quarter-wave antenna behaves like a half-wave antenna. Here, the ground takes the place of the missing quarter-wavelength, and the reflections supply that part of the radiated energy that normally would be supplied by the lower half of an ungrounded half-wave antenna.

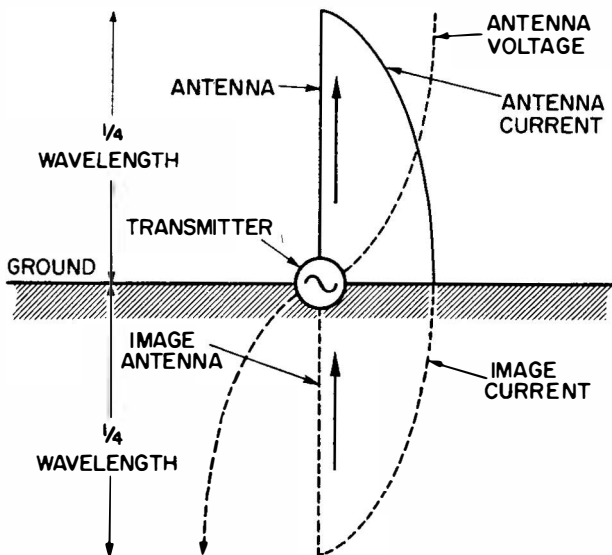

13. 35(76)

Figure 8-18. —Grounded quarter-wave antenna, showing image current.

The relationship of current and voltage in a quarter-wave antenna is similar to that in a dipole. Voltage is greatest at the top of the antenna and least at the bottom. Current is greatest at the bottom and least at the top.

Figure 8-19 shows the radiation pattern produced by a grounded quarter-wave antenna. One bad feature of these shorter antennas is that the radiation is less than that of a half-wave antenna. The radiation decreases with the length of antenna wire used, because less wire is carrying the high current that produces radiation.

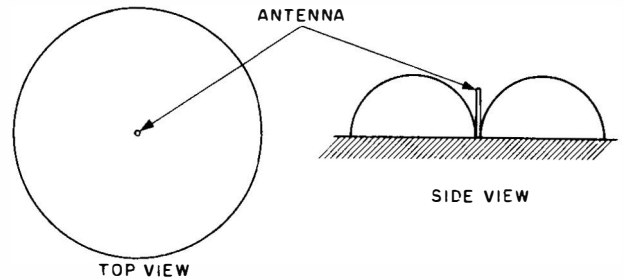

76. 12

Figure 8-19. —Radiation pattern of a grounded quarter-wave antenna.

Space limitations aboard ship usually prohibit the installation of vertical antennas that are long enough to be resonant at the low and medium frequencies. Two principal methods have been found for improving shipboard antennas that are electrically short at the lower frequencies.

One method of increasing the effective height of a short vertical antenna is by means of a flattop. A length of wire equal to the missing length of the antenna is added to it to form a horizontal flattop (fig. 8-20). In this way the current in the vertical section is made more nearly constant, thus increasing the effective height of the antenna. Actually, the flattop contributes very little to the radiation, most of which comes from the vertical portion of the antenna.

Another method for making the antenna resonant, when short antennas must be used at low frequencies, is to add an inductance (called a loading coil) at the base of the antenna. Inductance has the effect of increasing the antenna length. If the antenna must be used over a wide frequency range, a large variable capacitor is

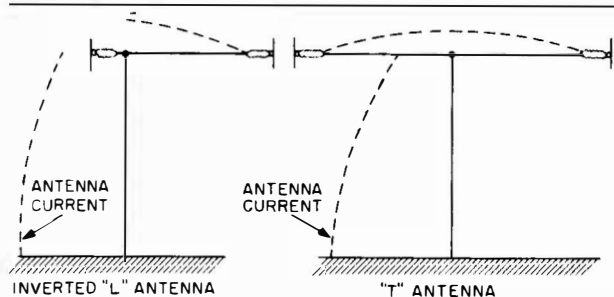

76.13

Figure 8-20. — Flattop antennas and their current distribution.

placed in series with the loading coil. The capacitor has the effect of shortening the antenna. The combination of the loading coil and the capacitor permits the antenna to be tuned to resonance over a wider frequency range.

A different method of operating a vertical quarter-wave antenna is to use a ground plane with the antenna. Usually the ground plane is made of wires or rods extending radially from the base of the antenna. The ground plane actually substitutes for the ground connection thereby establishing the ground level at the base of the antenna. Thus the antenna can be installed high above ground on masts or towers. Ground plane antennas of this sort are used mostly for VHF and UHF communications.

### STANDING WAVES

If an antenna is energized by an alternating current of a frequency equal to the antenna's resonant frequency, the current and voltage values vary along the length of the wire, and always are  $90^\circ$  out of phase. Figure 8-21 shows the relationship of current and voltage in a full-wave antenna. The points where voltages or current are maximum are called voltage or current loops. Points of minimum voltage or current are known as voltage or current nodes. You will notice that current and voltage nodes appear every half wavelength, but are separated from each other by one-fourth wavelength.

The wave of energy sent out by the transmitter travels to the ends of the antenna, and from there it is reflected back along the length of the wire. The wave moving from the transmitter toward the end of the antenna is called the incident wave; its reflection is called the reflected wave. The time required for this process depends upon the length of the antenna, and hence upon the frequency. If the antenna is

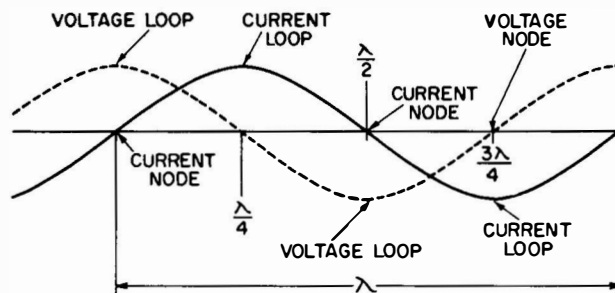

Figure 8-21. — Standing waves along full-wave antenna. 76.14

resonant to the frequency generated by the transmitter, the returning wave arrives at the driving point exactly in phase with the outgoing wave, and the two waves tend to reinforce each other. This condition continues as long as the antenna is energized. The effect is the same as though there were **STANDING WAVES** along the length of the wire instead of two sets of moving waves, as really happens. Only in the presence of standing waves does the antenna radiate at maximum.

### TYPICAL SHORE STATION ANTENNAS

It is difficult to classify a particular type of antenna as strictly a shore station type or a shipboard type unless, of course, its physical dimensions are the fundamental consideration. For this reason, several of the antennas described in the remainder of this chapter are used both ashore and afloat, even though they may be indicated as either typical shore station or typical shipboard types. The types described are merely a sampling of the many and varied antennas you will encounter.

#### Rhombic Antenna

A type of antenna used widely for long-distance transmission and reception is the rhombic, so named because of its diamond shape. Figure 8-22 shows a typical rhombic antenna.

The rhombic antenna requires so much space that its use is confined to shore stations. Because of its directive radiation pattern (fig. 8-22), it is very useful in point-to-point communications. The basic rhombic antenna has four straight wires joined to form the diamond, and it is suspended horizontally from four poles. Each leg of the antenna is at least 1 or 2 wavelengths at the operating frequency.

Length may be as many as 12 or more wavelengths, so that rhombic antennas, even for high-frequency work, have leg lengths of several hundred feet.

Some of the advantages of the rhombic antenna are simplicity of construction, ease of maintenance, high gain, and its usefulness over a wide range of frequencies. It will perform even better if more than a single wire is used to form each leg. The most common of the multiwire rhombics is the three-wire type (fig. 8-23). Spacing between the three wires is greatest at the side poles and least at the ends. The three-wire rhombic provides a better match to the transmission line and, when used for receiving, greatly reduces the noise caused by precipitation static. For these reasons it is the only type of rhombic presently installed at both transmitting and receiving stations.

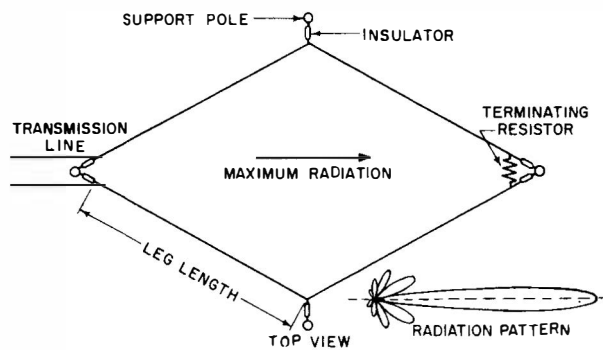

13. 37(76)A

Figure 8-22. —Typical rhombic antenna.

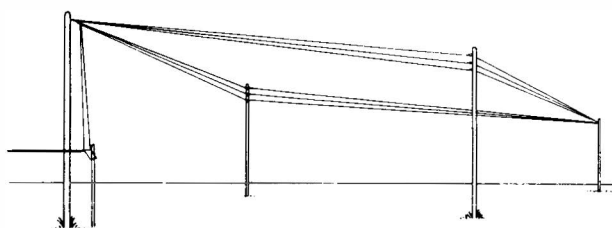

13. 37(76)B

Figure 8-23. —Three-wire rhombic.

**Sleeve Antenna**

The sleeve antenna, a high-frequency antenna, is capable of operating over a wide range of frequencies, and is known as a broad-band antenna. Originally it was developed to fill the need for a versatile, long-distance antenna at shore stations, but it has been modified for shipboard use also. Figure 8-24 is a shore

station version of a sleeve antenna. The ship-board sleeve antenna is shown in figure 8-25.

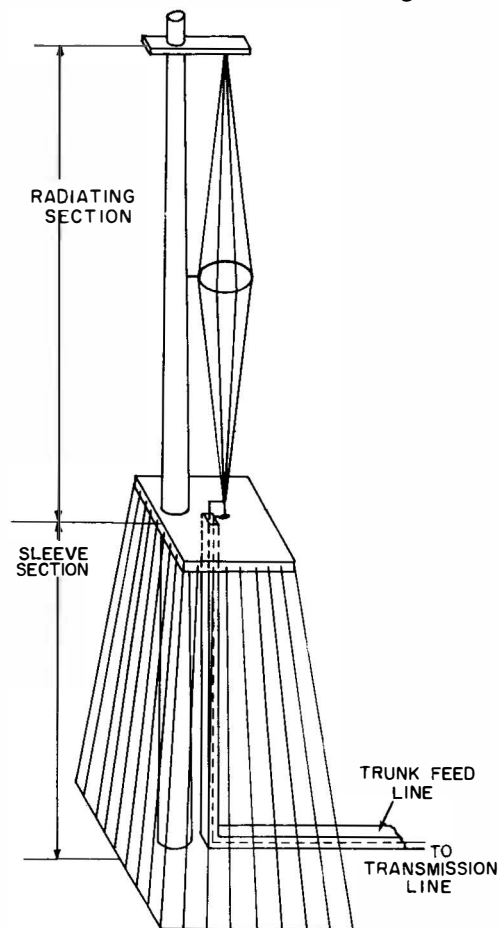

13. 40

Figure 8-24. —Sleeve antenna (shore station).

Sleeve antennas are especially helpful in reducing the total number of conventional narrow-band antennas that otherwise would be required to meet the requirements of shore stations. By using multicouplers (discussed in chapter 9), one sleeve antenna can serve several transmitters operating over a wide range of frequencies. This feature also makes the sleeve antenna ideal for small antenna sites.

**Conical Monopole Antenna**

Another broad-band antenna that is used extensively is the conical monopole shown in figure 8-26. Like the sleeve antenna, it is used both ashore and aboard ship.

When operating at frequencies near the lower limit of the high-frequency band, the conical ra-

diates in much the same manner as a regular vertical antenna. At the higher frequencies the lower cone section radiates, and the effect of the top section is to push the signal out at a low angle. The low angle of radiation causes the skywave to return to the earth at great distances from the antenna. Hence, the conical monopole antenna is well suited for long-distance communication in the high-frequency range.

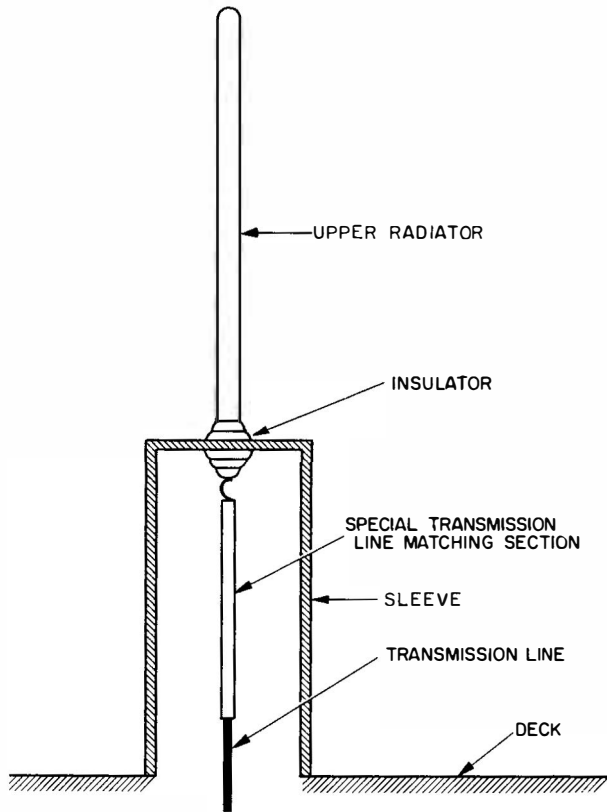

25. 217

Figure 8-25. —Sleeve antenna (shipboard).

**TYPICAL SHIPBOARD ANTENNAS**

Problems not usually present in land installations arise when antennas are installed on board ship. Most of the masts, stacks, and other structures above decks are connected electrically (grounded) to the ship's hull and, through the hull, to the water. To obtain adequate coverage from the antenna, it must be installed so that minimum distortion of the radiation pattern results from grounded structures.

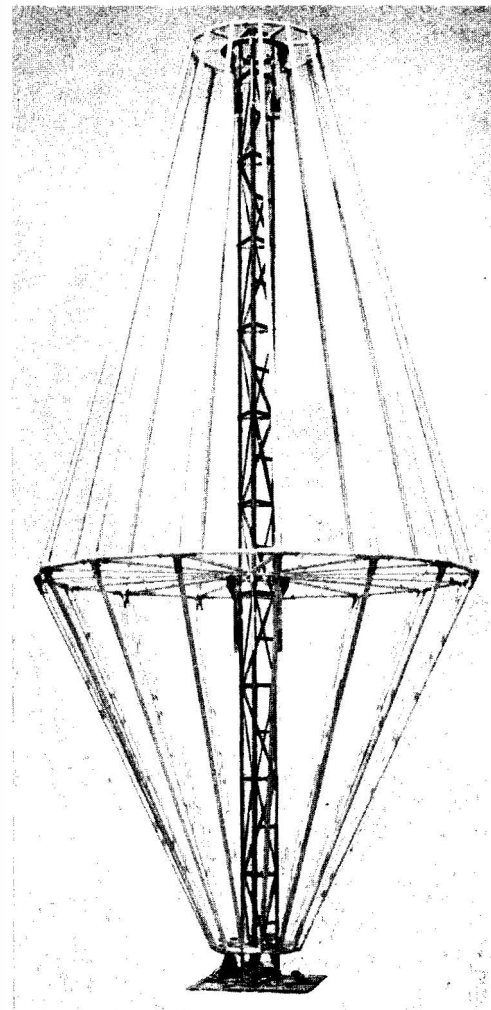

25. 214

Figure 8-26. — Conical monopole antenna.

**Wire Antennas**

Wire antennas (fig. 8-27) are installed on board ship for medium- and high-frequency coverage. Normally, they are not cut for a given frequency. Instead, a wire rope is strung either vertically or horizontally from a yard-arm (or the mast itself) to outriggers, another mast, or to the superstructure. If used for transmitting, the wire antenna is tuned electrically to the desired frequency.

Much larger wire is used for shipboard antennas than for land installations. The larger wire is less likely to break under the strain of shipboard vibrations and, in addition, can be stretched tighter to avoid sagging in hot weather. The wire is twisted and stranded for ad-

ditional strength. Usually it is made of phosphor-bronze, a material that resists corrosion and is nonmagnetic. Wire of receiving antennas ordinarily is covered with a plastic insulation, but the wire of transmitting antennas is uninsulated.

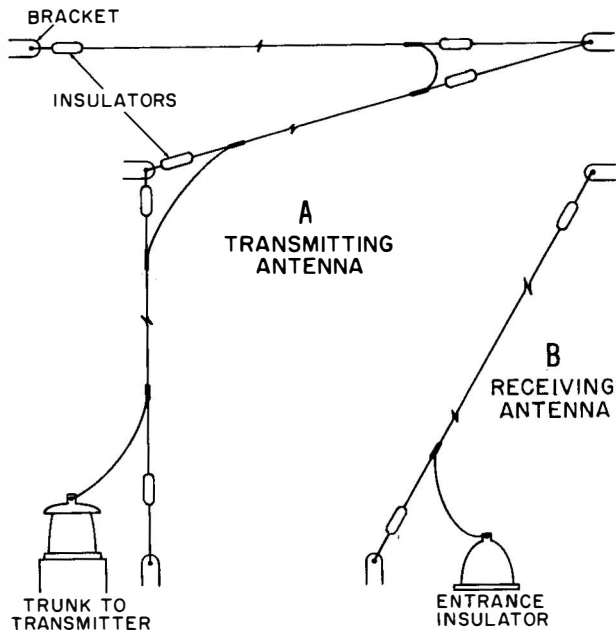

1. 46

Figure 8-27. —Shipboard wire antennas.

Receiving wire antennas normally are installed forward on the ship, rising nearly vertically from the pilothouse top to brackets on the mast or yardarm. They are located as far as possible from the transmitting antennas so that a minimum of energy is picked up from the local transmitters. The transmission line (lead-in) for each receiving antenna terminates in antenna transfer panels in the radio spaces.

Transmission lines of the transmitting antenna may be of coaxial cable or copper tubing. They are supported on standoff insulators and are enclosed in rectangular metal ducts called antenna trunks. Each transmission line connects with an individual transmitter or with an antenna multicoupler.

The metal rings, antenna knife switches, antenna hardware, and accessories associated with transmitting antennas are painted red. Hardware and accessories used with receiving antennas are painted blue. This color scheme is a safety precaution that indicates, at a glance, whether an antenna is used for radiating or receiving.

## Whip Antennas

Whip-type antennas have replaced many wire antennas aboard ship. Because they are essentially self-supporting, whip antennas may be installed in many locations aboard ship. They may be deck-mounted, or they may be mounted on brackets on the stacks or superstructure (fig. 8-28). Whip antennas commonly used aboard ship are 25, 28, or 35 feet in length, and are made up of several sections.

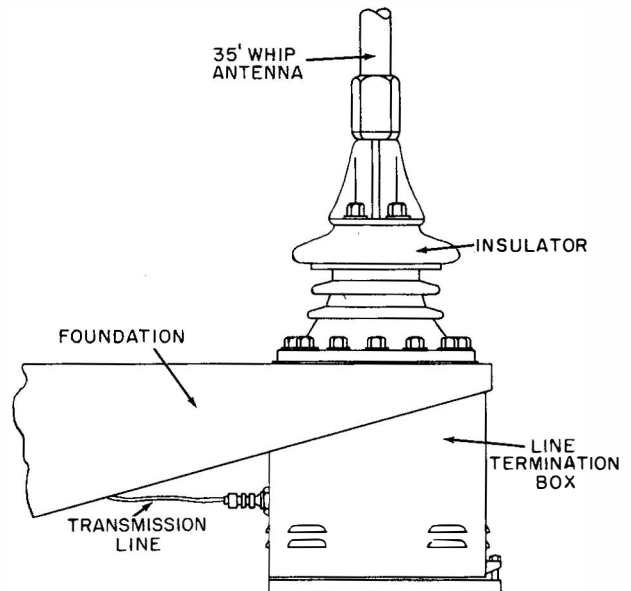

1. 47

Figure 8-28. —Whip antenna.

On aircraft carriers, whip antennas located along the edges of the flight deck can be tilted. The tilting whip is pivoted on a trunnion, and is equipped with a handle for raising and lowering the antenna. A counterweight at the base of the antenna is heavy enough to nearly balance the antenna in any position. The antenna may be locked in either a vertical or horizontal position.

Several special types of tilting mounts for whip antennas, called erecting mechanisms, are used aboard submarines. They may be operated from within the submarine. In some installations, as the submarine dives, the force of the water causes the whip to be folded back from a vertical to a horizontal position; a catch holds the antenna in this position. When the submarine surfaces, the catch is released, and a spring mechanism causes the antenna to snap back to its vertical position. In newer sub-

marines, whip antennas are mounted on retractable masts, enabling the antenna to be raised or lowered from within the submarine in much the same manner as the periscope.

### VHF-UHF Antennas

At VHF and UHF frequencies, the shorter wavelength makes the physical size of the antenna relatively small. Aboard ship these antennas are installed as high and as much in the clear as possible. The reason for the high installation is that vertical conductors, such as masts, rigging, and cables in the vicinity, cause unwanted directivity in the radiation pattern.

For best results in the VHF and UHF ranges, both transmitting and receiving antennas must have the same polarization. Vertically polarized antennas are used for all ship-to-ship, ship-to-shore, and air-ground VHF-UHF communications. Usually, either a vertical half-wave dipole or a vertical quarter-wave antenna with ground plane is used.

A UHF antenna of the half-wave (dipole) type is the AT-150/SRF (fig. 8-29). The horizontal (longer) portion of the antenna does not radiate, but acts as a mounting arm for the antenna and as an enclosure for the antenna feed line. This type of antenna is mounted horizontally.

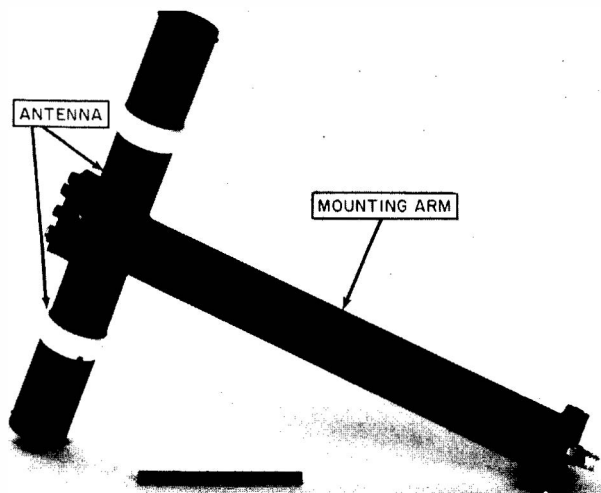
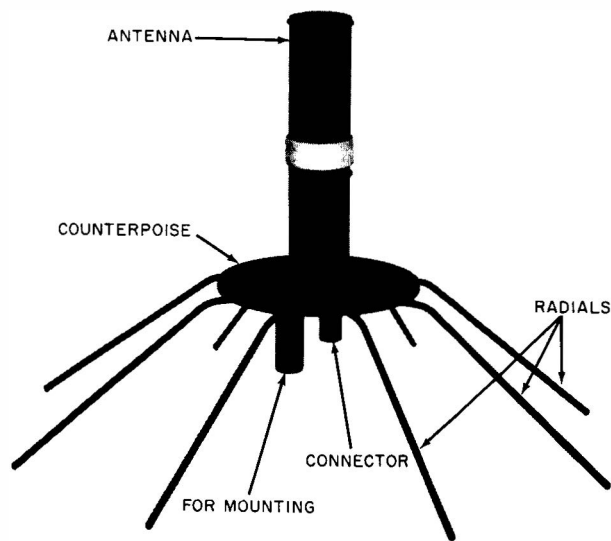

Figure 8-29. —UHF antenna AT-150/SRC.  
25.219

The AS-390/SRC (fig. 8-30) is a quarter-wave UHF antenna with a ground plane. The ground plane consists of a round plate (called a counterpoise) and eight equally spaced drooping

radials (rods). The antenna is mounted vertically.



25.220

Figure 8-30. —UHF antenna AS-390/SRC.

### EMERGENCY ANTENNAS

Loss or damage to an antenna from heavy seas, violent winds, or enemy action may cause serious disruption of communications. Sections of a whip antenna may be carried away, insulators may be damaged, or a shell burst may cause a wire antenna to snap in half. If loss or damage should happen when all available equipment is needed, you will have to rig an emergency antenna (or at least assist the ETs) to restore communications on a temporary basis until the regular antenna can be repaired.

Emergency antennas vary considerably in design. Among the influences affecting their design are the type of ship, the location of transmitting or receiving equipment, the availability of space, and the suitability of nearby structures for rigging the antenna quickly.

The simplest emergency antenna consists of a length of wire rope to which a high-voltage insulator is attached to one end and a heavy alligator clip or lug is soldered to the other. The end with the insulator is hoisted to the nearest mast, yardarm, or other high structure and secured. The end with the alligator clip (or lug) is attached to the equipment transmission line. To radiate effectively, the antenna must be sufficiently clear of all grounded objects.

Well in advance of any possible emergency situation, emergency antennas should be cut to

proper length and insulators and other necessary hardware installed. They are then stowed in the radio spaces so that they are readily accessible.

Be sure you know how and where to rig your ship's emergency antennas!

#### ANTENNA TUNING

As you learned earlier, shipboard antennas used for communications at medium and high frequencies are not usually of the proper length to give optimum performance at the operating frequency. This condition exists because all the antennas are of a standard size and shape, or they are installed in whatever space may be available for them, or because each antenna is operated at more than one frequency. All transmitting equipment must be able to operate at any frequency within its tuning range. It is necessary, therefore, to employ some means at the transmitter for adjusting the antenna for reasonable efficiency at any frequency, re-

gardless of the physical size or arrangement of the antenna.

Because each transmitter usually is associated with only one antenna, which is of fixed length, adjustment of the effective length of the antenna must be made electrically. This process, called antenna tuning, is accomplished by increasing or decreasing the inductance and/or the capacitance in the antenna system at the point where the antenna is fed from the transmitter or transmission line. Added inductance, as explained earlier, has the effect of increasing the electrical length of the antenna, whereas capacitance decreases it. In this manner the antenna can be made to respond as though it has a number of quarter waves along its length. By tuning the antenna properly, the standing waves are increased and the radiated energy is increased.

In our study of transmitters in chapter 9, we will learn more about the antenna tuning procedure for a typical model of Navy shipboard transmitting equipment.