

BUSHIPS

NOVEMBER 1951

ELECTRON

NavShips 900,100

RESTRICTED

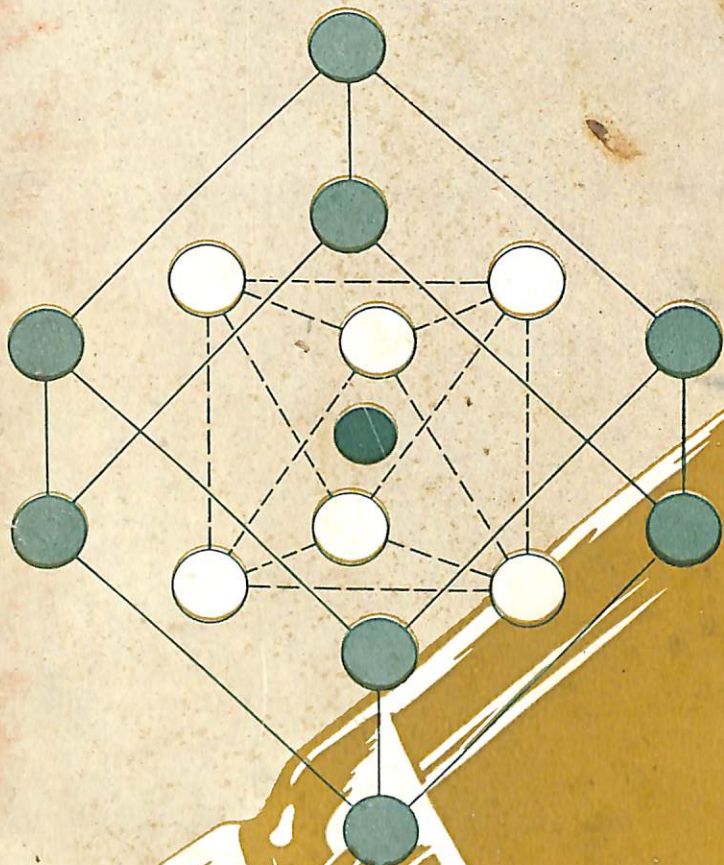

RESTRICTED

OCT 1951

IN THIS ISSUE

DIELECTRIC AMPLIFIER FUNDAMENTALS

Hilley

**THIS
ISSUE**

A
MONTHLY
MAGAZINE
FOR
ELECTRONICS
TECHNICIANS

<i>Dielectric Amplifier Fundamentals</i>	1
<i>The Field Engineer Sez</i>	20
<i>Shielding Attenuation</i>	22
<i>Modernization of Transmitting Antenna and Ground System, NAS, Lakehurst, N. J.</i>	24
<i>Servicing the AN/SGC-1 with a Minimum of Test Equipment</i>	26
<i>Can This be You?</i>	27
<i>Type 23496 Remote Channel Selector Indicator Unit</i>	27
<i>Model VF Oven Thermometers</i>	27
<i>Modernization F.C. Kit for the Model OZ</i>	28
<i>DBM-1 Antenna Rotation Failures</i>	29
<i>ESO Monthly Column</i>	30
<i>Status of NAVSHIPS 900,123, 900,116, 900,105 and EPIS</i>	31
<i>IN MEMORIAM—Mr. Abraham Cory</i>	31
<i>Reinsertion of R(2)75 in the SV/-1/-2</i>	31
<i>Error in F.C. No. 12—QCQ-2/QGB Bulletin</i>	31
<i>Letters to the Editor</i>	32

THE PRINTING OF THIS PUBLICATION HAS BEEN APPROVED BY THE DIRECTOR
OF THE BUREAU OF THE BUDGET 13 JANUARY 1950

DISTRIBUTION: BuSHIPS ELECTRON is sent to Department of Defense activities concerned with the installation, operation, maintenance, and supply of electronic equipment. If the quantity supplied is not correct, please advise the Bureau promptly.

CONTRIBUTIONS: Contributions to this magazine are always welcome. All material should be addressed to The Editor BuShips Electron, Bureau of Ships (Code 993-c), Navy Department, Washington 25, D. C. Whenever possible articles should be accompanied by appropriate sketches, diagrams, or photographs.

CLASSIFICATION: Most issues of BuSHIPS ELECTRON are classified restricted or confidential in order that information on all types of equipment may be included. Specific material published in any issue may or may not be classified, however. Each issue is assigned the highest classification of material included. Classified material should be shown only to concerned personnel as provided in U. S. Navy Regulations. Don't forget, many enlisted men are concerned with the contents of this magazine. BuSHIPS ELECTRON contains information affecting the national defense of the United States within the meaning of the Espionage Act (U.S.C. 50; 31-32) as amended.



DIELECTRIC AMPLIFIER FUNDAMENTALS

by

LCDR. A. M. VINCENT, U.S.N.
*Electronics Design and Development Division,
Bureau of Ships*

Introduction

The Bureau is investigating all types of devices that show indications of being a possible substitute for the electron tube, primarily in the interest of reliability. This article describes the principles of the dielectric amplifier. A previous article outlined the magnetic amplifier in relation to radio-frequency applications.

The electron tube is superb in performance, but it is a rather delicate device, extremely sensitive to overloads, and has a relatively short life. Over eighty-five percent of electronic equipment failures can be attributed to tube failures—with an increasing number of tubes used, and greater reliability of other components, the reliability of the equipment becomes more and more the reliability of the electron tube itself.

The dominating position of the electron tube in Naval electronic equipment is emphasized when it is realized that over 13,000 tubes are required on board an aircraft carrier, excluding plane equipments, which is almost identical to the amount of tubes used in a transcontinental telephone circuit between New York and San Francisco. Reliability is further emphasized since it has been determined that the cost of field maintenance of electronic gear is ten times the initial cost of the equipment.

In addition to the advantages of reliability, the dielectric amplifier is extremely compact, almost tailored to fit the miniaturization program in which the Bureau is also active. Miniaturization of equipment utilizing electron tubes is usually accomplished at the expense of reduced reliability, in that the ambient temperature is higher in miniaturization equipment since the power losses of



small tubes and components have not been reduced in proportion to the reduction of heat radiation surfaces.

The dielectric amplifier is an excellent device to supplement the magnetic amplifier in that it is a relatively high impedance device. It also requires the same type a-c power supply and rectifiers used in the magnetic amplifier.

These rugged devices have a life limitation that is determined by the life of the rectifiers used (if any). A rectifier's life is many times that of an electron tube. The body of the active dielectric, like that of the magnetic material used in the magnetic amplifier, does not deteriorate or age with use.

The dielectric amplifier is described in parallel with the magnetic amplifier for the following reasons: 1—the fundamental application and circuitry techniques of both devices are somewhat similar; 2—they are compatible in the same equipment; 3—they require the same type of specialized power supply; 4—a similar article on magnetic amplifiers, covering many applications applicable to the dielectric amplifier, has been included in the June and July 1951 issues of the *ELECTRON* and in the *NavShips* pamphlet "Magnetic Amplifiers, A Rising Star in Naval Electronics".

History

Dielectric amplifiers are relatively new, although the non-linear characteristics of certain dielectrics have been known for many years.

No one individual can be credited with the invention of the dielectric amplifier. The inherent non-linear characteristics of certain dielectrics naturally suggested their use in an amplifier. Many

types of dielectric material such as dihydrogen potassium phosphate arsenates, rochelle salt, tungsten trioxide, barium titanates, barium-strontium titanates, barium-lead, and lead zirconates, naming only a few, possess the desirable non-linear characteristics. Research is continuing into production of many different mixtures including compounds containing magnesium, beryllium, calcium, tellurium, sulphur, et cetera to produce other effects for special applications.

It is not known who actually discovered the occurrence of the ferro-electric effect in insulating material. Observations made as early as 1902 showed that single crystal structures of titanium dioxide had a dielectric constant change of two to one depending on whether the charge occurred along the principal axis or perpendicular to it. These scientists attributed this to axial density. In 1912 Debye of Holland determined the existence of electric dipoles which are bound to arise when atoms of different types which differ in electron affinity form molecules. Valasek of the United States identified certain material as ferro-electric as early as 1921, followed in 1935 by Busch and Scherrer of Switzerland who enlarged the field and also mentioned the salient amplification features of some of these dielectrics.

The unusual dielectric properties of barium titanate were discovered by Wainer and Salomon

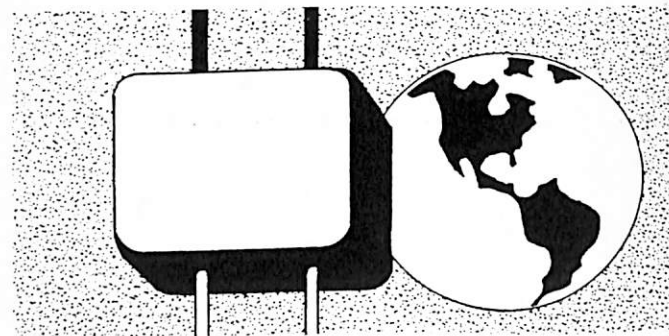

in 1942. Commercially, the first titanate compositions were made the latter part of 1942 in the United States. Shortly thereafter, the Massachusetts Institute of Technology under contract with Naval Research and Invention (Office of Naval Research) undertook the development of circuitry. Excellent amplification features were found, but due to inconsistency of results and lack of understanding of the material, circuitry was dropped and research on the basic material initiated. Carnegie Tech independently developed circuitry in 1948 and 1949 and also found excellent amplification, but a lack of uniform material; therefore they dropped

the project. With the further development of basic material, Carnegie Tech under a 1951 contract with ONR is again developing circuitry. Other branches of the armed services and private industry have been developing dielectrics independently of the Navy.

VonHippel, Roberts, and Breckenridge are generally accepted as the first to apply the barium titanates in an amplifier. Dr. Roberts developed circuitry for dielectrics while working on his doctors degree prior to 1946. This was accomplished during World War II as a part of a research contract on dielectric materials supported in part by the Office of Naval Research.

Ceramics have always intrigued the condenser manufacturers because of their extremely high dielectric constant of up to 10,000 compared to around 6 for glass and 7 for mica. This dielectric has been used in miniature postage type condensers for several years. One of the drawbacks of ceramics was the non-linear characteristics of this material which limited their use in conventional applications. A tremendous amount of research has been done in an attempt to reduce the non-linear characteristics of these dielectrics. Since ceramic dielectric condensers will also be used for

considered an amplifier, if a small stream of water operates a larger valve in the main line.

Electrically the device can be compared somewhat to that of an electron tube, in that the grid of the tube controls a relatively large amount of plate power. In a dielectric amplifier, power is varied, like the water valve and the tube, by inserting the device in series with the load to be controlled. Control is then accomplished by varying this impedance, which increases or decreases the power to the load. The impedance to the flow of AC is effected by changing the degree of dielectric saturation with a relatively small amount of DC, or properly phased AC, through a separate control voltage on the same or auxiliary plates. An unsaturated dielectric has a relatively low impedance to AC. A saturated dielectric acts effectively as a dielectric of lower dielectric constant with more impedance thereby reducing the flow of AC to the load.

Figure 1 illustrates the principle of operation. With the dielectric completely between the plates, the impedance to the flow of AC is low, permitting a considerable amount of current to flow through the load. Pulling this dielectric out reduces the

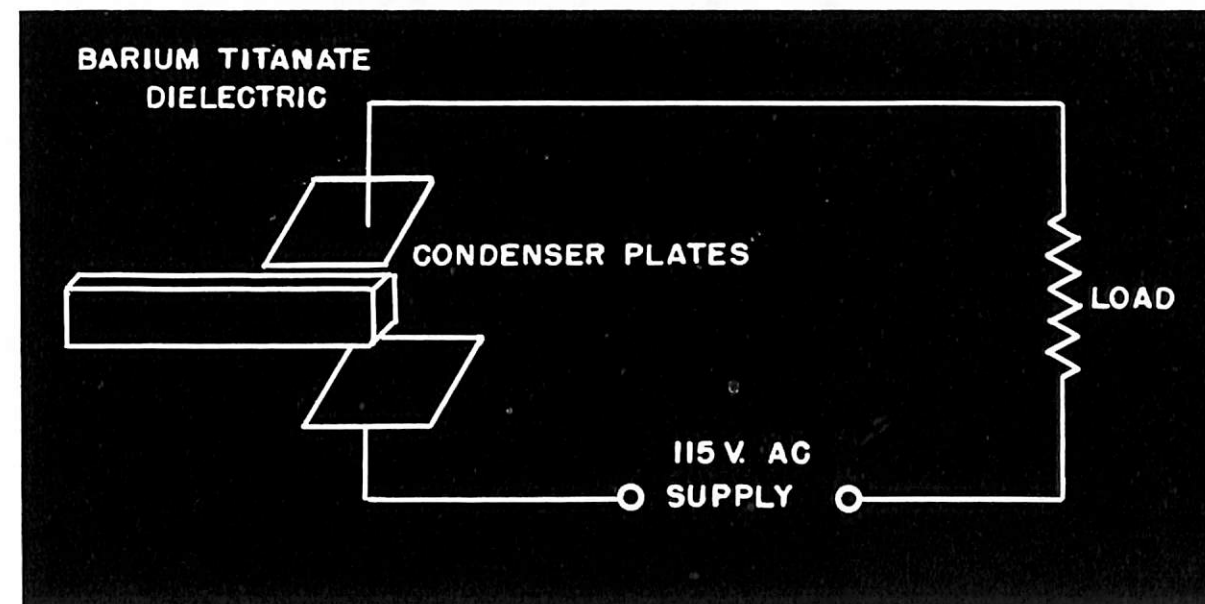

FIGURE 1—Principle of operation of dielectric amplifiers.

linear applications, research is now going on towards developing both the linear and non-linear characteristics.

Fundamentals

A dielectric amplifier is simply another type of control valve. A valve in a water line can be con-

capacity of the condenser as the dielectric constant of the solid dielectric is greater than that of air, which progressively reduces the voltage across the load. Since the control power is less than the power controlled, the device is an amplifier—being controlled by a change of dielectric constant, it is called a dielectric amplifier.

Technically the function of a dielectric amplifier is to control the a-c reactance of a condenser by a relatively low input voltage. The condenser is in series with the load thus changing the load current.

The sketch in Figure 1 is drawn primarily to illustrate the principles of operation, and does not exactly comply with the description in the previous paragraphs as in this instance the dielectric is being replaced by air. In conventional applications the impedance effects are controlled by changing the dielectric constant of a stationary dielectric by controlling the permittivity of the material by a superimposed input voltage.

Certain dielectric materials have hysteresis loops that are very similar to those of magnetic material. The hysteresis loops in the magnetic material are formed because of the magnetic fields within the material. Therefore, those materials are said to exhibit the ferro-magnetic effect. Likewise, in di-

In other words, individual molecular displacements caused by voltage strains tend to change the permittivity of the dielectric in certain ceramics which affects the material somewhat like the sponge's ability to absorb water in relation to various stages of presaturation. The bias partially saturates the sponge; the signal adds and subtracts to this saturation in accordance to input, which in turn regulates the load current.

This dielectric change in capacity causes a current change which is somewhat analogous to a venetian blind controlling a stream of light. A steady flow of light could be modulated by changing the angle of the slats in accordance to a sine wave. When the slats are wide open, parallel with the beam of light, a maximum light would pass. In this wide open position, the ratio of light change to slat movement would be small, resulting in low sensitivity because we are working on the flat part of the curve. Now if we bias these slats

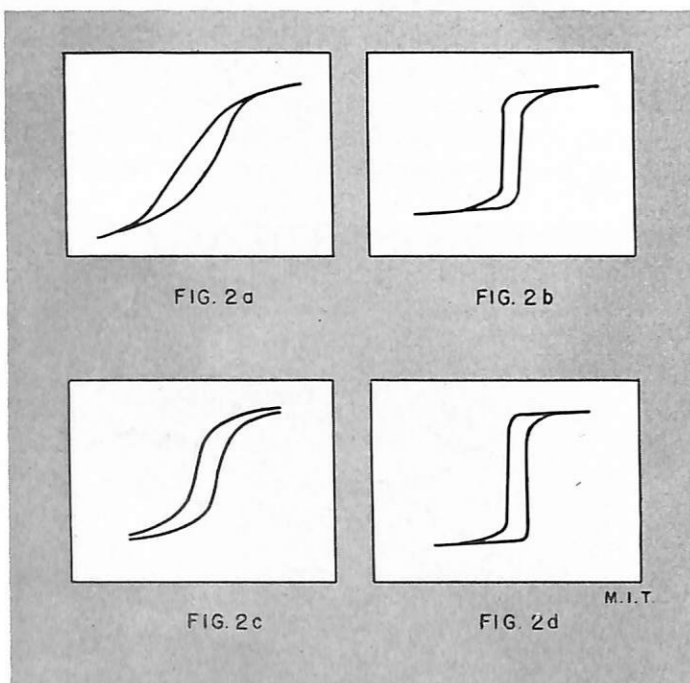

FIGURE 2a—Hysteresis loop of barium titanate before forming.

FIGURE 2b—Same as 2a, but after forming.

FIGURE 2c—Hysteresis loop of silicon steel, heat treated and cooled only.

FIGURE 2d—Same as 2c but cooled in a weak magnetic field.

electric material an electric field produces the hysteresis loops; thus, the dielectric exhibits a ferro-electric effect. This is rather confusing as dielectric amplifiers are often referred to as ferro-electric amplifiers, although no iron is involved.

The ferro-electric effect utilized in dielectric amplifiers involves the alignment of electric dipoles of atomic ions by mutual interaction in non-magnetic crystalline structures. Ferro-magnetic effects employed in magnetic amplifiers depend on the parallel orientation of electron spins of magnetic dipoles in magnetic material.

to, say 45 degrees, by tying them at that angle with a rubber band, our ratio of light to movement of slats will be considerably increased; or we can go a step further and shut off the light by tightening the rubber band to hold the slats vertical, then only one half of a reciprocal modulated movement would open the blind which would result in greater volume change. This would, however, require a second set of blinds to take care of the other half of the cycle, analagous to a push-pull stage.

Dielectric amplifiers are seldom operated at the cut off point because this cut off is not abrupt like

FIGURE 3—Dielectric constant curves for a variety of combinations of barium titanate and strontium titanate.

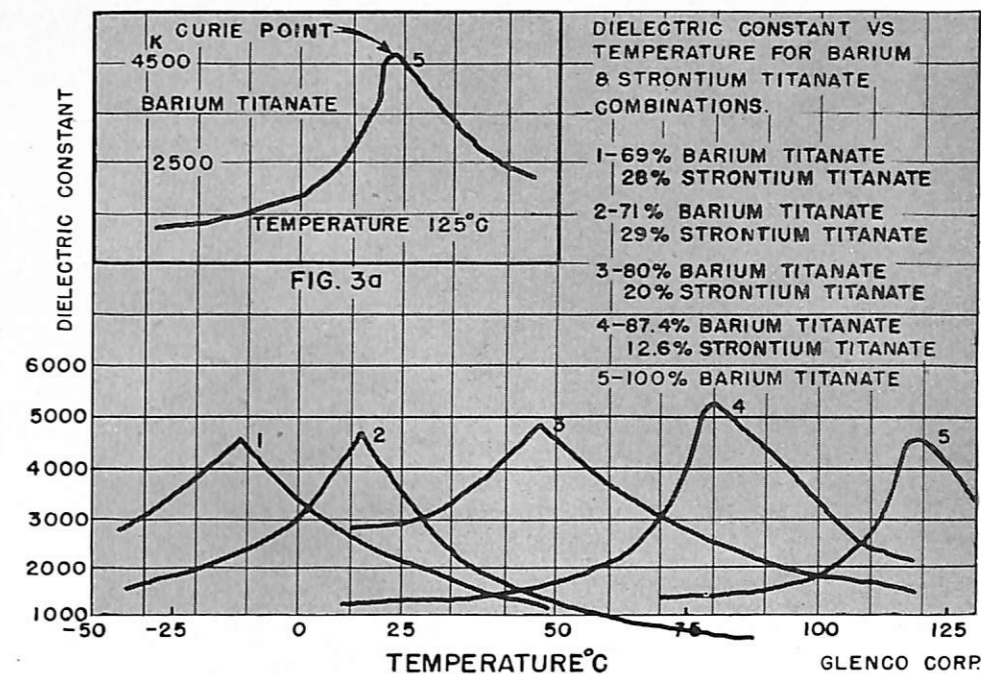

a magnetic or tube amplifier and, in addition, the strain caused by the bias, plus the signal voltage, would require that the capacitor be worked near the failure point.

Figures 2a and 2c show hysteresis loops of both the dielectric and magnetic bodies. These curves also show that both types of bodies respond somewhat alike to the forming treatments.

From the hysteresis loops of Figure 2 it is apparent that the dielectric material and the magnetic material have almost identical hysteresis characteristics. Figures 2a and 2b are the hysteresis loop of barium titanate. Figure 2a shows the loop before the forming treatment was applied while Figure 2b shows the loop after the forming treatment. The forming process of barium titanate is applied by systematically increasing the electrostatic field strength to the crystal through several heating cycles. Figures 2c and 2d are the hysteresis loop of silicon steel. In Figure 2c the silicon steel was heat treated and cooled only, while in Figure 2d the silicon steel was heat treated and then cooled in a weak magnetic field.

From this analysis one would think that the reactance characteristics of both the ferro-electric and ferro-magnetic material would respond somewhat alike to applied operating fields. This, however, is not exactly true as the operating curves deviate too greatly from the hysteresis curves, as indicated in Figure 16 and Figure 17. This is mainly due to the difficulty at the present time of

growing large titanate crystalline structures and still retaining the behavior of a single crystal. It is understood Harshaw Chemical Company is working on the project.

Flower pots, spark plugs, dishes, bricks, and kitchen sinks are all forms of ceramics but would not make good dielectrics. The barium titanate compositions that are commonly used today are a synthetic crystalline material which has a dielectric constant, $K=1500$ to $10,000$ at the Curie points. The Curie point is the temperature point where the dielectric constant passes through a maximum. As can be seen by the curve of Figure 3a, the dielectric constant of barium titanate changes very appreciably with temperature changes.

It is possible to shift the Curie point to lower and lower temperatures by adding increasing amounts of strontium titanate with barium titanate, et cetera. Curves for a variety of combinations of strontium titanate and barium titanate are shown in Figure 3.

The ceramics used in the non-linear dielectric capacitors are hard, similar to porcelain, thus durable and have the ability to withstand high temperature (1000°C). The ceramics can be machined accurately and made into a variety of shapes and sizes. The present titanates have a breakdown voltage of the order of 50 V/mil at room temperature.

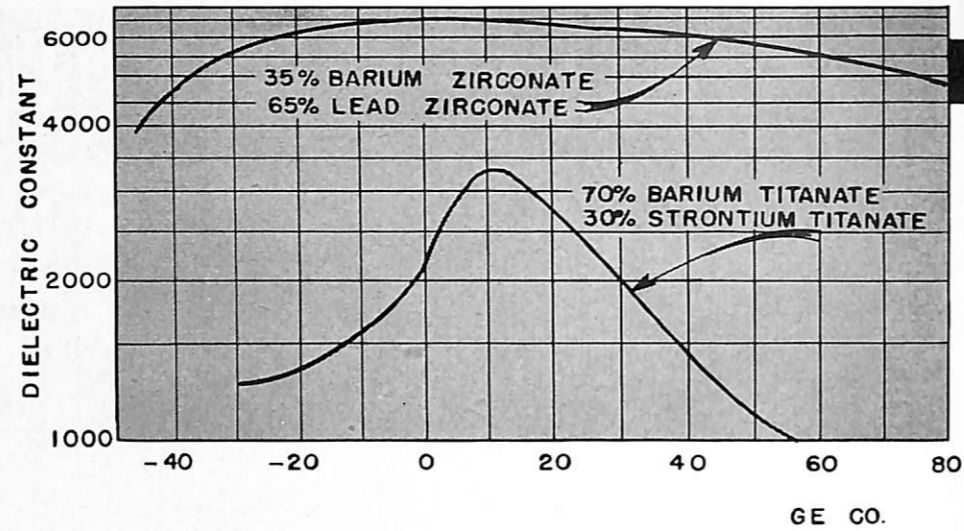

FIGURE 4—Temperature vs. dielectric constant curve for barium-lead-zirconate.

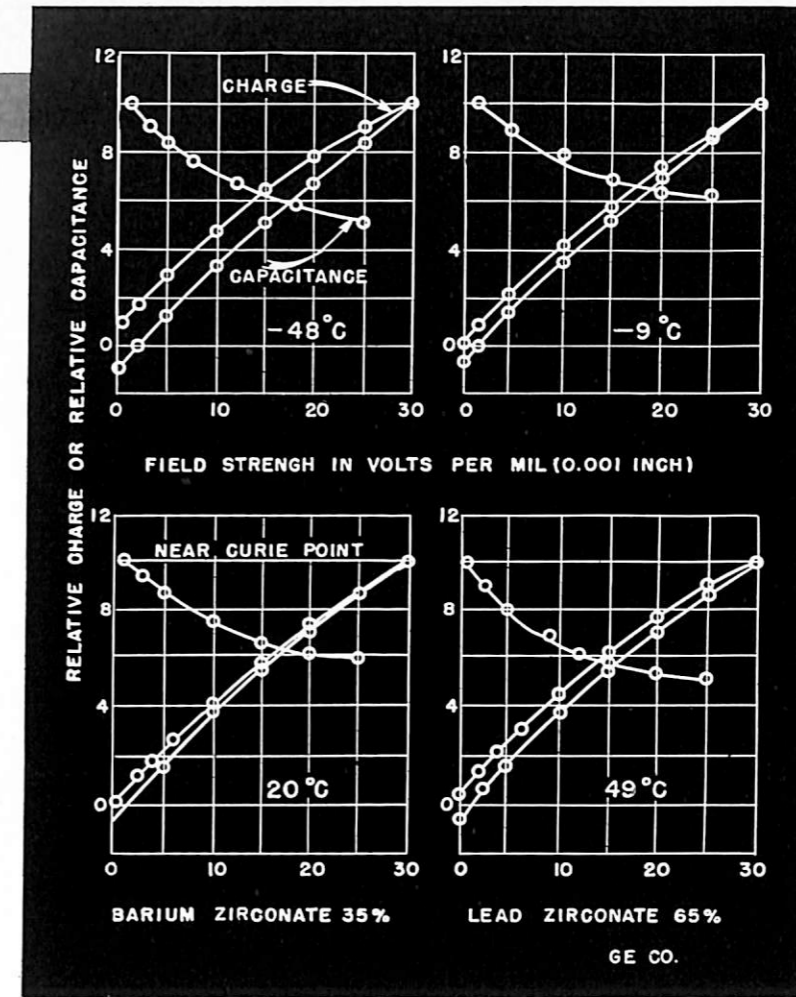

FIGURE 6.

The Curie point is a major consideration, when working with ceramics, as the greatest gain is obtained very near this point. If this varies with temperature, it follows that the gain is also affected. Amplifiers are designed to work on the steep slope just above the Curie point because the negative side is usually less stable due to the greater piezo-electric effects, time constants, drift, hysteresis loss, et cetera, as indicated in Figure 5. In circuit applications where low hysteresis is important, titanates should only be worked above the Curie point.

The apparent disadvantage of the Curie point variations is not as serious as one would think since the negative slope can be used in spite of its deficiencies for compensation purposes. Two dielectrics could be used, one operating on the positive side of its Curie point and the other operating on the negative side to compensate for each other over small temperature ranges. In addition to the above a temperature control can be used. The same ceramic material used in the amplifier could

be used as the sensitive element of a thermostat to maintain a constant temperature. Another thing that reduces the temperature stabilization problem is that the Curie point can be made to appear at different temperatures by changing the composition of the material to suit prevailing conditions as indicated by Figure 3.

Some materials however do not depend on the Curie point operation. Barium-lead-zirconate is an example. Figure 4 shows the temperature versus dielectric curve of this material. It will be noticed that this material has a high dielectric constant comparable to the titanate compositions. The lead zirconate compositions have a slightly lower possible gain, but a more stable gain than the titanate combinations as can be seen from Figures 5 and Figure 6. Indications are that lead zirconate compositions will be used in many applications now dominated by the titanates, particularly where stability is important.

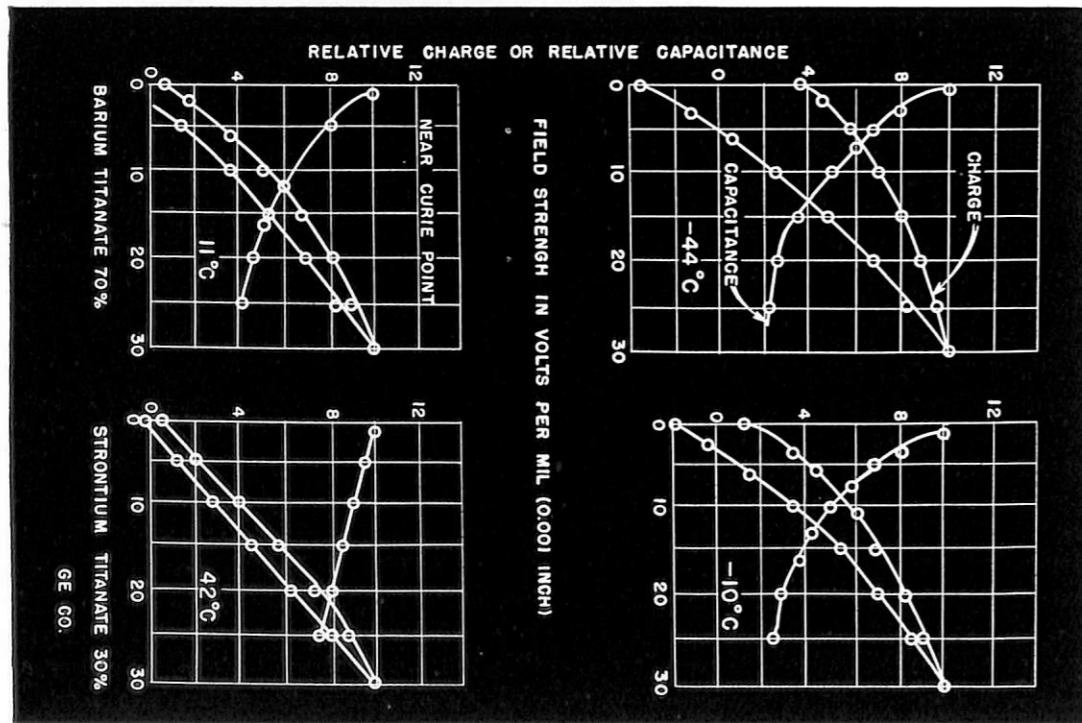

FIGURE 5.

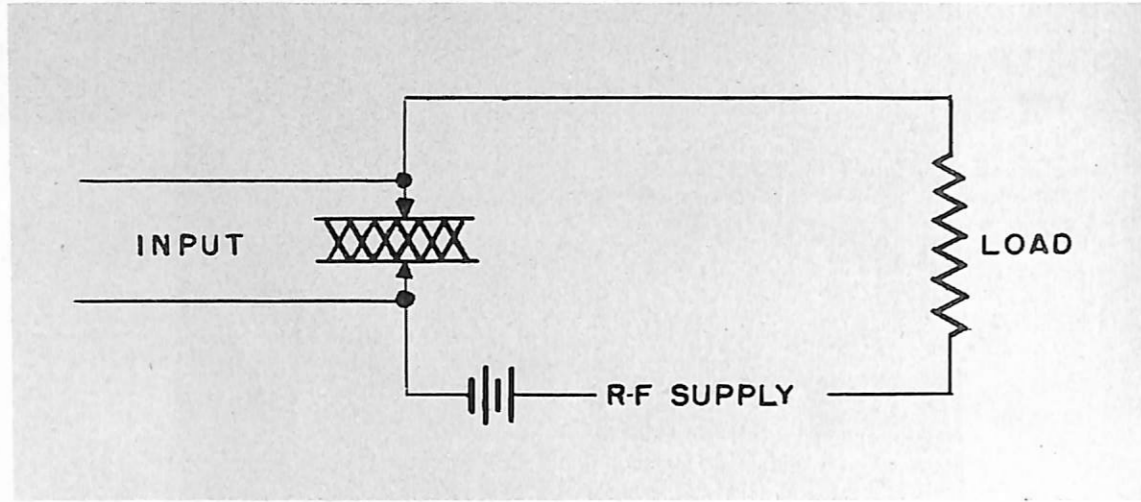

FIGURE 7—Basic principle of using the dielectric condenser as an amplifier, by placing it in series with the load to be controlled.

Circuitry

Figure 7 shows the basic principles of using the dielectric condenser as an amplifier. The non-linear dielectric like that of the saturable reactor and tube (Figure 8 and Figure 9) is simply placed in series with the load to be controlled. An alternating-current power supply of at least three times the frequency of the signal to be controlled should be used as a source of power. The power supply normally used is a tube oscillator equivalent in size

and power to the rectifier tube used in an electron tube receiver.

Figure 10 is a basic circuit using two non-linear and two linear capacitances. The effective gain of the amplifier is reduced by the linear capacitances in the circuits. However, from the standpoint of balancing the circuit the capacitances are necessary.

A push-pull arrangement of the basic circuits is shown in Figure 11.

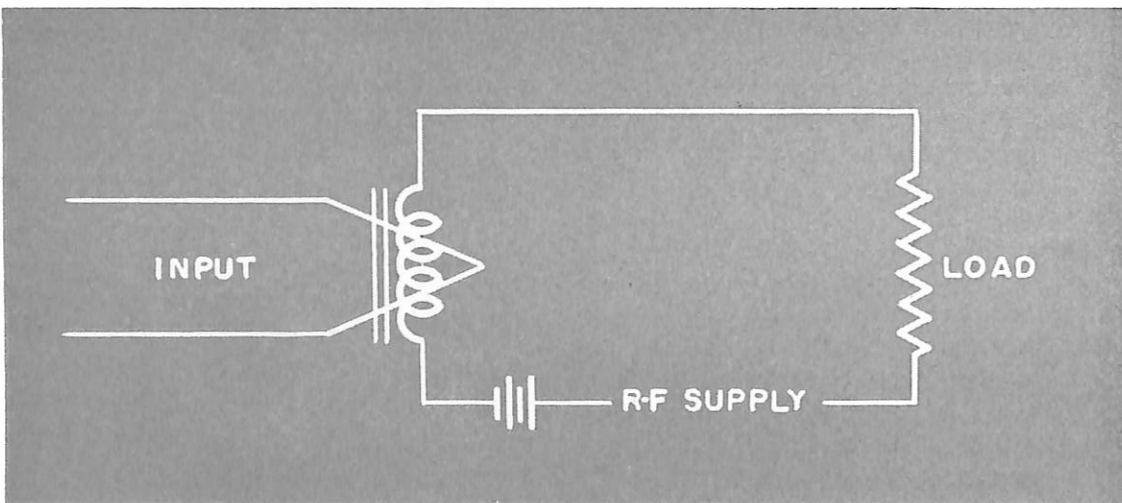

FIGURE 8—Saturable reactor used as an amplifier.

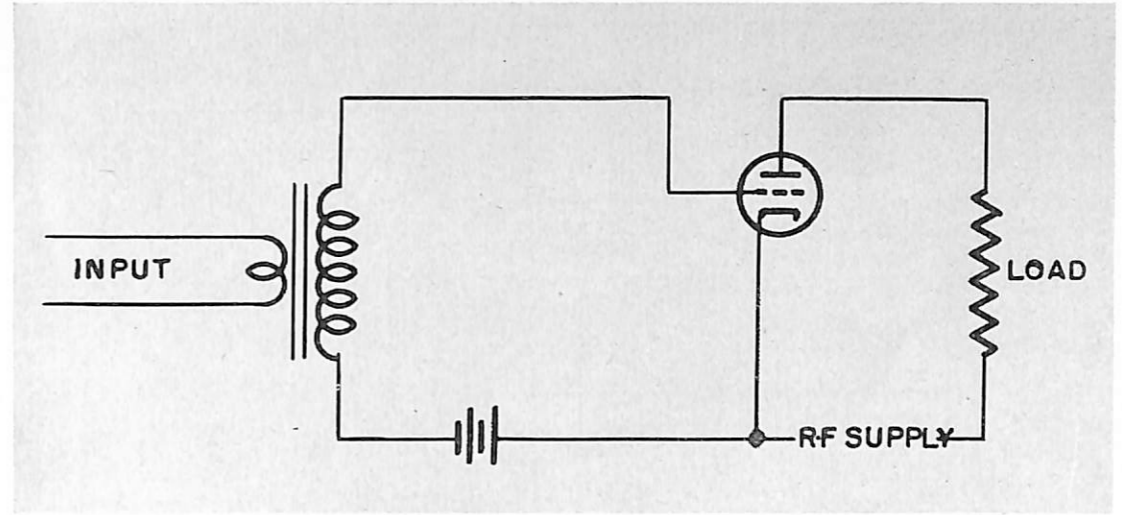

FIGURE 9—Electron tube used as an amplifier.

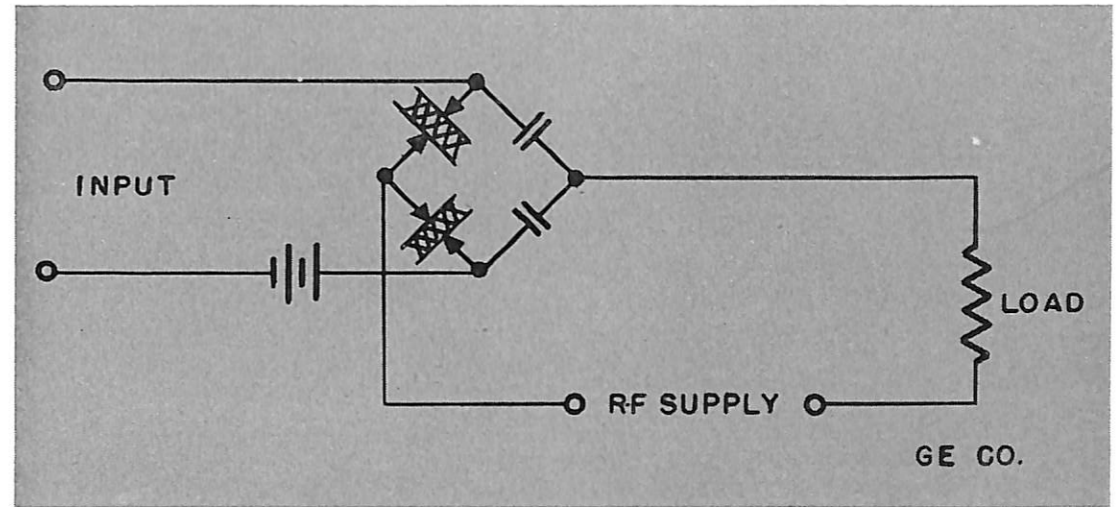

FIGURE 10—Basic circuit using two non-linear and two linear capacitances.

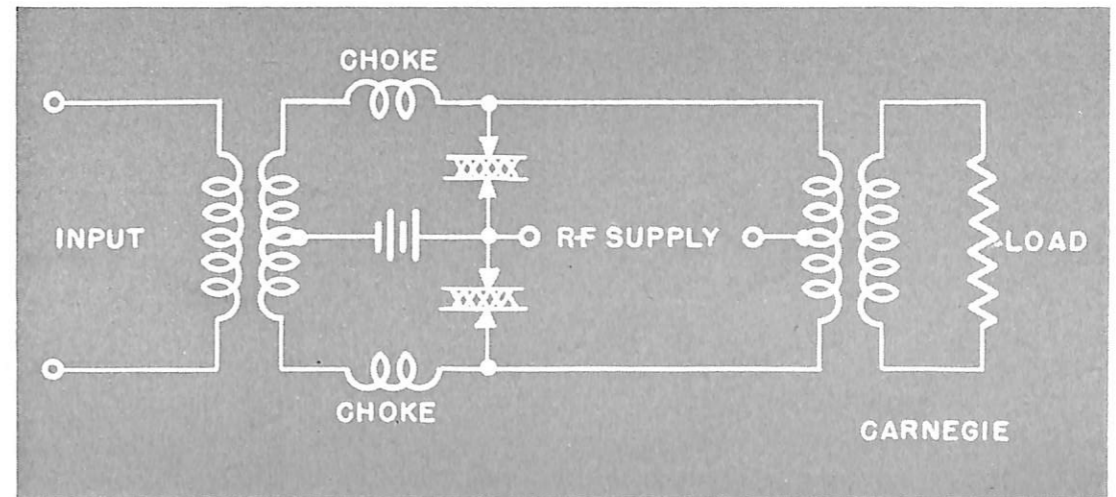

FIGURE 11—A push-pull arrangement of the basic circuits.

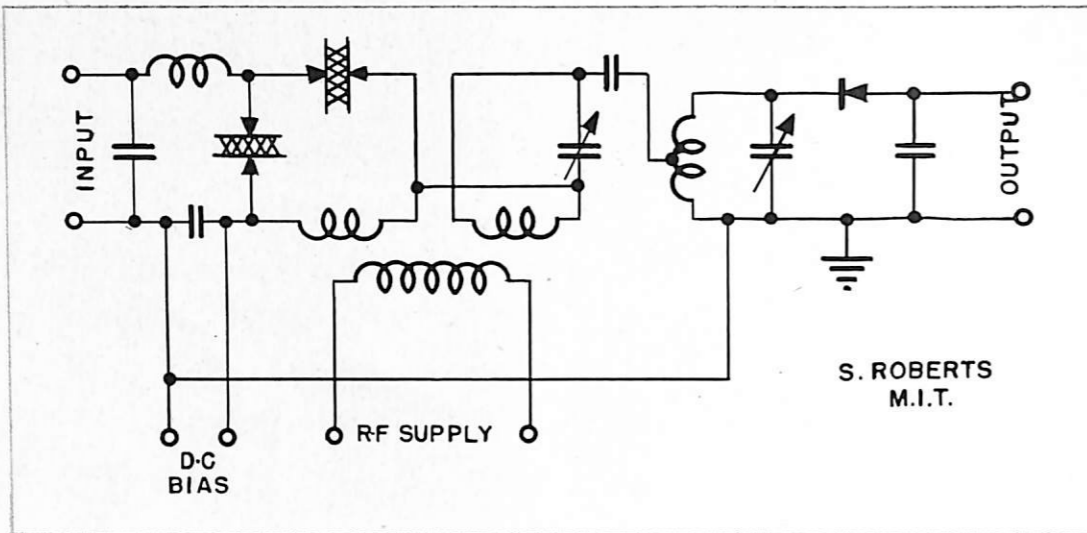

FIGURE 12—Practical dielectric amplifier using r-f power supply.

Figure 12 and Figure 13 are practical amplifier circuits using radio-frequency power supplies. The circuit in Figure 13 has a power gain of 15 at 4000 cps. The voltage gain per stage would of course include any gain realized by a load transformer. Figure 14 shows oscillograms of wave forms which were obtained from the circuit in Figure 13.

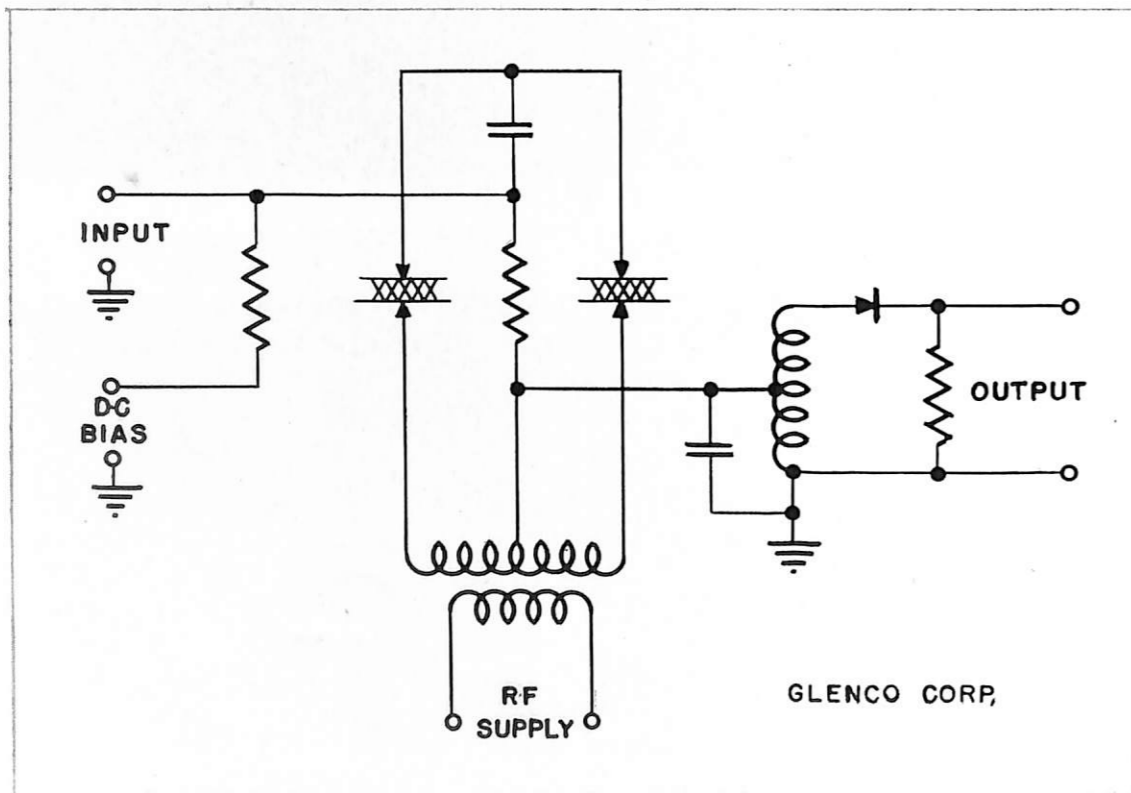

FIGURE 13—Practical dielectric amplifier with a power gain of 15 at 4000 cycles.

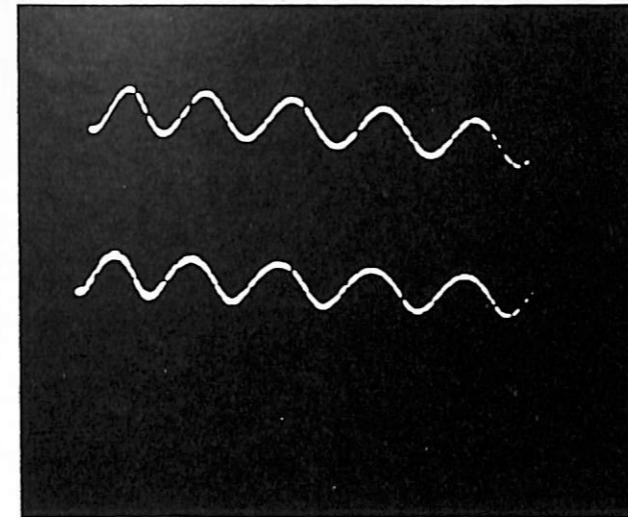

FIGURE 14a—Input 500 cy. 2 volts rms, 130 v. d-c bias.

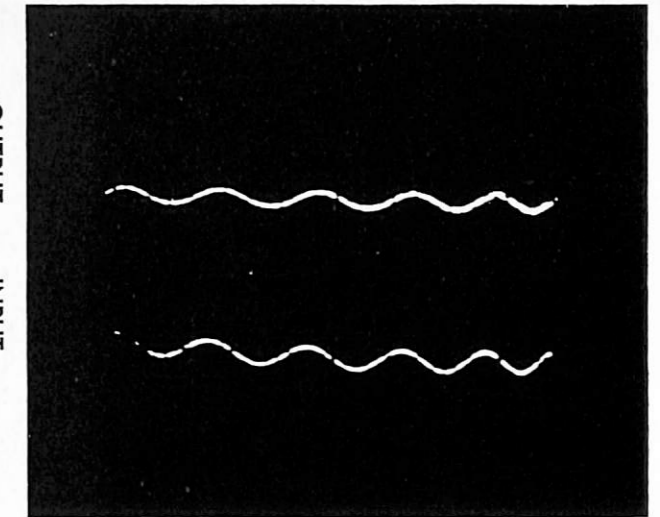

FIGURE 14b—Input 5000 cy. 1 volt rms, 130 v. d-c bias.

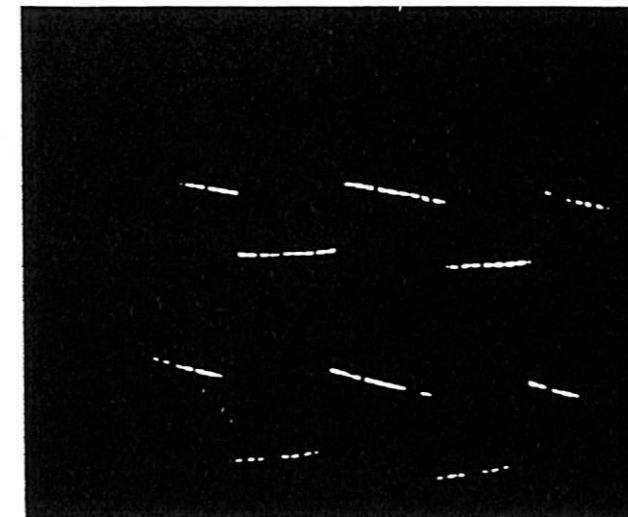

FIGURE 14c—Input 200-cy. sq. wave 5 v., 130 v. d-c bias.

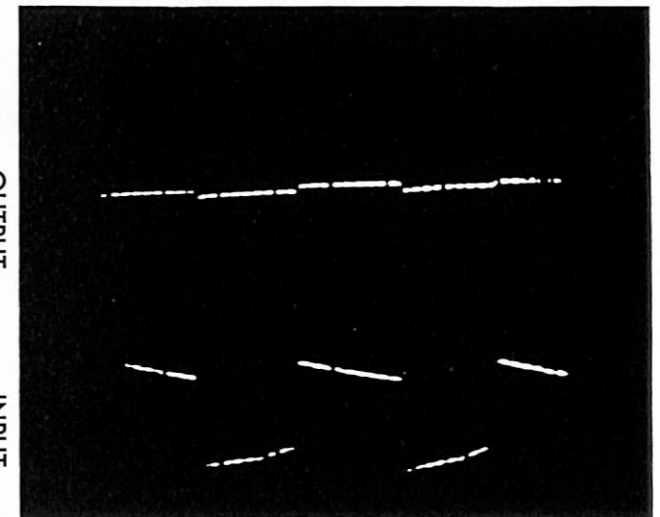

FIGURE 14d—Input 200-cy. sq. wave 5 v., 0 v. d-c bias.

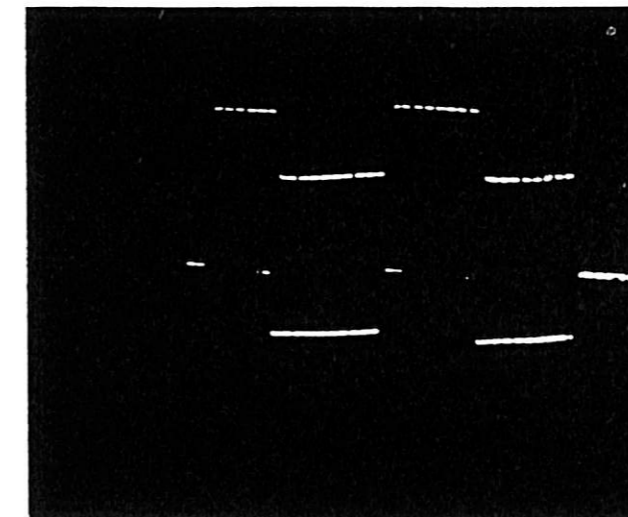

FIGURE 14e—Input 500-cycle sq. wave 5v., 130 v. d-c bias.

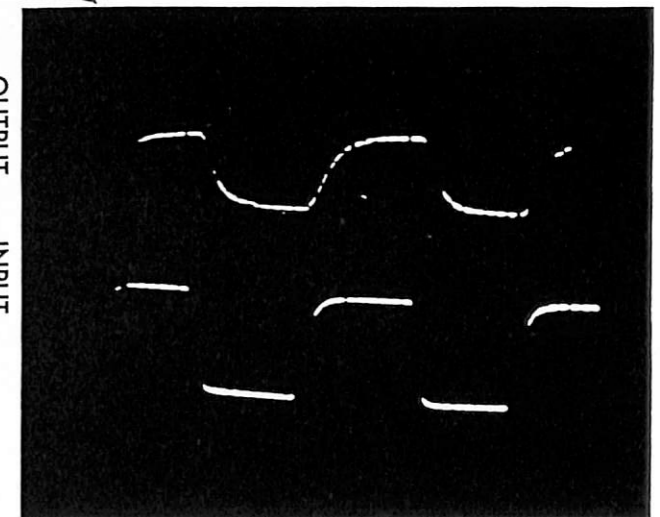

FIGURE 14f—Input 5000-cy. sq. wave 5 v, 130 v. d-c bias.

FIGURE 14—Oscillograms of dielectric amplifier wave forms.

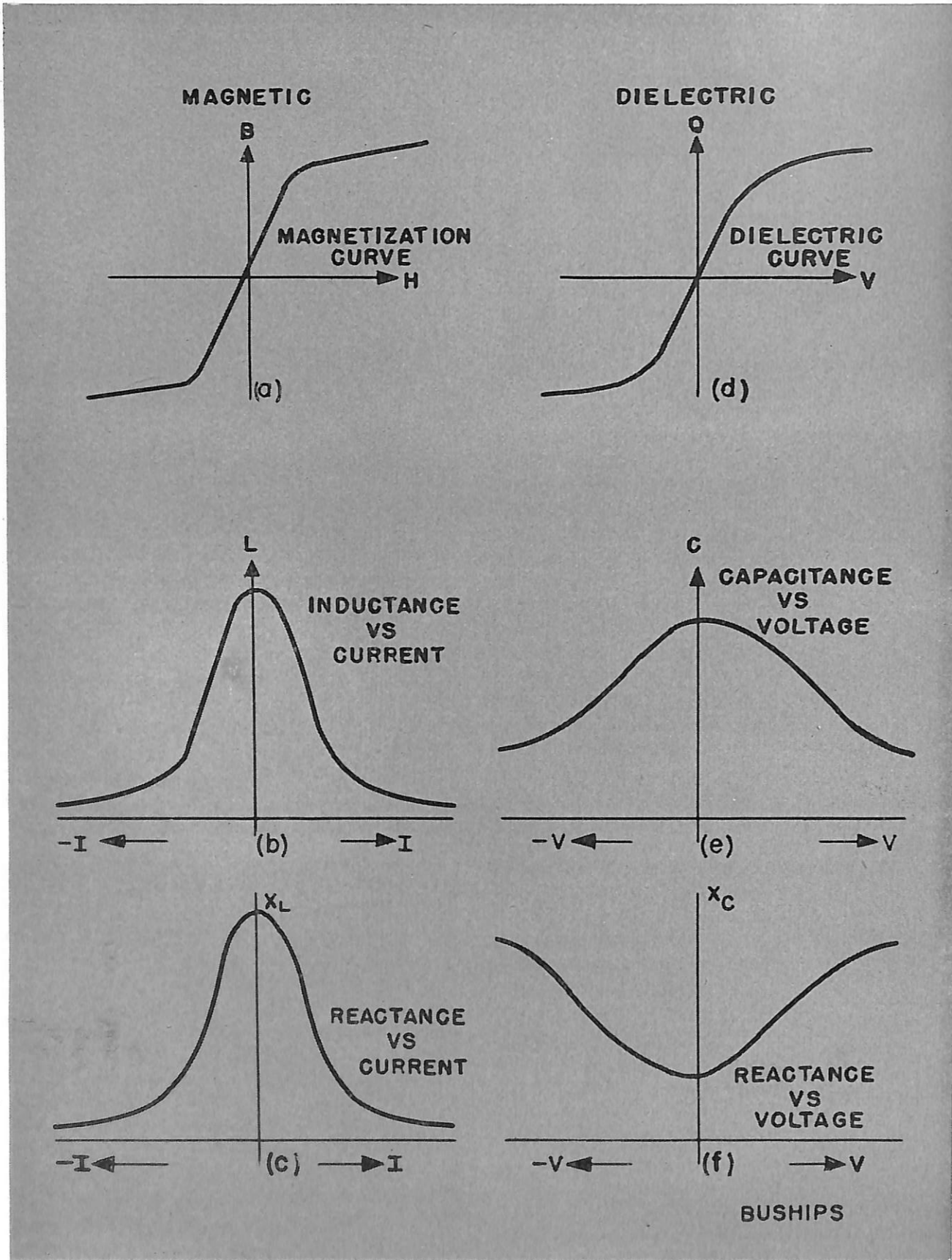

FIGURE 15—Idealized characteristic curves of both magnetic and dielectric materials as applied to amplifiers.

Figure 15 shows idealized characteristic curves of both magnetic and dielectric materials as applied to amplifiers. From Figure 15a and Figure 15d it can be seen that the basic curves are of the same general form. The amplifying properties of both dielectric or magnetic materials depend upon the changes of capacitance and inductance. These changes are shown in Figure 15b and Figure 15e. The change of capacitance and inductance changes the reactance. Figure 15c and Figure 15f show that the dielectric and magnetic characteristics differ with relation to their respective impedance versus input. As the input to the magnetic amplifier increases, the reactance decreases while in the dielectric amplifier the reactance increases as the input is increased. This fact causes the simple magnetic and dielectric amplifiers to be out of phase by 180° . Figures 16, 17, and 18 show transfer characteristic curves of the dielectric, magnetic, and tube amplifiers for comparison. With zero bias, the operating point of Figure 16 would be the low impedance point as indicated by Point B; in Figure 17, the magnetic amplifier (without self saturation), the zero bias would be at Point A at the high impedance point; whereas the tube would have zero bias at "B", the low impedance point. Under the above conditions, all three amplifiers would function differently. Only the tube amplifier would reproduce a sine wave in its original form. To do this with the tube, the grid source would have to be well regulated as the grid would be drawing current in the positive region. Biased at the zero point, both the dielectric and the magnetic amplifier would act as frequency doublers; their action however would be 180 degrees out of phase with one another with the same bias. This doubling action is illustrated in Figure 19 for the dielectric body. The response of the magnetic material would be somewhat along the same lines. The fact that the dielectric and magnetic amplifiers are out of phase is often used to obtain single stage inversion.

To compare the three types of amplifiers on an equal basis would require that a bias be added to shift the operating point to the center of the curves for class "A" operation as indicated by Point M (Figures 16, 17, and 18). To further equalize the comparison, the plate supply of the tube should also be AC as the other two devices will not work with DC. Further development would then follow along conventional class "A" amplifier analysis.

A further increase in efficiency and fidelity would result by operating the amplifiers at cutoff, Point A. A half wave replica of the exciting sine wave would result. This would be satisfactory for most

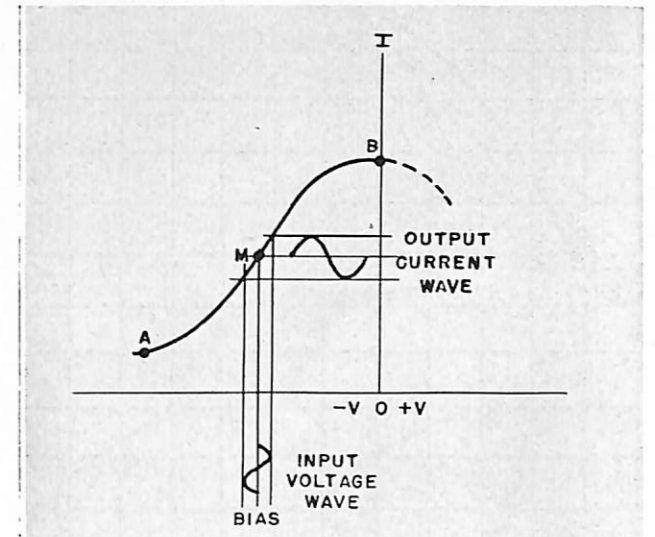

FIGURE 16—Transfer characteristic curves for a dielectric amplifier.

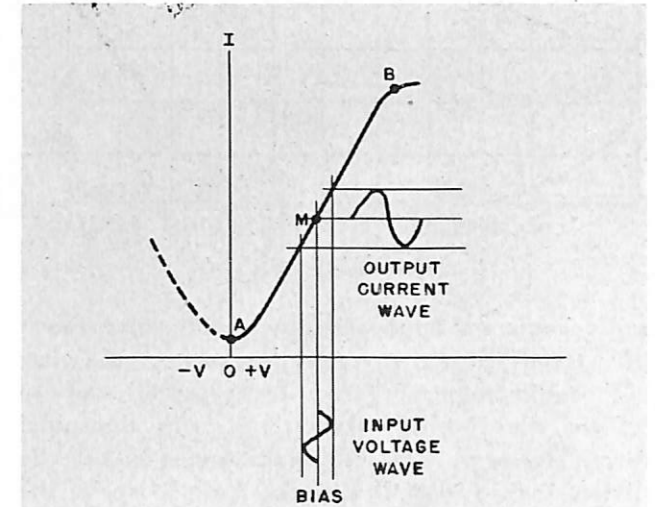

FIGURE 17—Transfer characteristic curves for a magnetic amplifier.

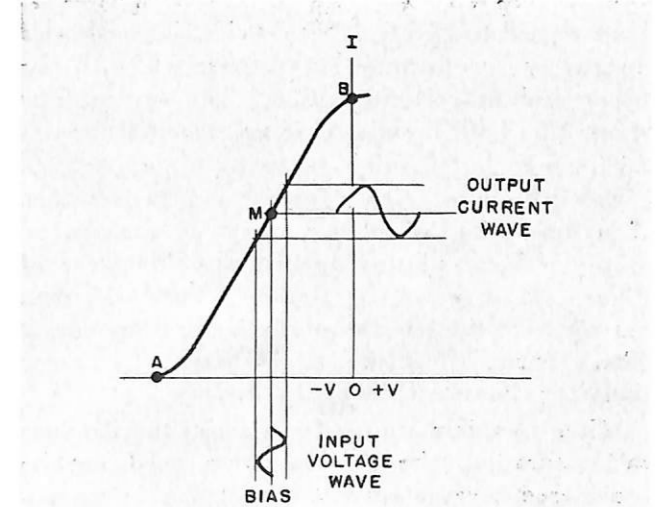

FIGURE 18—Transfer characteristic curves for a tube amplifier.

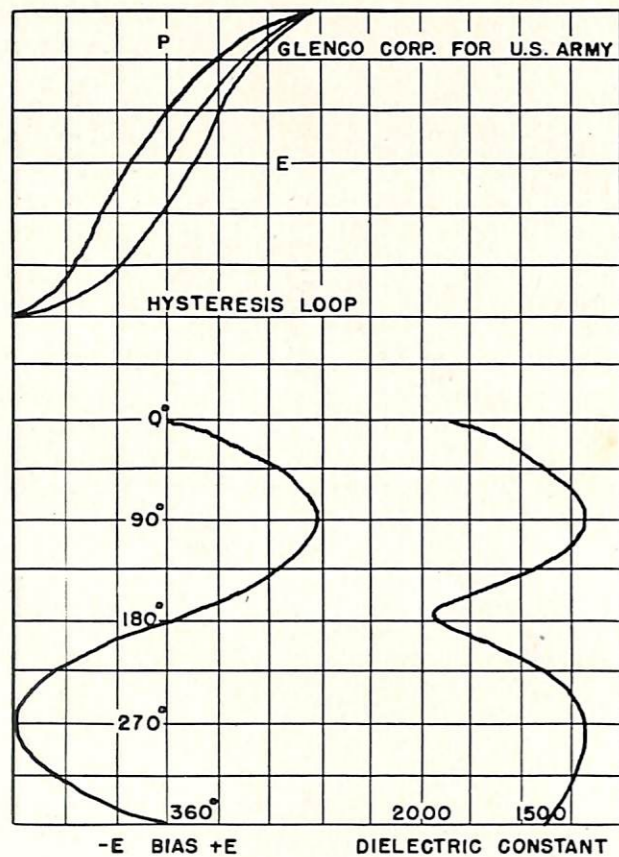

FIGURE 19.

radio-frequency applications as the fly wheel effect of a tuned circuit, somewhat analogous to a class "C" radio-frequency amplifier, would tend to reform the lopsided wave back into sinusoidal form. However, most engineers prefer to use the dielectric in push-pull, utilizing both halves of the wave. Regeneration, inverse feedback, et cetera can be used to modify the performance like any other amplifier.

In regard to Figure 16 the dielectric was biased negatively for purposes of comparison with the tubes and magnetic amplifier. The broken line shows that both the dielectric and magnetic amplifiers could be operated with an opposite bias. Figure 19, lower right, further emphasizes this. If a zero bias inductance curve of a magnetic amplifier were plotted against the sine wave of Figure 19, it would be similar to the dielectric curve except the lobes would be more pronounced. These curves illustrate the inherent frequency doubling characteristics of the devices.

When rectifiers are used in circuits to introduce self saturation, the reverse curve need not be considered because current cannot flow in the opposite direction.

Figure 20 shows a dielectric constant versus

voltage curve of a titanate body currently in production. This titanate was operated at 25 degrees centigrade just to the right of its Curie point. It will be noted that the dielectric does have a tendency to flatten or saturate if enough bias is applied. This makes it possible to work the dielectric as a biased class "C" amplifier. It should be noted that the maximum change of the dielectric in Figure 20 was only 5 to 1, but bodies mixed to further emphasize the non-linear qualities have a dielectric constant ratio of 10 to 1 or better.

Miscellaneous

Dielectrics exhibiting the ferro-electric effect have many uses other than being incorporated in an amplifier. One of these applications is amplitude modulation, Figure 21. Figure 22 is a simple thermometer with the ammeter as the calibrated scale and the capacitor as the temperature sensitive device. Dielectrics can be incorporated in thermal units because of their sharp Curie point. Other applications are in frequency modulation, Figure 23, and for remotely tuning LC circuits, Figure 24.

Barium titanate combinations have demonstrated possibilities of use in memory or storage circuits. When a single pulse signal is applied to these compositions the dielectric constant changes and

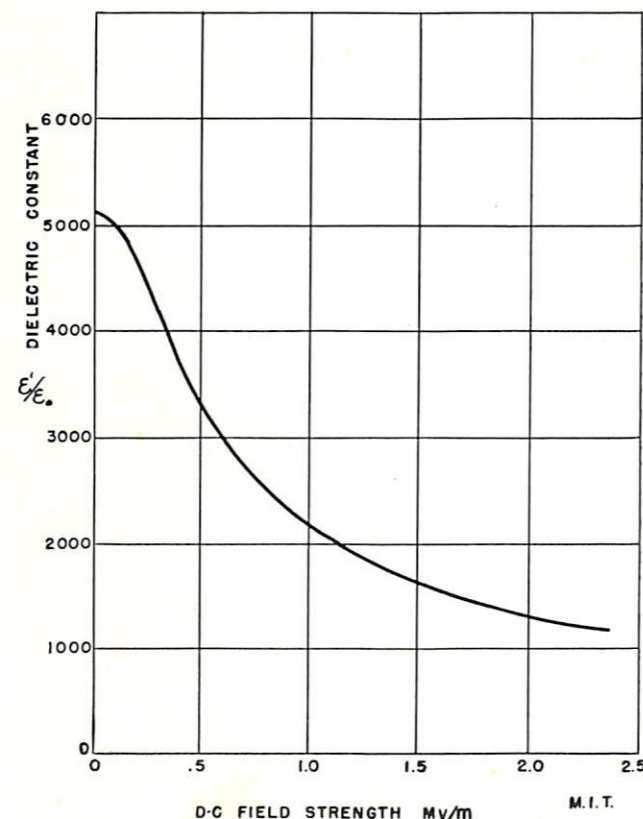

FIGURE 20—Dielectric constant vs. voltage curve for a titanate body currently in production.

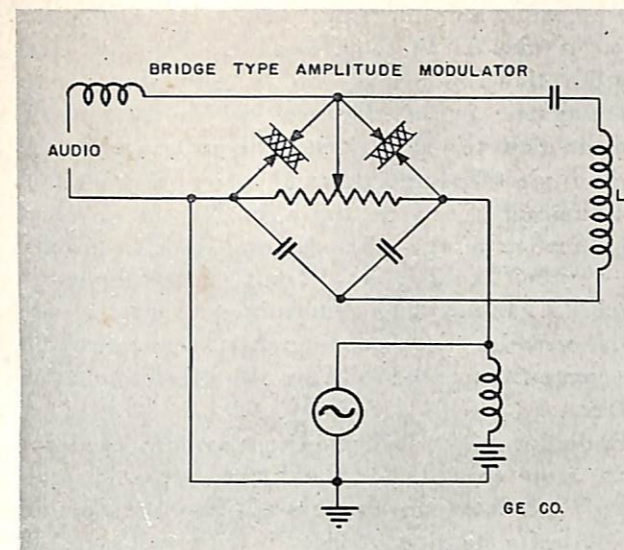

FIGURE 21—Dielectric used as an amplitude modulator.

will remain changed for several minutes. Also a piezo-electric condition will temporarily be noticed in the above materials which could perhaps be utilized in computer applications.

Besides titanates, Rochelle salt crystals also exhibit ferro-electric properties, but the range of the Rochelle salt crystals is rather narrow to be used as a direct amplifier; however, they are sometimes used in combinations with the titanates to emphasize the excellent piezo-electric effects encountered in the former, somewhat along the lines as illustrated in Figure 25.

The combination effects of resonance, both mechanical and electrical, are also utilized together with the piezo-electric and magnetostrictive qualities of titanate alone, to function as high gain high selective resonators in filter circuits.

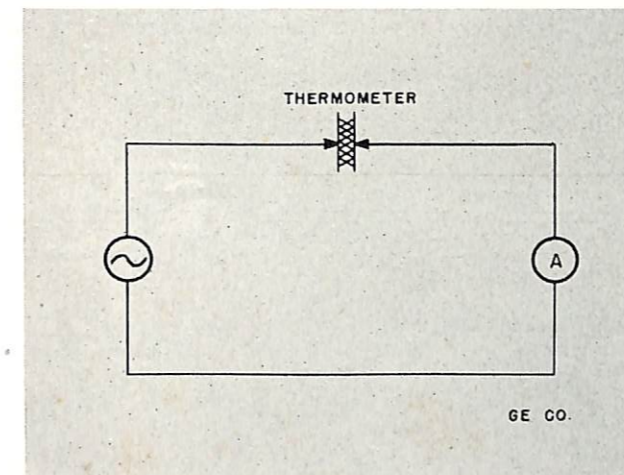

FIGURE 22—Dielectric used as a thermometer.

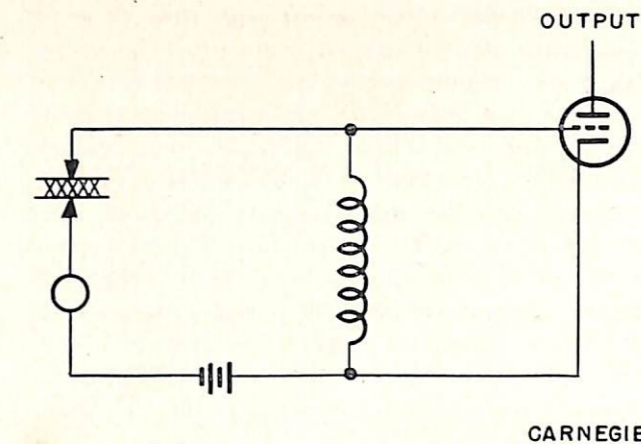

FIGURE 23—Dielectric used in frequency modulation.

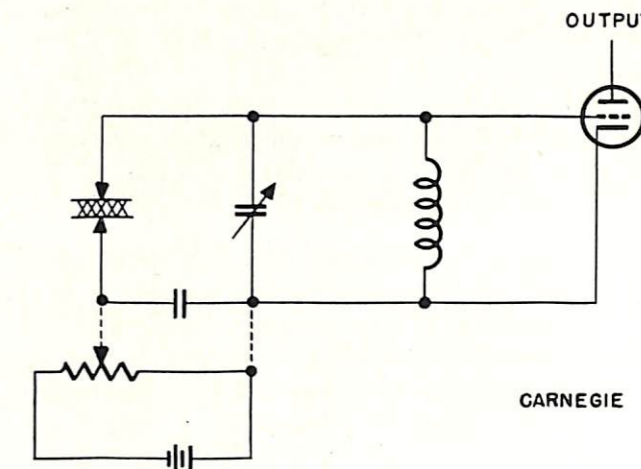

FIGURE 24—Dielectric used for remotely tuning LC circuits.

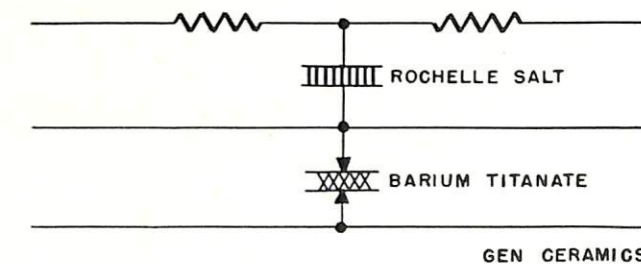

FIGURE 25—Rochelle salt crystals are sometimes used in combination with titanate.

Figure 26 shows resonance peaks in the curve of capacitance plotted against frequency. The graph also shows a rather pronounced resonant dip (low capacity) just beyond 10^7 cycles which may indicate possible radical, or unreliable performance beyond that frequency. A different size or type of dielectric changes this curve considerably. Impurities also enter into the picture. This curve was plotted several years ago, using dielectrics designed for standard condensers. This was also plotted with capacity measuring equipment attached which may have reflected some of the isolating radio-frequency choke characteristics. Later research does, however, bear out the fact that there may be a crystalline resonating period somewhere in the high frequency end of this curve using currently available titanates which may determine the upper operating limits.

General Comments

The dielectric amplifier is basically a high impedance voltage amplifier, the magnetic amplifier a relatively low impedance device, while the tube can be designed for either.

Because the tube can be designed for both high and low impedances, it would normally be superior to either amplifier in most applications. It is obvious from the above that neither the dielectric

nor magnetic amplifiers have the versatility of the electron tube. All three devices have their low level amplification limitations—the tube by shot noises, the magnetic by barkhausen and thermal noises and the dielectric by molecular disturbances caused by both electrical and thermal action. Barkhausen and thermal effects do limit the low level signal amplification of the magnetic amplifier to around 10^{-19} watts. The low level limit of the dielectric amplifier has not been determined to date as the basic ceramics vary considerably, depending on the compositions used to bring out different characteristics.

Preliminary tests indicate the magnetic amplifier to be more suitable for the lower frequencies although laboratory magnetic amplifiers are now on life tests functioning at 200 kc with gains of 150 per stage, excluding gains realized in the load circuit. Other tests with smaller gains are being made at 1 Mc.

Laboratory breadboard amplifiers, using presently available dielectric materials, show power gains up to one million per stage, with indications of a possible upper frequency limit of around 10 Mc. This material does, however, respond to modulations up to 3000 Mc.

It must be understood, however, that these devices are in about the same stage of development

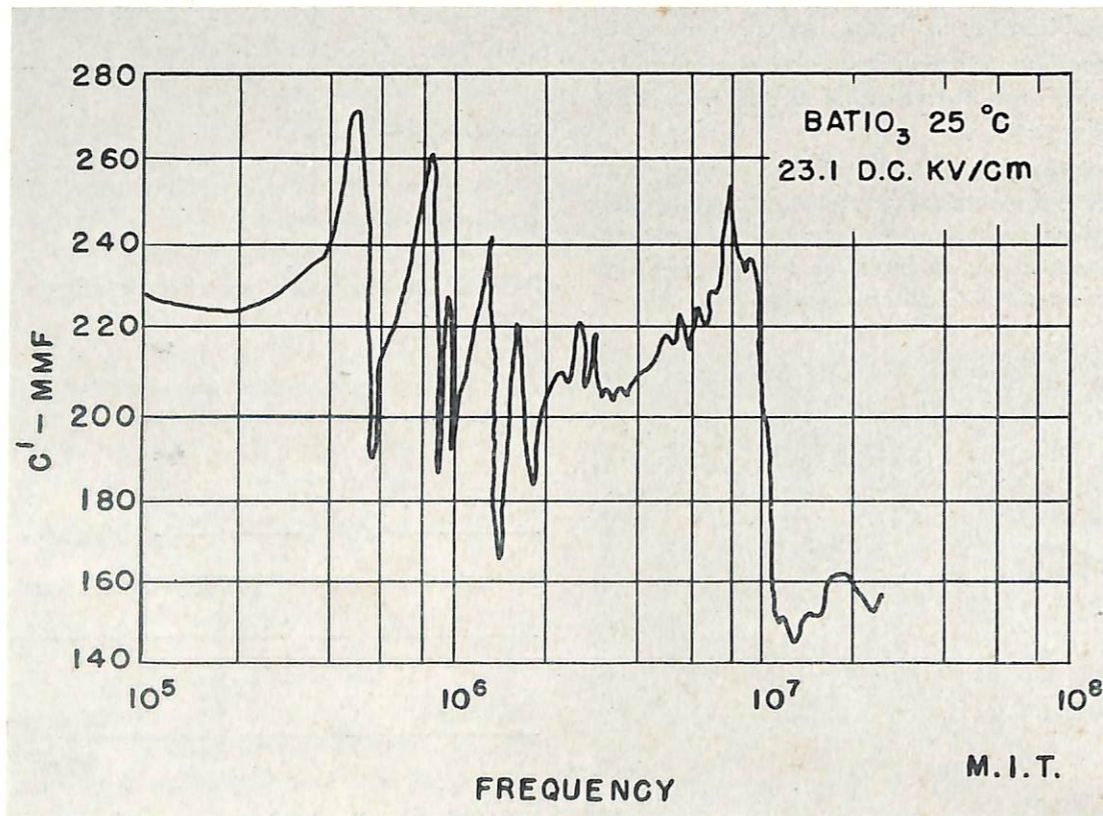

FIGURE 26—Capacitance plotted against frequency, showing resonance peaks in the curve.

Basic receiver principles. Demodulation and filtering details are not included. The overall principles are applicable to both ferro-electric and ferro-magnetic amplifiers.

as the electron tube was just prior to World War I. Many radiomen can still remember when it was necessary to remove the bases from electron tubes to permit them to function at "40 meters" as late as 1925.

Research is continuing, not only with different combinations of mixes as previously mentioned, to produce certain "tailor-made" ferro-electric effects, but is also modifying some of the mixtures to the extent of transforming insulators to exhibit both ferro-electric and magnetic effects.

With the gradual developments of the processes of growing single large crystals of both the ferro-electric and magnetic (ferrites) ceramics, the application perimeters of both the devices will undoubtedly be enlarged.

Applications

Dielectric amplifier applications parallel many of those of the magnetic and tube amplifiers such as a-c and d-c amplifiers for regulators, relays, limiters, servos, instruments, et cetera. Other applications of dielectric capacitors are in differential systems, phase shifters, flip-flop, modulators, multivibrators, sweep generators, filters, thermostats, phonograph pickups, sonar transducers, et cetera.

Many of the above uses are still in the experi-

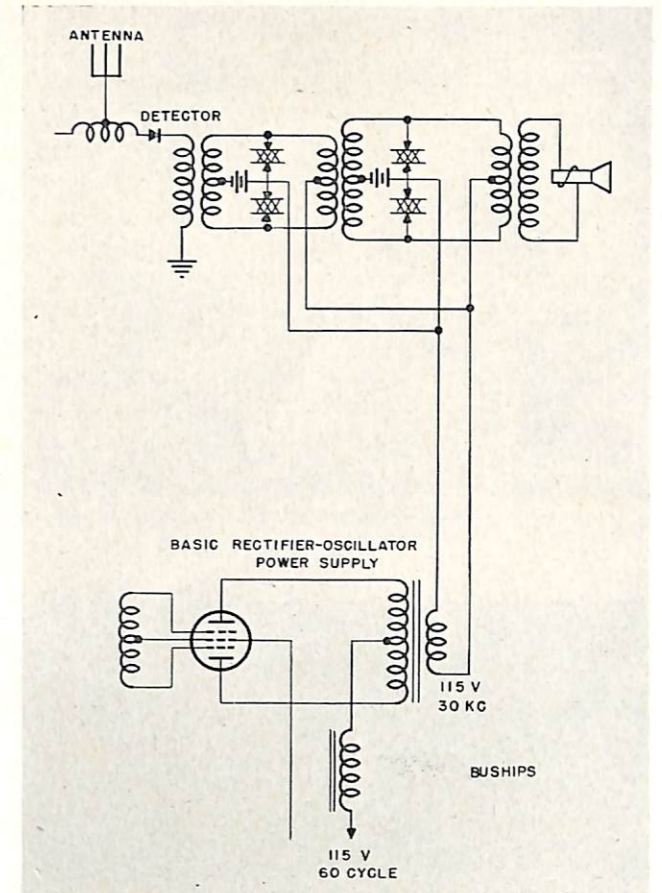

mental stages; others have been developed into practical applications.

Advantages

The dielectric amplifier has many advantages for electronics which are as follows:

No moving parts

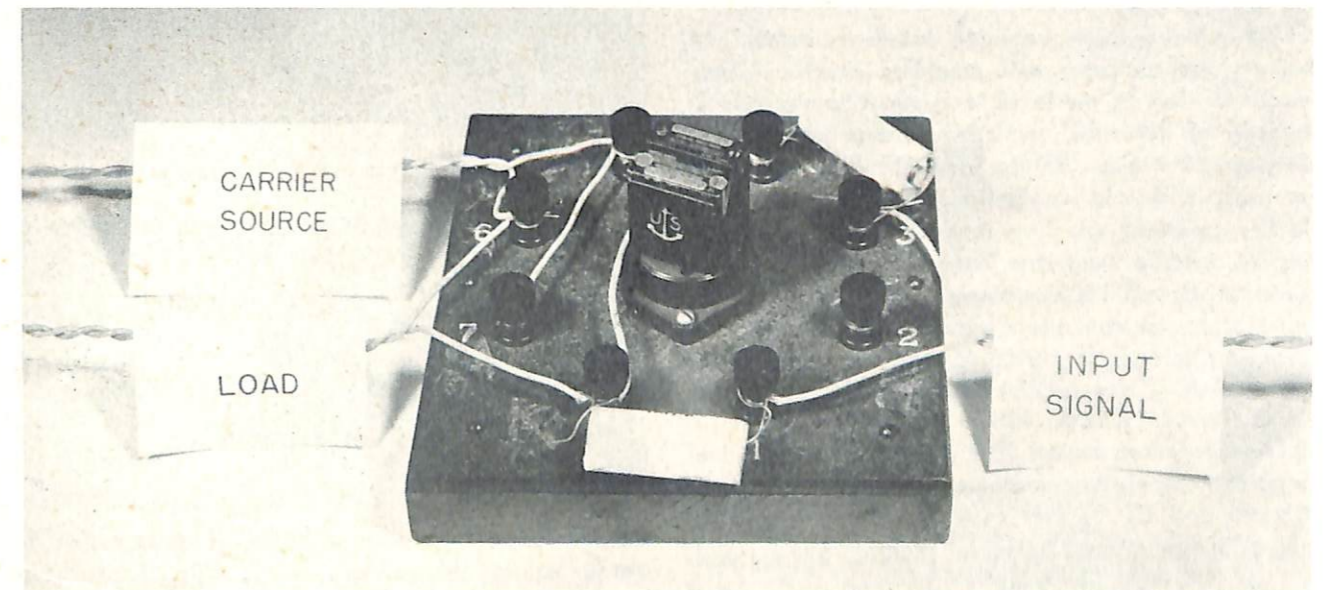

Breadboard setup of a dielectric amplifier.

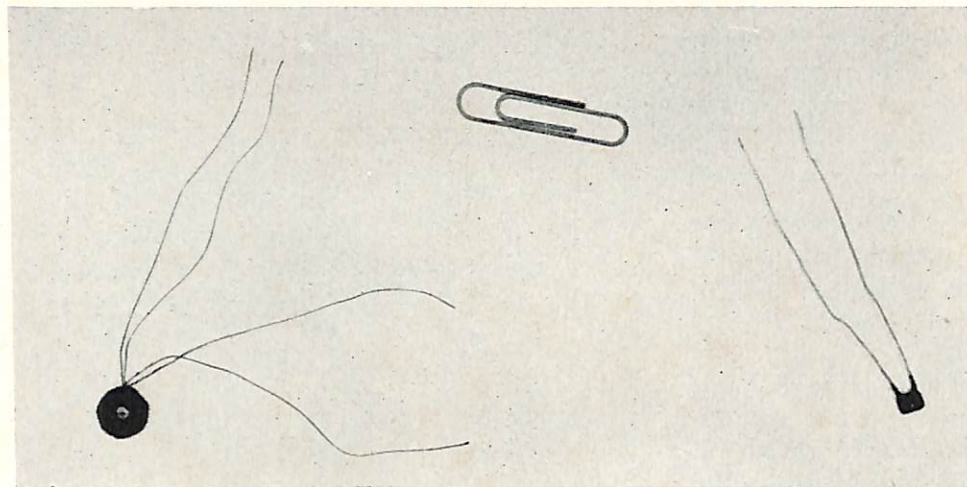

Magnetic and dielectric components designed for 450 kc i-f amplifiers—magnetic on left and dielectric on right.

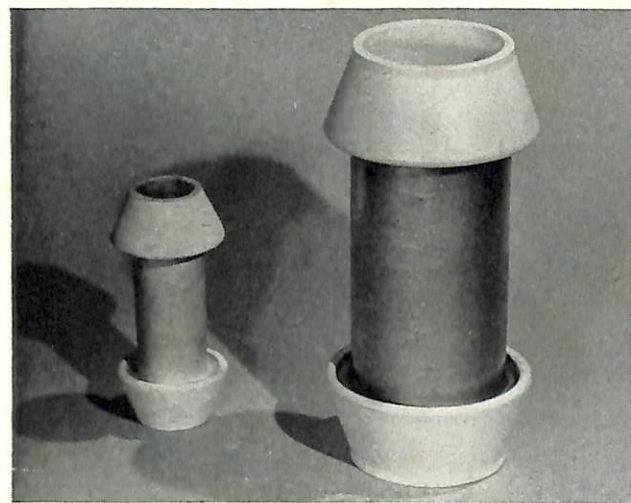

High-voltage, high capacity tubular ceramic capacitors for oscillator and amplifier circuits. Component at left is made of a zircon titanate, has a capacity of 500 mfd, operating voltage 10,000, and will pass 60 kva at 200 kc with 40° C temperature rise without forced ventilation. Ceramic has a dielectric constant of 2, power factor of less than 0.00025 and a negative capacitance temperature characteristic of 100 parts per million per deg C. Larger piece at right has a capacity of 5000 mfd and a working voltage of 10,000 at 4000 kc., passing 400 kva with 40° C rise without forced ventilation. Material is titanium dioxide with a dielectric constant of 88, power factor of less than 0.000 at 1 Mc, and a negative temperature characteristic of 750 parts per 10⁶ per deg C. High-K ceramics give considerable saving in space and weight. Molded by General Ceramics and Steatite Corp.

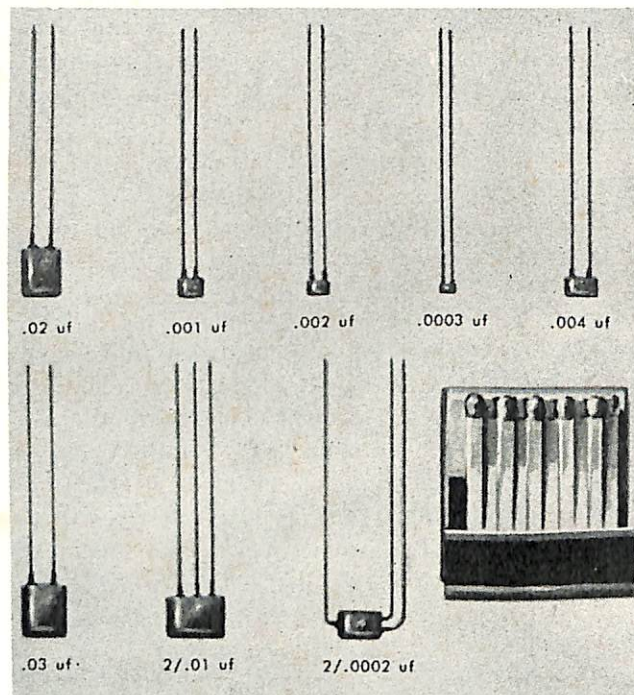

Titanate alloy capacitors made by Glenco Company.

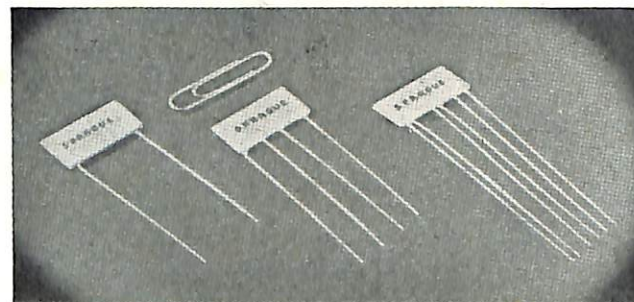

Typical of the application of high-K titanate materials are miniature ceramic capacitors. The K of these titanates used in these Sprague Bulplate series is about 3500.

Ruggedness—practically indestructible
Overload capacity—no filament to burn out
High gain

Safety—no contacts—no filament heat

Adaptability—compact—variety of shapes

Readiness—normally requires no warm up time

Remote controlling—very little power required

Impedance—normally high impedance

Small—In radio-frequency applications requires less space than equivalent tube amplifier

Cost—Considerably cheaper than equivalent tube or magnetic amplifiers. Titanate non-linear capacitors are actually cheaper than either paper or mica condensers.

Frequency range—DC to high frequency.

Disadvantages

Frequency limitations—Indications are that with the dielectric material currently available the upper frequency may be around 10 Mc, although this has not been definitely determined to date.

Curie effect—(The dielectric change due to temperatures)—Currently the titanates have a rather pronounced capacity peak around room temperatures—which would result in a considerable gain drift. This can be compensated for, or compositions with negligible Curie effects and lower gains can be used.

Loading effects—a consideration at high frequency.

Power factor—losses greater than mica or air dielectrics.

Impedance ratio—somewhat limited.

Power limits—closely tied to frequency range.

Aging-lag—Certain dielectric material produced for special effects do have an aging and time lag consideration. The time lag for example is developed for use in certain memory devices. The aging factor is noticed mostly in material developed to produce an extremely high dielectric constant.

Power supply—Like the magnetic amplifier, the dielectric amplifier requires a high frequency power supply—which, until practical dielectric or magnetic multipliers are built, requires a rotary or electronic converter. A single high frequency supply, of course, could be used to supply all electronic equipment, as well as servo and machinery control amplifiers using these devices, throughout the ship.

Conclusions

Although work on dielectric amplifiers has been carried on for some time, emphasis on development of dielectric amplifier circuits has been deferred until recently pending further developments of the basic dielectric material.

Circuitry will be relatively easy and can be based on the techniques used in presently developed magnetic and tube equipment.

These tubeless devices should not be considered as a "cure all" for all electronics ills. Applications should be balanced against advantages and disadvantages over competitive equipment. The major consideration in choosing these components is that of reliability.

The transistor, another competitive tubeless device which has been developed with major strides recently, should also be considered as a compatible component.

The transistor has already been thoroughly covered in various technical publications which makes composite application considerations of the three devices relatively easy.

Acknowledgment

The writer gratefully acknowledges the making available of the basic material and the helpful criticism of Dr. A von Hippel of the Massachusetts Institute of Technology; Dr. R. L. Bright of the Carnegie Institute of Technology and the Office of Naval Research; Dr. V. F. Payne of Squire Signal Laboratory, U. S. Army; Messrs. Madison and Langenwater of General Electric Company; Dr. R. G. Breckenridge of the Bureau of Standards; Mr. C. L. Snider of the General Ceramics and Steatite Corporation; Dr. L. K. Gulton and Mr. G. N. Howatt of Glenco Company; and to Mr. R. T. Williams of the Bureau of Ships who assisted in the preparation of this article; and to Miss K. V. Howell who typed the original material.

Notice to ETM's

Glenco Company of Metuchen, New Jersey will furnish two non-linear condensers suitable for use in amplifiers, at cost, if the request is made on ship's stationery and stating they are to be used for personal experiments. These condensers will be of two capacities, suitable for both r-f and a-f amplifiers and will include a characteristic curve of the dielectrics plotted against both temperature and voltage. One dollar should be included with the request to cover manufacturing cost, handling charges, and postage.

An article on another tubeless device, the RESISTANCE or CRYSTAL amplifier is now being prepared.

Amplification in this instance is accomplished by the effects of a magnetic field on the resistance of a semi-conductor.

This type of amplifier should be more compatible with the transistor in that it will operate on a d-c supply voltage.



ELECTRONIC INTERFERENCE

U.S.S. Princeton (CV-37)

A Field Engineering Survey was made aboard the *U.S.S. Princeton (CV-37)* in an effort to reduce or eliminate electronic interference originating on board, between 10 May 1951 and 8 June 1951. During this period the ship was located in a forward operational area near Korea, with the exception of the period from 21 May 1951 to 31 May 1951, when the ship was at the Yokosuka Naval Shipyard, Japan.

The ship electronics division successfully eliminated most sources of electronic interference before the survey period. This involved considerable time and effort since the ship was recommissioned from the Reserve Fleet so rapidly that this work could not be accomplished during the short recommissioning yard availability.

The most troublesome interference was caused by the high powered communication transmitters, notably the TBM transmitter, in Radio II, on 6690 kilocycles. This interference was found to be a result of a 35-foot section of horizontal exposed antenna lead-in from the forward antenna #9 where the TBM normally operates. (Forward antenna #9 was used because this whip type antenna could be left vertical during flight operations to give maximum communication range. The rest of the antennas must be horizontal during flight operations). However, the electronic interference from the TBM in Radio II was not observed when forward antenna #6 was used. Forward antenna #6 has its lead-in enclosed in a trunk extending from the TBM to the antenna pedestal with no exposed lead-in.

All transmitter antenna insulators exterior to the ship are exposed to heavy salt spray during rough weather or flight operations when the ship is headed into the wind. This results in electronic interference due to arcing and leakage across these antenna insulators. These insulators are also exposed to dirt, oil, and tar blown from aircraft and flight deck when planes are being launched.

Because of very heavy communication demands it is impossible to clean the transmitter antenna insulators as often as necessary. At the present time they are cleaned every fourth day during the replenishment period. These antennas should be cleaned daily to maintain peak operating efficiency.

Any movable metal parts in the vicinity of the transmitting antennas which may be sources of interference are being bonded by the ship electronics division.

A severe harmonic interference was noted. The source of this interference was found to be any one of four Model TCZ transmitters when they were operated in the VLF range. 414 kilocycles is used as a homing beacon for jet aircraft. This frequency is set up on a Model TCZ transmitter and is used whenever the jet planes are flying. Also the TAJ in Radio II on 532 kilocycles, the task force common c-w frequency, was found to be a source of harmonic interference, though to a lesser degree. Table I shows relative values of harmonic output of TCZ transmitters.

Receiving antennas, insulators and associated hardware were found to be in poor condition. These were replaced during the last yard availability at Yokosuka Naval Shipyard, Japan.

The gasoline powered towing equipment aboard, used on the flight deck near receiving antennas, has

no electronic interference suppressor equipment installed.

The following recommendation have been made to reduce or eliminate electronic interference on this vessel:

Frequency Kc	Field Strength uv/m	Quasi Peak uv/m	Peak uv/m	Harmonic	Distance From Antenna
414	1,100,000	1,100,000	1,100,000	Fund.	30 ft.
828	140	140	160	2	100 "
3312	120	120	140	8	100 "
12,834	800	800	960	31	100 "
23,598	400	400	500	57	30 "

1—Install new antenna trunks to satisfy the following conditions:

- a—Relocate transmitters so that the exposed portion of the antenna transmission line is short, i.e. the transmitter is as close to the antenna trunk as possible.
- b—Extend trunk from transmitter to antenna base.

2—Each transmitter whip antenna is supported by eight insulators each of which constitutes a dielectric path to the movable metal base of the whip antenna, which is supported from ground by greased bearing surfaces. It was suggested that each movable metal base of the whip antennas be bonded to the ship's ground.

3—It was suggested that the ship electronics force continue to clean transmitter antenna insulators as often as possible. This should be done every day if practical.

4—It was suggested the TCZ transmitters aboard be replaced with equivalent units that do not have high harmonic outputs.

5—It was suggested that all gasoline powered equipment used on the flight deck have ignition interference suppression equipment installed.

R. E. STRAHL

MK 12 MOD 1

U.S.S. Hank (DD-702)

A fire in the range correction unit, causing smoke and the leakage of tar from transformer T(12)2, resulted from the use of a metal 6L6 tube for V(12)21. The shell of this tube was connected to pin 1, which pin is used for a tie point in this chassis. This resulted in a ground on the +300-volt supply through T(12)2 primary when the shell was grounded. In the absence of any 6L6G tubes in ship's spares, the offending pin was cut off as a

temporary expedient. Replacement of the transformer T(12)2 restored operation to normal.

E. L. PAINE

U.S.S. Powell (DD-686)

After one or two hours of operation, this equipment would begin to lose video presentation on the indicators. It was found that the equipment was running too hot because of inadequate ventilation. Replacing fuses in the main frame blower restored the equipment to normal operation.

L. E. GETGEN

MK 22 MOD 0

U.S.S. Hank (DD-702)

The AFC unit in the receiver circuit was found inoperative. When tube V-501-1 was removed, for adjustment of R-510, all grass and echoes disappeared!

When V-501-1 was reinserted, echoes reappeared and remained even after the i-f input cable was disconnected. It was found that the cables for i-f and enabling pulses had been interchanged. When connected to the proper jacks, no echoes or grass were present. The i-f input lead was found to have been broken off at the bottom of the input jack J-601-1 and was reconnected; normal operation of i-f circuit and AFC resulted. With this lead disconnected i-f signals could be fed into the screen of V-501-1 via the normal enabling pulse lead, coupled to the signal grid by interelectrode capacity, thence into the i-f strip through the common input connection.

E. L. PAINE

QHB-a

U.S.S. Putnam (DD-757)

While making adjustments to the QHB-a it was found that the correct length of the cursor could not be obtained through the normal potentiometer adjustments. By placing 200-ohm resistors across the resistors R 194 and R 195 which are in parallel and are 196 and 197 which are also in parallel, the normal control of the cursor is obtained.

J. W. ELLIS

U.S.S. Putnam (DD-757)

After a period of continuous operation of the attack plotter, it was noted that the east-west sweep length had shortened considerably. A resistance check of the deflection coil revealed that the east-west coil measured 1400 ohms when warm and 2000 ohms when cold. Replacement of the deflection coil was made from yard spares.

J. W. ELLIS

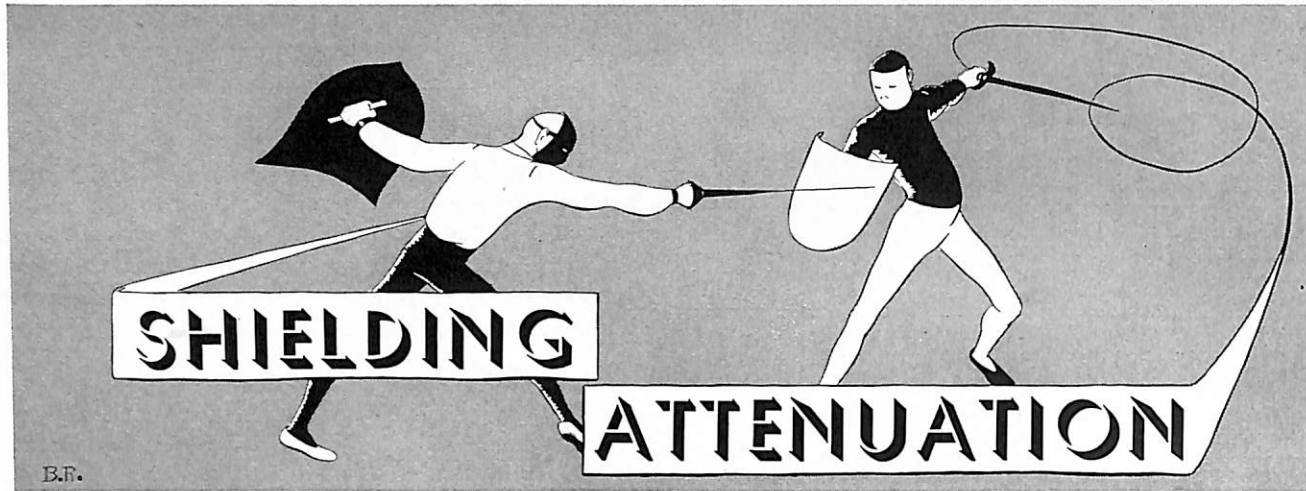

B.F.

by

R. L. HASKINS and A. S. ZAMANAKOS

Electronics Ship and Amphibious Division,
Bureau of Ships

How does an electronic equipment interfere with another electronic equipment which is usually located on the opposite side of the compartment and quite often in completely separate compartments?

This is the problem that confronts us in the radio interference reduction program. We have been accumulating and developing data which will aid us in solving this problem, and will enable you to operate your electronic equipment at the performance levels that were originally intended when the equipments were designed. A typical problem which may be found aboard a submarine, (as taken from a recent report) is as follows: The SV radar interferes with the operation of the WFA-1.

Once this problem appears our question in the opening paragraph is asked. Usually an engineer

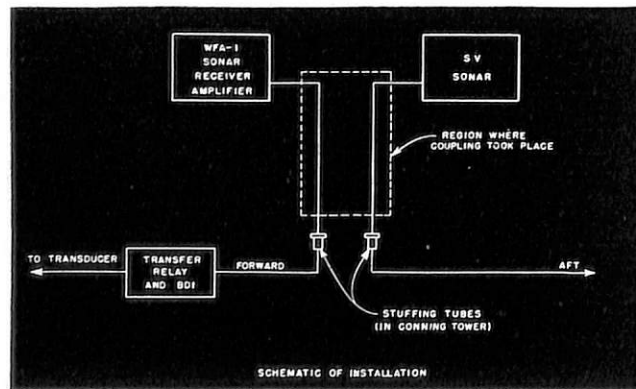

FIGURE 1.

conducts a series of tests which are of a type which will isolate and make evident the form and location of coupling between the two equipments. It is actually a process of elimination that determines the form of coupling.

In this problem it was found that the interference from the SV was coupled to the receiver amplifier of the WFA-1 along a length (6 ft.) of parallel lines belonging to the respective equipments. The SV line was a high voltage line while

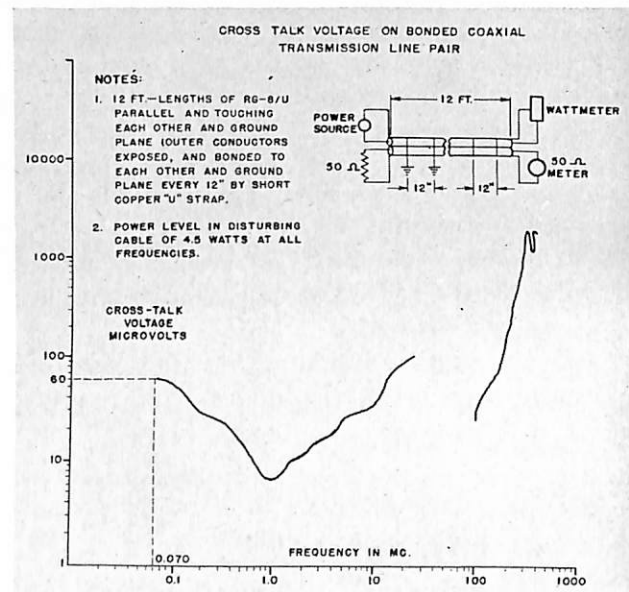

FIGURE 2.

that of the sonar equipment had voltages in the order of microvolts. It was recommended that a belden braid be drawn over this exposed parallel length of the low-level sonar cable to give it protection against the intense r-f fields of the radar cable. It was also suggested that this braid be grounded at both ends and at intermediate points.

These grounds at intermediate points, which are only applied to outer armors or braids, tend to keep the ground loops small and contained and therefore reduce coupling with adjacent circuits.

The data that is in the process of being developed will be such that when an electronic equipment installation is decided upon an engineer will be able to set down certain precautions that are to be taken during construction so that a noise free vessel will ultimately slide down the ways.

Just what will this data be like? It will be a set of factors which will apply to the various types of cables and will be a measure of their protection against r-f fields. These factors will be in decibels so that mere addition and subtraction will enable the engineer to decide on the degree of protection which will be required for certain voltages on adjacent lines.

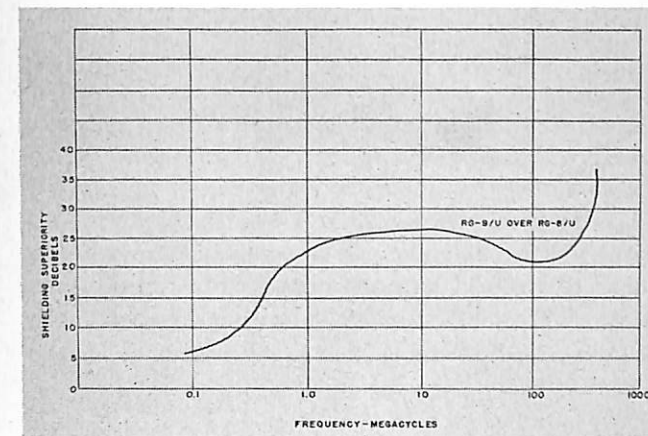

FIGURE 3.

The general idea of this process is as follows: There are 15 volts on a radar trigger cable and parallel to it for a distance of 12 feet, there is a low-level sonar cable whose signal voltage is 5 microvolts. This situation establishes the requirement that there be an attenuation of 130 db between these two voltages and an additional 6 db (minimum) signal-to-noise ratio which should exist in the sonar cable, all this giving a required coupling attenuation of 136 db. From a laboratory experiment, which is mentioned later, we have found that the shields on RG-8/U cables (assumed to be used in this example) provide an attenuation of 60 db each. Based on this controlled laboratory experiment, it was found that 60 microvolts were induced in the adjacent cable when they were side by side. Since the shields only offer a total of 120 db attenuation the additional 16 db must be obtained by other means. The other means being a

physical separation of the cables. We have estimated that with the RG-8/U cables a separation of 13 inches would be required to obtain the signal-to-noise ratio of at least 6 db (see Figure 1).

The Material Laboratory of the New York Naval Shipyard (through their laboratory project 4908-35, Pt 1, Progress Report 2 which was initiated by BuShips Code 837) conducted the experiments upon which these estimates were made, and from which Figures 2 and 3 were obtained.

Figure 3 provides a way out should there not be space available, or for some other reason, to separate the cables the estimated 13 inches; that is, substitute RG-9/U for the RG-8/U and obtain the required increase in shielding by using a more efficiently shielded cable.

Field engineer C. D. Lunden, currently assigned at San Francisco Naval Shipyard, submitted data in which a comparison of RG-8/U, RG-9/U and RG-10/U was made. This is shown as Figure 4.

The variations in values are due to different measuring techniques. The electric and magnetic fields assume varying degrees of importance due to the different measuring techniques and to the distance between the source and receptor. It is these differences in strengths and types of fields that must be considered in shipboard installations. The very nature of the type of installation found aboard a vessel is such as to introduce conditions that usually cannot be duplicated in a laboratory and therefore to be able to directly apply the laboratory results to improving the shipboard installation.

This article is the first one of a series of articles, some of which are Confidential. They present the progress and ideas behind the radio interference reduction program.

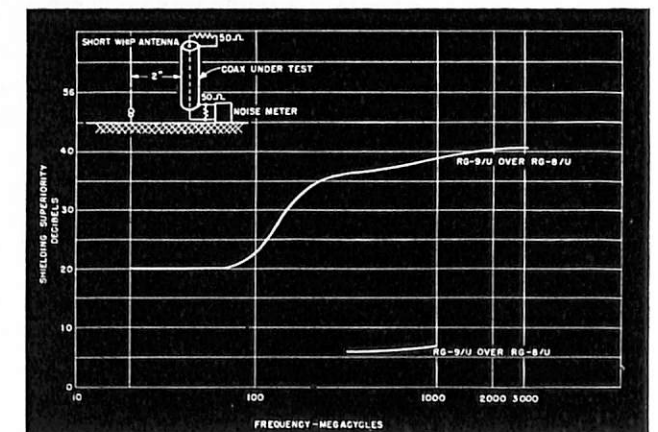

FIGURE 4.

MODERNIZATION OF TRANSMITTING ANTENNA AND GROUND SYSTEM, NAS, LAKEHURST, N.J.



by
LCDR J. R. WARD, USN
U.S. Naval Air Station
Lakehurst, N. J.

During 1950 a special allotment was procured for modernization of the entire antenna and ground system at NAS Lakehurst. The original system was highly inadequate for the extensive operational requirements. After modernizing the

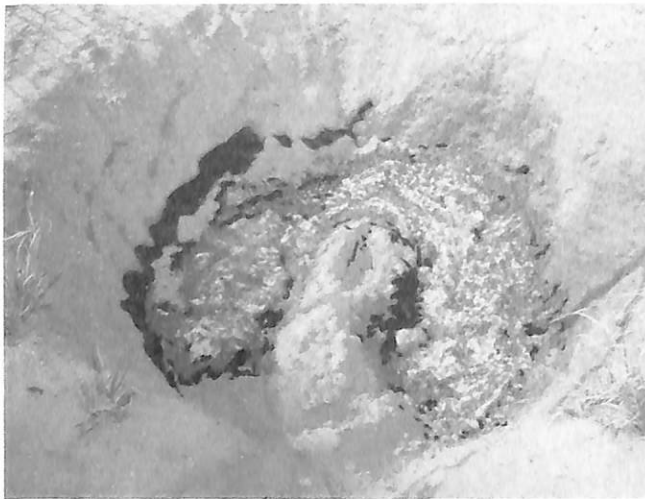

Photograph of ground showing rock salt.

old system, measured results showed an unusually high increase in radiated omni-directional power, as much as 10db over previous measurements.

The old antenna system consisted primarily of straight-wire antennas running parallel in virtually a horizontal plane, and cut to the same random lengths. This introduced extremely high absorption losses and limited transmitter output matching. Also, the horizontal aspect of the antennas caused the radiation pattern to be highly directional.

The transmitters employed are designed to operate with $\frac{1}{4}$ wave-length antennas. The random length of the old antennas caused extremely poor loading. Most of the new antennas are vertically

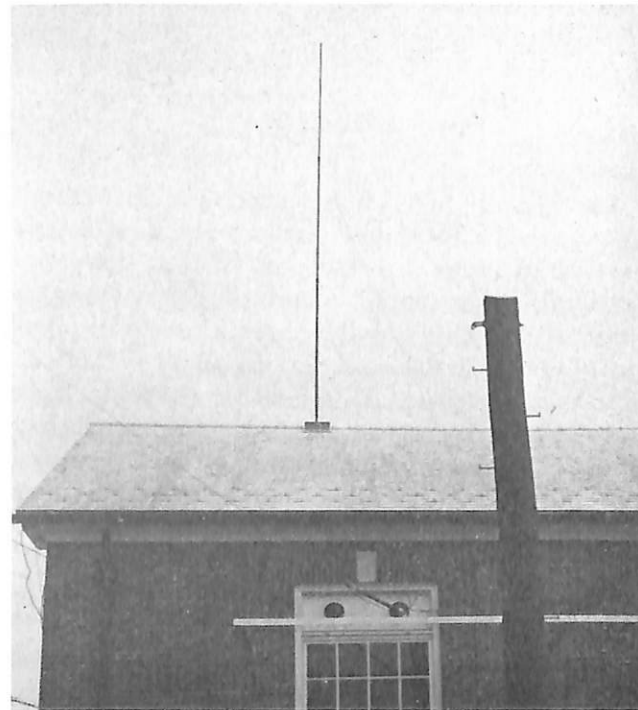

35-foot whip antenna for Model TCA. Note steel base built into roof for support.



View showing vertical aspect of antennas. Six antennas on forward curtain are evenly spaced.

polarized and cut precisely to $\frac{1}{4}$ wave-length of operational frequencies.

Under the old system the TCA and TAB antennas were only five feet apart at the transmitter building. When the TAB was used it became necessary to ground the TCA to prevent feed-back from the TAB. In addition the TCA tended to be bi-directional, and since this transmitter is used for primary tower frequency (3295 kc), the resulting blind spots caused additional requirements of the v-h-f transmitters. The old TCA antenna was replaced with a 35-foot whip and copper tubing leads directly to the TCA. Results are the complete elimination of all blind spots.

The old ground system was unsatisfactory because of the gravel and sand soil in this area. Excerpts from the Bureau of Standards Bulletin (T-108) were used as a guide to measure the resistance of the gravel and sand soil at the transmitter house. Two tests were made at spacings of 6 and 10 feet between two $\frac{3}{4}$ " galvanized pipes driven to a depth of 2 feet, this depth being chosen since the existing counterpoise system at the transmitter house is 18" under the soil. As approved by the Bureau of Standards, alternating current was used in order to avoid the effects of polarization. The average resistance measured and recorded was 6,000 ohms. The Bureau of Standards

lists gravel and sand as the least desirable soil for a good ground, with a maximum resistance that should not exceed 2,700 ohms.

To improve the old ground five chemical grounds were installed by digging a circular trench 6 feet

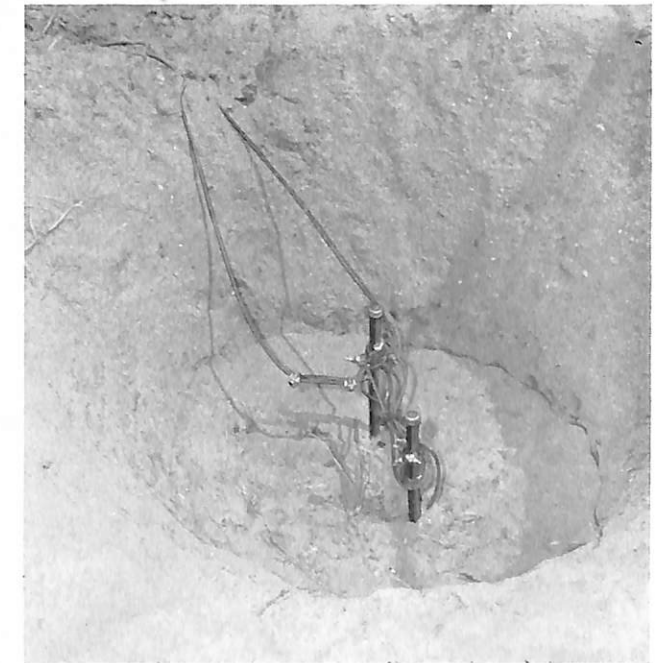

Ground brass rods and interconnecting cables. Note trench without rock salt.

in diameter and 3 feet deep, and driving two 30-foot by one inch rods in the center of these trenches to a water stratum. Rock salt was poured in each trench, the latter watered and covered with a foot of soil. The five chemical grounds were inter-connected with copper cables, which in turn were connected to the existing counterpoise. This

brought the latter to the same potential as the chemical ground system, showed a resistance of only 1800 ohms.

The end result of this improved antenna and ground installation has been excellent communication with all air stations on the east coast and with aircraft operating within a radius of 1500 miles.

SERVICING THE AN/SGC-1 WITH A MINIMUM OF TEST EQUIPMENT

by

B. F. BROWN, ETC, USN
Fleet Training Center,
Pearl Harbor, T. H.

Many of the circuit failures which may occur in the Teletypewriter Terminal Equipment AN/SGC-1 may be isolated easily by visual means. It is equally true, however, that many of the circuit failures may be of an obscure nature requiring a more elaborate means of isolation.

For these more difficult circuit failures the suggested method of defective stage isolation is signal tracing. Signal tracing is accomplished by injecting a signal at the input of the equipment and tracing it through its normal signal path using some form of indicating device. Ordinarily, to signal trace the AN/SGC-1, an audio oscillator and oscilloscope would be required.

During the author's experience in teaching the AN/SGC-1 it has been found that a considerable number of his trainees have been attached to vessels having an inadequate allowance of test equipment to perform signal tracing.

The method of signal tracing to be described was developed by the author to meet the need of a system requiring a minimum of test equipment. The test equipment required with this method is a pair of high impedance headphones and a 1000 ohms-per-volt voltmeter. The headphones are used to isolate the defective stage; the meter is used to isolate the defective component. A test oscilloscope and a vacuum tube voltmeter, though not necessary, are preferable if available.

Usually it is a relatively simple matter to isolate a signal circuit failure to the send or receive section of the terminal. The procedure to be described assumes that the circuit failure has not been isolated to the send or receive section of the equipment. The method may be modified by the technician concerned to fit his need.

An internal feature of the AN/SGC-1 allows its tone oscillator to substitute for the signal generator

which is ordinarily required for signal tracing. With the control switch of the AN/SGC-1 operated to TRS, the tone signal may be traced stage by stage from the tone oscillator to the microphone jack of the associated radio transmitter.

With the control switch operated to ADJ FREQ, the tone signal may be traced from the tone oscillator to the input bandpass filter, Z-101. From Z-101 the signal may be traced stage by stage to the germanium crystals, CR-101 and CR-102.

To test the input transformer, receive level potentiometer, and 6-db pad, jumper the secondary of T-104 to the primary of T-101. The control switch should be operated to TRS for this test.

The high impedance headphones may be used to trace the signal. To do this, connect the headphones in series with a .05-microfarad blocking capacitor. The value is not critical. Anything from .01 to .1 microfarad is satisfactory. Ground one side of the headphones and use the remaining capacitor lead as a probe.

Trace the signal stage by stage from the tone oscillator to the transmitter's microphone jack. The headphones will cause loading on the tone oscillator circuit and will change its frequency. This may be disregarded.

In order for V-106 to show a gain, the second level potentiometer should be adjusted completely clockwise. T-103, Z-103, the 6-db pad, and T-104 will indicate a slight loss of signal. This is normal. A complete loss, or near complete loss, of signal at any of the above points is an indication of trouble.

If the send circuits are operating correctly, turn the control switch to ADJ FREQ. Trace the signal from Z-101 to the germanium crystals, CR-101 and CR-102. Transformer T-102 will show a loss of signal on its secondary due to headphone loading. The 470-k resistor in the grid circuit of each limiter-amplifier will also cause a loss of signal.

The thing to look for here is a gain when going from grid to plate on the same tube. When going

from the plate of one stage to the grid of the following stage, a loss of signal should be expected. Any complete loss or near complete loss of signal, where there should be a gain, indicates trouble.

With T-104 jumpered to T-101 it is possible to test T-101, E-101, and the receiving 6-db pad. Operate the control switch to TRS for this test. The receive level attenuator should be turned completely clockwise. No loss of signal should be noted except in the 6-db pad.

The above tests allow the entire signal circuits of the terminal to be signal traced with nothing more than a pair of headphones. A test oscilloscope, if available, allows a more accurate signal tracing test to be performed.

When the defective stage has been isolated, a

test meter may be used to locate the defective component. If a 1000 ohms-per-volt voltmeter is used, it should be remembered that it will cause considerable voltmeter loading with consequent low readings. This effect may be minimized by always using the highest scale reading which will give a readable indication. If a vacuum tube voltmeter is available, voltmeter loading may be disregarded.

For the technician faced with inadequate test equipment, the described method of signal tracing is a practical way to find circuit failures reliably, quickly, and accurately. If followed carefully, defective stages and defective components may be found much more quickly than by taking a complete set of voltage or resistance measurements.



In a letter to the Bureau of Ships, from a DDE, a comment was made concerning certain test equipments on the DDE allowance which were not usable since the radars with which the test equipments were to be used were not installed. The test equipments mentioned were the Navy Type 60ABM for MK28 radar, Navy Models OAA and OAW for SC radar, the Echo Box TS-349/UP for MK12 radar and Navy Model OBU for MK28 radar and SG through SG1b radars.

The above mentioned test equipments are listed in the Electronic Type Allowance List for DDE's, with a notation on the list that these equipments are to be used with certain radars only—i.e., Type 60ABM Wavemeter (for MK28-2 only). This means that when the MK28 Mod 2 radar is not aboard, the Navy Type 60ABM is not allowed. In the case of this particular DDE therefore, the above-mentioned test equipments are "in excess" of allowance and should be turned in to the nearest electronics supply activity.

TYPE 23496 REMOTE CHANNEL SELECTOR INDICATOR UNIT

The Bureau has been advised that in some installations the remote channel selection facility of the Type 23496 remote channel selector indicator unit has been removed by disconnecting or disabling this circuit in the control unit. The reason for this is not clear. Where removal of this facility is necessary, it should be accomplished by disconnecting the circuit at the remote transfer panel (or switchboard) or at the equipment if transfer panels are not used. Wiring in the 23496 remote unit should be left intact.

MODEL VF OVEN THERMOMETERS

Oven thermometers for the Model VF radar repeater are now available.

As outlined in the Model VF instruction book, NavShips 900,858, the temperature of the oven should be checked once a week. This is an excellent preventive maintenance procedure and should decrease the number of failures involving the oven assembly and its parts.

This thermometer is presently stocked as follows: 300 at Naval Supply Depot, Bayonne, New Jersey; 300 at Naval Supply Center, Norfolk, Virginia; and 400 at Naval Supply Center, Oakland, California. They can be ordered through routine supply channels by the following stock number and nomenclature: N18-T-3095-115 Thermometer, 0 to 100 degrees Centigrade, 5-inch stem, Weston Model 2261, U/W VF repeater.

Modernization F.C. Kit for the Model OZ

Since a sufficient number of Tube Testers TV-3/U are not available at the present time to replace all Navy Model OZ series, the Bureau of Ships has procured approximately 900 field change kits for the modernization of Model OZ series equipments. The accomplishment of the field change will permit the testing of many new type tubes which cannot be tested presently by the Model OZ series equipments. Navy Field Change No. 1-OZ-1, No. 1-OZ-2 entitled "Installation of Normal-Low Signal Switch and Tube Socket Adapter MX-1123/U" consists of the following:

- 1—Adapter Unit MX-1123/U
- 2—One switch assembly
- 3—Two test leads
- 4—One lighthouse adapter
- 5—Two instruction book supplements

The adapter unit can be stowed in the lead compartment of the Model OZ series tube tester. It receives all necessary test voltages through a cable terminated in an eight-pin plug for insertion into

the octal test socket on the panel of the tube tester. A group of six sockets on the panel of the adapter will accommodate the newer type tubes, and the application of correct test voltages to the proper pins is accomplished by means of seven selector switches also located on the adapter panel. Two test leads serving as grid and plate connections and an adapter for lighthouse tubes are supplied as accessories with the tube socket adapter.

The switch assembly which consists of a toggle switch with two resistors and appropriate wiring already attached is to be installed in the tube tester in accordance with instructions furnished.

The supplementary instruction book describes the new adapter and gives complete up-to-date and revised tube data information for all current receiving types of tubes.

Since the number of field change kits is limited, it is requested that only tube testers in good electrical and mechanical condition be modified.

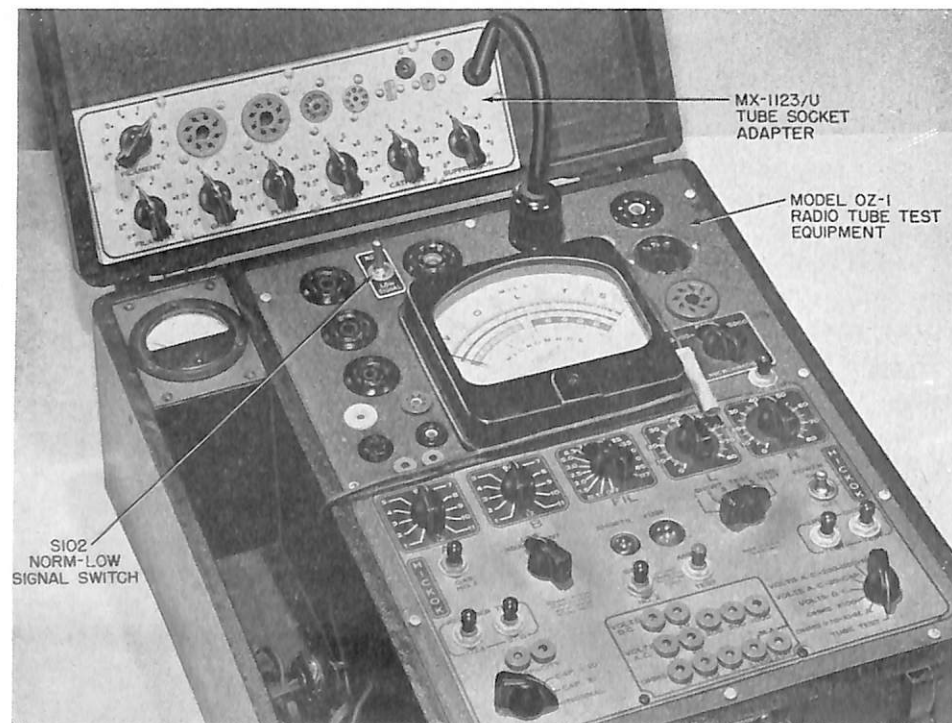

FIGURE 1.

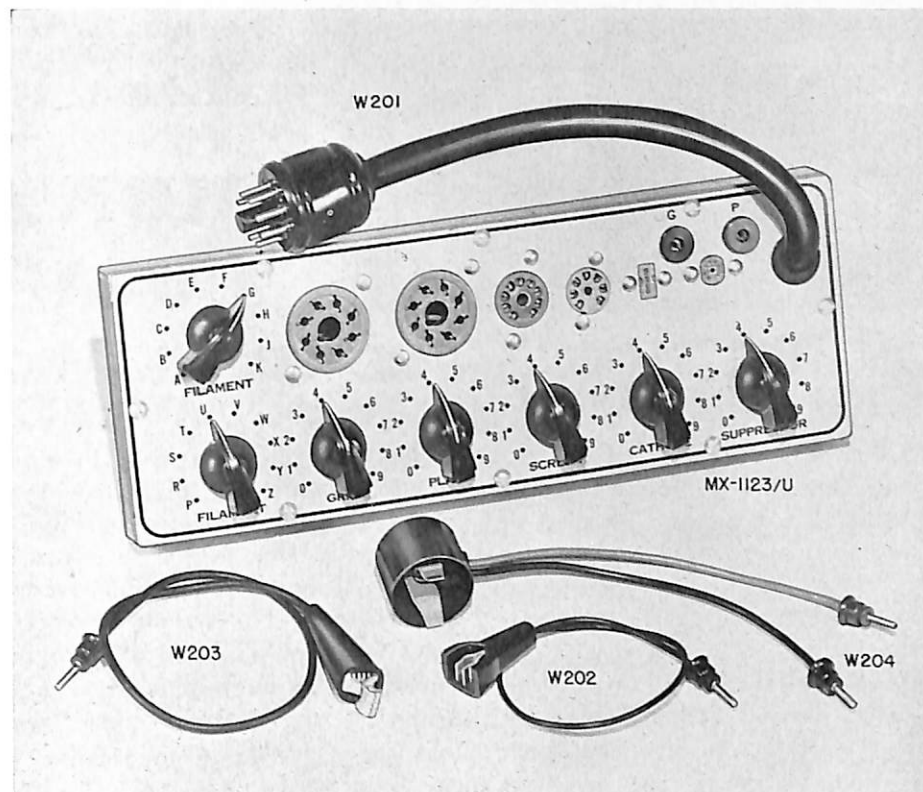

FIGURE 2.

The symbol designations of the test leads as indicated on Page 3 of NavShips 98199 Electronics Field Change Bulletin No. 1-OZ, No. 1-OZ-1, No. 1-OZ-2 and in Table 6-1 (Page 6-5 and 6-6) of the Supplementary Instruction Book, NavShips 95198-1, 900,346-1B-2, 05200-1 are in error. W-201, W-202, and W-203 of the Field Change Bul-

letin should be corrected to W-202, W-203, and W-204 respectively. W-201, W-202, W-203 and W-204 of Table 6-1 should be corrected to W-202, W-203, W-204, and W-201 respectively. The correct symbol designations are shown in Figure 1-2, Page 1-3 and in Table 1-3 on Page 1-2 of the supplementary instruction book.

DBM-1 ANTENNA ROTATION FAILURES

Two major failures of the CBM-66141 and CBM-66142 antennas, part of the Radar Direction Finder Equipment Model DBM-1, have been occurring because of improper use of the ANTENNA SPEED CONTROL. These failures consist of the burning out of the antenna drive motor and the collapse of the counter-weight support members of the antenna. The burning out of the antenna drive motor results from setting the ANTENNA SPEED CONTROL at too low a voltage so that the drive motor lacks sufficient power to begin rotating. The latter and more prevalent trouble stems from too high a setting of the Variac, causing the antenna to rotate at such a high speed that the counter-weight structure is torn loose.

The speed stops on the Variac should be checked regularly to make certain that they are set correctly and are not broken. Check the output of the Variac with a voltmeter and then set the speed stops so that the low-speed stop is adjusted to produce not less than 30 volts output from the Variac and the high-speed stop is adjusted to produce no more than 87 volts. Frequently the antenna does not start to rotate with a Variac setting of 30 volts. This can result in damage to the motor. If this difficulty is experienced, set the low-speed stop at 35 volts output from the Variac, or at such voltage output as will insure the starting of the rotation of the antenna at all times.

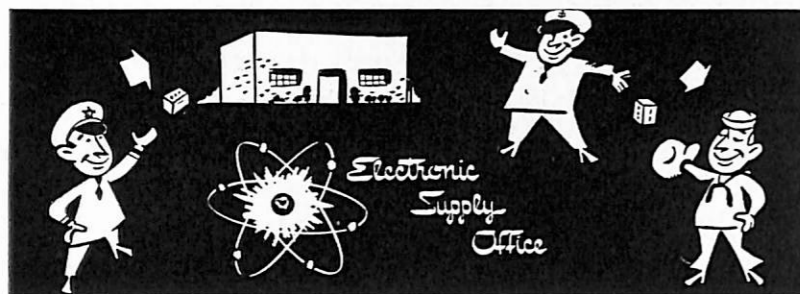

ELECTRON TUBE STOCK PURIFICATION PROGRAM

BuShips Project No. 597000/50, for testing electron tubes, has been assigned to the Electronic Supply Office. The ESO has initiated a program to clear defective tubes from warehouse stock in the Electronic Supply System. Tubes may become inoperative from various causes—air leak, open filament, low emission, short circuit, gas, etc.

These tests are being conducted at the various supply activities using several different types of testing equipment. The tests on receiving tubes are made primarily on the special multiple tube testers developed by the San Francisco Naval Shipyard Navy Type MT-938/G. It is patterned after a model previously made by SSD, NSC Oakland. An auxiliary testing device is furnished for use in making a quick test for the presence of gas in any tubes having glass envelopes. This tester is of the high voltage type, and is sometimes called the Tesla coil or corona test.

The larger multiple tube tester has been purchased in a total quantity of 16, and an additional one was made by SSD, NSC Oakland. These have been distributed to the activities having the larger quantities of tubes, and technical personnel available to assist in tests. The high voltage gas detector was purchased in much larger numbers and distributed to all supply activities stocking vacuum tubes in large quantities. The multiple tube tester is capable of testing practically all receiving type electron tubes and the low power transmitter types. It is said to be capable of testing 1500 tubes per hour, with an assembly line organization.

The tests are being conducted on a sampling basis (in accordance with JAN-1A, 15 Mar 1951) and when types of tubes or lots indicate a high percentage of defective units, the complete lot should be tested. Additional tube testers are being developed for transmitting tubes, magnetrons and other special types. Specifications are under preparation at the Material Laboratory, New York Naval Shipyard for the magnetron tester and several special types to be manufactured later.

E.S.O. MONTHLY COLUMN

THE IDENTIFICATION AND INVENTORY PROGRAM

The identification and inventory program is another step in a plan to identify and make available to the Electronic Supply System stock which has been frozen because it has no stock number. The activation of Reserve Fleet vessels as a result of the Korean emergency demonstrated the need for extension of such a program to the vessels remaining in an inactive status. Like the vessels activated, these others have large quantities of electronic spares stowed aboard which will have to be identified eventually. The provision of sufficient stock to fill deficiencies that will exist in their allowance upon activation is a supply problem that must receive timely consideration.

Work has begun at all Reserve Fleet Groups to accomplish these objectives. Contractor teams have been provided who will identify and stock number spare parts and prepare an inventory of equipments (if desired by Reserve Fleet Commanders) and spare parts found aboard Reserve Fleet vessels. They will, in effect, ready the ships for operations in all respects except for the provision of a full allowance of electronic spare parts. The data obtained in the course of the program will enable this last step to be taken with relative ease.

Normally the spare parts identified and inventoried will be restored in the same boxes from which they are removed. However, it is planned that vessels which will undergo quinquennial overhaul during the program will be equipped with bins as soon as sufficient stocks are available.

Inventories of spare parts by equipment taken by contractor teams will be forwarded to the Electronic Supply Office, where a combined inventory for each vessel will be prepared. From these, studies will be made to determine the requirements of each area in the event of partial or total mobilization of the Reserve Fleet. On the basis of such studies, it will be possible to provide supply support activities an adequate range of stock in sufficient quantity to assure prompt and efficient service in the event of mobilization.

IN MEMORIAM

M. Abraham A. Cory received his B.S. and M.S. degrees in Electrical Engineering from the University of North Carolina in 1926 and 1928.

He started with the Radio Material Office, Norfolk Navy Yard in 1930 as Assistant Radio Engineer and had uninterrupted service until the time of his death. Mr. Cory became interested about 1938 in developing a means of controlling shipboard radio direction finder deviations at intermediate frequencies and originated a "crossed loop" method of accomplishing this. Although successful, only a few shipboard installations were made due to the adoption of the Bellini-Tosi type loop by the Navy. However, the information obtained from these deviation investigations suggested a method of accurately locating planes of low deviation aboard ship. Direction finding loop antennas for low and intermediate-frequency equipments may now be installed without resorting to the usual corrector loops which result in losses of sensitivity.

During many of the depression years, when the Navy was at its lowest strength, Mr. Cory was the sole radio engineer of the radio organization at the Norfolk Naval Shipyard. With the expansion of the Navy immediately preceding World War II, he started to assemble the nucleus of the present Electronics Office staff. As Chief Civilian Assistant of the Electronics Officer he was responsible for coordinating and reviewing the priorities of electronic work performed by the shipyard and supervising and coordinating the work of the civilian Electronics Office staff.

Mr. Cory died on the twenty-ninth of September, 1951.

STATUS OF NAVSHIPS 900,123, 900,116, 900,105 AND EPIS

The List of Naval Electronic Equipment, NavShips 900,123, and its supplement are being combined and information on new equipments and components added to make a new revised List of Naval Electronic Equipment, NavShips 900,123A. It is estimated that distribution will be made before the summer of 1952.

The Catalogue of Electronic Equipment, NavShips 900,116, and its supplement are being completely revised under contract to cover all equipments and when completed will be published as Part III of the BuShips Section of the Catalogue of Naval Material. It is estimated that distribution will be made in the spring of 1952.

The Catalogue of Electronic Test Equipment, NavShips 900,105, will be incorporated into the Catalogue of Electronic Equipment.

Electronic Planning and Information Survey (EPIS) Sheets (or letters) are again being prepared and will be issued very shortly. It is planned to continue their issue until the new "List" or "Catalogue" is distributed.

In "USN USL Notes" in the October 1951 ELECTRON, the last sentence of the next-to-the-last paragraph should read "If it is possible to work into a high impedance load, no phase change will take place."

Supplementary sheets for the "Catalogue" have been required on all new equipment contracts originated since April 1951.

REINSERTION OF R(2)75 IN THE SV/-1/-2

From investigations made by the Bureau of Ships it has been determined that the presence of the arc suppression resistor R(2)75 in the modulator tube circuit of the CW-43 ACW transmitter-receiver tends to keep the high voltage across the 5D21 tubes at a minimum during arcing within these tubes and thereby reduces possible failures of the 5D21 tubes and the modulator network.

Due to the original shortage of this resistor the Bureau of Ships authorized its removal from the circuit. At the time of removal of this resistor, leads connected to Terminal No. 3 of plate transformer T-1(KS-9668) were to be removed and connected to Terminal No. 4 of the same transformer.

As there is at present a sufficient supply of this resistor in stock to maintain the present number of active equipments, it is requested that R(2)75 be reinserted in the modulator tube circuit and the lead connected to Terminal No. 4 of the plate transformer (T-1) be reconnected to Terminal No. 3 of the transformer.

ERROR IN F.C. NO. 12— QCQ-2/QGB BULLETIN

The Long Beach Naval Shipyard has reported an error in Figure 14 of NavShips 900,072, the instruction bulletin for Field Change No. 12—QCQ-2/QGB. When the equipment is connected as shown in Figure 14, an abnormally high reading is obtained on Meter M-104 and a beam pattern measurement shows a wide platter-shaped beam which curves to port. The error is in the connection between the filter junction box and the QGB keying relay, K-105. The correct connection is as follows:

1—Lead 4C connects Terminal U8 in the filter junction box to Terminal 6 of the keying relay, K-105.

2—Lead 2C connects Terminal U7 to Terminal 10 of K-105.

3—Lead 1C connects Terminal U6 to Terminal 7 of K-105.

It is not expected that all QGB's will have this error, as the QGB interconnection diagram given in Figure 16 of Navships 900,072 shows the correct connections.

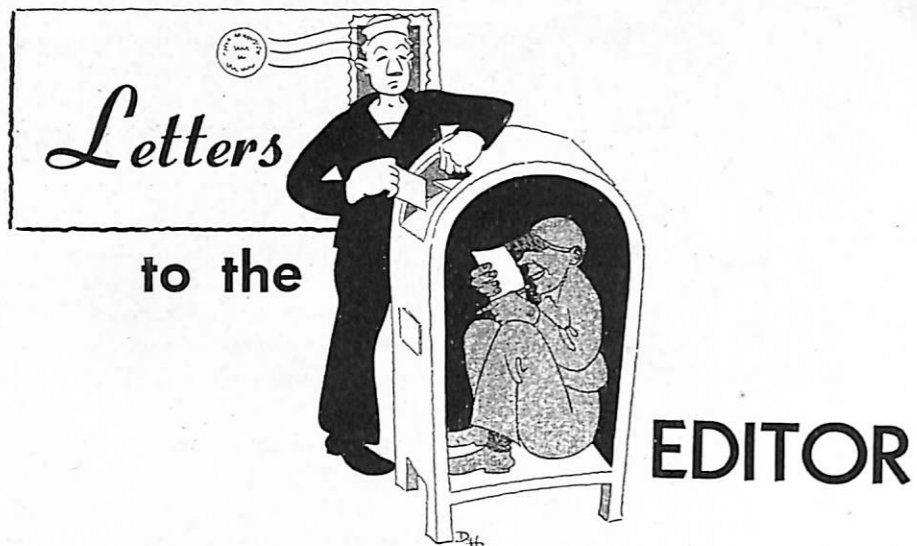

This new feature is the answer to numerous suggestions and requests from fleet and shore personnel for a medium of presenting their individual problems, gripes and questions on electronics matters and obtaining answers to such queries.

As a matter of convenience, it is suggested you write directly to:

The following is typical of the type of letters received to date for inclusion in this column:

The Editor
 BuShips Electron
 Code 993
 Bureau of Ships
 Navy Department
 Washington 25, D. C.

The following two letters are on the same subject:

Editor
 BU SHIPS ELECTRON
 Sir:

Where can I obtain an up-to-date list of teletypewriter equipment?

I need a complete list of all equipment with a description of each type indicating Navy Type designators.
 Lt. J. M. T., USN

If this catalogue is available, the NavShips number and title are requested to enable ordering of catalogue.
 D. V. V., EO

A comprehensive current list or catalogue of teletype equipment is being prepared by the Bureau of Ships. Announcement of the availability of this list will appear promptly in BU SHIPS ELECTRON. Pending announcement the list appearing under the heading "JAN Teletype Nomenclature" in BU SHIPS ELECTRON, February 1950 applies. Requests for information on specific equipments which have been distributed subsequent to the referenced article should be addressed to the cognizant technical code at the Bureau of Ships.

Editor

Editor
 BU SHIPS ELECTRON
 Sir:

The February 1950 ELECTRON (Page 19) published a list of JAN teletype nomenclature and stated a complete list would be issued at a later date in the form of a catalogue.

LET'S TALK



Turkey!

**DON'T FEAR THE AXE!!!
 SEND IN A COMPLETE FAILURE
 REPORT CARD (NavShips 383)
 FOR EVERY FAILURE OF YOUR
 ELECTRONIC EQUIPMENT**

Miller

RESTRICTED

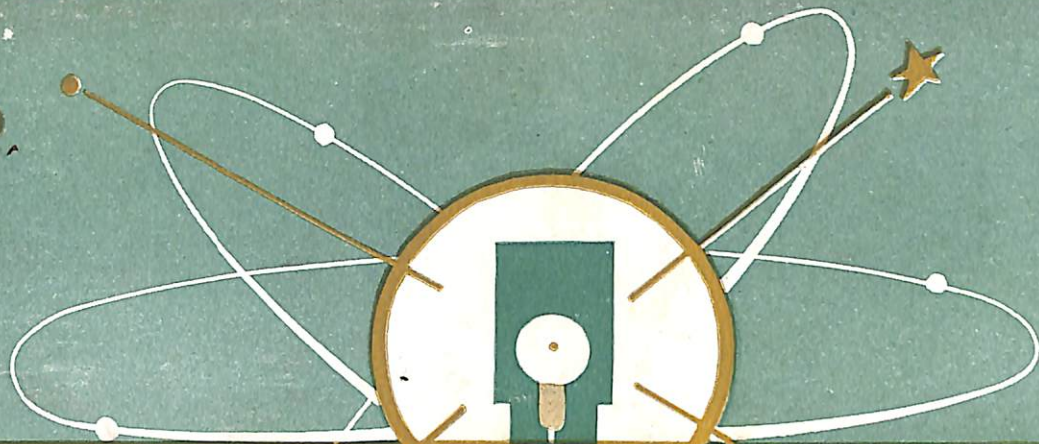

ELECTRONICS rings the bell!



RESTRICTED

